

# Makita®

# 2022

ACCESSORY CATALOGUE



## Safety Precautions

When using electric tools, basic safety precautions should always be followed to reduce the risk of fire, electric shock, and personal injury, including the following.

### /// KEEP WORK AREA CLEAN.

Cluttered areas and benches invite injuries.

### /// CONSIDER WORK AREA ENVIRONMENT.

Don't use power tools in damp or wet locations. Keep work area well lit. Don't expose power tools to rain. Don't use power tool in presence of flammable liquids or gases.

### /// KEEP CHILDREN AWAY.

All visitors should be kept away from work area. Don't let visitors touch the tool or extension cord.

### /// STORE IDLE TOOLS.

When not in use, tools should be stored in a dry, high of locked up place, out of reach of children.

### /// DON'T FORCE THE TOOL.

It will do the job better and safer at the rate for which it was intended.

### /// USE THE RIGHT TOOL.

Don't force small tools or attachments to do the job of a heavy-duty tool. Don't use tools for purposes not intended.

### /// DRESS PROPERLY.

Don't wear loose clothing or jewelry. They can be caught in moving parts. Rubber gloves and non-skid footwear are recommended when working outdoors. Wear protective hair covering to contain long hair.

### /// USE SAFETY GLASSES.

Also use face or dust mask if the cutting operation is dusty.

### /// DON'T ABUSE THE CORD.

Never carry the tool by the cord or yank it to disconnect it from the socket. Keep the cord away from heat, oil, and sharp edges.

### /// SECURE WORK.

Use clamps or a vise to hold the work. It's safer than using your hand and it frees both hands to operate the tool.

### /// DON'T OVERREACH.

Keep proper footing and balance at all times.

### /// MAINTAIN TOOLS WITH CARE.

Keep cutting tools sharp and clean for better and safer performance. Follow instructions for lubrication and changing accessories. Inspect tool cord periodically and if damaged, have it repaired by an authorized service facility. Inspect extension cords periodically and replace, if damaged. Keep handles dry, clean and free from oil and grease.

### /// DISCONNECT TOOLS.

When not in use, before servicing and when changing accessories such as blades, bits and cutters.

### /// REMOVE ADJUSTING KEYS AND WRENCHES.

Form the habit of checking to see that keys and adjusting wrenches are removed from the tool before turning it on.

### /// AVOID UNINTENTIONAL STARTING.

Don't carry a plugged-in tool with a finger on the switch. Ensure switch is OFF when plugging in.

### /// USE OUTDOOR EXTENSION CORDS.

When tool is used outdoors, use only extension cords intended for outdoor use.

### /// STAY ALERT.

Watch what you are doing. Use common sense. Don't operate tool when you are tired.

### /// CHECK DAMAGED PARTS.

Before further use of the tool, a guard or other part that is damaged should be carefully checked to determine that it will operate properly and perform its intended function. Check for alignment of moving parts, free running of moving parts, breakage of parts, mounting and any other conditions that may affect its operation. A guard or other part that is damaged should be properly repaired or replaced by an authorized service center unless otherwise indicated in this instruction manual. Have defective switches replaced by an authorized service facility. Don't use the tool if the switch does not turn it on and off.

### /// GUARD AGAINST ELECTRIC SHOCK.

Avoid body contact with earthed or grounded surfaces (e.g. pipes, radiators, ranges, refrigerators).

### /// REPLACEMENT PARTS.

When servicing a tool, use only identical replacement parts.

### /// VOLTAGE WARNING:

Before connecting the tool to a power source (receptacle, outlet, etc.) Be sure the voltage supplied is the same as that specified on the nameplate of the tool. A power source with voltage greater than that specified for the tool can result in SERIOUS INJURY to the user V as well as damage to the tool. If in doubt, DO NOT PLUG IN THE TOOL. Using a power source with voltage less than the nameplate rating is harmful to the motor.

## Note

- Makita reserves the right to change specifications of parts and accessories without notice.
- Items of standard equipment and specifications may vary by country or area.
- Net weight and dimensions may differ by the type of battery.
- Standard export color for motor housing is Makita industrial green (blue).
- Please state required voltage when ordering. These offers are subject to availability in each country. Actual product color may differ slightly from color reproduced here.
- The weight may differ depending on the attachment(s), including the battery cartridge. The lightest and heaviest combination, according to EPTA-Procedure 01/2014

## Guarantee





Every Makita tool is thoroughly inspected and tested before leaving the factory. It is guaranteed against defective workmanship and materials. Should any trouble develop, return the COMPLETE tool prepaid to Makita or point of purchase. If inspection shows trouble is caused by defective workmanship of material, all repairs will be made without charge. The guarantee does not apply where repairs have been made or attempted by others; repairs are due to normal wear; the tool has been abused or in an accident; misuse is evident – caused by overloading the tool beyond its capacity, use of the tool after partial failure or use with improper accessories.

# Safety









-  Wear eye protection
-  Wear ear protection
-  Wear a mask
-  Wear protective gloves
-  Wear protective shoes
-  Read the instruction manuals
-  Remove plug from socket

# Materials









## Stone

-  Reinforced concrete
-  Concrete
-  Red brick
-  Brick
-  Porous concrete











## Wood











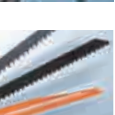

-  Wood
-  Wood with nails
-  Pallet
-  Laminate
-  Sandwich panel
-  Plywood
-  Veneered wood
-  Sandwich material
-  Chipboard

## Metal

-  Metal
-  Metal plates
-  Aluminum
-  Sheet metal
-  Non-ferrous metals
-  Metal & Stainless
-  Stainless steel
-  Cast iron

## Other Materials

-  Glass fibre reinforced plastic, epoxy
-  Glass
-  Wood and plastic combined
-  Ceramic tiles
-  Plastic
-  Fiber cement board
-  Perspex
-  Aerated concrete block
-  Wood and metal
-  Plaster board

Drilling (Wood/Metal)	10	
Drilling (Masonry)	36	
Fastening	59	
Drill and Screw Bit Sets	73	
Cutting	76	
Jigsaw / Reciprosawing	91	
Brushing	104	
Bonded Abrasive	111	
Coated Abrasive	122	
Multi Tool	133	
Diamond	144	
Planing / Routering	160	
OPE	170	
Miscellaneous	187	

**Screwing/Drilling**

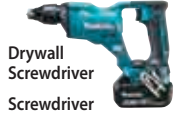

**Fastening P.59**



**Drilling (Wood/Metal) P.10**



**Brushing P.104**



**Drilling (Masonry) P.36**



**Diamond P.144**



**Fastening P.59**



**Drilling (Wood/Metal) P.10**

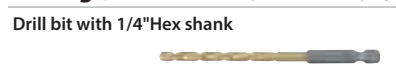

**Drilling (Masonry) P.36**



**Fastening P.59**

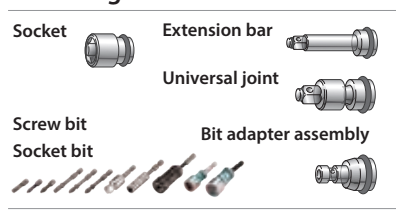

**Fastening P.59**



**Miscellaneous P.187**



**Stirring**



**Miscellaneous P.187**



**Hammer drilling/Chiselling**



**Drilling (Wood/Metal) P.10**

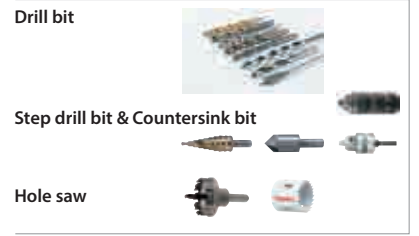

**Diamond P.144**



**Drilling (Masonry) P.36**

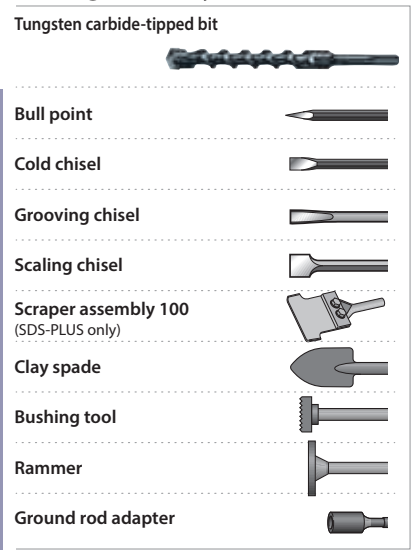

**Cutting**



**Diamond P.144**



**Bonded Abrasive P.111**

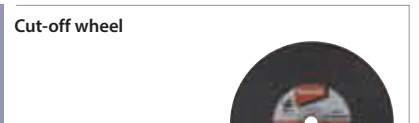



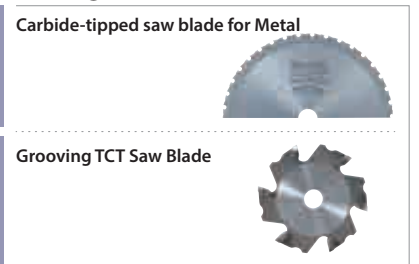





**Cutting P.76**



**Jigsaw / Reciprosawing P.91**



**Grinding/Sanding/Polishing**

<p><b>Angle Grinder</b></p>    	<p><b>Bonded Abrasive P.111</b></p> <p>Grinding wheel  Flexible grinding wheel </p> <p>Cut-off wheel  Thin Cut-off wheel </p>
	<p><b>Coated Abrasive P.122</b></p> <p>Flap Disc  Fiber sanding disc </p>
	<p><b>Brushing P.104</b></p> <p>Wire brush  </p>
	<p><b>Diamond P.144</b></p> <p>Diamond wheels </p>
<p><b>Die Grinder</b></p> 	<p><b>Bonded Abrasive P.111</b></p> <p>Wheel point  Tungsten carbide burrs </p>
	<p><b>Coated Abrasive P.122</b></p> <p>Fiber sanding disc </p>
	<p><b>Abrasive belt</b></p> 
	<p><b>Abrasive paper</b></p> 
<p><b>Disc Sander</b></p> 	<p><b>Coated Abrasive P.122</b></p> <p>Fiber sanding disc </p>
	<p><b>Abrasive belt</b></p> 
<p><b>Belt Sander</b></p> 	<p><b>Abrasive belt</b></p> 
<p><b>Finishing Sander</b></p> 	<p><b>Abrasive paper</b></p> 
<p><b>Random Orbit Sander</b></p> 	<p><b>Abrasive disc</b></p> 
<p><b>Polisher</b></p> 	<p><b>Brushing P.104</b></p> <p>Wool bonnet  Wool pad </p> <p>Sponge pad </p>
	<p><b>100mm Diamond polishing pad</b></p> 
<p><b>Stone Polisher</b></p> 	<p><b>100mm Diamond polishing pad</b></p> 
<p><b>Wheel Sander</b></p> 	<p><b>Brushing P.104</b></p> <p>Wheel </p>
<p><b>Bench Grinder Straight Grinder</b></p> 	<p><b>Bonded Abrasive P.111</b></p> <p>Grinding wheel </p>







**Multifunction**

<p><b>Multi Tool</b></p> 	<p><b>Multi Tool P.133</b></p> <p>Multi Tool Accessories </p>
---	--



**Sawing**

<p><b>Slide Compound Miter Saw Circular Saw Table Saw</b></p> 	<p><b>Cutting P.76</b></p> <p>Saw blade </p>
<p><b>Jig saw</b></p> 	<p><b>Jigsaw / Reciprosawing P.91</b></p> <p>Jig saw blade </p>
<p><b>Reciprosaw</b></p> 	<p>Reciprosaw blade </p>
<p><b>Band saw</b></p> 	<p>Band saw blade </p>





**Milling/Planing**

<p><b>Planer</b></p> 	<p><b>Planing / Routering P.159</b></p> <p>Planer blade  Mini planer blade </p>
<p><b>Trimmer Router</b></p> 	<p>Router bit </p>
<p><b>Concrete Planer</b></p> 	<p><b>Diamond P.144</b></p> <p>Offset diamond wheel </p>

**Outdoor Power Equipment**

	<p><b>P.170</b></p> <p>Brushcutter blades  Chain blade </p> <p>Shear blade  Nozzle </p> <p>Nylon cutting head </p>
--	---

**Miscellaneous**

	<p><b>Hand Tool , Pouches &amp; Holders P.187</b></p> 
	<p><b>Pneumatic Tool P.187</b></p> <p>Nails  Staple </p>



Impact  
**PREMIER**

## What is Ideal for DC tool Accessories ?

Provides the greatest performance on DC tools!  
Higher speed, more work amount on a single full battery charge and a nice sense of use.\* Here are the parties which give you the greatest performance on your MAKITA DC tools. You can find recommended accessories for DC tools with DC tool icons with an emphasized battery symbol. Try and see MAKITA's leading-edge technology.

\*Features may vary by item.





## TCT saw blade EFFICUT series

### EFFICUT



Efficient Sharp Tip's Top Angle



Efficient Curved Tip's Body



Efficient Slimmed Bottom



The amount of cutting per 1 charge



100

140% UP



240

### EFFICUT Composite decking

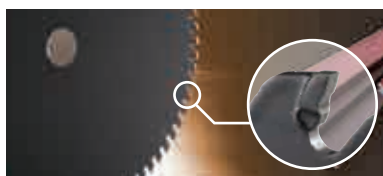

Efficient Curved Tip's Body



Efficient Slimmed Bottom



The amount of cutting per 1 charge

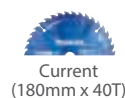

100

30% UP



130

### EFFICUT Metal



Strong and least chipping



Release swarf smoothly



Superior in straight cutting

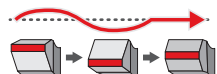

The amount of cutting per 1 charge



100

60% UP



160

### EFFICUT Aluminum



Strong and least chipping



Reduce cutting resistance



Superior in straight cutting

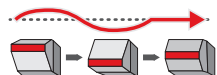

Release swarf smoothly



The amount of cutting per 1 charge



100

40% UP



140



### Diamond wheel for concrete

Specialized for 9inch DC Power Cutter

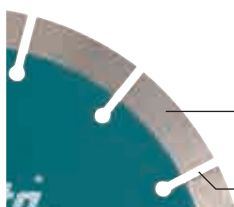

To reduce the cutting load, diamond grain size is designed small.

The narrower slits reduce dragging work pieces.



The amount of cutting per 1 charge



100

65% UP



165



### Cut-off wheel for Power cutter/ Metal / Ideal for Cordless Power cutter

Specialized for 14inch DC Power Cutter



Ideal blend of abrasive grain and bond for Cordless power cutter.

The amount of cutting per 1 charge



100

10% UP



110

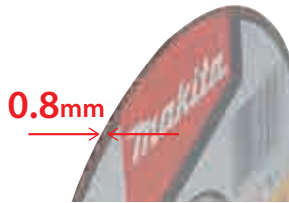

### Thin cut-off wheel

0.8mm thickness for fast cutting

#### Thinner thickness

0.8mm thinner thickness brings ... fast cutting / reduction of cutting resistance / less burr of materials / less dust of materials

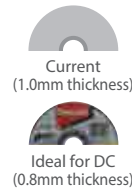

The amount of cutting per 1 charge

20% UP



### 2in1 grinding wheel

Cutting and deburring are possible in one disc

#### Specialized cutting work

Thanks to "SA"grid and 2.2mm thinner thickness, it enables you to cut fast and deburring safety.

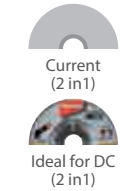

The amount of cutting per 1 charge

15% UP



### Flexible grinding wheel

Low vibration and no need back-up pad

#### Shock absorbed structure

Added shock absorbing material. You can feel overwhelmingly low vibration. Grinding speed is also faster because of its flexibility. It can touch materials more efficiency.

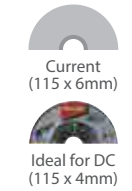

The amount of cutting per 1 charge

70% UP

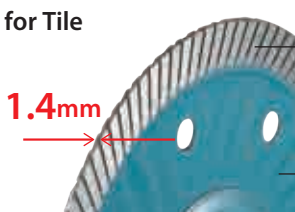

for Tile

### Thin diamond wheel

Smooth & light cutting

#### Thinner thickness & enough strength

1.4mm thickness able to get smooth and light cutting.

Corrugated Rim increases wheel tension and reduces vibration during the cut.



The amount of cutting per 1 charge

60% UP

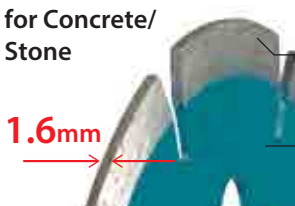

for Concrete/ Stone

#### Specialized cutting work

This blade is designed as 1.6mm. So smooth and light cutting is available.

It was lightened by punching the body. It is also reduce the load on the battery and increased the cutting distance per 1 battery charge.



The amount of cutting per 1 charge

50% UP

## XLOCK



### QUICK CHANGE

Minimizes downtime between accessory changes with no parts to lose



### TOOL-LESS SYSTEM

Easy click-mount and release level for tool-less accessory changes

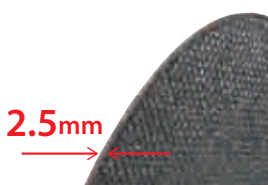

### Abrasive Cut-off wheel for metal stud

Specialized for 14inch DC Portable Cut-off

#### Thinner blade & the optimum bonding

2.5mm thickness blade for smooth and fast cutting. The optimum bonding for fast cutting and longer life.

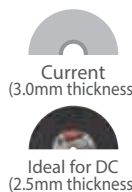

The amount of cutting per 1 charge

30% UP



# Impact PREMIER



**High Precision Screw Fitting.**



**New Steel is Used. Supports High Torque.**

**Double Torsion for High Durability.**

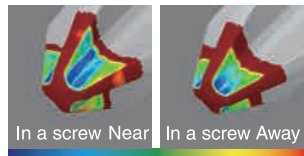

Impact PREMIER

STANDARD

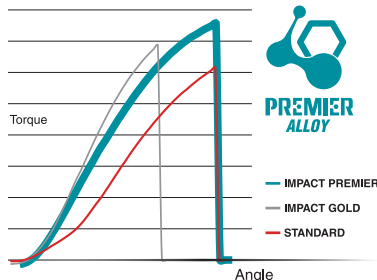

## Japanese teeth Reciprosaw Blade

0.6mm thickness Japanese teeth for fine cutting surface



### Japanese teeth

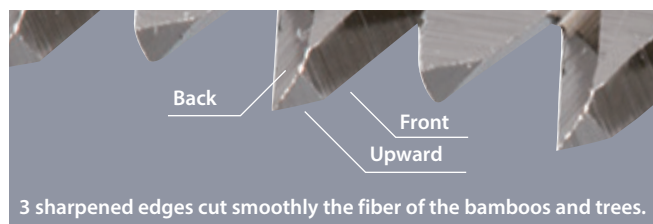

3 sharpened edges cut smoothly the fiber of the bamboos and trees.

For model: DJR185, DJR183, DJR145, JR100D, JR103D, JR105D



Perfect Finish!



Bad Finish...



## Four-leaf Nylon cord



Low noise and energy saving

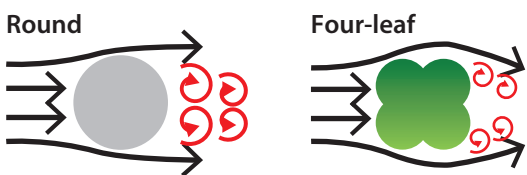

Four-leaf shape makes small vortex and realizes low noise and energy saving feature thanks to less air resistance.

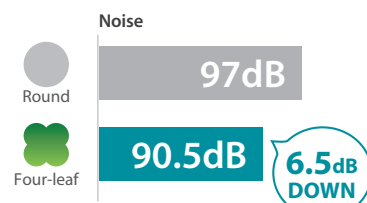
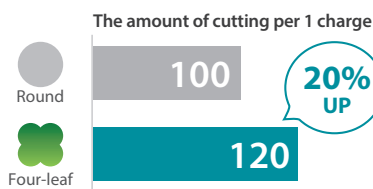

## 80 series saw chain **NEW**

1. Optimum cutter shape for smooth cutting

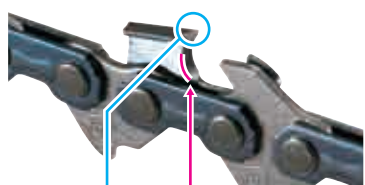

Sharp top angle    Deep-curved body

2. Short pitch for less vibration

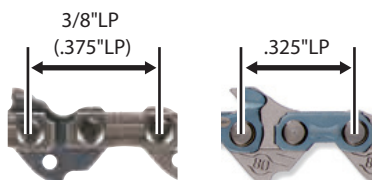

Current (90PX)

Ideal for DC (80series)

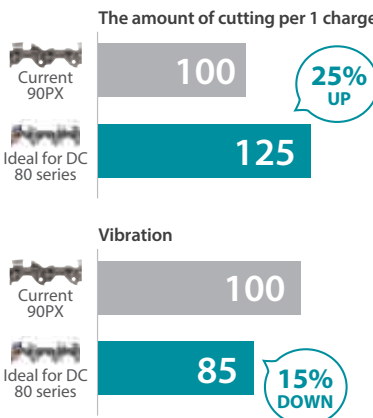

# ACCESSORIES

## ▣ Drilling (Wood/Metal)



Metal, mild steel



Stainless steel



Aluminium



Non-ferrous metal



Wood



Wood with nails



MDF



Plywood



Soft Tile



Brick



Limestone



Marble



Plastic



Fiberglass



Plaster board



High speed steel for metal drill



Tungsten carbide tip



Chisel edge



Split point



M-shape

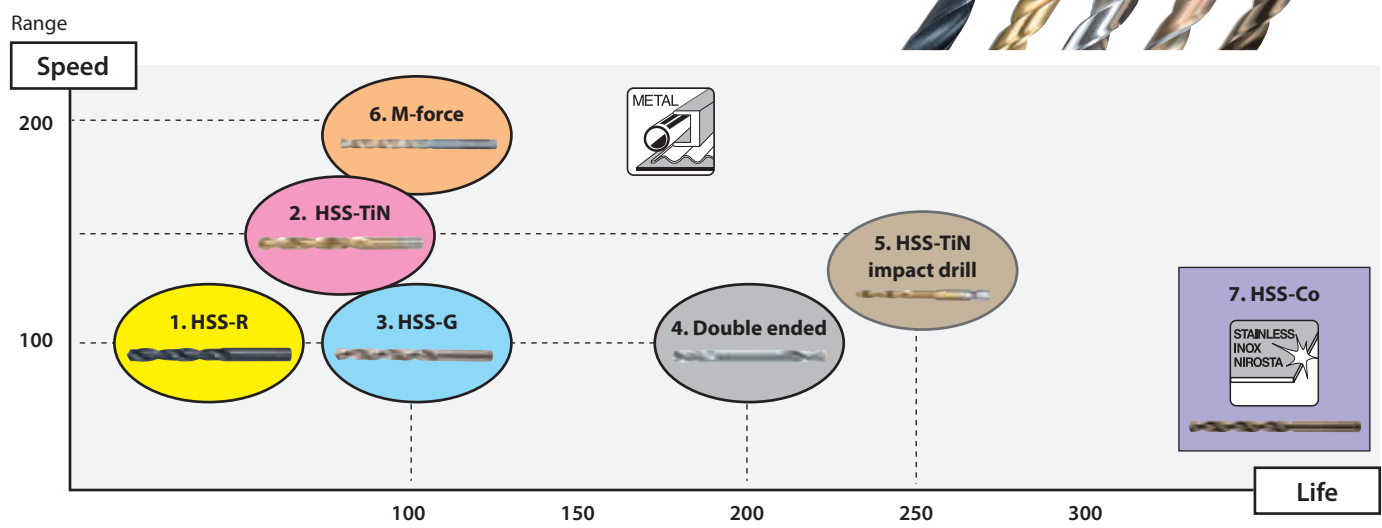
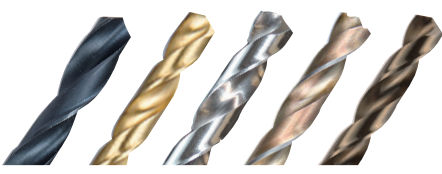





















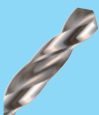







No.	1	2	3	4	5	6	7
Range	★	★★	★★★	★★★	★★★★	★★★★★	Specialized
Series							
Description	HSS-R 	HSS-TiN 	HSS-G 	Double ended 	HSS-TiN impact drill 	M-force 	HSS-Co5% 
Made of							
Process of manufacturing *	Roll forged 	Ground 					
Tip geometry **	Chisel edge 118° 	Split point 135° 	Chisel edge 118° 	Split point 135° 	M-shape 	Split point 135° 	
Surface	Black oxide finish  Anti-rust	TiN coating  Long life	Bright finish 		TiN coating  Long life	Amber finish  Anti-rust	
Shank	Straight (Cylindrical) 				1/4" Hex (E-form) 	Straight (Three flat)  Better grip than Cylindrical shank	Straight (Cylindrical) 

AA: Recommended      A: Acceptable

No.	1	2	3	4	5	6	7
Material	Wood	A	A	A	A	A	
	Plastic	AA	AA	AA	AA	AA	
	Non-ferrous metal***		AA	AA	AA	AA	A
	Sheet steel	A	AA	AA	AA	AA	A
	Cast iron	AA	AA	AA	AA	AA	AA
	Alloy steel		AA	AA	AA	AA	AA
	Stainless steel		A	A	A	A	A

\* Roll forged: Made by die-casted rolling machine. It is economical price.  
 Ground: Drill bits ground from the block with excellent surface quality.  
 \*\* 135°split point: Ensure no walking and start fast, on contact.  
 M-shape: Designed to focus on drilling smoothly and speedily.  
 \*\*\* Non-ferrous metal (Such as Copper, Nickel and Zinc)

# HSS metal drill bit line up

Series	Shank	Single pkg.	Set	Assortment
		1pc. / 2pcs.	5pcs. / 10pcs.	
 HSS-R	 Straight (Cylindrical)	Size: Metric  1pc. / 2pcs.	Size: Metric  5pcs. / 10pcs. set	Size: Metric  13pcs. set      19pcs. set      25pcs. set
 HSS-TiN	 Straight (Cylindrical)	Size: Metric / Inch  1pc. / 2pcs.	Size: Metric / Inch  5pcs. / 10pcs. set	Size: Metric / Inch  6pcs. set / -    10pcs. set / -    13pcs. set / 13pcs. set    19pc. sets / 21pcs. set    25pcs. set / 29pcs. set    19pcs. set / 18pcs. set
 HSS-G	 Straight (Cylindrical)	Size: Metric / Inch  Metric : 1pc. Inch : 1pc. / 2pcs.	Size: Metric / Inch  5pcs. / 10pcs. set	Size: Metric  19pcs. set    25pcs. set    13pcs. set    19pcs. set    25pcs. set
 HSS-TiN	 1/4" Hex (E-form)	Size: Metric / Inch  1pc.		Size: Inch  5pcs. set
 M-force	 Straight (Three flat)	Size: Metric  1pc.		Size: Metric  19pcs. set    25pcs. set
 HSS-Co	 Straight (Cylindrical)	Size: Metric / Inch  Metric : 1pc. Inch : 1pc. / 2pcs.	Size: Metric / Inch  5pcs. set	Size: Metric / Inch  19pcs. set / 21pcs. set    25pcs. set / -



**Metal drill bit HSS-R**



Diameter mm	Length mm	Working Length mm	Range	Sales Pkg Qty	Part No.
1	34	12	★	2	D-38283
1	34	12	★	10	D-38532
1.5	40	18	★	2	D-38299
1.5	40	18	★	10	D-38548
2	49	24	★	2	D-38308
2	49	24	★	10	D-38554
2.5	57	30	★	2	D-38314
2.5	57	30	★	10	D-38560
2.6	57	30	★	2	D-38 320
2.9	61	33	★	2	D-46931
2.9	61	33	★	10	D-46872
3	61	33	★	2	D-38336
3	61	33	★	10	D-38576
3.2	65	36	★	2	D-38342
3.2	65	36	★	10	D-38582
3.3	65	36	★	2	D-46713
3.3	65	36	★	10	D-46698
3.5	70	39	★	2	D-38358
3.5	70	39	★	10	D-38598
4	75	43	★	2	D-38364
4	75	43	★	10	D-38607
4.2	75	43	★	1	D-38370
4.2	75	43	★	10	D-38613
4.5	80	47	★	1	D-38386
4.5	80	47	★	10	D-38629
4.8	86	52	★	1	D-38392
4.8	86	52	★	10	D-38635
5	86	52	★	1	D-38401
5	86	52	★	10	D-38641
5.2	86	52	★	1	D-46729
5.2	86	52	★	10	D-46707
5.3	86	52	★	1	D-46947
5.3	86	52	★	10	D-46888
5.5	93	57	★	1	D-38417
5.5	93	57	★	10	D-38657
6	93	57	★	1	D-38423
6	93	57	★	10	D-38663
6.5	101	63	★	1	D-38439
6.5	101	63	★	10	D-38679
6.8	109	69	★	1	D-46953
6.8	109	69	★	10	D-46894
7	109	69	★	1	D-38445
7	109	69	★	10	D-38685
7.5	109	69	★	1	D-38451
7.5	109	69	★	10	D-38691
8	117	75	★	1	D-38467
8	117	75	★	10	D-38700
8.5	117	75	★	1	D-38473
8.5	117	75	★	10	D-38716
8.8	125	81	★	1	D-46969
8.8	125	81	★	10	D-46903
9	125	81	★	1	D-38489
9	125	81	★	10	D-38722
9.5	125	81	★	10	D-38738
10	133	87	★	1	D-38495
10	133	87	★	10	D-38744
10.3	133	87	★	1	D-46975
10.3	133	87	★	5	D-46919
10.5	133	87	★	5	D-38750
10.8	142	94	★	1	D-46981
10.8	142	94	★	5	D-46925
11	142	94	★	1	D-38504
11	142	94	★	5	D-38766
11.5	142	94	★	5	D-38772
12	151	101	★	1	D-38510
12	151	101	★	5	D-38788
12.5	151	101	★	5	D-38794
13	151	101	★	1	D-38526
13	151	101	★	5	D-38803

**Metal drill bit HSS-R assortment set in metal case**



Diameter mm	Range	Sales Pkg Qty	Part No.
1.5 to 6.5	★	13	D-54075
1 to 10	★	19	D-54081
1 to 13	★	25	D-54097

**Metal drill bit HSS-TiN**



Diameter mm	Length mm	Working Length mm	Range	Sales Pkg Qty	Part No.
1	34	12	★★	2	D-64004
1	34	12	★★	10	D-64250
1.5	40	18	★★	2	D-64010
1.5	40	18	★★	10	D-64266
2	49	24	★★	2	D-64026
2	49	24	★★	10	D-64272
2.5	57	30	★★	2	D-64032
2.5	57	30	★★	10	D-64288
3	61	33	★★	2	D-64048
3	61	33	★★	10	D-64294
3.5	70	39	★★	2	D-64054
3.5	70	39	★★	10	D-64303
4	75	43	★★	2	D-64060
4	75	43	★★	10	D-64319
4.5	80	47	★★	1	D-64076
4.5	80	47	★★	10	D-64325
5	86	52	★★	1	D-64082
5	86	52	★★	10	D-64331
5.5	93	57	★★	1	D-64098
5.5	93	57	★★	10	D-64347
6	93	57	★★	1	D-64107
6	93	57	★★	10	D-64353
6.5	101	63	★★	1	D-64113
6.5	101	63	★★	10	D-64369
7	109	69	★★	1	D-64129
7	109	69	★★	10	D-64375
7.5	109	69	★★	1	D-64135
7.5	109	69	★★	10	D-64381
8	117	75	★★	1	D-64141
8	117	75	★★	10	D-64397
8.5	117	75	★★	1	D-64157
8.5	117	75	★★	5	D-64406
9	125	81	★★	1	D-64163
9	125	81	★★	5	D-64412
9.5	125	81	★★	1	D-64179
9.5	125	81	★★	5	D-64428
10	133	87	★★	1	D-64185
10	133	87	★★	5	D-64434
10.5	133	87	★★	1	D-64191
10.5	133	87	★★	5	D-64440
11	142	94	★★	1	D-64200
11	142	94	★★	5	D-64456
11.5	142	94	★★	1	D-64216
11.5	142	94	★★	5	D-64462
12	151	101	★★	1	D-64222
12	151	101	★★	5	D-64478
12.5	151	101	★★	1	D-64238
12.5	151	101	★★	5	D-64484
13	151	101	★★	1	D-64244
13	151	101	★★	5	D-64490
14	160	108	★★	1	D-65741
15	169	114	★★	1	D-65757
16	178	120	★★	1	D-65763
17	184	125	★★	1	D-65779
18	191	130	★★	1	D-65785
19	198	135	★★	1	D-65791
20	205	140	★★	1	D-65800

**Metal drill bit HSS-TiN assortment set in plastic case**



Diameter mm	Range	Sales Pkg Qty	Part No.
2 to 8	★★	6	D-72833
1 to 10	★★	10	D-72849
1.5 to 6.5	★★	13	D-72855
1 to 10	★★★★	19	B-67795
1 to 10	★★	19	D-67527
1 to 10	★★	19x10sets	D-72229-10
1 to 13	★★	25x6sets	D-72235-6

**Metal drill bit HSS-TiN coated flute assortment set in metal case**



Diameter mm	Range	Sales Pkg Qty	Part No.
1 to 10	★★★★	170	D-30564

**Metal drill bit HSS-TiN with 1/4inch Hex shank**



Diameter mm	Length mm	Working Length mm	Shank Type	Range	Sales Pkg Qty	Part No.
2.5	78	30	1/4inch Hex MZ	★★★★	1	D-46517
3	81	33		★★★★	1	D-14928
3.2	85	36		★★★★	1	D-14934
3.3	85	36		★★★★	1	D-16081
4	95	43		★★★★	1	D-14940
4.1	95	43		★★★★	1	D-16483
4.2	95	43		★★★★	1	D-14956
5	106	52		★★★★	1	D-14962
5.2	102	52		★★★★	1	D-46523
6	113	57		★★★★	1	D-14978
6.5	121	63		★★★★	1	D-17778
8	117	75		★★★★	1	D-15827
10	133	87		★★★★	1	D-15833
12	151	101	★★★★	1	D-15849	
13	151	101	★★★★	1	D-15855	
2.5	78	30	1/4inch Hex NZ	★★★★	1	D-46539
3	91	33		★★★★	1	D-31114
3.2	95	36		★★★★	1	D-31120
3.3	95	36		★★★★	1	D-31136
4	105	43		★★★★	1	D-31142
4.1	105	43		★★★★	1	D-31158
4.2	105	43		★★★★	1	D-31164
5	116	52		★★★★	1	D-31170
5.2	102	52		★★★★	1	D-46545
6	123	57		★★★★	1	D-31186
6.5	131	63		★★★★	1	D-31192
8	117	75		★★★★	1	D-31201
10	133	87		★★★★	1	D-31217
12	151	101	★★★★	1	D-31223	
13	151	101	★★★★	1	D-31239	

**Metal impact drill bit HSS-TiN with 1/4inch Hex shank**



Diameter mm	Length mm	Working Length mm	Shank Type	Range	Sales Pkg Qty	Part No.
3	64	26	1/4inch Hex MZ	★★★★	1	B-50887
3.2	67	29		★★★★	1	B-50893
3.3	70	29		★★★★	1	B-50902
3.5	70	29		★★★★	1	B-50918
4	71	30		★★★★	1	B-50924
4.2	71	31		★★★★	1	B-50930
4.5	75	31		★★★★	1	B-50946
5	78	33		★★★★	1	B-50952
5.5	78	35		★★★★	1	B-50968
6	80	37		★★★★	1	B-50974
6.5	81	38		★★★★	1	B-50980
7	89	45		★★★★	1	B-50996
7.5	95	50		★★★★	1	B-51007
8	102	50	★★★★	1	B-51013	
8.5	102	50	★★★★	1	B-51029	
9	102	50	★★★★	1	B-51035	
10	102	50	★★★★	1	B-51041	
11	102	50	★★★★	1	B-51057	
12	102	50	★★★★	1	B-51063	
13	102	50	★★★★	1	B-51079	
3	64	26	1/4inch Hex NZ	★★★★	1	B-51085
3.2	67	29		★★★★	1	B-51091
3.3	70	29		★★★★	1	B-51100
3.5	70	29		★★★★	1	B-51116
4	71	30		★★★★	1	B-51122
4.2	71	31		★★★★	1	B-51138
4.5	75	31		★★★★	1	B-51144
5	78	33		★★★★	1	B-51150
5.5	78	35		★★★★	1	B-51166
6	80	37		★★★★	1	B-51172
6.5	81	38		★★★★	1	B-51188
7	89	45		★★★★	1	B-51194
7.5	95	50		★★★★	1	B-51203
8	102	50	★★★★	1	B-51219	
8.5	102	50	★★★★	1	B-51225	
9	102	50	★★★★	1	B-51231	
10	102	50	★★★★	1	B-51247	
11	102	50	★★★★	1	B-51253	
12	102	50	★★★★	1	B-51269	
13	102	50	★★★★	1	B-51275	

**Metal impact drill bit HSS-TiN with 1/4inch Hex shank assortment set**



Diameter mm	Shank Type	Range	Sales Pkg Qty	Part No.
3, 4, 5, 6, 8	1/4inch Hex MZ	★★★★	5	B-57308

**Metal drill bit HSS-TiN for SDS-PLUS Hammers**



Diameter mm	Length mm	Working Length mm	Shank Type	Range	Sales Pkg Qty	Part No.
3	90	33	SDS-PLUS	★★★★	1	B-57401
3.5	100	39		★★★★	1	B-57417
4	105	43		★★★★	1	B-57423
4.5	110	47		★★★★	1	B-57439

Diameter mm	Length mm	Working Length mm	Shank Type	Range	Sales Pkg Qty	Part No.
5	116	52	SDS-PLUS	★★★★	1	B-57445
5.5	123	57		★★★★	1	B-57451
6	123	57		★★★★	1	B-57467
6.5	131	63		★★★★	1	B-57473

**Metal drill bit HSS-G**



Diameter mm	Length mm	Working Length mm	Range	Sales Pkg Qty	Part No.
1.5	40	18	★★★	1	D-09656
1.5	40	18	★★★★	10	D-06236
1.75	46	22	★★★	10	D-06242
2	49	24	★★★	1	D-09662
2	49	24	★★★	10	D-06258
2.25	53	27	★★★	10	D-06264
2.5	57	30	★★★	1	D-09678
2.5	57	30	★★★	10	D-06270
2.75	61	33	★★★	10	D-06286
2.9	61	33	★★★	1	D-46816
2.9	61	33	★★★	10	D-46648
3	61	33	★★★	1	D-09684
3	61	33	★★★	10	D-06292
3.2	65	36	★★★	1	D-46589
3.2	65	36	★★★	10	D-34942
3.25	65	36	★★★	10	D-06301
3.3	65	36	★★★	1	D-46595
3.3	65	36	★★★	10	D-46567
3.5	70	39	★★★	1	D-09690
3.5	70	39	★★★	10	D-06317
3.75	70	39	★★★	10	D-06323
4	75	43	★★★	1	D-09709
4	75	43	★★★	10	D-06339
4.2	75	43	★★★	1	D-46604
4.2	75	43	★★★	10	D-17762
4.25	75	43	★★★	10	D-06345
4.5	80	47	★★★	1	D-09715
4.5	80	47	★★★	10	D-06351
4.75	80	47	★★★	10	D-06367
5	86	52	★★★	1	D-09721
5	86	52	★★★	10	D-06373
5.2	86	52	★★★	1	D-46610
5.2	86	52	★★★	10	D-34986
5.25	86	52	★★★	10	D-06389
5.3	86	52	★★★	1	D-46822
5.3	86	52	★★★	10	D-46654
5.5	93	57	★★★	1	D-09737
5.5	93	57	★★★	10	D-06395
5.75	93	57	★★★	10	D-06404
6	93	57	★★★	1	D-09743
6	93	57	★★★	10	D-06410
6.25	101	63	★★★	10	D-06426
6.5	101	63	★★★	1	D-09759
6.5	101	63	★★★	10	D-06432
6.75	109	69	★★★	10	D-06448
6.8	109	69	★★★	1	D-46838
6.8	109	69	★★★	10	D-46779
7	109	69	★★★	1	D-09765
7	109	69	★★★	10	D-06454
7.25	109	69	★★★	10	D-06460
7.5	109	69	★★★	1	D-09771
7.5	109	69	★★★	10	D-06476
7.75	117	75	★★★	10	D-06482
8	117	75	★★★	1	D-09787
8	117	75	★★★	10	D-06498
8.25	117	75	★★★	5	D-06507
8.5	117	75	★★★	1	D-09793
8.5	117	75	★★★	5	D-06513
8.75	125	81	★★★	5	D-06529
8.8	125	81	★★★	1	D-46844
8.8	125	81	★★★	5	D-46785
9	125	81	★★★	1	D-09802
9	125	81	★★★	5	D-06535
9.25	125	81	★★★	5	D-06541
9.5	125	81	★★★	1	D-09818

Diameter mm	Length mm	Working Length mm	Range	Sales Pkg Qty	Part No.
9.5	125	81	★★★	5	D-06557
9.75	133	87	★★★	5	D-06563
10	133	87	★★★	1	D-09824
10	133	87	★★★	5	D-06579
10.25	133	87	★★★	5	D-06585
10.3	133	87	★★★	1	D-46850
10.3	133	87	★★★	5	D-46791
10.5	133	87	★★★	1	D-09830
10.5	133	87	★★★	5	D-06591
10.8	142	94	★★★	1	D-46866
10.8	142	94	★★★	5	D-46800
11	142	94	★★★	1	D-09846
11	142	94	★★★	5	D-06600
11.5	142	94	★★★	1	D-09852
11.5	142	94	★★★	5	D-06616
12	151	101	★★★	1	D-09868
12	151	101	★★★	5	D-06622
12.5	151	101	★★★	1	D-09874
12.5	151	101	★★★	5	D-06638
13	151	101	★★★	1	D-09880
13	151	101	★★★	5	D-06644

**Metal drill bit HSS-G assortment set in plastic case**



Diameter mm	Range	Sales Pkg Qty	Part No.
1 to 10	★★★	19	D-67549
1 to 13	★★★	25	D-67555

**Metal drill bit HSS-G assortment set in metal case**



Diameter mm	Range	Sales Pkg Qty	Part No.
1.5 to 6.5	★★★	13	D-54019
1 to 10	★★★	19	D-54025
1 to 13	★★★	25	D-54031

**Metal drill bit HSS M-Force**



Diameter mm	Length mm	Working Length mm	Range	Sales Pkg Qty	Part No.
2	49	24	★★★★	1	D-29614
2.5	57	30	★★★★	1	D-29620
3	61	33	★★★★	1	D-29636
3.2	65	36	★★★★	1	D-37633
3.3	65	36	★★★★	1	D-46626
3.5	70	39	★★★★	1	D-29642
4	75	43	★★★★	1	D-29658
4.2	75	43	★★★★	1	D-37649
4.5	80	47	★★★★	1	D-29664
5	86	52	★★★★	1	D-29670
5.2	86	52	★★★★	1	D-37655
5.5	93	57	★★★★	1	D-29686
6	93	57	★★★★	1	D-29692
6.5	101	63	★★★★	1	D-29701
7	109	69	★★★★	1	D-29717
7.5	109	69	★★★★	1	D-29723
8	117	75	★★★★	1	D-29739
8.5	117	75	★★★★	1	D-29745

Diameter mm	Length mm	Working Length mm	Range	Sales Pkg Qty	Part No.
9	125	81	★★★★	1	D-29751
9.5	125	81	★★★★	1	D-29767
10	133	87	★★★★	1	D-29773
10.5	133	87	★★★★	1	D-29789
11	142	94	★★★★	1	D-29795
11.5	142	94	★★★★	1	D-29804
12	151	101	★★★★	1	D-29810
12.5	151	101	★★★★	1	D-29826
13	151	101	★★★★	1	D-29832

**Metal drill bit HSS M-Force assortment set in plastic case**



Diameter mm	Range	Sales Pkg Qty	Part No.
1 to 10	★★★★	19	D-67583
1 to 13	★★★★	25	D-67599

**Metal drill bit HSS-Co cobalt 5%**



Diameter mm	Length mm	Working Length mm	Range	Sales Pkg Qty	Part No.
1.5	40	18	Specialized	1	D-17289
1.5	40	18	Specialized	5	D-16617
1.75	46	22	Specialized	5	D-17625
2	49	24	Specialized	1	D-17295
2	49	24	Specialized	5	D-16623
2.5	57	30	Specialized	1	D-17304
2.5	57	30	Specialized	5	D-16639
3	61	33	Specialized	1	D-17310
3	61	33	Specialized	5	D-16645
3.2	65	36	Specialized	1	D-17326
3.2	65	36	Specialized	5	D-16651
3.3	65	36	Specialized	1	D-46660
3.3	65	36	Specialized	5	D-46632
3.5	70	39	Specialized	1	D-17332
3.5	70	39	Specialized	5	D-16667
4	75	43	Specialized	1	D-17348
4	75	43	Specialized	5	D-16673
4.2	75	43	Specialized	1	D-46676
4.2	75	43	Specialized	5	D-34958
4.5	80	47	Specialized	1	D-17354
4.5	80	47	Specialized	5	D-16689
5	86	52	Specialized	1	D-17360
5	86	52	Specialized	5	D-16695
5.2	86	52	Specialized	1	D-46682
5.2	86	52	Specialized	5	D-34992
5.5	93	57	Specialized	1	D-17376
5.5	93	57	Specialized	5	D-16704
6	93	57	Specialized	1	D-17382
6	93	57	Specialized	5	D-16710
6.5	101	63	Specialized	1	D-17398
6.5	101	63	Specialized	5	D-16726
7	109	69	Specialized	1	D-17407
7	109	69	Specialized	5	D-16732
7.5	109	69	Specialized	1	D-17413
7.5	109	69	Specialized	5	D-16748
8	117	75	Specialized	1	D-17429
8	117	75	Specialized	5	D-16754
8.5	117	75	Specialized	1	D-17435
8.5	117	75	Specialized	5	D-16760
9	125	81	Specialized	1	D-17441
9	125	81	Specialized	5	D-16776
9.5	125	81	Specialized	1	D-17457
9.5	125	81	Specialized	5	D-16782
10	133	87	Specialized	1	D-17463

Diameter mm	Length mm	Working Length mm	Range	Sales Pkg Qty	Part No.
10	133	87	Specialized	5	D-16798
10.5	133	87	Specialized	1	D-17479
10.5	133	87	Specialized	5	D-16807
11	142	94	Specialized	1	D-17485
11	142	94	Specialized	5	D-16813
11.5	142	94	Specialized	1	D-17491
11.5	142	94	Specialized	5	D-16829
12	151	101	Specialized	1	D-17500
12	151	101	Specialized	5	D-16835
12.5	151	101	Specialized	1	D-17516
12.5	151	101	Specialized	5	D-16841
13	151	101	Specialized	1	D-17522
13	151	101	Specialized	5	D-16857

**Metal drill bit HSS-Co cobalt 5% assortment set in plastic case**



Diameter mm	Range	Sales Pkg Qty	Part No.
1 to 10	Specialized	19	D-67561
1 to 13	Specialized	25	D-67577

**Metal rivet drill bit with 1/4inch Hex shank**



Diameter mm	Length mm	Working Length mm	Shank Type	Range	Sales Pkg Qty	Part No.
3.3	50	20	1/4inch Hex MZ	★★★	10	B-56437

**Metal double ended drill bit**



Diameter mm	Length mm	Working Length mm	Range	Sales Pkg Qty	Part No.
2	38	7.5	★★★	10	B-26652
2.5	43	10	★★★★	10	B-33772
3	46	10.6	★★★★	10	B-26668
3.1	49	11	★★★★	10	B-26674
3.2	49	11	★★★★	10	B-26680
3.3	49	11	★★★★	10	B-26696
3.5	52	13	★★★★	10	B-26705
3.8	55	14	★★★★	10	B-26711
4	55	14	★★★★	10	B-26727
4.1	55	14	★★★★	10	B-26733
4.2	55	14	★★★★	10	B-26749
4.3	55	14	★★★★	10	B-26755
4.5	58	16	★★★★	10	B-26761
4.8	62	17	★★★★	10	B-26777
4.9	62	17	★★★★	10	B-26783
5	62	17	★★★★	10	B-26799
5.1	62	17	★★★★	10	B-26808
5.2	62	17	★★★★	10	B-26814
5.5	66	19	★★★★	10	B-26820
6	66	19	★★★★	10	B-26836
6.5	70	21	★★★★	10	B-33788
8	79	25	★★★★	10	B-26842
10	89	25	★★★★	10	B-26858

# Step drill bit

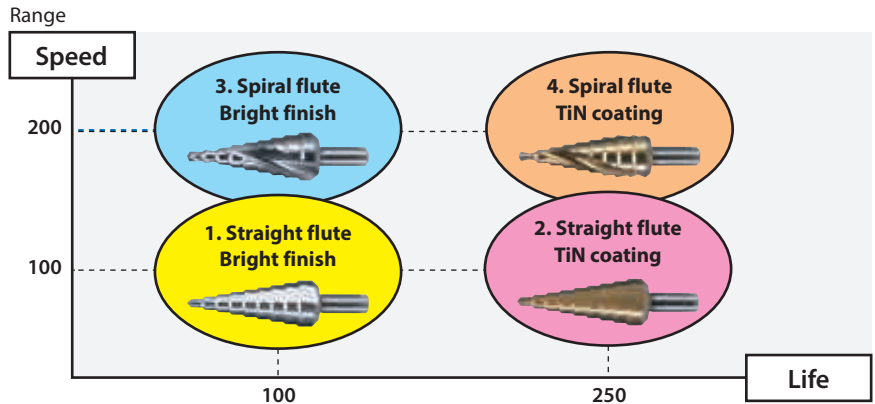
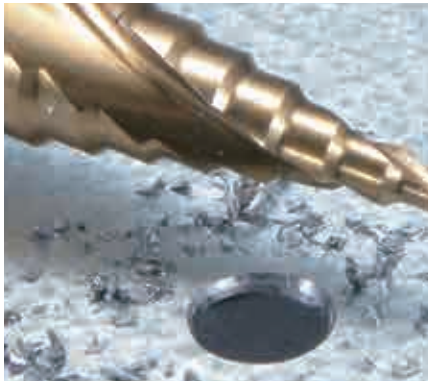

**Material chart** AA: Recommended A: Acceptable

Description	Flute	Surface	Shank	Material				
				Plastic	Non-ferrous metal*	Sheet steel	Alloy steel	Cast iron
<b>1</b>		Bright finish	Straight (Three flat)	AA	AA	AA	A	A
<b>2</b>		Titanium coating		AA	AA	AA	A	A
<b>3</b>		Bright finish	1/4"Hex (E form)	AA	AA	AA	A	A
<b>4</b>		Titanium coating		AA	AA	AA	A	A

\*Non-ferrous metal (Such as Copper, Nickel and Zinc)

# Countersink bit



**Material chart** AA: Recommended A: Acceptable

Description	Made of	Type	Shank	Material					
				Wood	Plastic	Non-ferrous metal*	Cast iron	Alloy steel	Stainless steel
	Alloy steel		1/4"Hex (E form)	AA	AA	AA	AA		
	High speed steel	Shallow sinking Suitable for flat countersinking.	Straight shank (Three flat)	AA	AA	AA	AA	AA	
		Deep sinking Suitable for deep countersinking.	1/4"Hex (C-form)	AA	AA	AA	AA	AA	
	High speed steel (Cobalt content 5%)	Shallow sinking Suitable for flat countersinking. Especially in thin metal sheets.	Straight shank (Three flat)		AA	AA	AA	AA	A
 It's for higher heat and abrasion resistance. Suitable for drilling tough metal.				Straight shank (Three flat)		AA	AA	AA	AA

\*Non-ferrous metal (Such as Copper, Nickel and Zinc)

**Metal cone drill bit**



Diameter mm	Length mm	Shank Type	Range	Sales Pkg Qty	Part No.
3 to 14	58	Straight	★★★	1	D-40048
4 to 20	71		★★★	1	D-40054
16 to 30.5	76		★★★	1	D-40060
24 to 40	89		★★★	1	D-40076

**Metal step drill bit straight flute**



Diameter mm	Length mm	Shank Type	Range	Sales Pkg Qty	Part No.
4 to 32	102	Straight	★★★	1	D-40107

**Metal step drill bit straight flute titanium coating**



Diameter mm	Length mm	Shank Type	Range	Sales Pkg Qty	Part No.
4 to 32	102	Straight	★★★★	1	D-40135

**Metal step drill bit with 1/4inch Hex shank straight flute**



Diameter mm	Length mm	Shank Type	Range	Sales Pkg Qty	Part No.
4 to 12	65	1/4inch	★★★★	1	D-40082
4 to 20	75	Hex MZ	★★★★	1	D-40098
4 to 12	65	1/4inch	★★★★	1	D-46414
4 to 20	75	Hex NZ	★★★★	1	D-46420

**Metal step drill bit with 1/4inch Hex shank straight flute titanium coating**



Diameter mm	Length mm	Shank Type	Range	Sales Pkg Qty	Part No.
4 to 12	65	1/4inch	★★★★	1	D-40113
4 to 20	75	Hex MZ	★★★★	1	D-40129
4 to 12	65	1/4inch	★★★★	1	D-46436
4 to 20	75	Hex NZ	★★★★	1	D-46442

**Metal step drill bit straight flute titanium coating assortment set in plastic case**



Diameter mm	Length mm	Shank Type	Range	Sales Pkg Qty	Part No.
4 to 12, 4 to 20, 4 to 32	65-102	1/4inch Hex MZ, Straight	★★★★	3	D-46573

**Metal step drill bit spiral flute**



Diameter mm	Length mm	Shank Type	Range	Sales Pkg Qty	Part No.
4 to 32	102	Straight	★★★★	1	D-40163

**Metal step drill bit spiral flute titanium coating**



Diameter mm	Length mm	Shank Type	Range	Sales Pkg Qty	Part No.
4 to 32	102	Straight	★★★★	1	D-40191

**Metal step drill bit with 1/4inch Hex shank spiral flute**



Diameter mm	Length mm	Shank Type	Range	Sales Pkg Qty	Part No.
4 to 12	65	1/4inch	★★★★	1	D-40141
4 to 20	75	Hex MZ	★★★★	1	D-40157
4 to 12	65	1/4inch	★★★★	1	D-46458
4 to 20	75	Hex NZ	★★★★	1	D-46464

**Metal step drill bit with 1/4inch Hex shank spiral flute titanium coating**



Diameter mm	Length mm	Shank Type	Range	Sales Pkg Qty	Part No.
4 to 12	65	1/4inch	★★★★	1	D-40179
4 to 20	75	Hex MZ	★★★★	1	D-40185
4 to 12	65	1/4inch	★★★★	1	D-46470
4 to 20	75	Hex NZ	★★★★	1	D-46486

**Metal step drill bit spiral flute titanium coating assortment set in plastic case**

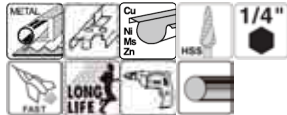

Diameter mm	Length mm	Shank Type	Range	Sales Pkg Qty	Part No.
4 to 12, 4 to 20, 4 to 32	65-102	1/4inch Hex MZ, Straight	★★★★	3	D-41872

**Metal countersink bit slanting hole**



Diameter mm	Length mm	Shank Type	Range	Sales Pkg Qty	Part No.
2 to 5	45	Straight	★★★★	1	D-37502
5 to 10	48		★★★★	1	D-37518
10 to 15	65		★★★★	1	D-37524
15 to 20	85		★★★★	1	D-37530

**Countersink bit three 90deg cutting edges**



Diameter mm	Length mm	Shank Type	Range	Sales Pkg Qty	Part No.
6.3	45	Straight	★★★	1	D-37437
8.3	50		★★★	1	D-37443
10.4	50		★★★	1	D-37459
12.4	56		★★★	1	D-37465
16.5	60		★★★	1	D-37471
20.5	63		★★★	1	D-37487
25	67		★★★	1	D-37493

**Countersink bit three 90deg cutting edges assortment set in metal case**



Diameter mm	Length mm	Shank Type	Range	Sales Pkg Qty	Part No.
6.3, 8.3, 10.4, 12.4, 16.5, 20.5	45, 50, 50, 56, 60, 63	Straight	★★★	6	D-42204

**Countersink bit with 1/4inch Hex shank three 90deg cutting edges**



Diameter mm	Length mm	Shank Type	Range	Sales Pkg Qty	Part No.
6.3	31	1/4inch Hex C-form	★★★	1	D-37312
8.3	31		★★★	1	D-37328
10.4	34		★★★	1	D-37334
12.4	35		★★★	1	D-37340
16.5	40		★★★	1	D-37356
20.5	41		★★★	1	D-37362

**Countersink bit five 90deg cutting edges**



Diameter mm	Length mm	Shank Type	Range	Sales Pkg Qty	Part No.
6	48	Straight	★★★	1	D-37378
8	48	Straight	★★★	1	D-37384
10	40	Straight	★★★	1	D-37390
12	40	Straight	★★★	1	D-37409
16	43	Straight	★★★	1	D-37415
20	45	Straight	★★★	1	D-37421

**Countersink bit seven 90deg cutting edges**



Diameter mm	Length mm	Shank Type	Range	Sales Pkg Qty	Part No.
13	50	Straight	★★	1	D-37306













**Wood countersink drill bit with 1/4inch Hex shank assortment set**



Diameter (inch)	Length (inch)	Shank Type	Range	Sales Pkg Qty	Part No.
(3/32-6#, 7/64-8#, 1/8-10#, 9/64-12#)	(2-1/4, 2-13/32, 2-9/16, 2-3/4)	1/4inch Hex MZ	★★	4	D-73455

## Wood drill bit series

AA : Recommended      A : Acceptable

Category		Flat bit	Wood drill bit				Single spur auger bit	Ship auger bit
Description		Suitable for drilling holes with medium to large diameters in soft wood or soft plastic.It's simple made and reasonable price.It's popular especially in America.	This is the most popular drill in wood drill and suitable for drilling holes with small to medium diameter.Able to drill soft plastics other than general wood.Highly effective for drilling cleaner and more precise holes than flat bit.				Suitable for drilling of deep holes with medium to large diameters holes in soft and hard wood.Threaded screw point pull the bit into the work piece providing a fast, easy to use self feeding action. Highly effective for drilling cleaner and more precise holes than flat bit or wood drill bit.	Suitable for knotty nail embedded wood which unable to drill with single spur auger bit. Suitable for plumbing and electrical installation, etc.
Information	Shank	Straight (Hex) 	Straight (Cylindrical) 	1/4"Hex (E-form) 	SDS-PLUS 	Straight (Hex) 	1/4"Hex (E-form) 	5/16" & 7/16"Hex 
	Diameter	6 - 36mm	3 - 20mm	2 - 15mm	4 - 10mm	6 - 30mm	6-21mm	10-38mm
	Point	Brad point 	Brad point 				Auger thread 	
Material	Wood 	AA	AA				AA	A
	Wood with nail 							AA
	Plywood 		A				A	A
Processing	Thickness 							
	Blind hole 		A					
Action photo								

# Wood drill bit series



AA : Recommended      A : Acceptable

Category		Formwork drill bit	Self feeding bit	Forstner drill bit	T.C.T. Hinge cutting bit	Adjustable circle cutter
Description		Rarely being clogged even drilling on plywood including adhesive because of chisel edge.Can be used on formboard or 2x4 timbers at once because of their long overall length (400 & 600mm)	Suitable for drilling large diameter holes for pipe and conduit in wood. Threaded screw point pull the bit into the work piece providing a fast, easy to use self feeding action. Suitable for plumbing and electrical installation, etc	Suitable for drilling of blind holes or penetrating holes of medium to large diameter with highly. Can drill cleaner and more precise holes than T.C.T. Hinge drill bit. Suitable for precise working like a making furniture.	Suitable for drilling of blind holes or penetrating holes of medium or large diameter.Suitable for drilling holes in fancy plywood because making-off blade and rake blade are made T.C.T. tip.	Adjustable drilling diameter and able to work on plaster board mainly. Suitable for plumbing and installation of the downlight.
Information	Shank	Straight (Cylindrical) 	7/16"Hex 	Straight (Cylindrical) 	Straight (Cylindrical) 	Straight (Three flat) 
	Diameter	8-30mm	25-117mm	10-50mm	15-35mm	30-200mm
	Point	Chisel edge 	Auger thread 	Brad point (Short) 	Brad point (Short) 	Chisel edge 
Material	Wood 	A	AA	AA	AA	A
	Wood with nail 	A				
	Plywood 	AA			A	A
Processing	Thickness 					
	Blind hole 			AA	AA	
Action photo						

### Wood brad point drill bit



Diameter mm	Length mm	Working Length mm	Range	Sales Pkg Qty	Part No.
3	61	33	★★★	1	D-07026
3	61	33	★★★	10	D-71722
4	75	43	★★★	1	D-07032
4	75	43	★★★	10	D-71738
5	86	52	★★★	1	D-07048
5	86	52	★★★	10	D-71744
6	93	57	★★★	1	D-07054
6	93	57	★★★	10	D-71750
6	315	150	★★★	1	D-07157
7	109	69	★★★	1	D-07060
8	117	75	★★★	1	D-07076
8	117	75	★★★	10	D-71766
8	315	150	★★★	1	D-07163
9	125	80	★★★	1	D-07082
10	133	87	★★★	1	D-07098
10	133	87	★★★	5	D-71772
10	315	150	★★★	1	D-07179
12	151	96	★★★	1	D-07107
12	315	150	★★★	1	D-07185
13	151	96	★★★	1	D-53453
14	160	100	★★★	1	D-07113
14	315	150	★★★	1	D-07191
15	160	100	★★★	1	D-53469
16	160	100	★★★	1	D-07129
16	315	150	★★★	1	D-07200
18	180	120	★★★	1	D-07135
18	335	150	★★★	1	D-07216
20	200	130	★★★	1	D-07141
20	335	150	★★★	1	D-07222

### Wood brad point drill bit assortment set in plastic case



Diameter mm	Range	Sales Pkg Qty	Part No.
4 to 10	★★★	5	D-72861

### Wood brad point drill bit with 1/4inch Hex shank



Diameter mm	Length mm	Working Length mm	Shank Type	Range	Sales Pkg Qty	Part No.
2	69	24	1/4inch Hex MZ	★★★	1	D-62387
3	78	33		★★★	1	D-15861
4	92	50		★★★	1	D-15877
5	103	57		★★★	1	D-15883
6	110	65		★★★	1	D-15899
8	117	75		★★★	1	D-15908
10	133	87		★★★	1	D-15914
12	151	96		★★★	1	D-15920
15	162	100		★★★	1	D-15936

Diameter mm	Length mm	Working Length mm	Shank Type	Range	Sales Pkg Qty	Part No.
3	80	33	1/4inch Hex NZ	★★★	1	D-31245
4	95	43		★★★	1	D-31251
5	105	52		★★★	1	D-31267
6	115	57		★★★	1	D-31273
8	117	75		★★★	1	D-31289
10	133	87		★★★	1	D-31295
12	151	96		★★★	1	D-31304
15	162	100		★★★	1	D-31310

### Wood brad point drill bit with 1/4inch Hex shank assortment set



Diameter mm	Length mm	Range	Sales Pkg Qty	Part No.
2, 3, 3, 4, 5, 6, 8	69, 75, 90, 100, 110, 115	★★★	7	D-62371

### Wood brad point drill bit for SDS-PLUS Hammers



Diameter mm	Length mm	Working Length mm	Shank Type	Range	Sales Pkg Qty	Part No.
4	105	43	SDS-PLUS	★★★	1	B-57489
5	116	52		★★★	1	B-57495
6	123	57		★★★	1	B-57504
8	147	75		★★★	1	B-57510
10	163	87		★★★	1	B-57526

### Wood flat bit



Diameter mm	Length mm	Range	Sales Pkg Qty	Part No.
6	150	★★	1	D-07674
8	150	★★	1	D-07680
10	150	★★	1	D-07696
12	150	★★	1	D-07705
13	150	★★	1	D-67614
14	150	★★	1	D-07711
15	150	★★	1	D-07727
16	150	★★	1	D-07733
18	150	★★	1	D-07749
20	150	★★	1	D-07755
22	150	★★	1	D-07761
24	150	★★	1	D-07777
25	150	★★	1	D-07783
26	160	★★	1	D-07799
28	160	★★	1	D-07808
30	160	★★	1	D-07814
32	160	★★	1	D-07820
34	160	★★	1	D-07836
35	160	★★	1	D-07842
36	160	★★	1	D-07858

**Wood flat bit with 1/4inch Hex shank assortment set in clear case series**

*Clear case*



Diameter mm	Shank Type	Range	Sales Pkg Qty	Part No.
12 to 32	1/4inch Hex MZ	★★★	8	E-08698
			8x10sets	E-08698-10
12 to 32	1/4inch Hex NZ	★★★	8	E-08707
			8x10sets	E-08707-10

**Wood single spur auger bit with Hex shank**



Diameter mm	Length mm	Working Length mm	Range	Sales Pkg Qty	Part No.
6	200	130	★★★	1	D-07238
6	250	180	★★★	1	D-07331
8	200	130	★★★	1	D-07244
8	250	180	★★★	1	D-07347
8	400	330	★★★	1	D-07434
8	450	380	★★★	1	D-07559
10	200	130	★★★	1	D-07250
10	250	180	★★★	1	D-07353
10	400	330	★★★	1	D-07440
10	450	380	★★★	1	D-07565
12	200	130	★★★	1	D-07266
12	250	180	★★★	1	D-07369
12	400	330	★★★	1	D-07456
12	450	380	★★★	1	D-07571
13	250	180	★★★	1	D-53475
13	450	380	★★★	1	D-53497
14	200	130	★★★	1	D-07272
14	250	180	★★★	1	D-07375
14	400	330	★★★	1	D-07462
14	450	380	★★★	1	D-07587
15	250	180	★★★	1	D-53481
15	450	380	★★★	1	D-53506
16	200	130	★★★	1	D-07288
16	250	180	★★★	1	D-07381
16	400	330	★★★	1	D-07478
16	450	380	★★★	1	D-07593
18	200	130	★★★	1	D-07294
18	250	180	★★★	1	D-07397
18	400	330	★★★	1	D-07484
18	450	380	★★★	1	D-07602
20	200	130	★★★	1	D-07303
20	250	180	★★★	1	D-07406
20	400	330	★★★	1	D-07490
20	450	380	★★★	1	D-07618
22	200	130	★★★	1	D-07319
22	250	180	★★★	1	D-07412
22	400	330	★★★	1	D-07509
22	450	380	★★★	1	D-07624
24	200	130	★★★	1	D-07325
24	250	180	★★★	1	D-07428
24	400	330	★★★	1	D-07515
24	450	380	★★★	1	D-07630
26	400	330	★★★	1	D-07521
26	450	380	★★★	1	D-07646
28	400	330	★★★	1	D-07537
28	450	380	★★★	1	D-07652
30	400	330	★★★	1	D-07543
30	450	380	★★★	1	D-07668

**Wood single spur auger bit with Hex shank 3D long**



Diameter mm	Length mm	Working Length mm	Range	Sales Pkg Qty	Part No.
6	400	325	★★★★	1	E-07755
8	400	325	★★★★	1	E-07761
9	400	325	★★★★	1	E-07777
10	400	325	★★★★	1	E-07783
10.5	400	325	★★★★	1	E-07799
10.5	500	425	★★★★	1	E-07923
11	400	325	★★★★	1	E-07808
12	400	325	★★★★	1	E-07814
12	500	425	★★★★	1	E-07939
13	400	325	★★★★	1	E-07820
13.5	400	325	★★★★	1	E-07836
13.5	500	425	★★★★	1	E-07945
15	400	325	★★★★	1	E-07842
15	500	425	★★★★	1	E-07951
16	400	325	★★★★	1	E-07858
18	400	325	★★★★	1	E-07864
18	500	425	★★★★	1	E-07967
21	400	325	★★★★	1	E-07870
21	500	425	★★★★	1	E-07973
22	400	325	★★★★	1	E-07886
24	400	325	★★★★	1	E-07892
24	500	425	★★★★	1	E-07989
27	400	325	★★★★	1	E-07901
27	500	425	★★★★	1	E-07995
30	400	325	★★★★	1	E-07917
30	500	425	★★★★	1	E-08006

**Wood single spur auger bit with 1/4inch Hex shank**



Diameter mm	Length mm	Working Length mm	Shank Type	Range	Sales Pkg Qty	Part No.
6	200	130	1/4inch Hex MZ	★★★	1	D-15992
8	200	130		★★★	1	D-16003
10	200	130		★★★	1	D-16019
12	200	130		★★★	1	D-16025
14	200	130		★★★	1	D-16031
16	200	130		★★★	1	D-16047
18	200	130		★★★	1	D-16053
20	200	130		★★★	1	D-16069
21	200	130		★★★	1	D-16075
6	200	130		1/4inch Hex NZ	★★★	1
8	200	130	★★★		1	D-31332
10	200	130	★★★		1	D-31348
12	200	130	★★★		1	D-31354
14	200	130	★★★		1	D-31360
16	200	130	★★★		1	D-31376
18	200	130	★★★		1	D-31382
20	200	130	★★★		1	D-31398
21	200	130	★★★		1	D-31407

**Wood ship auger bit with 7/16inch Hex shank**



Diameter mm	Length mm	Working Length mm	Shank Type	Range	Sales Pkg Qty	Part No.
10	165	100	5/16inch Hex	★★★	1	D-36055
12	165	100		★★★	1	D-36061
10	470	395		★★★	1	D-36192
12	470	395		★★★	1	D-36201
14	165	100		★★★	1	D-36077
14	470	395		★★★	1	D-36217
16	60	100		★★★	1	D-36083
16	470	395		★★★	1	D-36223
18	165	100		★★★	1	D-36099
18	470	395		★★★	1	D-36239
20	165	100		★★★	1	D-36108
20	470	395		★★★	1	D-36245
22	165	100		★★★	1	D-36114
22	470	395		★★★	1	D-36251
24	165	100	7/16inch Hex	★★★	1	D-36120
24	470	395		★★★	1	D-36267
26	165	100		★★★	1	D-36136
26	470	395		★★★	1	D-36273
28	165	100		★★★	1	D-36142
28	470	395		★★★	1	D-36289
30	165	100		★★★	1	D-36158
30	470	395		★★★	1	D-36295
32	165	100		★★★	1	D-36164
32	470	395		★★★	1	D-36304
35	165	100		★★★	1	D-36170
35	470	395		★★★	1	D-36310
38	165	100		★★★	1	D-36186
38	470	395		★★★	1	D-36326

**Wood formwork drill bit**



Diameter mm	Length mm	Working Length mm	Range	Sales Pkg Qty	Part No.
8	400	75	★★★	1	D-70219
8	600	75	★★★	1	D-70334
10	400	87	★★★	1	D-70225
10	600	87	★★★	1	D-70340
12	400	101	★★★	1	D-70231
12	600	101	★★★	1	D-70356
14	400	108	★★★	1	D-70247
14	600	108	★★★	1	D-70362
16	400	100	★★★	1	D-70253
16	600	100	★★★	1	D-70378
18	400	100	★★★	1	D-70269
18	600	100	★★★	1	D-70384
20	400	100	★★★	1	D-70275
20	600	100	★★★	1	D-70390
22	400	100	★★★	1	D-70281
22	600	100	★★★	1	D-70409
24	400	100	★★★	1	D-70297
24	600	100	★★★	1	D-70415
26	400	100	★★★	1	D-70306
26	600	100	★★★	1	D-70421
28	400	100	★★★	1	D-70312
28	600	100	★★★	1	D-70437
30	400	100	★★★	1	D-70328
30	600	100	★★★	1	D-70443

**Wood self feeding bit with 7/16inch Hex shank**



Diameter mm	Length mm	Shank Type	Range	Sales Pkg Qty	Part No.
25	127	7/16inch Hex	★★	1	D-74304
28	127		★★	1	D-74310
32	127		★★	1	D-74326
35	127		★★	1	D-74332
38	127		★★	1	D-74348
45	127		★★	1	D-74354
51	127		★★	1	D-74360
54	127		★★	1	D-74376
57	127		★★	1	D-74382
65	127		★★	1	D-74398
76	127		★★	1	D-74407
92	127		★★	1	D-74413
117	127		★★	1	D-74429

**Wood self feeding bit with 7/16inch Hex shank assortment set in plastic case**



Diameter (inch)	Shank Type	Range	Sales Pkg Qty	Part No.
(1 to 3)	7/16inch Hex	★★	7	D-36005

**Wood self feeding bit with 7/16inch Hex shank extension bar**



Length mm	Shank Type	Range	Sales Pkg Qty	Part No.
140	7/16inch Hex	★★	1	D-74457
305		★★	1	D-74463
457		★★	1	D-74479

**Wood self feeding bit with 7/16inch Hex shank spare part**



Diameter mm	Range	Sales Pkg Qty	Part No.
For 25 to 65	★★	1	D-74435
For 76 to 117	★★	1	D-74441

**Wood forstner bit**



Diameter mm	Length mm	Range	Sales Pkg Qty	Part No.
10	90	★★	1	D-41844
15	90	★★	1	D-41925
20	90	★★	1	D-42232
25	90	★★	1	D-42248
26	90	★★	1	D-42254
30	90	★★	1	D-42260
32	90	★★	1	D-42276
35	90	★★	1	D-42282
40	90	★★	1	D-42298
50	90	★★	1	D-42307

**Wood forstner bit assortment set in MDF case**



Diameter mm	Length mm	Range	Sales Pkg Qty	Part No.
15, 20, 25, 30, 35	90	★★★	5	D-47363

**Wood TCT hinge cutting bit**



Diameter mm	Length mm	Range	Sales Pkg Qty	Part No.
15	77	★★	1	D-71093
16	77	★★	1	D-74681
18	77	★★	1	D-74697
19	77	★★	1	D-71102
20	77	★★	1	D-71118
22	77	★★	1	D-74706
23	77	★★	1	D-74712
25	77	★★	1	D-71124
26	77	★★	1	D-71130
30	77	★★	1	D-71146
32	77	★★	1	D-71152
35	77	★★	1	D-71168

**Wood shiitake drill bit**



Diameter mm	Length mm	Working Length mm	Range	Sales Pkg Qty	Part No.
12	76	45	Specialized	1	B-49753

**Masonry TCT drill bit with 1/4inch Hex shank**

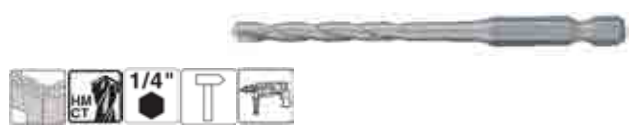

Diameter mm	Length mm	Working Length mm	Shank Type	Range	Sales Pkg Qty	Part No.
3	80	35	1/4inch Hex MZ	★★	1	D-23771
4	80	35		★★	1	D-23787
5	90	45		★★	1	D-23793
6	100	55		★★	1	D-23802
8	100	55		★★	1	D-23818
3	80	35	1/4inch Hex NZ	★★	1	D-31463
3.2	80	35		★★	1	D-63694
4	80	35		★★	1	D-31479
5	90	45		★★	1	D-31485
6	100	55		★★	1	D-31491
6.5	100	55		★★	1	D-55061
8	100	55		★★	1	D-31500

**Drill bit assortment set in plastic case**



Diameter mm (inch)	Range	Sales Pkg Qty	Part No.
Metal 5, 6, 8, Wood 6, 8	★★★	5	D-30106
(Metal 3/16, 1/4, 5/16, Wood 1/4, 5/16)	★★★	5	D-30112
Masonry 5.5, 7, 8, Metal 5.5, 7, 8, Wood 5.5, 7, 8	★★★	9	D-71978
Masonry 5, 6, 8, Metal 5, 6, 8, Wood 5, 6, 8	★★★	9	D-71962
Masonry 3 to 8, Metal 3 to 8, Wood 3 to 8	★★★	21	B-44884
Masonry 4 to 10, Metal 4 to 10, Wood 4 to 10	★★★	18	B-49432

**Drill bit assortment set in metal case**

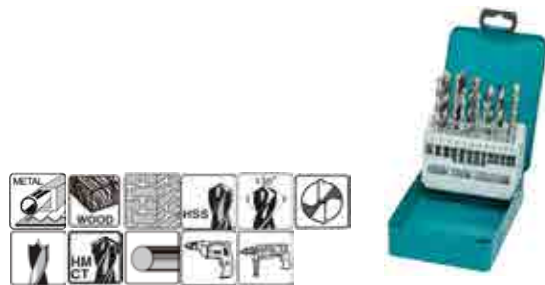

Diameter mm	Range	Sales Pkg Qty	Part No.
Masonry 3 to 10, Metal 3 to 10, Wood 3 to 10	★★★	18	D-46202

**Drill bit with 1/4inch Hex shank assortment set in plastic case**



Diameter mm	Shank Type	Range	Sales Pkg Qty	Part No.
Metal 5, 6, 8, Wood 5, 6	1/4inch Hex MZ	★★★	5	D-20769
Masonry 6, Metal 5, 6, Wood 5, 6	1/4inch Hex MZ	★★★	5	D-23759

Diameter mm	Shank Type	Range	Sales Pkg Qty	Part No.
Metal 5, 6, 8, Wood 5, 6	1/4inch Hex NZ	★★★	5	D-31516
Masonry 6, Metal 5, 6, Wood 5, 6	1/4inch Hex NZ	★★★	5	D-31522

**Drill bit for SDS-PLUS Hammers assortment set in plastic case**



Diameter mm	Shank Type	Range	Sales Pkg Qty	Part No.
Metal 3, 4, Wood 4, 5, 6	SDS-PLUS	★★★	5	B-57532

**Adjustable circle cutter**

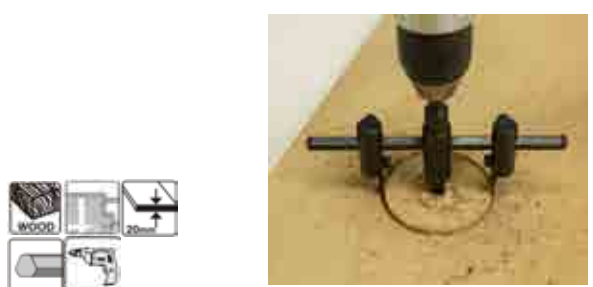

Diameter mm	Range	Sales Pkg Qty	Part No.
30 to 120	★★	1	D-57093
30 to 200	★★	1	D-57102

**Adjustable circle cutter spare part**



Range	Sales Pkg Qty	Part No.
★★	2	D-57118

**Glass bit**



Diameter mm	Length mm	Range	Sales Pkg Qty	Part No.
3	65	★★★	1	D-25111
4	65	★★★	1	D-25127
5	65	★★★	1	D-25133
6	65	★★★	1	D-25149
8	70	★★★	1	D-25155
10	80	★★★	1	D-25161
12	80	★★★	1	D-25177

**Glass bit with 1/4inch Hex shank**



Diameter mm	Length mm	Shank Type	Range	Sales Pkg Qty	Part No.
4	65	1/4inch Hex MZ	★★★	1	D-15942
5	65		★★★	1	D-15958
6	65		★★★	1	D-15964
8	70		★★★	1	D-15970
10	80	★★★	1	D-15986	
4	65	1/4inch Hex NZ	★★★	1	D-31413
5	65		★★★	1	D-31429
6	65		★★★	1	D-31435
8	70		★★★	1	D-31441
10	80	★★★	1	D-31457	

**Earth auger drill bit with 3/4inch SQ shank**



Diameter mm	Length mm	Working Length mm	Shank Type	Range	Sales Pkg Qty	Part No.
20	600	530	3/4inch SQ	Specialized	1	B-54302
25				Specialized	1	B-54318
30				Specialized	1	B-54324
35				Specialized	1	B-54330
40				Specialized	1	B-57576

**Earth auger drill bit with 3/4inch SQ shank spare part**



Diameter mm	Length mm	Working Length mm	Note	Range	Sales Pkg Qty	Part No.
20	600	530	Spare bit	Specialized	1	B-54346
25				Specialized	1	B-54352
30				Specialized	1	B-54368
35				Specialized	1	B-54374
40				Specialized	1	B-57582
-	-	-	Spare socket, pin and O-ring	Specialized	1	B-54380
-	-	-	Spare pin	Specialized	1	B-54396
-	-	-	Spare O-ring	Specialized	1	B-54405

## Earth auger drill bit with adapter D shank



Suitable for drilling sandy soil and soil which contains grassroots and pebbles.  
Used for topdressing · tree planting to fruit trees and also for drilling prepared hole which needs for hammering in various types of pile.

### Earth auger drill bit

Diameter	Length	Working Length	Part No.
<b>NEW</b> ø50 mm	800 mm	550 mm	E-13611
<b>NEW</b> ø60 mm			E-13627
<b>NEW</b> ø80 mm			E-13633
ø100 mm			E-07294
ø150 mm			E-07303
ø200 mm			E-07319

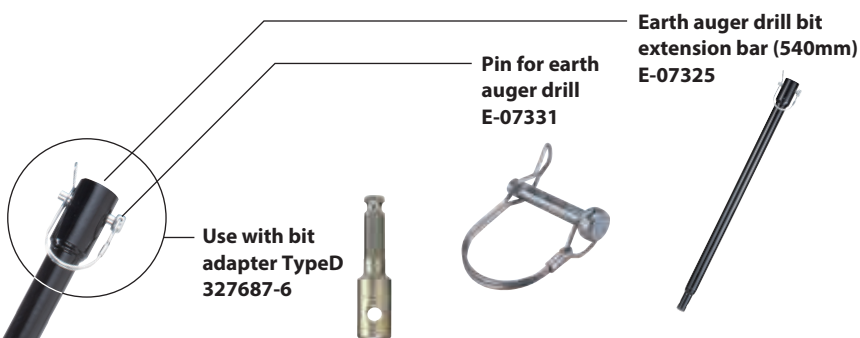

Compared to our conventional product which only has one spiral groove, this new product has two spiral groove which make drilling more stable. It also leads to 10% increase on drilling speed compared to the conventional product.

**Two different types of cutting edge shape (flat cutter and sharp cutter) makes it possible to deal with various soil.**

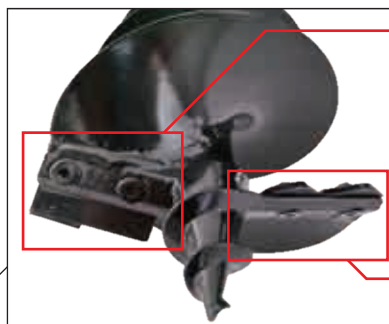

**Flat cutter**



Flat cutter is suitable for soil with grassroots

**Sharp cutter**



Sharp cutter is suitable for soil with pebbles.

**Blade for earth auger drill bit**  
(Changing cutter blade set)

Diameter	Part No.	Diameter	Part No.
<b>NEW</b> For 50 mm	E-13649	For 100 mm	E-07630
<b>NEW</b> For 60 mm	E-13655	For 150 mm	E-07646
<b>NEW</b> For 80 mm	E-13661	For 200 mm	E-07652

\*Diameter 200mm is used only for sandy soil.

# Holesaw

**Ezychange holesaw**

**Ezychange**  
**Bi-Metal HSS 8%Co**  
**Ezychange**  
**TCT**

**One click**  
easy to change the holesaw

Bi-Metal

TCT

for 11mm / 13mm drill

**Easy to remove the dust**  
with pilot drill bit.

**Added extension bar**  
(150/300mm)  
for 13mm drill

## **Ezychange** **Bi-Metal HSS 8%Co**

Variable pitch for faster cutting.

Thanks to 44mm capacity, users can drill into 38mm 2x4 material certainly.

It can make holes in 3mm thick stainless steel by HSS BiM with 8% Co.

## **Ezychange** **TCT**

TCT for high durability

Designed 60mm work length to be able to make a hole in composite material with plywood and 2x4 or 2x6 by 1 shot.

It can make holes in 3mm thick stainless steel and more material than BiM by TCT.

### BiM holesaw

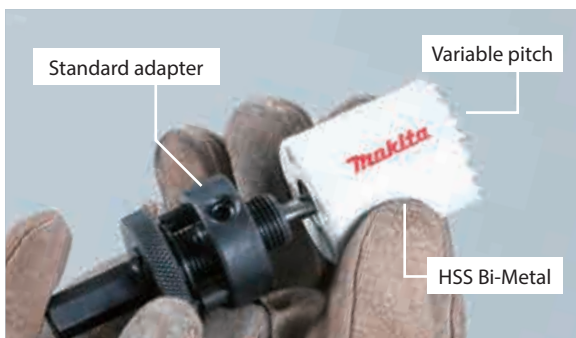

### BiM holesaw for sheet metal

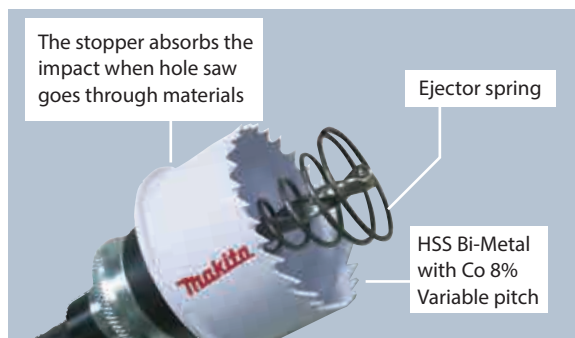

### Multi purpose TCT holesaw

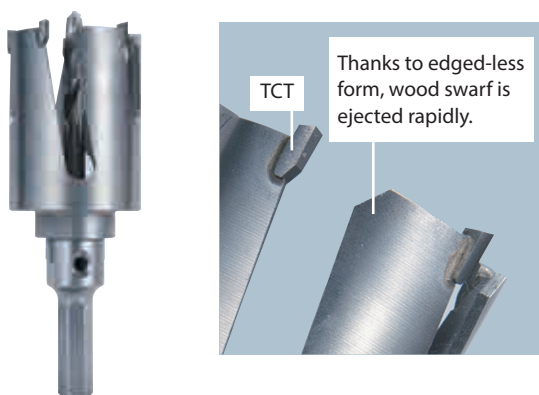

### TCT holesaw

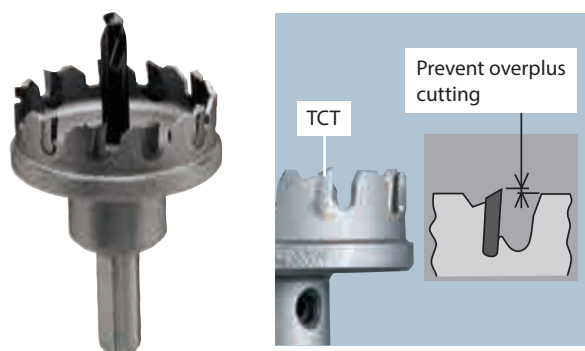

### TC grit holesaw



### Vacuum brazed diamond holesaw

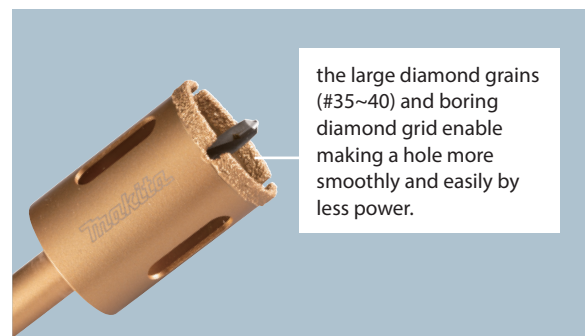

### Diamond wet holesaw

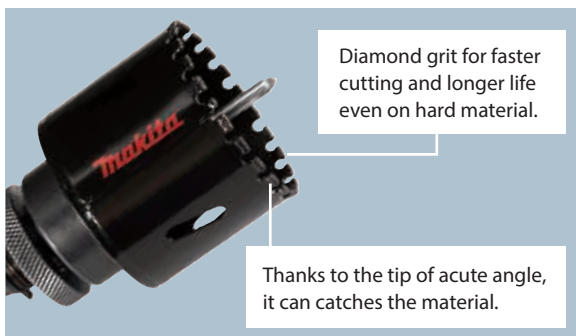

### Carbon steel holesaw

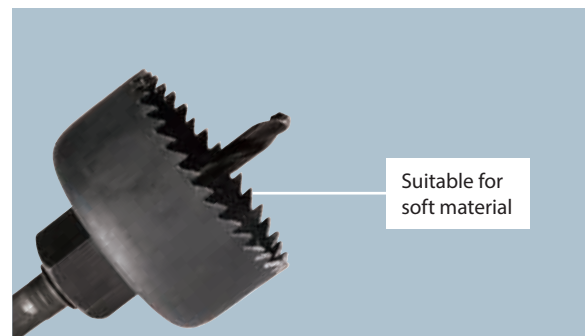



### Ezychange BiM holesaw

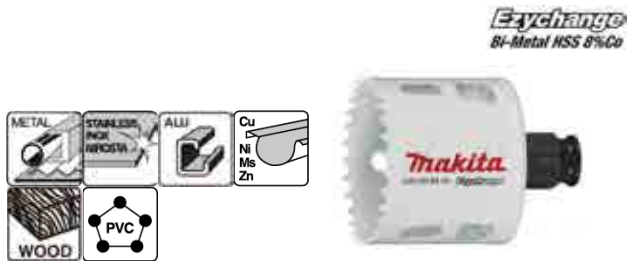

Size mm	Note	Range	Sales Pkg Qty	Part No.
16		★★★★	1	E-03632
17		★★★★	1	E-03648
19		★★★★	1	E-03654
20		★★★★	1	E-03660
22		★★★★	1	E-03676
24		★★★★	1	E-03682
25		★★★★	1	E-03698
27		★★★★	1	E-03707
29		★★★★	1	E-03713
30		★★★★	1	E-03729
32		★★★★	1	E-03735
35		★★★★	1	E-03741
37		★★★★	1	E-03757
38		★★★★	1	E-03763
40		★★★★	1	E-03779
41		★★★★	1	E-03785
44		★★★★	1	E-03791
46		★★★★	1	E-03800
48		★★★★	1	E-03816
51		★★★★	1	E-03822
52		★★★★	1	E-03838
54	Cutting depth 44mm	★★★★	1	E-03844
56		★★★★	1	E-03850
57		★★★★	1	E-03866
60		★★★★	1	E-03872
64		★★★★	1	E-03888
65		★★★★	1	E-03894
68		★★★★	1	E-03903
70		★★★★	1	E-03919
73		★★★★	1	E-03925
76		★★★★	1	E-03931
79	★★★★	1	E-03947	
83	★★★★	1	E-03953	
86	★★★★	1	E-03969	
92	★★★★	1	E-03975	
95	★★★★	1	E-03981	
102	★★★★	1	E-03997	
105	★★★★	1	E-04008	
111	★★★★	1	E-04014	
114	★★★★	1	E-04020	
121	★★★★	1	E-04036	
127	★★★★	1	E-04042	
140	★★★★	1	E-04058	
152	★★★★	1	E-04064	

### Ezychange BiM holesaw adapter



Shank dia. mm	Note	Range	Sales Pkg Qty	Part No.
9.5	With HSS-G pilot drill bit	★★★★	1	E-04070

### Ezychange BiM holesaw pilot drill



Note	Range	Sales Pkg Qty	Part No.
For steel, etc (HSS-G)	★★★★	1	E-04086
For stainless (HSS-Co)	★★★★	1	E-04092

### Ezychange BiM holesaw assortment

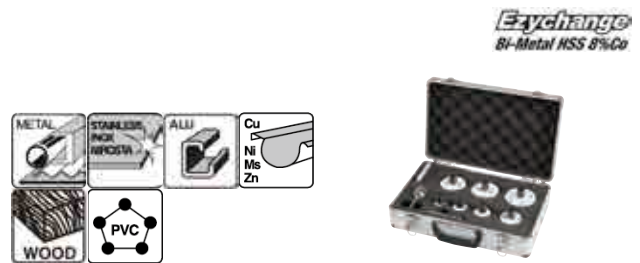

Size mm	Shank dia. mm	Range	Sales Pkg Qty	Part No.
16 to 51	9.5	★★★★	7	E-12310
19 to 57	9.5	★★★★	7	E-12304
20 to 65	9.5	★★★★	7	E-12326
25 to 76	9.5	★★★★	9	E-12295

### Ezychange TCT holesaw

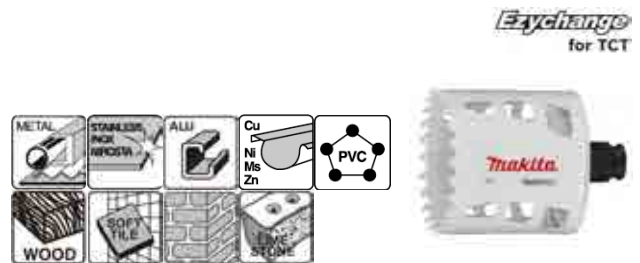

Size mm	Note	Range	Sales Pkg Qty	Part No.
20		★★★★	1	E-06644
22		★★★★	1	E-06650
25		★★★★	1	E-06666
32		★★★★	1	E-06672
35		★★★★	1	E-06688
38		★★★★	1	E-06694
40		★★★★	1	E-06703
44		★★★★	1	E-06719
51		★★★★	1	E-06725
54	Cutting depth 60mm	★★★★	1	E-06731
60		★★★★	1	E-06747
64		★★★★	1	E-06753
67		★★★★	1	E-06769
68		★★★★	1	E-06775
70		★★★★	1	E-06781
73		★★★★	1	E-06797
76		★★★★	1	E-06806
83		★★★★	1	E-06812
102		★★★★	1	E-06828
127	★★★★	1	E-06834	

### Ezychange TCT holesaw adapter



Shank dia. mm	Note	Range	Sales Pkg Qty	Part No.
9.5	With TCT pilot drill bit	★★★★	1	E-06959

### Ezychange TCT holesaw pilot drill



Note	Range	Sales Pkg Qty	Part No.
For steel, etc (HSS-G)	★★★★	1	E-06840
For stainless (HSS-Co)	★★★★	1	E-06856
For masonry (TCT)	★★★★	1	E-06862

Size mm		Range	Sales Pkg Qty	Part No.
80		★★	1	D-33869
83		★★	1	D-17120
86		★★	1	D-35536
89		★★	1	D-35542
92		★★	1	D-17136
95		★★	1	D-35558
98		★★	1	D-35564
102	Cutting depth 38mm	★★	1	D-35570
105		★★	1	D-17142
108		★★	1	D-35586
111		★★	1	D-35592
114		★★	1	D-35601
121		★★	1	D-35617
127		★★	1	D-17158
140		★★	1	D-35623
152	★★	1	D-17164	

### Ezychange holesaw extension bar



Size mm	Shank dia. mm	Note	Range	Sales Pkg Qty	Part No.
150	11	For Ezychange BiM/TCT Holesaw	★★★★	1	E-06878
300	11	For Ezychange BiM/TCT Holesaw	★★★★	1	E-06884

### BiM holesaw adapter



Type	Shank dia. mm	Note	Range	Sales Pkg Qty	Part No.
Adapter	9.5	For 14-30mm, With pilot drill bit	★★	1	D-17170
	11	For 32-152mm, With pilot drill bit	★★	1	D-17186
SDS-PLUS adapter	-	For 14-30mm, With pilot drill bit	★★	1	D-17603
	-	For 32-76mm, With pilot drill bit	★★	1	D-17619

### BiM holesaw

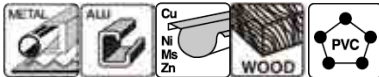

Size mm		Range	Sales Pkg Qty	Part No.
14		★★	1	D-35368
16		★★	1	D-16994
17		★★	1	D-35374
19		★★	1	D-17005
20		★★	1	D-17251
21		★★	1	D-35380
22		★★	1	D-17011
24		★★	1	D-17027
25		★★	1	D-17033
27		★★	1	D-35396
29		★★	1	D-17267
30		★★	1	D-35405
32		★★	1	D-17049
33		★★	1	D-35411
35		★★	1	D-17055
37		★★	1	D-35427
38		★★	1	D-17061
40		★★	1	D-17273
41	Cutting depth 38mm	★★	1	D-35433
43		★★	1	D-35449
44		★★	1	D-17077
46		★★	1	D-35455
48		★★	1	D-35461
51		★★	1	D-17083
52		★★	1	D-35477
54		★★	1	D-24876
56		★★	1	D-35483
57		★★	1	D-17099
59		★★	1	D-35499
60		★★	1	D-25688
64	★★	1	D-30140	
65	★★	1	D-24882	
67	★★	1	D-35508	
68	★★	1	D-17108	
70	★★	1	D-25694	
73	★★	1	D-35514	
76	★★	1	D-17114	
79	★★	1	D-35520	

### BiM holesaw pilot drill



Range	Sales Pkg Qty	Part No.
★★	1	D-17192

### BiM holesaw assortment



Size mm	Shank dia. mm	Range	Sales Pkg Qty	Part No.
22 to 35	9.5	★★	5	D-34855
22 to 51	9.5, 11	★★	6	D-34861
20 to 65	9.5, 11	★★	9	D-47139
19 to 57	9.5, 11	★★	9	D-47117
19 to 57	9.5, 11	★★	9	D-63965
16 to 51	9.5, 11	★★	9	D-47123
19 to 68	9.5, 11	★★	12	D-47282
19 to 68	9.5, 11	★★	12	D-63987
19 to 75	9.5, 11	★★	14	D-47298
19 to 75	9.5, 11	★★	14	D-50572
19 to 75	9.5, 11	★★	14	D-63971
16 to 76	9.5, 11	★★	16	D-47307
16 to 76	9.5, 11	★★	16	D-63993
22 to 32	9.5	★★	5x14sets	D-33641-14
22 to 32	9.5	★★	6x14sets	D-33819-14
22 to 51	9.5	★★	6x10sets	D-33657-10
22 to 51	9.5	★★	7x10sets	D-33825-10

**BiM holesaw for sheet metal**

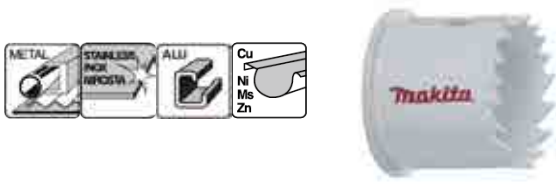

Size mm	Note	Range	Sales Pkg Qty	Part No.
16		★★★	1	B-29670
17		★★★	1	B-29686
19		★★★	1	B-29692
20		★★★	1	B-29701
21		★★★	1	B-29717
22		★★★	1	B-29723
25		★★★	1	B-29739
27		★★★	1	B-29745
29		★★★	1	B-29751
30		★★★	1	B-29767
32		★★★	1	B-29773
33		★★★	1	B-29789
35		★★★	1	B-29795
38		★★★	1	B-29804
40		★★★	1	B-29810
41		★★★	1	B-29826
44		★★★	1	B-29832
48	Cutting depth 20mm	★★★	1	B-29848
51		★★★	1	B-29854
54		★★★	1	B-29860
57		★★★	1	B-29876
60		★★★	1	B-29882
64		★★★	1	B-29898
65		★★★	1	B-35994
67		★★★	1	B-36005
68		★★★	1	B-36011
70		★★★	1	B-36027
73	★★★	1	B-36033	
76	★★★	1	B-36049	
79	★★★	1	B-36055	
83	★★★	1	B-36061	
86	★★★	1	B-36077	
89	★★★	1	B-36083	
102	★★★	1	B-36099	
127	★★★	1	B-36108	
152	★★★	1	B-36114	

**BiM holesaw for sheet metal adapter**



Shank dia. mm	Note	Range	Sales Pkg Qty	Part No.
9.5	For 16-35mm, With HSS pilot drill bit	★★★	1	B-36120
11	For 38-152mm, With HSS pilot drill bit	★★★	1	B-36136

**BiM holesaw for sheet metal pilot drill**



Range	Sales Pkg Qty	Part No.
★★★	1	B-36142

**BiM holesaw for sheet metal assortment**

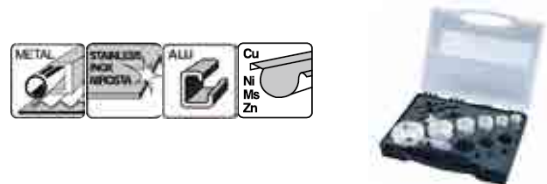

Size mm	Shank dia. mm	Range	Sales Pkg Qty	Part No.
19 to 57	9.5, 11	★★★	15	B-38663
20 to 64	9.5, 11	★★★	15	B-38679

**TCT holesaw**

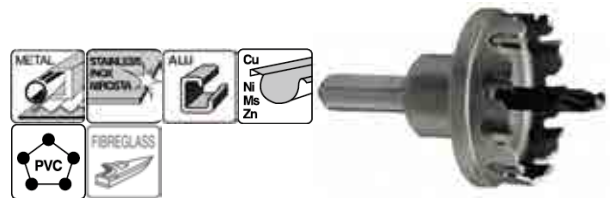

Size mm	Shank dia. mm	Note	Range	Sales Pkg Qty	Part No.
16	6		★★★★★	1	B-00898
18	6		★★★★★	1	B-00907
20	6		★★★★★	1	B-00913
21	6		★★★★★	1	B-00929
22	6		★★★★★	1	B-00935
25	10		★★★★★	1	B-00941
27	10		★★★★★	1	B-00957
28	10		★★★★★	1	B-00963
30	10		★★★★★	1	B-00979
32	10		★★★★★	1	B-00985
35	10		★★★★★	1	B-00991
38	10		★★★★★	1	B-01002
40	10		★★★★★	1	B-01018
45	10	With pilot drill bit	★★★★★	1	B-01024
48	10		★★★★★	1	B-01030
50	10		★★★★★	1	B-01046
55	10		★★★★★	1	B-01052
60	13		★★★★★	1	B-01068
65	13		★★★★★	1	B-01074
68	13		★★★★★	1	B-02652
70	13		★★★★★	1	B-01080
75	13		★★★★★	1	B-01096
80	13		★★★★★	1	B-01105
85	13	★★★★★	1	B-01111	
90	13	★★★★★	1	B-01127	
95	13	★★★★★	1	B-01133	
100	13	★★★★★	1	B-01149	
110	13	★★★★★	1	B-01155	
120	13	★★★★★	1	B-01161	

**TCT holesaw pilot drill**



Note	Range	Sales Pkg Qty	Part No.
For 16-55mm, For steel, etc.	★★★★★	1	B-01177
For 60-120mm, For steel, etc.	★★★★★	1	B-01183
For 16-55mm, For FRP, resin, etc.	★★★★★	1	B-01199
For 60-120mm, For FRP, resin, etc.	★★★★★	1	B-01208

### Multi purpose TCT holesaw

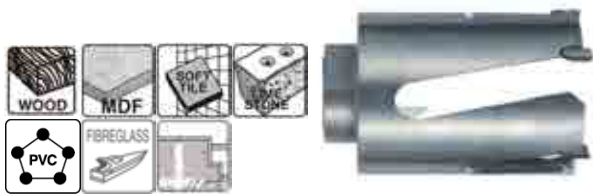

Size mm	Note	Range	Sales Pkg Qty	Part No.
19	Cutting depth 50mm	★★	1	D-42678
22		★★	1	D-42684
25		★★	1	D-42690
29		★★	1	D-42709
30		★★	1	D-42715
32		★★	1	D-42721
35		★★	1	D-42737
38		★★	1	D-42743
40		★★	1	D-42759
45		★★	1	D-42765
48		★★	1	D-42771
50		★★	1	D-42787
51		★★	1	D-42793
54		★★	1	D-42802
55	Cutting depth 60mm	★★	1	D-42818
57		★★	1	D-42824
59		★★	1	D-61488
60		★★	1	D-42830
64		★★	1	D-42846
65		★★	1	D-42852
67		★★	1	D-42868
68		★★	1	D-42874
70		★★	1	D-42880
73		★★	1	D-45026
76		★★	1	D-45032
79		★★	1	D-45048
80		★★	1	D-45331
83		★★	1	D-45347
85		★★	1	D-45353
89		★★	1	D-45369
95	★★	1	D-50304	
102	★★	1	D-50310	
105	★★	1	D-50326	

### Multi purpose TCT holesaw adapter



Type	Shank dia. mm	Note	Range	Sales Pkg Qty	Part No.
Adapter	11	For 22-105mm, With TCT pilot drill bit	★★	1	D-50332
		For 19mm, With TCT pilot drill bit	★★	1	D-50354
		For 22-105mm, With HSS pilot drill bit	★★	1	D-50376
		For 19mm, With HSS pilot drill bit	★★	1	D-50398
SDS-PLUS adapter	-	For 22-32mm, With TCT pilot drill bit	★★	1	D-50348
		For 19mm, With TCT pilot drill bit	★★	1	D-50360
		For 22-32mm, With HSS pilot drill bit	★★	1	D-50382
		For 19mm, With HSS pilot drill bit	★★	1	D-50407

### Multi purpose TCT holesaw pilot drill



Note	Range	Sales Pkg Qty	Part No.
For 19mm, For steel, etc (HSS)	★★	1	D-50435
For 19mm, For masonry (TCT)	★★	1	D-50441
For 22-105mm, For steel, etc (HSS)	★★	1	D-50413
For 22-105mm, For masonry (TCT)	★★	1	D-50429

### Multi purpose TCT holesaw assortment

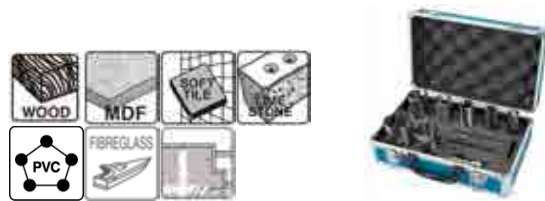

Size mm	Shank dia. mm	Range	Sales Pkg Qty	Part No.
22 to 51	11	★★	10	D-51281
22 to 76	11	★★	9	D-51297

### Tungsten carbide grit holesaw



Size mm	Note	Range	Sales Pkg Qty	Part No.
33	Cutting depth 64mm	★★	1	D-51188
43		★★	1	D-51194
53		★★	1	D-51203
63		★★	1	D-51219
67		★★	1	D-51225
73		★★	1	D-51231
83		★★	1	D-51247

### Tungsten carbide grit holesaw adapter



Shank dia. mm	Note	Range	Sales Pkg Qty	Part No.
11	With TCT pilot drill bit	★★	1	D-51253

### Tungsten carbide grit holesaw pilot drill



Note	Range	Sales Pkg Qty	Part No.
TCT	★★	1	D-51269

### Vacuum brazed diamond holesaw



Size mm	Shank dia. mm	Note	Range	Sales Pkg Qty	Part No.	
16	12.7	Cutting depth 40mm, With shank and pilot drill bit	★★★★	1	B-45870	
19	12.7		★★★★	1	B-45886	
25	12.7		★★★★	1	B-45892	
30	12.7		★★★★	1	B-45901	
32	12.7		★★★★	1	B-45917	
35	12.7		★★★★	1	B-45923	
38	12.7		★★★★	1	B-45939	
45	12.7		★★★★	1	B-45945	
50	12.7		★★★★	1	B-45951	
53	12.7		★★★★	1	B-45967	
57	12.7		★★★★	1	B-45973	
64	12.7		★★★★	1	B-45989	
16	-		Cutting depth 40mm	★★★★	1	B-45995
19	-			★★★★	1	B-46006
25	-	★★★★		1	B-46012	
30	-	★★★★		1	B-46028	
32	-	★★★★		1	B-46034	
35	-	★★★★		1	B-46040	
38	-	★★★★		1	B-46056	
45	-	★★★★		1	B-46062	
50	-	★★★★		1	B-46078	
53	-	★★★★		1	B-46084	
57	-	★★★★		1	B-46090	
64	-	★★★★		1	B-46109	
68	-	★★★★		1	B-53914	

### Vacuum brazed diamond holesaw adapter



Type	Shank dia. mm	Note	Range	Sales Pkg Qty	Part No.
Adapter	12.7	With TCT pilot drill bit	★★★★	1	B-46115
Adapter	12.7	-	★★★★	1	B-46137
SDS-PLUS adapter	-	With pilot drill bit	★★★★	1	B-52691
SDS-PLUS adapter	-	-	★★★★	1	B-52700

### Vacuum brazed diamond holesaw pilot drill



Note	Range	Sales Pkg Qty	Part No.
TCT	★★★★	1	B-46121

### Diamond wet holesaw



Size mm	Note	Range	Sales Pkg Qty	Part No.
19	Cutting depth 38mm	★★	1	D-61210
20		★★	1	D-61226
22		★★	1	D-61232
25		★★	1	D-61248
29		★★	1	D-61254
32		★★	1	D-61260
35		★★	1	D-61276
38		★★	1	D-61282
41		★★	1	D-61298
44		★★	1	D-61307
51		★★	1	D-61313
54		★★	1	D-61329
57		★★	1	D-61335
60		★★	1	D-61341
64	★★	1	D-61357	
65	★★	1	D-61363	
67	★★	1	D-61379	
68	★★	1	D-61385	
70	★★	1	D-61391	
76	★★	1	D-61400	
79	★★	1	D-61416	
83	★★	1	D-61422	

### Diamond wet holesaw adapter



Shank dia. mm	Note	Range	Sales Pkg Qty	Part No.
9.5	For 19-29mm	★★	1	D-61438
11	For 32-83mm	★★	1	D-61444

### Diamond wet holesaw pilot drill



Note	Range	Sales Pkg Qty	Part No.
TCT	★★	1	D-61450

### Carbon steel holesaw assortment

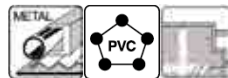

Size mm	Shank dia. mm	Range	Sales Pkg Qty	Part No.
32 to 64	10	★★	6	D-70203

# ACCESSORIES

## ▣ Drilling (Masonry)

# NEMESIS II



Metal, mild steel



Aluminum



Wood



Tile



Concrete



Reinforced concrete



Brick



Granite



Plastic



Asphalt



2cutter



4cutter



Self sharpening



Dustless



Tungsten carbide tip

**TCT drill bit with Straight shank**



Bit dia mm	Length mm	Working Length mm	Range	Sales Pkg Qty	Part No.
3	60	30	★★★★	1	E-06351
3	60	30	★★	1	D-05228
4	70	35	★★★★	1	E-06367
4	70	35	★★	1	D-05234
5	85	45	★★★★	1	E-06373
5	85	45	★★	1	D-05240
5	150	90	★★★★	1	E-06389
5.5	100	60	★★★★	1	E-06395
5.5	100	60	★★	1	D-36728
5.5	150	90	★★★★	1	E-06404
5.5	150	90	★★	1	D-36734
6	100	60	★★★★	1	E-06410
6	100	60	★★	1	D-05256
6	150	90	★★★★	1	E-06426
6	150	90	★★	1	D-05262
6	250	175	★★★★	1	E-06432
6.5	100	55	★★	1	D-36740
6.5	100	60	★★★★	1	E-06448
6.5	150	90	★★★★	1	E-06454
6.5	150	90	★★	1	D-36756
7	100	55	★★★★	1	E-06460
7	100	55	★★	1	D-05278
7	150	90	★★★★	1	E-06476
7	150	90	★★	1	D-05284
8	110	60	★★★★	1	E-06482
8	110	60	★★	1	D-05290
8	150	90	★★★★	1	E-06498
8	150	90	★★	1	D-05309
8	250	175	★★★★	1	E-06507
9	150	90	★★★★	1	E-06513
9	150	90	★★	1	D-05315
10	150	90	★★★★	1	E-06529
10	150	90	★★	1	D-05321
10	250	175	★★★★	1	E-06535
10	400	315	★★	1	D-18960
11	150	90	★★	1	D-05337
12	150	90	★★★★	1	E-06541
12	150	90	★★	1	D-05343
12	250	175	★★★★	1	E-06557
12	400	315	★★	1	D-17697
12	600	505	★★	1	D-17728
13	150	85	★★	1	D-05359
14	150	85	★★★★	1	E-06563
14	150	85	★★	1	D-05365
14	250	175	★★★★	1	E-06579
14	400	315	★★	1	D-18976
15	150	85	★★	1	D-05371
16	150	85	★★★★	1	E-06585
16	150	85	★★	1	D-05387
16	400	315	★★	1	D-17706
16	600	505	★★	1	D-17734
18	200	135	★★★★	1	E-06591
18	400	315	★★	1	D-18982
20	200	135	★★★★	1	E-06600
20	400	315	★★	1	D-17712
20	600	505	★★	1	D-17740

**TCT drill bit with Straight shank multiple**



Bit dia mm	Length mm	Working Length mm	Range	Sales Pkg Qty	Part No.
3	60	30	★★	5	D-71788
4	70	35	★★	5	D-71794
5	85	45	★★	5	D-71803
6	100	60	★★	5	D-71819

Bit dia mm	Length mm	Working Length mm	Range	Sales Pkg Qty	Part No.
6	150	90	★★	5	D-71825
6.5	100	55	★★	5	D-71831
7	100	60	★★	5	D-16508
8	110	60	★★	5	D-16514
8	110	60	★★	5	D-71847
8	150	90	★★	5	D-71853
10	150	90	★★	5	D-71869

**TCT drill bit with Straight shank assortment set in plastic case**

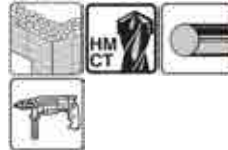

Size mm	Range	Sales Pkg Qty	Part No.
4x70, 5x85, 6x100, 8x110, 10x110	★★	5	D-05175
4x70, 5x85, 6x100, 8x110, 10x150	★★★★	5	E-11536
5x85, 5.5x100, 6.5x100, 8x150, 10x150	★★	5	D-36762
5x110, 6x110, 7x110, 8x110, 10x110	★★	5	D-20719
4x70, 5x85, 5.5x85, 5.5x85, 6x100, 6x100, 6.5x100, 6.5x100, 7x100, 7x100, 8x110, 8x110	★★	12	D-73483

**TCT drill bit with Straight shank Brick**



Bit dia mm	Length mm	Working Length mm	Range	Sales Pkg Qty	Part No.
3	60	30	★★	1	D-40727
3.5	75	40	★★	1	D-40733
4	75	40	★★	1	D-40749
4.5	85	55	★★	1	D-40755
5	85	55	★★	1	D-40761
5	150	100	★★	1	D-40777
5.5	85	55	★★	1	D-40783
5.5	150	100	★★	1	D-40799
6	100	60	★★	1	D-40808
6	150	100	★★	1	D-40814
6	200	130	★★	1	D-40820
6	400	350	★★	1	D-40836
6.5	100	60	★★	1	D-40842
6.5	150	100	★★	1	D-40858
6.5	400	350	★★	1	D-40864
7	100	60	★★	1	D-40870
7	150	100	★★	1	D-40886
7	400	350	★★	1	D-40892
8	120	80	★★	1	D-40901
8	150	100	★★	1	D-40917
8	200	130	★★	1	D-40923
8	400	350	★★	1	D-40939
9	120	80	★★	1	D-40945
10	120	80	★★	1	D-40951
10	150	100	★★	1	D-40967
10	200	130	★★	1	D-40973
10	400	350	★★	1	D-40989
11	150	100	★★	1	D-40995
12	150	100	★★	1	D-41006
12	200	130	★★	1	D-41012
12	400	350	★★	1	D-41028

### TCT drill bit with Straight shank Brick assortment set

Carbide Tipped for Longer Life



Size mm	Range	Sales Pkg Qty	Part No.
5x85, 6x100, 8x120	★★	3	D-41034

### TCT drill bit with Straight shank Brick assortment set in plastic case



Size mm	Range	Sales Pkg Qty	Part No.
4x75, 5x85, 6x100, 8x120, 10x120	★★	5	D-41040
4x75, 5x85, 6x100, 8x120, 10x120	★★	5	D-72877
3x60, 4x75, 5x85, 6x100, 7x100, 8x120, 9x120, 10x120	★★	8	D-41791

### TCT drill bit with Straight shank Multi material Renge (★★★)



Possible to drill holes in various work materials without changing drill bits. Available for Hammer drill and Driver drill. Without impact, it is suitable for wood, iron, aluminum and tile. With impact, it is suitable for concrete blocks and bricks.



#### 4-side grinfing and sharp cutting edge

It makes possible to drill holes in various work materials and also improves drilling speed.



#### Outstanding durability

High quality tangsten carbide tip is used.

\*Renge (★★) can't use matal drilling.

Bit dia mm	Length mm	Working Length mm	Range	Sales Pkg Qty	Part No.
3	60	28	★★	1	D-30287
3	70	38	★★★	1	E-10958
4	70	35	★★	1	
4	75	40	★★★	1	E-10964
5	85	43	★★★	1	E-10970
5	85	43	★★	1	D-30302
5.5	85	43	★★	1	D-31027
5.5	100	50	★★★	1	E-10986
5.5	100	58	★★	1	D-31033
5.5	150	108	★★	1	D-31049
6	100	50	★★★	1	E-10992
6	100	58	★★	1	D-30318
6	150	90	★★★	1	E-11003
6	150	108	★★	1	D-30324
6	200	120	★★	1	D-72774

Bit dia mm	Length mm	Working Length mm	Range	Sales Pkg Qty	Part No.
6	250	170	★★	1	D-72780
6	300	200	★★	1	D-72796
6.5	85	43	★★	1	D-31055
6.5	100	50	★★★	1	E-11019
6.5	100	58	★★	1	D-31061
6.5	150	90	★★★	1	E-11025
6.5	150	108	★★	1	D-31077
6.5	200	120	★★	1	D-72805
6.5	250	170	★★	1	D-72811
6.5	300	200	★★	1	D-72827
7	100	50	★★★	1	E-11031
7	100	53	★★	1	D-30330
7	150	103	★★	1	D-30346
8	110	57	★★	1	D-30352
8	120	60	★★★	1	E-11047
8	150	90	★★★	1	E-11053
8	150	97	★★	1	D-30368
9	150	97	★★	1	D-30374
10	150	90	★★★	1	E-11069
10	150	97	★★	1	D-30380
10	400	300	★★	1	D-30396
11	150	93	★★	1	D-30405
12	150	90	★★★	1	E-11075
12	150	93	★★	1	D-30411
12	400	300	★★	1	D-30427
12	600	500	★★	1	D-30433
13	150	85	★★	1	D-30449
13	150	90	★★★	1	E-11081
14	150	85	★★	1	D-30455
14	400	300	★★	1	D-30461

### TCT drill bit with Straight shank Multi material multiple



Bit dia mm	Length mm	Working Length mm	Range	Sales Pkg Qty	Part No.
3	60	28	★★	5	D-71875
4	70	35	★★	5	D-71881
5	85	43	★★	5	D-71897
6	100	58	★★	5	D-71906
6	150	108	★★	5	D-71912
8	110	57	★★	5	D-71928
8	150	97	★★	5	D-71934
10	150	97	★★	5	D-71940







### TCT drill bit with Straight shank Multi material assortment set in plastic case



Size mm	Range	Sales Pkg Qty	Part No.
4x70, 5x85, 6x100, 8x150, 10x150	★★	5	D-36712
5x85, 6x100, 8x110, 10x150, 12x150	★★	5	D-30477
5.5x85, 6.5x100, 8x110, 10x150, 12x150	★★	5	D-36974





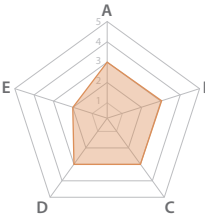
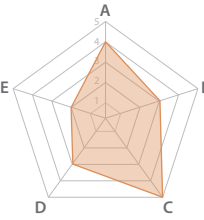
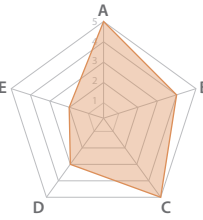
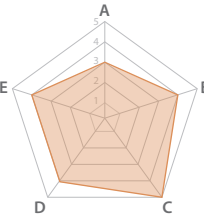
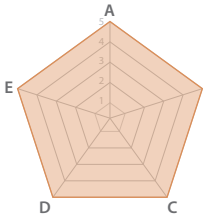
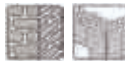
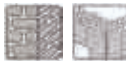
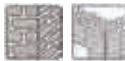
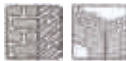
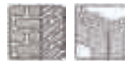





## T.C.T drill bit for SDS-PLUS Hammers

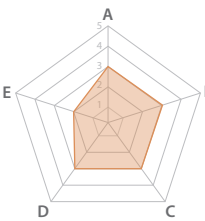
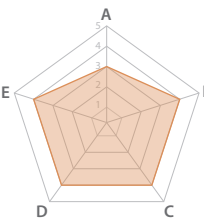
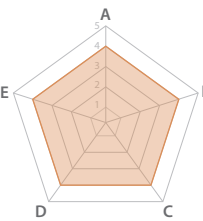

Product	Standard type	Centering Tip	Centering Tip V-PLUS	4 cutter	NEMESIS II
Range	★★	★★★	★★★★★	★★★★	★★★★★★
Carbide					
Tip	2 Cutter	Centering tip 2 Cutter	Centering tip 2 Cutter	Centering tip 4 Cutter	Full carbide tip 4 Cutter 
Flute	Standard 2 flute	Standard 2 flute	High Durability 2 flute	Standard 2 flute	High Durability 4 flute
Size	3.5 - 30mm 5/32" - 1"	4 - 32mm 5/32" - 1"	3.5-26mm	5 - 25mm	5 - 32mm 5/32" - 1-1/4"
Chart					
Work material					

## T.C.T drill bit for SDS-MAX Hammers



Product	Standard type	4 cutter	NEMESIS	Mining
Range	★★	★★★	★★★★★	Specialized
Carbide				
Tip	2 Cutter	Centering tip 4 cutter	Centering tip 4 Cutter 	4 Cutter 
Flute	Standard 2 flute	Standard 2 flute	High Durability 4 flute	High Durability 2 flute
Size	12-40mm 1/2" - 1-1/2"	12-30mm	12-40mm 1/2" - 1-1/2"	28-32mm
Chart				Specialized
Work material				

## TCT drill bit for SDS-PLUS hammers

Carbide Tipped for Longer Life



Bit dia mm	Length mm	Working Length mm	Range	Sales Pkg Qty	Part No.
3.5	90	30	★★	1	D-16950
3.5	110	50	★★	1	D-15665
4	110	50	★★	1	D-00016
4	160	100	★★	1	D-66612
4.3	110	50	★★	1	D-01096
5	110	50	★★	1	D-00022
5	160	100	★★	1	D-00038
5	210	150	★★	1	D-66628
5.5	110	50	★★	1	D-00044
5.5	160	100	★★	1	D-16106
5.8	110	50	★★	1	D-03268
6	110	50	★★	1	D-00050
6	160	100	★★	1	D-00066
6	210	150	★★	1	D-00072
6	260	200	★★	1	D-25666
6.4	160	100	★★	1	D-01105
6.5	110	50	★★	1	D-00088
6.5	160	100	★★	1	D-00094
6.5	210	150	★★	1	D-45082
6.5	260	200	★★	1	D-66634
7	110	50	★★	1	D-00103
7	160	100	★★	1	D-00119
7	210	150	★★	1	D-25600
8	110	50	★★	1	D-00125
8	160	100	★★	1	D-00131
8	210	150	★★	1	D-00147
8	260	200	★★	1	D-00153
8	310	250	★★	1	D-66640
8	460	400	★★	1	D-29206
8.5	160	100	★★	1	D-01111
9	110	50	★★	1	D-08040
9	160	100	★★	1	D-08056
9	210	150	★★	1	D-00169
9.5	160	100	★★	1	D-34344
9.5	210	150	★★	1	D-03274
10	110	50	★★	1	D-09117
10	160	100	★★	1	D-00175
10	210	150	★★	1	D-00181
10	260	200	★★	1	D-00197
10	310	250	★★	1	D-00206
10	350	290	★★	1	D-66656
10	460	400	★★	1	D-17538
10.5	160	100	★★	1	D-01127
11	160	100	★★	1	D-00212
11	210	150	★★	1	D-66662
11	260	200	★★	1	D-66678
12	160	100	★★	1	D-00228
12	210	150	★★	1	D-00234
12	260	200	★★	1	D-00240
12	310	250	★★	1	D-66684
12	350	290	★★	1	D-16112
12	460	400	★★	1	D-16271
12.5	160	100	★★	1	D-14102
12.7	160	100	★★	1	D-03280
12.7	350	290	★★	1	D-03296
13	160	100	★★	1	D-00256
13	210	150	★★	1	D-66690
13	260	200	★★	1	D-25622
13	350	290	★★	1	D-16128
14	160	100	★★	1	D-00262
14	210	150	★★	1	D-21331
14	260	200	★★	1	D-00278
14	310	250	★★	1	D-66709
14	350	290	★★	1	D-16134
14	460	400	★★	1	D-17544
14.3	160	100	★★	1	D-03997
14.5	160	100	★★	1	D-01149

Bit dia mm	Length mm	Working Length mm	Range	Sales Pkg Qty	Part No.
15	160	100	★★	1	D-00284
15	260	200	★★	1	D-25638
15	350	290	★★	1	D-16140
15	460	400	★★	1	D-17550
16	160	100	★★	1	D-03981
16	210	150	★★	1	D-00290
16	260	200	★★	1	D-16156
16	310	250	★★	1	D-00309
16	350	290	★★	1	D-16162
16	460	400	★★	1	D-16287
16	460	400	★★	1	D-29103
17	160	100	★★	1	D-16178
17	210	150	★★	1	D-00315
17	260	200	★★	1	D-16184
17	350	290	★★	1	D-16190
17.5	160	100	★★	1	D-03305
18	160	100	★★	1	D-16209
18	210	150	★★	1	D-00321
18	260	200	★★	1	D-16215
18	300	240	★★	1	D-00337
18	350	290	★★	1	D-16221
18	460	400	★★	1	D-17566
19	210	150	★★	1	D-00343
19	350	290	★★	1	D-16243
19	460	400	★★	1	D-16293
20	210	150	★★	1	D-00359
20	260	200	★★	1	D-16259
20	310	250	★★	1	D-00365
20	350	290	★★	1	D-16265
20	460	400	★★	1	D-15235
22	260	200	★★	1	D-00371
22	310	250	★★	1	D-08062
22	460	400	★★	1	D-15241
24	260	200	★★	1	D-25644
24	460	400	★★	1	D-16302
25	260	200	★★	1	D-00387
25	310	250	★★	1	D-08517
25	350	290	★★	1	D-03311
25	460	400	★★	1	D-15257
26	260	200	★★	1	D-00393
26	310	250	★★	1	D-08078
26	460	400	★★	1	D-15263
28	460	400	★★	1	D-16318
30	460	400	★★	1	D-17572

## TCT drill bit for SDS-PLUS hammers multiple



Bit dia mm	Length mm	Working Length mm	Range	Sales Pkg Qty	Part No.
5	110	50	★★	25	D-01155-25
5	110	50	★★	25	D-65115
5	160	100	★★	25	D-61949
5	160	100	★★	50	D-61955
5.5	110	50	★★	25	D-03763-25
5.5	160	100	★★	25	D-03779-25
6	110	50	★★	25	D-01161-25
6	110	50	★★	25	D-61612
6	110	50	★★	50	D-61628
6	160	100	★★	25	D-01177-25
6	160	100	★★	25	D-61961
6	160	100	★★	50	D-61977
6.5	110	50	★★	25	D-03785-25
6.5	110	50	★★	25	D-61983
6.5	110	50	★★	50	D-61999
6.5	160	100	★★	25	D-03791-25
6.5	160	100	★★	25	D-62000
6.5	160	100	★★	50	D-62016
6.5	210	150	★★	10	D-45098
6.5	210	150	★★	25	D-45107

Bit dia mm	Length mm	Working Length mm	Range	Sales Pkg Qty	Part No.
7	110	50	★★	25	D-03800-25
7	160	100	★★	25	D-03816-25
7	160	100	★★	25	D-62131
7	160	100	★★	50	D-62147
8	110	50	★★	25	D-61634
8	110	50	★★	50	D-61640
8	160	100	★★	25	D-01183-25
8	160	100	★★	25	D-62022
8	160	100	★★	50	D-62038
8	210	150	★★	25	D-01199-25
8	210	150	★★	25	D-65121
8	260	200	★★	25	D-06161-25
10	110	50	★★	25	D-61656
10	110	50	★★	50	D-61662
10	160	100	★★	25	D-01208-25
10	160	100	★★	25	D-62044
10	160	100	★★	50	D-62050
10	210	150	★★	25	D-03707-25
10	210	150	★★	25	D-65137
12	160	100	★★	25	D-03713-25
12	160	100	★★	25	D-62066
12	160	100	★★	50	D-62072
12	210	150	★★	15	D-65143
12	210	150	★★	25	D-03729-25
12	260	200	★★	15	D-65159
12	350	290	★★	15	D-65165
13	160	100	★★	15	D-65171
14	160	100	★★	15	D-65187
14	210	150	★★	15	D-65193
16	160	100	★★	15	D-65202
16	210	150	★★	15	D-65218

**TCT drill bit for SDS-PLUS hammers assortment set in cardboard box**



Size mm	Range	Sales Pkg Qty	Part No.
5x110, 6x110, 7x110, 8x110, 6x160, 7x160, 8x160, 10x160, 12x160, 14x160, 10x210, 12x210, 14x210, 16x210	★★	14	D-71956

**TCT drill bit for SDS-PLUS hammers assortment set in plastic case**



Size mm	Range	Sales Pkg Qty	Part No.
5x110, 6x160, 8x160, 10x160	★★	4	D-74136
6.5x160, 8x160, 10x160, 12x160	★★	4	D-74728
5x110, 6x110, 6x160, 8x110, 8x160	★★	5	D-00795
5x160, 6x160, 7x160, 8x160, 10x160	★★	5	D-20703
5x160, 6x160, 6x160, 8x160, 8x160	★★	5	D-58914
6x110, 6.5x110, 8x160, 10x160, 12x160	★★	5	D-17784
5.5x110, 6x160, 7x110, 7x160, 8x160	★★	5	D-03888
5.8x110, 6.5x110, 6.5x160, 9.5x160, 12.7x160	★★	5	D-44987
6x110, 6x160, 8x110, 8x160, 10x160	★★	5	D-61678
6x160, 6x160, 8x160, 10x160, 12x160	★★	5	D-36049
6x160, 8x160, 10x160, 12x160	★★	12	D-62723
5x110, 6x110, 6x160, 8x110, 8x160	★★	10	D-40593
5x110, 6x110, 6x160, 7x110, 7x160	★★	25	D-33853
5x110, 6x110, 6x160, 8x110, 8x160	★★	25	D-40602
5.5x110, 5.5x160, 6.5x110, 6.5x160, 8x160	★★	25	D-46268

**TCT drill bit for SDS-PLUS hammers assortment set in roll up pouch**



Size mm	Range	Sales Pkg Qty	Part No.
5x110, 6x110, 6x160, 7x110, 7x160, 8x110, 8x160, 10x160, 10x210, 12x160, 12x210, 14x160, 14x210, 16x210	★★	14	D-53665
5x110, 6x110, 6x160, 7x110, 7x160, 8x110, 8x160, 10x160, 10x210, 12x160, 12x210, 14x160, 14x210, 16x210	★★	14	D-53671

**TCT drill bit for SDS-PLUS hammers assortment set in aluminum case**



Size mm	Range	Sales Pkg Qty	Part No.
5x110, 6x110, 6x160, 7x110, 7x160, 8x110, 8x160, 10x160, 10x210, 12x160, 12x210, 14x160, 14x210, 16x210	★★	14	D-21325

**TCT drill bit for SDS-PLUS hammers assortment set in aluminum case with Makita blue**



Size mm	Range	Sales Pkg Qty	Part No.
5x110, 6x110, 6x160, 7x110, 7x160, 8x110, 8x160, 10x160, 10x210, 12x160, 12x210, 14x160, 14x210, 16x210	★★	14	D-42422

**TCT drill bit for SDS-PLUS hammers Centering tip**



Bit dia mm	Length mm	Working Length mm	Range	Sales Pkg Qty	Part No.
4	110	50	★★★	1	B-55859
4	160	100	★★★	1	B-67804
5	110	50	★★★	1	B-54128
5	160	100	★★★	1	B-54134

Bit dia mm	Length mm	Working Length mm	Range	Sales Pkg Qty	Part No.
5	210	150	★★★	1	B-67810
5.5	110	50	★★★	1	B-55865
5.5	160	100	★★★	1	B-55871
5.5	210	150	★★★	1	B-67826
6	110	50	★★★	1	B-54140
6	160	100	★★★	1	B-54156
6	210	150	★★★	1	B-54162
6	260	200	★★★	1	B-67832
6.5	110	50	★★★	1	B-55887
6.5	160	100	★★★	1	B-55893
6.5	210	150	★★★	1	B-55902
6.5	260	200	★★★	1	B-55918
7	110	50	★★★	1	B-55924
7	160	100	★★★	1	B-55930
7	210	150	★★★	1	B-55946
8	110	50	★★★	1	B-54178
8	160	100	★★★	1	B-54184
8	210	150	★★★	1	B-55952
8	260	200	★★★	1	B-55968
8	310	250	★★★	1	B-67848
8	400	340	★★★	1	B-67854
8	460	400	★★★	1	B-68046
9	160	100	★★★	1	B-55974
9	210	150	★★★	1	B-67860
10	110	50	★★★	1	B-55980
10	160	100	★★★	1	B-54190
10	210	150	★★★	1	B-54209
10	260	200	★★★	1	B-55996
10	310	250	★★★	1	B-56007
10	350	290	★★★	1	B-67876
10	450	400	★★★	1	B-56013
11	160	100	★★★	1	B-67882
11	210	150	★★★	1	B-67898
11	260	200	★★★	1	B-67907
12	160	100	★★★	1	B-54215
12	210	150	★★★	1	B-54221
12	260	200	★★★	1	B-56029
12	310	250	★★★	1	B-67913
12	350	290	★★★	1	B-56035
12	450	400	★★★	1	B-56041
13	160	100	★★★	1	B-56057
13	210	150	★★★	1	B-67929
13	260	200	★★★	1	B-67935
14	160	100	★★★	1	B-56063
14	210	150	★★★	1	B-56079
14	260	200	★★★	1	B-56085
14	310	250	★★★	1	B-67941
14	350	290	★★★	1	B-56091
14	450	400	★★★	1	B-56100
15	160	100	★★★	1	B-67957
15	260	200	★★★	1	B-67963
15	460	400	★★★	1	B-68052
16	160	100	★★★	1	B-56116
16	210	150	★★★	1	B-56122
16	260	200	★★★	1	B-67979
16	310	250	★★★	1	B-56138
16	350	290	★★★	1	B-56144
16	450	400	★★★	1	B-56150
17	210	140	★★★	1	B-56465
17	350	270	★★★	1	B-56471
18	210	150	★★★	1	B-62125
18	310	250	★★★	1	B-67985
18	350	290	★★★	1	B-62131
18	460	400	★★★	1	B-68068
19	210	150	★★★	1	B-62147
19	350	290	★★★	1	B-62153
20	210	150	★★★	1	B-62169
20	310	250	★★★	1	B-67991
20	350	290	★★★	1	B-62175
20	460	400	★★★	1	B-68074
22	210	150	★★★	1	B-62181
22	260	200	★★★	1	B-68002
22	350	290	★★★	1	B-62197
22	460	400	★★★	1	B-68080
24	210	150	★★★	1	B-62206
24	260	200	★★★	1	B-68018
24	350	290	★★★	1	B-62212
24	460	400	★★★	1	B-68096
25	210	150	★★★	1	B-62228
25	260	200	★★★	1	B-68024

Bit dia mm	Length mm	Working Length mm	Range	Sales Pkg Qty	Part No.
25	350	290	★★★	1	B-62234
25	460	400	★★★	1	B-68105
26	260	200	★★★	1	B-68030
26	460	400	★★★	1	B-68111
28	210	150	★★★	1	B-62240
28	350	290	★★★	1	B-62256
30	210	150	★★★	1	B-62262
30	350	290	★★★	1	B-62278
32	350	290	★★★	1	B-62284

### TCT drill bit for SDS-PLUS hammers Centering tip multiple

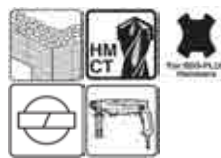

Bit dia mm	Length mm	Working Length mm	Range	Sales Pkg Qty	Part No.
4	110	50	★★★	5	B-60224
5	110	50	★★★	5	B-60230
5	160	100	★★★	5	B-60246
5.5	110	50	★★★	5	B-60252
5.5	160	100	★★★	5	B-60268
6	110	50	★★★	5	B-60274
6	160	100	★★★	5	B-60280
6	160	100	★★★	10	B-59271
6	210	150	★★★	5	B-61597
6	210	150	★★★	10	B-59287
6.5	110	50	★★★	5	B-60296
6.5	160	100	★★★	5	B-60305
6.5	160	100	★★★	10	B-59293
6.5	160	100	★★★	25	B-59318
6.5	210	150	★★★	5	B-61606
6.5	210	150	★★★	10	B-59302
6.5	210	150	★★★	25	B-59324
7	110	50	★★★	5	B-60311
7	160	100	★★★	5	B-60327
8	110	50	★★★	5	B-60333
8	160	100	★★★	5	B-60349
9	160	100	★★★	5	B-60355
10	110	50	★★★	5	B-60361
10	160	100	★★★	5	B-60377
12	160	100	★★★	5	B-60383
13	160	100	★★★	5	B-61612
14	160	100	★★★	5	B-61628
14	210	150	★★★	5	B-61634
17	210	150	★★★	5	B-61640

### TCT drill bit for SDS-PLUS hammers Centering tip assortment set in plastic case



Size mm	Range	Sales Pkg Qty	Part No.
5.0x160, 5.5x160, 6.0x160, 6.5x160, 8.0x160	★★★	5	B-57021
5x110, 6x110, 6x160, 8x110, 8x160	★★★	5	B-54710
5.5x160, 6.0x160, 6.5x160, 8.0x160, 10x160	★★★	5	B-57037
6x110, 8x160, 8x160, 10x160, 10x160	★★★	5	B-54704
6x110, 6x110, 8x160, 8x160, 10x160	★★★	5	B-55784
B-54710x5sets, B-55784x5sets	★★★	5x10sets	B-56421

TCT drill bit for SDS-PLUS hammers V-PLUS

**V-PLUS**

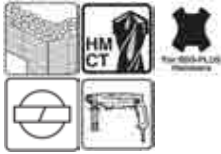

Bit dia mm	Length mm	Working Length mm	Range	Sales Pkg Qty	Part No.
3.5	110	50	★★★★	1	E-10665
4	110	50	★★★★	1	B-47232
4	160	100	★★★★	1	B-47248
4.5	160	100	★★★★	1	E-10671
5	110	50	★★★★	1	B-46492
5	140	80	★★★★	1	B-47254
5	160	100	★★★★	1	B-46501
5	210	150	★★★★	1	B-47260
5	260	200	★★★★	1	B-47276
5	310	250	★★★★	1	B-47282
5	450	390	★★★★	1	B-60408
5.5	110	50	★★★★	1	B-47298
5.5	160	100	★★★★	1	B-47307
5.5	210	150	★★★★	1	B-47313
5.5	260	200	★★★★	1	B-47329
5.5	310	250	★★★★	1	B-47335
6	110	50	★★★★	1	B-46517
6	160	100	★★★★	1	B-46523
6	210	150	★★★★	1	B-47341
6	260	200	★★★★	1	B-47357
6	310	250	★★★★	1	B-47363
6	460	400	★★★★	1	B-47379
6.5	110	50	★★★★	1	B-47385
6.5	160	100	★★★★	1	B-47391
6.5	210	150	★★★★	1	B-47400
6.5	260	200	★★★★	1	B-47416
6.5	310	250	★★★★	1	B-47422
7	110	50	★★★★	1	B-47438
7	160	100	★★★★	1	B-47444
7	210	150	★★★★	1	B-47450
7	250	190	★★★★	1	B-47466
8	110	50	★★★★	1	B-46539
8	160	100	★★★★	1	B-46545
8	210	150	★★★★	1	B-47472
8	260	200	★★★★	1	B-47488
8	310	250	★★★★	1	B-47494
8	400	340	★★★★	1	B-47503
8	460	400	★★★★	1	B-47519
8	600	540	★★★★	1	B-47525
9	160	100	★★★★	1	B-47531
9	210	150	★★★★	1	B-47547
9.5	160	100	★★★★	1	B-47553
9.5	310	250	★★★★	1	B-51409
10	110	50	★★★★	1	B-46551
10	160	100	★★★★	1	B-46567
10	210	150	★★★★	1	B-47569
10	260	200	★★★★	1	B-47575
10	310	250	★★★★	1	B-47581
10	350	290	★★★★	1	B-47597
10	450	390	★★★★	1	B-47606
10	600	540	★★★★	1	B-47612
10	800	740	★★★★	1	B-47628
10	1000	940	★★★★	1	B-47634
11	160	110	★★★★	1	B-47640
11	210	160	★★★★	1	B-47656
11	260	210	★★★★	1	B-47662
11	310	260	★★★★	1	B-47678
12	160	110	★★★★	1	B-46573
12	210	160	★★★★	1	B-47684
12	260	210	★★★★	1	B-47690
12	310	260	★★★★	1	B-47709
12	360	310	★★★★	1	B-47715
12	450	400	★★★★	1	B-47721
12	600	550	★★★★	1	B-47737
12	800	750	★★★★	1	B-47743
12	1000	950	★★★★	1	B-47759
13	160	110	★★★★	1	B-47765

Bit dia mm	Length mm	Working Length mm	Range	Sales Pkg Qty	Part No.
13	210	160	★★★★	1	B-47771
13	260	210	★★★★	1	B-47787
13	310	260	★★★★	1	B-47793
14	160	110	★★★★	1	B-46589
14	210	160	★★★★	1	B-47802
14	260	210	★★★★	1	B-47818
14	310	260	★★★★	1	B-47824
14	450	400	★★★★	1	B-47830
14	600	550	★★★★	1	B-47846
14	1000	950	★★★★	1	B-47852
15	160	110	★★★★	1	B-47868
15	210	160	★★★★	1	B-47874
15	260	210	★★★★	1	B-47880
15	450	400	★★★★	1	B-47896
16	160	110	★★★★	1	B-47905
16	210	160	★★★★	1	B-47911
16	260	210	★★★★	1	B-47927
16	310	260	★★★★	1	B-47933
16	450	400	★★★★	1	B-47949
16	600	550	★★★★	1	B-47955
16	800	750	★★★★	1	B-47961
16	1000	950	★★★★	1	B-47977
17	210	160	★★★★	1	B-47983
17	450	400	★★★★	1	B-47999
18	200	150	★★★★	1	B-48000
18	300	250	★★★★	1	B-48016
18	450	400	★★★★	1	B-48022
18	600	550	★★★★	1	B-48038
18	1000	950	★★★★	1	B-48044
19	200	150	★★★★	1	B-48050
19	450	400	★★★★	1	B-48066
20	200	150	★★★★	1	B-48072
20	300	250	★★★★	1	B-48088
20	450	400	★★★★	1	B-48094
20	600	550	★★★★	1	B-48103
20	800	750	★★★★	1	B-48119
20	1000	950	★★★★	1	B-48125
22	250	200	★★★★	1	B-48131
22	450	400	★★★★	1	B-48147
22	600	550	★★★★	1	B-48153
22	1000	950	★★★★	1	B-48169
23	250	200	★★★★	1	B-48175
23	450	400	★★★★	1	B-48181
24	250	200	★★★★	1	B-48197
24	450	400	★★★★	1	B-48206
24	600	550	★★★★	1	B-48212
25	250	200	★★★★	1	B-48228
25	450	400	★★★★	1	B-48234
25	600	550	★★★★	1	B-48240
25	1000	950	★★★★	1	B-48256
26	250	200	★★★★	1	B-48262
26	450	400	★★★★	1	B-48278

TCT drill bit for SDS-PLUS hammers V-PLUS multiple

**V-PLUS**



Bit dia mm	Length mm	Working Length mm	Range	Sales Pkg Qty	Part No.
5	110	50	★★★★	5	B-46492-5
5	110	50	★★★★	10	B-46492-10
5	110	50	★★★★	25	B-46492-25
5	110	50	★★★★	50	B-46492-50
5	160	100	★★★★	10	B-46501-10
5	160	100	★★★★	25	B-46501-25
5	160	100	★★★★	50	B-46501-50
5.5	110	50	★★★★	5	B-47298-5
6	110	50	★★★★	5	B-46517-5
6	110	50	★★★★	10	B-46517-10
6	110	50	★★★★	50	B-46517-50
6	160	100	★★★★	5	B-46523-5

Bit dia mm	Length mm	Working Length mm	Range	Sales Pkg Qty	Part No.
6	160	100	★★★★	10	B-46523-10
6	160	100	★★★★	25	B-46523-25
6	160	100	★★★★	50	B-46523-50
6	210	150	★★★★	5	B-47341-5
6	210	150	★★★★	10	B-47341-10
6	210	150	★★★★	25	B-47341-25
6	210	150	★★★★	50	B-47341-50
6.5	110	50	★★★★	5	B-47385-5
6.5	160	100	★★★★	5	B-47391-5
6.5	210	150	★★★★	25	B-47400-25
6.5	260	200	★★★★	25	B-47416-25
8	110	50	★★★★	5	B-46539-5
8	110	50	★★★★	10	B-46539-10
8	110	50	★★★★	50	B-46539-50
8	160	100	★★★★	5	B-46545-5
8	160	100	★★★★	10	B-46545-10
8	160	100	★★★★	25	B-46545-25
8	160	100	★★★★	50	B-46545-50
8	210	150	★★★★	5	B-47472-5
8	210	150	★★★★	10	B-47472-10
8	210	150	★★★★	25	B-47472-25
8	210	150	★★★★	50	B-47472-50
8	260	200	★★★★	25	B-47488-25
8	310	250	★★★★	25	B-47494-25
10	110	50	★★★★	10	B-46551-10
10	110	50	★★★★	50	B-46551-50
10	160	100	★★★★	5	B-46567-5
10	160	100	★★★★	10	B-46567-10
10	160	100	★★★★	25	B-46567-25
10	160	100	★★★★	50	B-46567-50
10	210	150	★★★★	5	B-47569-5
10	210	150	★★★★	10	B-47569-10
10	210	150	★★★★	25	B-47569-25
10	210	150	★★★★	50	B-47569-50
10	260	200	★★★★	25	B-47575-25
12	160	110	★★★★	5	B-46573-5
12	160	110	★★★★	10	B-46573-10
12	160	110	★★★★	25	B-46573-25
12	210	160	★★★★	5	B-47684-5
12	210	160	★★★★	10	B-47684-10
12	210	160	★★★★	25	B-47684-25

**TCT drill bit for SDS-PLUS hammers V-PLUS assortment set in plastic case**

**V-PLUS**

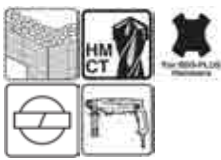

Size mm	Range	Sales Pkg Qty	Part No.
5x110, 6x110, 8x110, 6x160, 8x160	★★★★	5	B-49052
5x110, 6x110, 6x160, 8x160, 10x160	★★★★	5	B-49133
5x110, 6x160, 8x160, 10x160, 12x160	★★★★	5	B-49074
5x110, 6x110, 6x160, 8x110, 8x160, 10x160, 12x160	★★★★	7	B-49046
5x110, 6x110, 6x160, 8x160, 10x160, 10x210, 12x210	★★★★	10	B-49127
5x110, 6x160, 8x160	★★★★	12	B-49111
5x110, 6x160, 8x160, 10x160, 12x160	★★★★	12	B-49096
6x160, 8x160, 10x160, 12x160	★★★★	12	B-49105
6x110, 6x160, 8x160, 10x160, 12x160, 14x160, 16x160	★★★★	12	B-49080

**TCT drill bit for SDS-PLUS hammers 4cutter**



Bit dia mm	Length mm	Working Length mm	Range	Sales Pkg Qty	Part No.
5	110	50	★★★★	1	B-68127
5	160	100	★★★★	1	B-68133
5	210	150	★★★★	1	B-68149
5	260	200	★★★★	1	B-68155
6	110	50	★★★★	1	B-62496
6	160	100	★★★★	1	B-62505
6	210	150	★★★★	1	B-62511
6	260	200	★★★★	1	B-62527
6	310	250	★★★★	1	B-68161
6.5	110	50	★★★★	1	B-62533
6.5	160	100	★★★★	1	B-62549
6.5	210	150	★★★★	1	B-62555
6.5	260	200	★★★★	1	B-62561
7	110	50	★★★★	1	B-62577
7	160	100	★★★★	1	B-62583
7	210	150	★★★★	1	B-62599
8	110	50	★★★★	1	B-62608
8	160	100	★★★★	1	B-62614
8	210	150	★★★★	1	B-62620
8	260	200	★★★★	1	B-62636
8	310	250	★★★★	1	B-62642
8	460	400	★★★★	1	B-62658
10	110	50	★★★★	1	B-62664
10	160	100	★★★★	1	B-62670
10	210	150	★★★★	1	B-62686
10	260	200	★★★★	1	B-62692
10	310	250	★★★★	1	B-62701
10	350	290	★★★★	1	B-62717
10	460	400	★★★★	1	B-62723
12	160	100	★★★★	1	B-62739
12	210	150	★★★★	1	B-62745
12	260	200	★★★★	1	B-62751
12	310	250	★★★★	1	B-62767
12	350	290	★★★★	1	B-62773
12	460	400	★★★★	1	B-62789
14	160	100	★★★★	1	B-62795
14	210	150	★★★★	1	B-62804
14	260	200	★★★★	1	B-62810
14	310	250	★★★★	1	B-62826
14	350	290	★★★★	1	B-62832
14	460	400	★★★★	1	B-62848
16	160	100	★★★★	1	B-62854
16	210	150	★★★★	1	B-62860
16	260	200	★★★★	1	B-62876
16	310	250	★★★★	1	B-62882
16	350	290	★★★★	1	B-62898
16	460	400	★★★★	1	B-62907
18	260	200	★★★★	1	B-68177
18	460	400	★★★★	1	B-68236
20	260	200	★★★★	1	B-68183
20	460	400	★★★★	1	B-68242
22	260	200	★★★★	1	B-68199
22	460	400	★★★★	1	B-68258
25	260	200	★★★★	1	B-68208
25	460	400	★★★★	1	B-68264



**Centering tip**

Stable and secure drilling

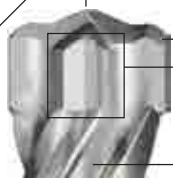

Solid TCT (5 - 16mm)  
Three piece TCT (18 - 32mm)

**Wearing mark**

Indicator for evaluating the dimensional stability of the anchor holes

**Innovated flute geometry**

Faster drilling

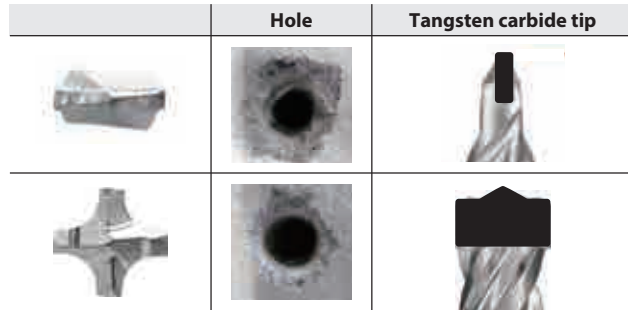

The drilling hole is closer to a circle than 2cutter.  
Lifetime is longer than 2cutter because of big TCT.

**Rebar chamfer**

Reduce shock in reinforcement strikes

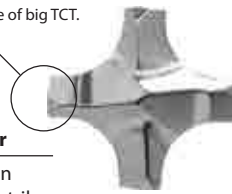

**TCT drill bit for SDS-PLUS hammers Nemesis II**



Bit dia mm	Length mm	Working Length mm	Range	Sales Pkg Qty	Part No.
5	115	50	★★★★★	1	B-57897
5	165	100	★★★★★	1	B-57906
5	215	150	★★★★★	1	B-57912
5	265	200	★★★★★	1	B-57928
5	315	250	★★★★★	1	B-57934
5.5	115	50	★★★★★	1	B-57940
5.5	165	100	★★★★★	1	B-57956
6	115	50	★★★★★	1	B-57962
6	165	100	★★★★★	1	B-57978
6	215	150	★★★★★	1	B-57984
6	265	200	★★★★★	1	B-57990
6	315	250	★★★★★	1	B-58001
6.5	165	100	★★★★★	1	B-58023
6.5	215	150	★★★★★	1	B-58039
6.5	265	200	★★★★★	1	B-58045
6.5	315	250	★★★★★	1	B-58051
7	115	50	★★★★★	1	B-58067
7	165	100	★★★★★	1	B-58073
7	215	150	★★★★★	1	B-58089
8	115	50	★★★★★	1	B-58095
8	165	100	★★★★★	1	B-58104
8	215	150	★★★★★	1	B-58110
8	265	200	★★★★★	1	B-58126
8	315	250	★★★★★	1	B-58132
8	465	400	★★★★★	1	B-58154
9	165	100	★★★★★	1	B-58176
9	265	200	★★★★★	1	B-58182
10	115	50	★★★★★	1	B-58198
10	165	100	★★★★★	1	B-58207
10	215	150	★★★★★	1	B-58213
10	265	200	★★★★★	1	B-58229
10	315	250	★★★★★	1	B-58235
10	455	390	★★★★★	1	B-58257
10	600	540	★★★★★	1	B-58263
10	1000	940	★★★★★	1	B-58279

Bit dia mm	Length mm	Working Length mm	Range	Sales Pkg Qty	Part No.
11	165	100	★★★★★	1	E-14495
11	215	150	★★★★★	1	E-14504
11	265	200	★★★★★	1	E-14510
11	315	250	★★★★★	1	E-14526
12	165	100	★★★★★	1	E-14532
12	215	150	★★★★★	1	E-14548
12	265	200	★★★★★	1	E-14554
12	315	250	★★★★★	1	E-14560
12	455	390	★★★★★	1	E-14576
12	600	550	★★★★★	1	E-14582
12	1000	950	★★★★★	1	B-58388
13	165	100	★★★★★	1	E-14598
13	215	150	★★★★★	1	E-14607
13	265	200	★★★★★	1	E-14613
13	315	250	★★★★★	1	E-14629
14	165	100	★★★★★	1	E-14635
14	215	150	★★★★★	1	E-14641
14	265	200	★★★★★	1	E-14657
14	315	250	★★★★★	1	E-14663
14	455	390	★★★★★	1	E-14679
14	600	550	★★★★★	1	E-14685
14	1000	950	★★★★★	1	B-58497
15	165	100	★★★★★	1	E-14691
15	215	150	★★★★★	1	E-14700
15	265	200	★★★★★	1	E-14716
15	455	390	★★★★★	1	E-14722
16	165	100	★★★★★	1	E-14738
16	215	150	★★★★★	1	E-14744
16	265	200	★★★★★	1	E-14750
16	315	250	★★★★★	1	E-14766
16	455	390	★★★★★	1	E-14772
16	600	550	★★★★★	1	E-14788
16	1000	950	★★★★★	1	B-58609
18	250	200	★★★★★	1	B-58615
18	450	400	★★★★★	1	B-58621
20	250	200	★★★★★	1	B-58637
20	450	400	★★★★★	1	B-58659
22	250	200	★★★★★	1	B-58665
22	450	400	★★★★★	1	B-58687
24	250	200	★★★★★	1	B-58693
24	450	400	★★★★★	1	B-58702
25	250	200	★★★★★	1	B-58718
25	450	400	★★★★★	1	B-58724
28	250	200	★★★★★	1	B-58746
28	450	400	★★★★★	1	B-58752
30	250	200	★★★★★	1	B-58768
30	450	400	★★★★★	1	B-58774
32	450	400	★★★★★	1	B-58780

### TCT drill bit for SDS-PLUS hammers Nemesis II multiple



Bit dia mm	Length mm	Working Length mm	Range	Sales Pkg Qty	Part No.
5	115	50	★★★★★	5	B-58796
5	115	50	★★★★★	10	B-63214
5	165	100	★★★★★	10	B-63220
5.5	115	50	★★★★★	5	B-58805
5.5	115	50	★★★★★	10	B-63236
5.5	165	100	★★★★★	10	B-63242
6	115	50	★★★★★	5	B-58811
6	115	50	★★★★★	10	B-63258
6	165	100	★★★★★	5	B-58827
6	165	100	★★★★★	10	B-63264
6	215	150	★★★★★	5	B-58833
6	215	150	★★★★★	10	B-63270
6	265	200	★★★★★	10	B-63286
6	315	250	★★★★★	10	B-63292
6.5	165	100	★★★★★	5	B-58849
6.5	165	100	★★★★★	10	B-63301
6.5	215	150	★★★★★	10	B-63317
6.5	265	200	★★★★★	10	B-63323
6.5	315	250	★★★★★	10	B-63339
7	115	50	★★★★★	10	B-63345
7	165	100	★★★★★	10	B-63351
8	115	50	★★★★★	5	B-58883
8	115	50	★★★★★	10	B-63367
8	165	100	★★★★★	5	B-58899
8	165	100	★★★★★	10	B-63373
8	215	150	★★★★★	5	B-58908
8	215	150	★★★★★	10	B-63389
8	265	200	★★★★★	10	B-63395
10	115	50	★★★★★	10	B-63404
10	165	100	★★★★★	5	B-58914
10	165	100	★★★★★	10	B-63410
10	215	150	★★★★★	5	B-58920
10	215	150	★★★★★	10	B-63426
10	265	200	★★★★★	10	B-63432
10	315	250	★★★★★	10	B-63448
12	165	100	★★★★★	5	E-14794
12	215	150	★★★★★	5	E-14803
12	265	200	★★★★★	5	E-14819
12	165	100	★★★★★	10	E-14825
12	215	150	★★★★★	10	E-14831
12	265	200	★★★★★	10	E-14847
12	315	250	★★★★★	10	E-14853
14	165	100	★★★★★	10	E-14869
14	215	150	★★★★★	10	E-14875
14	265	200	★★★★★	10	E-14881
14	315	250	★★★★★	10	E-14897

### TCT drill bit for SDS-PLUS hammers Nemesis II assortment set in plastic case



Size mm	Range	Sales Pkg Qty	Part No.
5x115, 6x115, 8x115	★★★★★	3	B-58986
6x165, 8x165, 10x165	★★★★★	3	B-59075
6.5x165, 8x165, 10x165	★★★★★	3	B-59097
5x115, 6x115, 6x165, 8x165, 8x165	★★★★★	5	B-58992

Size mm	Range	Sales Pkg Qty	Part No.
5.5x115, 7x115, 6x165, 7x165, 8x165	★★★★★	5	B-59003
5x115, 6x11, 6x165, 8x115, 8x165mm, 10x165, 12x165	★★★★★	7	E-14928
5x165, 6x215, 6.5x215, 6.5x265, 8x265, 10x265, 12x265	★★★★★	7	E-14906
5.5x115, 5.5x165, 6x115, 6.5x165, 7x165, 8x165, 10x165	★★★★★	7	B-59053
5x165, 6x165, 6x165, 6x165, 8x165, 8x165, 8x165, 10x165, 10x165, 10x165, 12x165, 12x165	★★★★★	12	E-14912

### TCT drill bit for SDS-PLUS hammers Dustless



Bit dia mm	Length mm	Working Length mm	Range	Sales Pkg Qty	Part No.
12	330	200	Specialized	1	B-64381
14	360	240	Specialized	1	B-64397
16	360	240	Specialized	1	B-64406
18	360	240	Specialized	1	B-64412

### TCT drill bit for SDS-MAX hammers



Bit dia mm	Length mm	Working Length mm	Range	Sales Pkg Qty	Part No.
12	340	200	★★	1	D-33875
12	540	400	★★	1	D-33881
12.7	340	200	★★	1	D-54994
14	340	200	★★	1	D-33897
14	540	400	★★	1	D-33906
14.3	340	200	★★	1	D-55011
15	340	200	★★	1	D-33912
15	540	400	★★	1	D-33928
16	340	200	★★	1	D-33934
16	540	400	★★	1	D-33940
18	340	200	★★	1	D-33956
18	540	400	★★	1	D-33962
19	340	200	★★	1	D-55033
19	540	400	★★	1	D-55055
20	340	200	★★	1	D-33978
20	540	400	★★	1	D-33984
22	340	200	★★	1	D-33990
22	540	400	★★	1	D-34001
24	340	200	★★	1	D-34017
24	540	400	★★	1	D-34023
25	340	200	★★	1	D-34039
25	540	400	★★	1	D-34045
28	370	250	★★	1	D-34051
28	570	450	★★	1	D-34067
30	370	250	★★	1	D-34073
30	570	450	★★	1	D-34089
32	370	250	★★	1	D-34095
32	570	450	★★	1	D-34104
35	370	250	★★	1	D-34110
35	570	450	★★	1	D-34126
38	370	250	★★	1	D-34132
38	570	450	★★	1	D-34148
40	370	250	★★	1	D-34154
40	570	450	★★	1	D-34160

**TCT drill bit for SDS-MAX hammers assortment set in plastic case**



Size mm	Range	Sales Pkg Qty	Part No.
16x340, 18x340, 20x340	★★	3	D-40587

**TCT drill bit for SDS-MAX hammers 4cutter**



Bit dia mm	Length mm	Working Length mm	Range	Sales Pkg Qty	Part No.
12	340	200	★★★	1	E-11324
12	540	400	★★★★	1	E-11330
14	340	200	★★★	1	E-11346
14	540	400	★★★	1	E-11352
16	340	200	★★★	1	E-11368
16	540	400	★★★★	1	E-11374
18	340	200	★★★	1	E-11380
18	540	400	★★★	1	E-11396
20	340	220	★★★	1	E-11405
20	540	420	★★★★	1	E-11411
22	340	220	★★★	1	E-11427
22	540	420	★★★★	1	E-11433
24	340	220	★★★	1	E-11449
24	540	420	★★★★	1	E-11455
25	340	220	★★★	1	E-11461
25	540	420	★★★★	1	E-11477
28	370	250	★★★	1	E-11483
28	570	450	★★★★	1	E-11499
30	370	250	★★★	1	E-11508
30	570	450	★★★	1	E-11514

**TCT drill bit for SDS-MAX hammers Nemesis**



Bit dia mm	Length mm	Working Length mm	Range	Sales Pkg Qty	Part No.
12	340	200	★★★★	1	B-19897
12	540	400	★★★★	1	B-19906
12	740	600	★★★★	1	B-19912
14	340	200	★★★★	1	B-19928
14	540	400	★★★★	1	B-19934
15	340	200	★★★★	1	B-19940
15	540	400	★★★★	1	B-19956
16	340	200	★★★★	1	B-19962
16	540	400	★★★★	1	B-19978
16	940	800	★★★★	1	B-19984
18	340	200	★★★★	1	B-19990
18	540	400	★★★★	1	B-20002
18	940	800	★★★★	1	B-20018
20	320	200	★★★★	1	B-20024
20	520	400	★★★★	1	B-20030
20	920	800	★★★★	1	B-20046
22	320	200	★★★★	1	B-20052
22	520	400	★★★★	1	B-20068
22	920	800	★★★★	1	B-20074
24	320	200	★★★★	1	B-20080
24	520	400	★★★★	1	B-20096
25	320	200	★★★★	1	B-20105
25	520	400	★★★★	1	B-20111
25	920	800	★★★★	1	B-20127
26	520	400	★★★★	1	B-20133
28	370	250	★★★★	1	B-20149
28	570	450	★★★★	1	B-20155
28	670	550	★★★★	1	B-20161
28	920	800	★★★★	1	B-20177
30	370	250	★★★★	1	B-20183
30	570	450	★★★★	1	B-20199
32	370	250	★★★★	1	B-20208
32	570	450	★★★★	1	B-20214
32	920	800	★★★★	1	B-20220
35	370	250	★★★★	1	B-20236
35	570	450	★★★★	1	B-20242
35	670	550	★★★★	1	B-20258
35	920	800	★★★★	1	B-20264
38	370	250	★★★★	1	B-20270
38	570	450	★★★★	1	B-20286
40	370	250	★★★★	1	B-20292
40	570	450	★★★★	1	B-20301
40	920	800	★★★★	1	B-20317
45	570	450	★★★★	1	B-20323
50	570	450	★★★★	1	B-42896
52	570	450	★★★★	1	B-20339

**TCT drill bit for SDS-MAX hammers Mining**

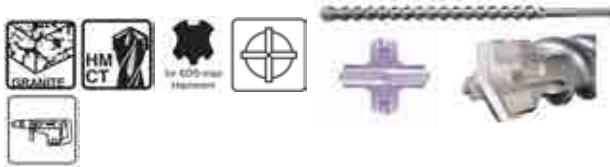

Bit dia mm	Length mm	Working Length mm	Range	Sales Pkg Qty	Part No.
28	670	550	Specialized	1	B-15039
28	920	800	Specialized	1	B-18035
28	1320	1200	Specialized	1	B-18041
30	720	600	Specialized	1	B-19847
30	920	800	Specialized	1	B-19853
32	570	450	Specialized	1	B-14613
32	920	800	Specialized	1	B-15045
32	1320	1200	Specialized	1	B-18057
40	370	250	Specialized	1	B-18079

**TCT drill bit for SDS-MAX hammers Mining 2**



Bit dia mm	Length mm	Working Length mm	Range	Sales Pkg Qty	Part No.
28	670	550	Specialized	1	B-39431
30	720	600	Specialized	1	B-39447
32	570	450	Specialized	1	B-39453
32	920	800	Specialized	1	B-39469

**TCT drill bit for SDS-MAX hammers Dustless**



Bit dia mm	Length mm	Working Length mm	Range	Sales Pkg Qty	Part No.
16	600	400	Specialized	1	B-64428
18	600	400	Specialized	1	B-64434
20	600	400	Specialized	1	B-64440
22	600	400	Specialized	1	B-64456
24	600	400	Specialized	1	B-64462
25	600	400	Specialized	1	B-64478
28	600	400	Specialized	1	B-64484
28	900	700	Specialized	1	B-64490
30	600	400	Specialized	1	B-64509
30	900	700	Specialized	1	B-64515
32	600	400	Specialized	1	B-64521
32	900	700	Specialized	1	B-64537
35	600	400	Specialized	1	B-64543
35	900	700	Specialized	1	B-64559

**TCT drill bit for 17mm Hex shank hammers**



Bit dia mm	Length mm	Range	Sales Pkg Qty	Part No.
16	280	★★	1	D-20127
16	505	★★	1	D-20133
18	280	★★	1	D-20149
18	505	★★	1	D-20155
19	280	★★	1	D-20161
19	505	★★	1	D-20177
20	280	★★	1	D-20183
20	505	★★	1	D-20199
22	280	★★	1	D-20208
22	505	★★	1	D-20214
25.5	280	★★	1	D-20220
25.5	505	★★	1	D-20236
28	280	★★	1	D-20242
28	505	★★	1	D-20258
32	280	★★	1	D-20264
32	505	★★	1	D-20270
35	280	★★	1	D-20286
35	505	★★	1	D-20292

**Core bit for SDS-PLUS hammers**



Bit dia mm	Length mm	Working Length mm	Note	Range	Sales Pkg Qty	Part No.	
8	110	60	Pilot drill	★★	1	D-73972	
30	72	50	Core only	★★	1	D-73891	
35	72	50		★★	1	D-73900	
40	72	50		★★	1	D-73916	
50	72	50		★★	1	D-73922	
68	72	50		★★	1	D-73938	
82	72	50		★★	1	D-73944	
90	72	50		★★	1	D-73950	
100	72	50		★★	1	D-73966	
68	175	50		Core, Adapter, Pilot drill set	★★	1	D-74011
82	175	50			★★	1	D-74027
-	110	-	SDS-PLUS shank adapter	★★	1	D-73988	
-	200	-		★★	1	D-73994	
-	350	-		★★	1	D-74005	









**Concrete core cutter for SDS-MAX hammers**



Bit dia mm	Length mm	Range	Sales Pkg Qty	Part No.
40	550	★★★★	1	B-57629
45	550	★★★★	1	B-57635
45	990	★★★★	1	B-57641
55	550	★★★★	1	B-57657
55	990	★★★★	1	B-57663
65	550	★★★★	1	B-57679
65	990	★★★★	1	B-57685
80	550	★★★★	1	B-57691
80	990	★★★★	1	B-57700

# Chisels



Shape	Application	For SDS-PLUS Hammers	For SDS-MAX Hammers	17mm Hex	19mm Hex	21mm Hex	28.6mm Hex	30mm Hex	Makita Small
<p>Bull point</p> 	Demolition and adjustment work in masonry and concrete. Chipping and breaking in masonry and concrete. Starts holes in concrete	●	●	●	●	●	●	●	●
<p>Cold chisel</p> 	Adjustment work in masonry and concrete. Chipping, breaking, edging and channeling in masonry and concrete.	●	●	●	●	●	●	●	
<p>Grooving chisel</p> 	Cutting channels in concrete.	●	●	●					
<p>Scaling chisel</p> 	Removing concrete residues.	●	●	●	●	●	●	●	●
<p>Clay spade</p> 	Digging in clay, hard gravel, hard packed gravel, soil and dirt.		●	●		●		●	
<p>Rammer</p> 	Tamping asphalt and compacting gravel, soil and dirt.		●	●	●	●		●	
<p>Bushing tool</p> 	Roughing concrete and asphalt up.		●	●		●			
<p>Scraper</p> 	Scraping floor tiles, linoleum floor and clean-up.	●							●

**Bull point for SDS-PLUS hammers**



Size mm	Range	Sales Pkg Qty	Part No.
140	★★	1	D-19152
160	★★	1	D-08034
230	★★	1	D-71249
250	★★★	1	B-64294
250	★★	1	D-08713
250	★★	1	D-62424
400	★★	1	D-19015

**Cold chisel for SDS-PLUS hammers**



Size mm	Range	Sales Pkg Qty	Part No.
20x140	★★	1	D-19168
20x160	★★	1	D-71255
20x230	★★	1	D-71261
20x250	★★★	1	B-64303
20x250	★★	1	D-08729
20x250	★★	1	D-62430
20x400	★★	1	D-19021

**Bull point for SDS-PLUS hammers Premium**



Size mm	Range	Sales Pkg Qty	Part No.
250	★★★★	1	B-64238

**Cold chisel for SDS-PLUS hammers Premium**



Size mm	Range	Sales Pkg Qty	Part No.
20x250	★★★★	1	B-64244

**Bull point for SDS-PLUS hammers Self-sharpening**



*Self sharpening*

**Feature**

Unique star-shape design keeps always sharp

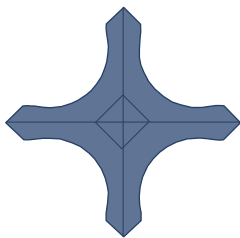

**Benefit**

- No re-sharpening necessary
- No work interruption due to resharping
- No service costs

Size mm	Range	Sales Pkg Qty	Part No.
250	★★★★	1	B-64761

**Cold chisel for SDS-PLUS hammers Self-sharpening**



*Self sharpening*

Size mm	Range	Sales Pkg Qty	Part No.
20x250	★★★★	1	B-64777

**Scaling chisel for SDS-PLUS hammers**



Size mm	Range	Sales Pkg Qty	Part No.
40x230	★★	1	D-71277
40x250	★★★	1	B-64319
40x250	★★	1	D-08735
50x215	★★	1	D-25616
50x215	★★	1	D-62446
80x150	★★	1	D-61042
80x250	★★	1	D-61020

**Scaling chisel for SDS-PLUS hammers Premium**



Size mm	Range	Sales Pkg Qty	Part No.
40x250	★★★★	1	B-64250

**Scaling chisel for SDS-PLUS hammers Self-sharpening**

*Self sharpening*



Size mm	Range	Sales Pkg Qty	Part No.
40x250	★★★★	1	B-14059
60x250	★★★★	1	B-14065

**Scaling chisel for SDS-PLUS hammers Tile**



Size mm	Range	Sales Pkg Qty	Part No.
40x260	★★★	1	B-14071

**Grooving chisel for SDS-PLUS hammers**



Size mm	Range	Sales Pkg Qty	Part No.
8x170	★★★	1	A-30075

**Scraper Assembly for SDS-PLUS hammers**



Size mm	Range	Sales Pkg Qty	Part No.
100x160	Specialized	1	A-68161

**Chisel for SDS-PLUS hammers assortment set in plastic case**



Size mm	Range	Sales Pkg Qty	Part No.
Bull 230, Cold 20x230, Scaling 40x230	★★	3	D-71314
Bull 250, Cold 20x250, Scaling 40x250	★★	3	D-30134

**Chisel for SDS-PLUS hammers assortment set in aluminum case**



Size mm	Range	Sales Pkg Qty	Part No.
Bull 250, Cold 20x250, Scaling 40x250	★★	3	D-05181
Bull 250, Cold 20x250	★★	4	D-08757
Bull 250, Cold 20x250, Scaling 40x250	★★	5	D-16368

**Chisel for SDS-PLUS hammers assortment set in aluminum case with Makita blue**



Size mm	Range	Sales Pkg Qty	Part No.
Bull 250, Cold 20x250, Scaling 40x250	★★	3	D-42357
Bull 250, Cold 20x250	★★	4	D-42363
Bull 250, Cold 20x250, Scaling 40x250	★★	5	D-42379

**Chisel for SDS-PLUS hammers Premium assortment set in plastic case**



Size mm	Range	Sales Pkg Qty	Part No.
Bull 250, Cold 20x250, Scaling 40x250	★★★★	3	E-04911

### Bull point for SDS-MAX hammers



Size mm	Range	Sales Pkg Qty	Part No.
280	★★★★	1	A-80787
280	★★★★	1	B-13823
300	★★	1	D-34176
400	★★★★	1	A-80793
400	★★★★	1	B-13839
400	★★★★	1	B-64325
400	★★	1	D-34182
400	★★	10	D-34182-10
600	★★★★	1	B-13845
600	★★	1	D-34198

### Bull point for SDS-MAX hammers Premium



Size mm	Range	Sales Pkg Qty	Part No.
400	★★★★	1	B-64266

### Bull point for SDS-MAX hammers Self-sharpening

*Self sharpening*



Size mm	Range	Sales Pkg Qty	Part No.
400	★★★★	1	B-10366
400	★★★★	1	B-10621
400	★★★★	1	B-23064

### Cold chisel for SDS-MAX hammers



Size mm	Range	Sales Pkg Qty	Part No.
25x280	★★★	1	A-80802
25x280	★★★	1	B-13851
25x300	★★	1	D-34207
25x400	★★★★	1	A-80818
25x400	★★★★	1	B-13867
25x400	★★★★	1	B-64331
25x400	★★	1	D-34213
25x400	★★	10	D-34213-10
25x600	★★★★	1	B-13873
25x600	★★	1	D-34229

### Cold chisel for SDS-MAX hammers Premium



Size mm	Range	Sales Pkg Qty	Part No.
25x400	★★★★	1	B-64272

### Cold chisel for SDS-MAX hammers Self-sharpening

*Self sharpening*



Size mm	Range	Sales Pkg Qty	Part No.
25x400	★★★★	1	B-64783

### Scaling chisel for SDS-MAX hammers



Size mm	Range	Sales Pkg Qty	Part No.
50x400	★★★	1	A-80824
50x400	★★★★	1	B-13889
50x400	★★★	1	B-64347
50x400	★★	1	D-34235
80x300	★★★	1	B-13895
80x300	★★	1	D-34241
115x350	★★★	1	B-13910

### Scaling chisel for SDS-MAX hammers Premium



Size mm	Range	Sales Pkg Qty	Part No.
50x380	★★★★	1	B-64288

### Scaling chisel for SDS-MAX hammers Self-sharpening

*Self sharpening*



Size mm	Range	Sales Pkg Qty	Part No.
50x350	★★★	1	B-14015

**Scaling chisel for SDS-MAX hammers Tile**



Size mm	Range	Sales Pkg Qty	Part No.
50x300	★★★	1	A-80830
50x300	★★★★	1	B-14021

**Grooving chisel for SDS-MAX hammers**



Size mm	Range	Sales Pkg Qty	Part No.
26x300	Specialized	1	B-13926

**Clay spade for SDS-MAX hammers**



Size mm	Range	Sales Pkg Qty	Part No.
110x400	Specialized	1	B-13976

**Rammer for SDS-MAX hammers**



Size mm	Note	Range	Sales Pkg Qty	Part No.
140	Use with shank adapter(A-19897)	Specialized	1	A-19875

**Bushing tool for SDS-MAX hammers**



Size mm	Note	Range	Sales Pkg Qty	Part No.
60x60	Use with shank adapter(A-19897)	Specialized	1	A-19881

**Shank adapter for SDS-MAX hammers**



Size mm	Note	Range	Sales Pkg Qty	Part No.
250	Shank for A-19881, A-19875	Specialized	1	A-19897

**Chisel for SDS-MAX hammers assortment set in cardboard box**



Size mm	Range	Sales Pkg Qty	Part No.
Bull 400, Cold 25x400	★★	10	D-35324-10

**Chisel for SDS-MAX hammers assortment set in aluminum case**



Size mm	Range	Sales Pkg Qty	Part No.
Bull 400, Cold 25x400, Scaling 50x400	★★	3	D-40543
Bull 300, 400, Cold 25x300, 25x400	★★	4	D-40559
Bull 400, Cold 25x400	★★	5	D-40618
Bull 400, Cold 25x400, Scaling 50x400, 80x300	★★	6	D-40565

**Chisel for SDS-MAX hammers assortment set in aluminum case with Makita blue**



Size mm	Range	Sales Pkg Qty	Part No.
Bull 400, Cold 25x400, Scaling 50x400	★★	3	D-42450
Bull 300, 400, Cold 25x400, 25x300	★★	4	D-42466
Bull 400, Cold 25x400	★★	5	D-42472
Bull 400, Cold 25x400, Scaling 50x400, 80x300	★★	6	D-42488

**Chisel for SDS-MAX hammers Premium assortment set in plastic case**



Size mm	Range	Sales Pkg Qty	Part No.
Bull 400, Cold 25x400, Scaling 50x380	★★★★	5	E-04927

### Bull point for 17mm Hex shank hammers



Size mm	Range	Sales Pkg Qty	Part No.
210	★★	1	D-16374
255	★★	1	D-71283
280	★★★	1	A-80450
280	★★	1	D-08682
280	★★	1	D-26303
350	★★	1	D-29860
450	★★★	1	A-80547
450	★★	1	D-16863

### Cold chisel for 17mm Hex shank hammers



Size mm	Range	Sales Pkg Qty	Part No.
19x210	★★	1	D-26587
19x280	★★★	1	A-80569
19x280	★★	1	D-08707
19x450	★★★	1	A-80575
19x450	★★	1	D-16879
22x255	★★	1	D-71299

### Scaling chisel for 17mm Hex shank hammers



Size mm	Range	Sales Pkg Qty	Part No.
40x255	★★	1	D-71308
50x280	★★★	1	A-80606
50x280	★★	1	D-20694
50x450	★★	1	D-52548

### Grooving chisel for 17mm Hex shank hammers



Size mm	Range	Sales Pkg Qty	Part No.
22x280	★★★	1	A-48555
26x280	★★★	1	A-48561

### Clay spade for 17mm Hex shank hammers



Size mm	Range	Sales Pkg Qty	Part No.
105x400	Specialized	1	A-25214

### Rammer for 17mm Hex shank hammers



Size mm	Range	Sales Pkg Qty	Part No.
140	Specialized	1	A-21428

### Bushing tool for 17mm Hex shank hammers



Size mm	Range	Sales Pkg Qty	Part No.
60x60	Specialized	1	A-21484

### Ground rod adapter for 17mm Hex shank hammers



Size mm	Range	Sales Pkg Qty	Part No.
180	Specialized	1	A-47276

### Chisel for 17mm Hex shank hammers assortment set in plastic case



Size mm	Range	Sales Pkg Qty	Part No.
Bull 255, Cold 22x255, Scaling 40x255	★★	3	D-71320

### Bull point for 19mm Hex shank hammers



Size mm	Range	Sales Pkg Qty	Part No.
300	★★	1	D-20074
450	★★	1	D-19196

### Cold chisel for 19mm Hex shank hammers

Adjustment work in masonry and concrete: Chipping, breaking, edging and channeling in masonry and concrete



Size mm	Range	Sales Pkg Qty	Part No.
26x300	★★	1	D-20080
26x450	★★	1	D-19205

### Scaling chisel for 19mm Hex shank hammers



Size mm	Range	Sales Pkg Qty	Part No.
50x300	★★	1	D-20096

### Rammer for 19mm Hex shank hammers



Size mm	Range	Sales Pkg Qty	Part No.
140	Specialized	1	A-21478

### Ground rod adapter for 19mm Hex shank hammers



Size mm	Range	Sales Pkg Qty	Part No.
20x180	Specialized	1	798132-2

### Bull point for 21mm Hex shank hammers



Size mm	Range	Sales Pkg Qty	Part No.
320	★★	1	D-16499
450	★★★	1	A-80553
450	★★	1	D-23824
600	★★	1	D-30994

### Cold chisel for 21mm Hex shank hammers



Size mm	Range	Sales Pkg Qty	Part No.
26x320	★★	1	D-17588
26x450	★★★	1	A-80581
26x450	★★	1	D-17594

### Scaling chisel for 21mm Hex shank hammers

For removing concrete residues



Size mm	Range	Sales Pkg Qty	Part No.
70x320	★★	1	D-20672

### Clay spade for 21mm Hex shank hammers



Size mm	Range	Sales Pkg Qty	Part No.
130x460	Specialized	1	A-47391

### Rammer for 21mm Hex shank hammers



Size mm	Range	Sales Pkg Qty	Part No.
140	Specialized	1	A-21434

### Bushing tool for 21mm Hex shank hammers



Size mm	Range	Sales Pkg Qty	Part No.
60x60	Specialized	1	A-21490

### Bull point for 28.6mm Hex shank hammers



Size mm	Range	Sales Pkg Qty	Part No.
350	★★	1	D-65034
410	★★	1	D-17631
410	★★★	1	D-61531
520	★★	1	D-17675
520	★★	1	D-61569

### Bull point for 28.6mm Hex shank hammers Self-sharpening

*Self sharpening*



Size mm	Range	Sales Pkg Qty	Part No.
400	★★★★	1	B-10372

### Cold chisel for 28.6mm Hex shank hammers



Size mm	Range	Sales Pkg Qty	Part No.
28x410	★★	1	D-17647
28x410	★★	1	D-61547
28x520	★★	1	D-17681
28x520	★★	1	D-61575

### Scaling chisel for 28.6mm Hex shank hammers



Size mm	Range	Sales Pkg Qty	Part No.
75x410	★★	1	D-29228
75x410	★★	1	D-61553
75x520	★★	1	D-20725
75x520	★★	1	D-61581

### Bull point for 30mm Hex shank hammers



Size mm	Range	Sales Pkg Qty	Part No.
400	★★	1	D-15285
410	★★★	1	A-80466

### Bull point for 30mm Hex shank hammers Self-sharpening

*Self sharpening*



Size mm	Range	Sales Pkg Qty	Part No.
400	★★★★	1	B-10388

### Cold chisel for 30mm Hex shank hammers



Size mm	Range	Sales Pkg Qty	Part No.
30x400	★★	1	D-15300
36x410	★★★	1	A-80597

### Scaling chisel for 30mm Hex shank hammers



Size mm	Range	Sales Pkg Qty	Part No.
75x310	★★	1	D-23868
75x310	★★	1	D-34805

### Clay spade for 30mm Hex shank hammers



Size mm	Range	Sales Pkg Qty	Part No.
120x500	Specialized	1	B-10300

**Rammer for 30mm Hex shank hammers**



Size mm	Range	Sales Pkg Qty	Part No.
200	Specialized	1	A-31485

**Bull point for Makita small shank**



Size mm	Length mm	Range	Sales Pkg Qty	Part No.
220	220	★★★	1	B-06921

**Scaling chisel for Makita small shank**



Size mm	Length mm	Range	Sales Pkg Qty	Part No.
20x220	220	★★★	1	B-07004
30x150	150	★★★	1	B-07331
50x150	150	★★★	1	B-07347
50x220	220	★★★	1	B-07010

**Scraper Assembly for Makita small shank**



Size mm	Range	Sales Pkg Qty	Part No.
100x160	Specialized	1	A-68155

**TCT drill bit & chisel for SDS-PLUS hammers assortment set in plastic case**



Size mm	Range	Sales Pkg Qty	Part No.
Drill 5 to 8, Bull 250, Cold 20x250, Scaling 40x250	★★	6	D-58920
Drill 5 to 16, Bull 160, Cold 20x140	★★	10	D-46361
Drill 5 to 16, Bull 160, Cold 20x140	★★	10	D-57059
Drill 5.5 to 15, Bull 160, Cold 20x140	★★	10	D-44971
Drill 6 to 18, Bull 160, Cold 20x140	★★	10	D-41470

**TCT drill bit & chisel for SDS-PLUS hammers assortment set in aluminum case**



Size mm	Range	Sales Pkg Qty	Part No.
Drill 5.5 to 20, Bull 250, Cold 20x250	★★	10	D-21191
Drill 6 to 20, Bull 250, Cold 20x250	★★	10	D-19174
Drill 5 to 16, Bull 250, Cold 20x250	★★	13	D-20111
Drill 5 to 16, Bull 250, Cold 20x250	★★	13	D-21185
Drill 5 to 14, Bull 140, 250, Cold 20x250, 20x140, Scaling 40x250	★★	17	D-19180
Drill 5 to 14, Bull 140, 250, Cold 20x250, 20x140, Scaling 40x250	★★	17	D-21200

**TCT drill bit & chisel for SDS-PLUS hammers assortment set in aluminum case with Makita blue**



Size mm	Range	Sales Pkg Qty	Part No.
Drill 5 to 16, Bull 250, Cold 20x250	★★	10	D-71990
Drill 6 to 20, Bull 250, Cold 20x250	★★	10	D-42385
Drill 5.5 to 16, Bull 250, Cold 20x250	★★	10	D-70904
Drill 5.5 to 20, Bull 250, Cold 20x250	★★	10	D-42391
Drill 5 to 16, Bull 250, Cold 20x250	★★	13	D-42400
Drill 5 to 16, Bull 250, Cold 20x250	★★	13	D-42416
Drill 6 to 16, Bull 250, Cold 20x250	★★★	13	B-64674
Drill 5 to 16, Bull 250, Cold 20x250	★★	14	D-71174
Drill 5 to 14, Bull 140, 250, Cold 20x140, 20x250, Scaling 40x250	★★★	17	E-03115
Drill 5 to 14, Bull 140, 250, Cold 20x250, 20x140, Scaling 40x250	★★	17	D-42438
Drill 5 to 14, Bull 140, 250, Cold 20x250, 20x140, Scaling 40x250	★★	17	D-42444
Drill 6 to 14, Bull 140, 250, Cold 20x140, 20x250, Scaling 40x250	★★★	17	B-64680
Drill 4 to 14.3, Bull 140, 250, Cold 20x250, 20x140, Scaling 40x250	★★	17	D-61008
Drill 5 to 12, Bull 140, 250, Cold 20x140, 20x250, Scaling 40x250	★★	18	D-71180
Drill 5 to 14, Bull 140, 250, Cold 20x140, 20x250, Scaling 40x250	★★	18	D-71196

### TCT drill bit & chisel for SDS-PLUS hammers assortment set in roll up pouch

Compact and easy to carry with you



Size mm	Range	Sales Pkg Qty	Part No.
Drill 5 to 16, Bull 250, Cold 20x250	★★	13	D-53659
Drill 5.5 to 16, Bull 250, Cold 20x250	★★	13	D-70895
Drill 4 to 16, Bull 140, 250, Cold 20x140, 20x250, Scaling 40x250	★★	17	D-53300
Drill 4 to 16, Bull 140, 250, Cold 20x140, 20x250, Scaling 40x250	★★	17	D-53609
Drill 5 to 14, Bull 140, 250, Cold 20x140, 20x250, Scaling 40x250	★★	17	D-53073
Drill 5 to 14, Bull 140, 250, Cold 20x140, 20x250, Scaling 40x250	★★	17	D-53621
Drill 5 to 14, Bull 140, 250, Cold 20x140, 20x250, Scaling 40x250	★★	17	D-54863

### TCT drill bit & chisel for SDS-PLUS hammers assortment set in MAKPAC



Size mm	Range	Sales Pkg Qty	Part No.
Drill 5 to 14, Bull 140, 250, Cold 20x250, 20x140, Scaling 40x250	★★	17	B-52059
Drill 5 to 14, Bull 140, 250, Cold 20x250, 20x140, Scaling 40x250	★★	17	B-53877

### TCT drill bit & chisel for SDS-MAX hammers assortment set in aluminum case



Size mm	Range	Sales Pkg Qty	Part No.
Drill 18 to 25, Bull 400, Cold 25x400, Scaling 50x400	★★	7	D-40571

### TCT drill bit & chisel for SDS-MAX hammers assortment set in aluminum case with Makita blue



Size mm	Range	Sales Pkg Qty	Part No.
Drill 18 to 25, Bull 400, Cold 25x400, Scaling 50x400	★★	7	D-42494

### Chuck adapter for SDS-PLUS hammers



Size mm	Length mm	Range	Sales Pkg Qty	Part No.
M6x22	64	★★★	1	D-14093

# ACCESSORIES

## Fastening



*Impact*  
**PREMIER**



1/4inch Hex shank



6.35hex shank C form



6.35hex shank MZ



6.35hex shank NZ



Magnet



For SDS-PLUS Hammers



1/2inch SQ



CR-MO

# Accessories

## Fastener drive and screwdriving series

### 1. C-form



### 2. E-form



### 3. Double-end

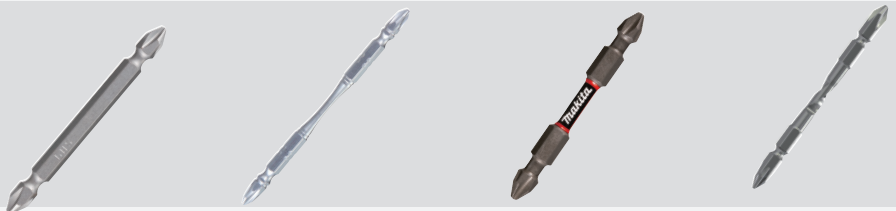

### 4. Bit holder



### 5. Nutsetter



### 6. Bit Set



### 7. Socket adapter / Socket bit



### 8. Impact socket



### 9. Other

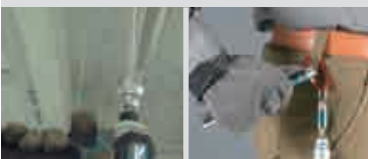

# Impact PREMIER

*Double Torsion  
for High Durability.*



*New Steel  
is Used.  
Supports High Torque.*

*High Precision  
Screw Fitting.*

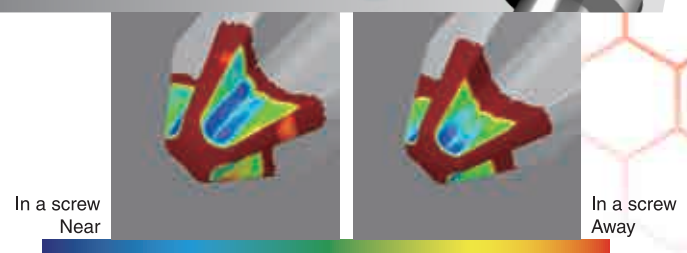

Impact  
PREMIER

STANDARD

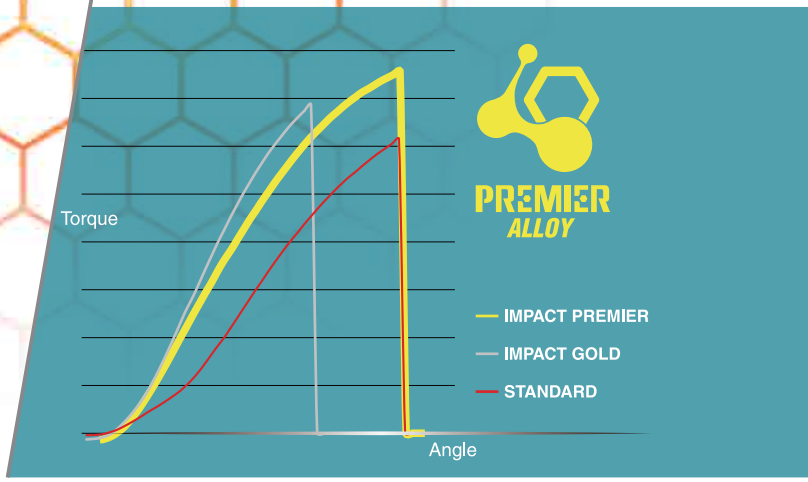

# NEW INNOVATION

### Torsion screw bit C-form Impact PREMIER



Shank Type	Bit type	Length mm	Range	Sales Pkg Qty	Part No.
C-form	PH 1	25	★★★★★	2	E-03121
	PH 2	25	★★★★★	2	E-03137
	PH 2	25	★★★★★	15	E-03246
	PH 2R	25	★★★★★	2	E-03143
	PH 3	25	★★★★★	2	E-03159
	PZ 1	25	★★★★★	2	E-03165
	PZ 2	25	★★★★★	2	E-03171
	PZ 2	25	★★★★★	15	E-03252
	PZ 3	25	★★★★★	2	E-03187
	T 10	25	★★★★★	2	E-03193
	T 15	25	★★★★★	2	E-03202
	T 20	25	★★★★★	2	E-03218
	T 25	25	★★★★★	2	E-03224
	T 30	25	★★★★★	2	E-03230

### Torsion bit holder E-form Impact PREMIER



Shank Type	Length mm	Range	Sales Pkg Qty	Part No.
E-form (MZ)	68	★★★★★	1	E-03399
E-form (MZ)	150	★★★★★	1	E-03408

### Ultra mag torsion bit holder E-form Impact PREMIER



Shank Type	Length mm	Range	Sales Pkg Qty	Part No.
E-form (MZ)	79	★★★★★	1	E-03414

### Torsion screw bit E-form Impact PREMIER



Shank Type	Bit type	Length mm	Range	Sales Pkg Qty	Part No.
E-form (MZ)	PH 1	50	★★★★★	2	E-03268
	PH 2	50	★★★★★	2	E-03274
	PH 2	50	★★★★★	10	E-03377
	PH 3	50	★★★★★	2	E-03280
	PZ 1	50	★★★★★	2	E-03296
	PZ 2	50	★★★★★	2	E-03305
	PZ 2	50	★★★★★	10	E-03383
	PZ 3	50	★★★★★	2	E-03311
	T 10	50	★★★★★	2	E-03327
	T 15	50	★★★★★	2	E-03333
	T 20	50	★★★★★	2	E-03349
	T 25	50	★★★★★	2	E-03355
	T 30	50	★★★★★	2	E-03361
	T 40	50	★★★★★	2	E-12027

### Torsion nutsetter E-form Impact PREMIER



Shank Type	Socket Size mm	Length mm	Range	Sales Pkg Qty	Part No.
E-form (MZ)	6	65	★★★★★	1	E-03458
	8	65	★★★★★	1	E-03464
	10	65	★★★★★	1	E-03470
	13	65	★★★★★	1	E-03486

### Double ended torsion screw bit E-form Impact PREMIER



Shank Type	Bit type	Length mm	Range	Sales Pkg Qty	Part No.
E-form (MZ)	PH 2	65	★★★★★	2	E-06286
	PZ 2	65	★★★★★	2	E-06292

### Tilt socket adapter E-form Impact PREMIER



Shank Type	Bit type	Length mm	Range	Sales Pkg Qty	Part No.
E-form (MZ)	3/8 inch Drive	50	★★★★★	1	E-03420
	1/2 inch Drive	50	★★★★★	1	E-03436

**Tilt socket bit E-form Impact PREMIER**



Shank Type	Socket Size mm	Length mm	Range	Sales Pkg Qty	Part No.
E-form (MZ)	13	75	★★★★★	1	E-03492
	15	75	★★★★★	1	E-03501
	17	75	★★★★★	1	E-03517
	19	75	★★★★★	1	E-03523
	21	80	★★★★★	1	E-03539

**Mag boost Impact PREMIER**



Range	Sales Pkg Qty	Part No.
★★★★★	1	E-03442

**Torsion screw bit C-form Impact PREMIER with bit holder Assortment**



Shank Type	Range	Sales Pkg Qty	Part No.
C-form & E-form (MZ)	★★★★★	11	E-03567
	★★★★★	11	E-03573

**Torsion screw bit E-form**



Shank Type	Bit type	Length mm	Range	Sales Pkg Qty	Part No.
E-form (NZ)	PH 1	65	★★★★★	3	A-57451
	PH 1	100	★★★★★	3	A-57467
	PH 2	65	★★★★★	3	A-57473
	PH 2	65	★★★★★	6	A-57510
	PH 2	85	★★★★★	3	A-57489
	PH 2	85	★★★★★	6	A-57526
	PH 2	100	★★★★★	3	A-57495
	PH 2	100	★★★★★	6	A-57532
	PH 2	120	★★★★★	3	A-57504
	PH 2	120	★★★★★	6	A-57445

**Double ended torsion screw bit E-form Twist**



Shank Type	Bit type	Length mm	Range	Sales Pkg Qty	Part No.
E-form (NZ)	PH 2	90	★★★★★	3	A-59570
	PH 2	90	★★★★★	3	A-59601
	PH 2	120	★★★★★	3	A-59586
	PH 2	120	★★★★★	3	A-59617
	PH 2	150	★★★★★	3	A-59592
	PH 2	150	★★★★★	3	A-59623

**Double ended torsion screw bit E-form**

Torsion section flexes under load and takes pressure off bit tip



Shank Type	Bit type	Length mm	Range	Sales Pkg Qty	Part No.
E-form (MZ)	PH 1	65	★★★★★	3	B-21836
	PH 1	85	★★★★★	3	B-21842
	PH 1	110	★★★★★	3	B-21858
	PH 2	65	★★★★★	3	B-20703
	PH 2	85	★★★★★	3	B-12326
	PH 2	110	★★★★★	3	B-21864
	PH 3	65	★★★★★	3	B-21870
	PH 3	85	★★★★★	3	B-21886
	PH 3	110	★★★★★	3	B-21892
	PZ 1	65	★★★★★	3	B-21901
	PZ 1	85	★★★★★	3	B-21917
	PZ 1	110	★★★★★	3	B-21923
	PZ 2	65	★★★★★	3	B-20719
	PZ 2	85	★★★★★	3	B-12790
	PZ 2	85	★★★★★	18	B-16259
	PZ 2	110	★★★★★	3	B-21939
	PZ 3	65	★★★★★	3	B-20725
	PZ 3	85	★★★★★	3	B-20731
PZ 3	110	★★★★★	3	B-21945	
E-form (NZ)	PH 1	65	★★★★★	3	A-52881
	PH 1	110	★★★★★	3	A-52897
	PH 2	65	★★★★★	3	A-49563
	PH 2	65	★★★★★	3	A-50924
	PH 2	65	★★★★★	3	B-55376
	PH 2	65	★★★★★	6	A-49579
	PH 2	85	★★★★★	3	A-49585
	PH 2	85	★★★★★	3	A-50952
	PH 2	110	★★★★★	3	A-49600
	PH 2	110	★★★★★	3	A-50980
	PH 2	110	★★★★★	10	B-52037
	PH 2	150	★★★★★	3	A-50120
	PH 3	65	★★★★★	3	A-52906
	PH 3	110	★★★★★	3	A-52912

## Screw bit C-form Impact BLACK



Shank Type	Bit type	Length mm	Range	Sales Pkg Qty	Part No.
C-form	PH 1	25	★★★	2	B-63600
	PH 2	25	★★★	2	B-63616
	PH 2	25	★★★	25	E-12360
				25x12sets	E-12360-12
	PH 3	25	★★★	2	B-63622
	PZ 1	25	★★★	2	B-63638
	PZ 2	25	★★★	2	B-63644
	PZ 2	25	★★★	25	E-12376
				25x12sets	E-12376-12
	PZ 3	25	★★★	2	B-63650
	T 15	25	★★★	2	B-63666
	T 20	25	★★★	2	B-63672
	T 20	25	★★★	25	E-12382
				25x12sets	E-12382-12
	T 25	25	★★★	2	B-63688
	T 25	25	★★★	25	E-12398
				25x12sets	E-12398-12
	T 30	25	★★★	2	B-63694
	T 30	25	★★★	25	E-12653
				25x12sets	E-12653-12
T 40	25	★★★	2	B-63703	
T 40	25	★★★	25	E-12669	
			25x12sets	E-12669-12	

## Screw bit E-form Impact BLACK



Shank Type	Bit type	Length mm	Range	Sales Pkg Qty	Part No.
E-form (MZ)	PH 1	50	★★★	2	B-63719
	PH 2	50	★★★	2	B-63725
	PH 2	50	★★★	10	E-12407
				10x12sets	E-12407-12
	PH 3	50	★★★	2	B-63731
	PZ 1	50	★★★	2	B-63747
	PZ 2	50	★★★	2	B-63753
	PZ 2	50	★★★	10	E-12413
				10x12sets	E-12413-12
	PZ 3	50	★★★	2	B-63769
	T 15	50	★★★	2	B-63775
	T 20	50	★★★	2	B-63781
	T 20	50	★★★	10	E-12429
				10x12sets	E-12429-12
	T 25	50	★★★	2	B-63797
	T 25	50	★★★	10	E-12435
				10x12sets	E-12435-12
	T 30	50	★★★	2	B-63806
	T 30	50	★★★	10	E-12675
				10x12sets	E-12675-12
T 40	50	★★★	2	B-63812	
T 40	50	★★★	10	E-12681	
			10x12sets	E-12681-12	
E-form (NZ)	PH 2	50	★★★	2	E-08763
	PH 3	50	★★★	2	E-08779

## Screw bit E-form Impact BLACK Assortment



Shank Type	Length mm	Range	Sales Pkg Qty	Part No.
E-form (MZ)	50	★★★	10	E-12011

## Magnetic bit holder E-form Impact BLACK



Shank Type	Length mm	Range	Sales Pkg Qty	Part No.
E-form (MZ)	60	★★★	1	B-66793
E-form (NZ)	60	★★★	1	E-08785

## Sleeve chuck bit holder E-form Impact BLACK



Shank Type	Length mm	Range	Sales Pkg Qty	Part No.
E-form (MZ)	60	★★★	1	B-66802
E-form (NZ)	60	★★★	1	E-08791

## Screw guide bit holder E-form Impact BLACK



Shank Type	Length mm	Range	Sales Pkg Qty	Part No.
E-form (MZ)	80	★★★	1	B-66818

**Nutsetter E-form Impact BLACK**



Shank Type	Socket Size mm	Length mm	Range	Sales Pkg Qty	Part No.
E-form (MZ)	6	50	★★★★	1	B-66824
	8	50	★★★★	1	B-66830
	10	50	★★★★	1	B-66846
	13	50	★★★★	1	B-66852
E-form (NZ)	6	50	★★★★	1	E-08800
	8	50	★★★★	1	E-08816
	10	50	★★★★	1	E-08822
	13	50	★★★★	1	E-08838

**Socket adapter E-form Impact BLACK**



Shank Type	Bit type	Length mm	Range	Sales Pkg Qty	Part No.
E-form (MZ)	3/8 inch Drive	50	★★★★	1	B-66868
	1/2 inch Drive	50	★★★★	1	B-66874
E-form (NZ)	3/8 inch Drive	50	★★★★	1	E-08844
	1/2 inch Drive	50	★★★★	1	E-08850

**Screw bit C-form Impact BLACK with bit holder Assortment**



Shank Type	Range	Sales Pkg Qty	Part No.
C-form & E-form (MZ)	★★★	8	E-11994

**Screw bit C & E-form Impact BLACK Assortment**



Shank Type	Range	Sales Pkg Qty	Part No.
C-form & E-form (MZ)	★★★★	33	B-66896
	★★★★	35	B-66880
C-form & E-form (NZ)	★★★★	33	E-06622
	★★★★	35	E-06638
	★★★★	33x10sets	E-06622-10
	★★★★	35x10sets	E-06638-10

**Screw bit C & E-form Impact BLACK Assortment in clear case series**



Shank Type	Range	Sales Pkg Qty	Part No.
C-form & E-form (MZ)	★★★★	33x10sets	E-12441-10

**Screw bit C-form in blister**



Shank Type	Bit type	Length mm	Range	Sales Pkg Qty	Part No.
C-form	PH 1	25	★★	3	B-23450
	PH 2	25	★★	3	B-23466
	PH 3	25	★★	3	B-23472
	PZ 1	25	★★	3	B-23488
	PZ 2	25	★★	3	B-23494
	PZ 3	25	★★	3	B-23503
	T 8	25	★★	3	B-23581
	T 10	25	★★	3	B-23597
	T 15	25	★★	3	B-23606
	T 20	25	★★	3	B-23612
	T 25	25	★★	3	B-23628
	T 27	25	★★	3	B-23634
	T 30	25	★★	3	B-23640
	T 40	25	★★	3	B-23656
	SL 0.5x4.0	25	★★	3	B-23519
	SL 0.6x4.5	25	★★	3	B-23525
	SL 0.8x5.5	25	★★	3	B-23531
	H 1.5	25	★★	3	B-23662
	H 2.0	25	★★	3	B-23678
	H 2.5	25	★★	3	B-23684
	H 3.0	25	★★	3	B-23690
	H 4.0	25	★★	3	B-23709
	H 5.0	25	★★	3	B-23715
	H 6.0	25	★★	3	B-23721
	H 8.0	25	★★	3	B-23737

**Screw bit C-form in plastic case**



Shank Type	Bit type	Length mm	Range	Sales Pkg Qty	Part No.
C-form	PH 1	25	★★	25	B-24577
	PH 2	25	★★	25	B-24583
	PH 2	25	★★	100	B-24876
	PH 2	25	★★	250	B-62452
	PZ 1	25	★★	25	B-24608
	PZ 2	25	★★	25	B-24614
	PZ 2	25	★★	100	B-24882
	PZ 3	25	★★	25	B-24620
	T 15	25	★★	25	B-24636
	T 20	25	★★	25	B-24642
	T 25	25	★★	25	B-24658
	T 30	25	★★	25	B-24664

Fastening

### Screw bit C-form in plastic bag



Shank Type	Bit type	Length mm	Range	Sales Pkg Qty	Part No.
C-form	PH 2	25	★★	100	B-24957
	PZ 2	25	★★	100	B-24963

### Screw bit C-form Assortment



Shank Type	Length mm	Range	Sales Pkg Qty	Part No.
C-form	25	★★	3	B-24511
	25	★★	3	B-24527
	25	★★	3	B-24533
	25	★★	10	D-73287
	25	★★	10	D-73293

### Screw bit for screwdriver C-form



Shank Type	Bit type	Length mm	Range	Sales Pkg Qty	Part No.
C-form	PH 2	25	★★★	3	798398-4
	PH 3	25	★★★	3	798314-6

### Dry wall bit C-form



Shank Type	Bit type	Length mm	Range	Sales Pkg Qty	Part No.
C-form	PH 2	30	★★★	1	D-61690

### Screw bit E-form



Shank Type	Bit type	Length mm	Range	Sales Pkg Qty	Part No.
E-form (NZ)	SL 0.6x5.0	45	★★★	3	798301-5
	SL 1.0x6.35	45	★★★	3	798299-6
	SL 1.2x10.0	52	★★★	3	798303-1
	SL 1.2x8.0	70	★★★	3	798302-3

### Screw bit E-form in blister



Shank Type	Bit type	Length mm	Range	Sales Pkg Qty	Part No.
E-form (MZ)	PH 1	50	★★	3	B-25214
	PH 2	50	★★	3	B-25220
	PH 2	90	★★	1	B-57788
	PH 2	150	★★	1	B-57847
	PH 3	50	★★	3	B-25236
	PZ 1	50	★★	3	B-25242
	PZ 2	50	★★	3	B-25258
	PZ 2	90	★★	1	B-59885
	PZ 2	150	★★	1	B-59950
	PZ 3	50	★★	3	B-25264
	T 8	50	★★	3	B-25351
	T 9	50	★★	3	B-25367
	T 10	50	★★	3	B-25373
	T 15	50	★★	3	B-25389
	T 15	90	★★	1	B-59900
	T 15	150	★★	1	B-59972
	T 20	50	★★	3	B-25395
	T 20	90	★★	1	B-59916
	T 20	150	★★	1	B-59988
	T 25	50	★★	3	B-25404
	T 25	90	★★	1	B-59922
	T 25	150	★★	1	B-59994
	T 27	50	★★	3	B-25410
	T 30	50	★★	3	B-25426
	T 30	90	★★	1	B-59938
	T 30	150	★★	1	B-60006
	T 40	50	★★	3	B-25432
	SL 0.5x4.0	50	★★	3	B-25286
	SL 0.6x4.5	50	★★	3	B-25292
	SL 0.8x5.5	50	★★	3	B-25301
	H 3.0	50	★★	3	B-25448
	H 4.0	50	★★	3	B-25454
	H 5.0	50	★★	3	B-25460
	H 6.0	50	★★	3	B-25476

**Screw bit E-form in plastic case**



Shank Type	Bit type	Length mm	Range	Sales Pkg Qty	Part No.
E-form (MZ)	PH 1	50	★★	10	B-26238
	PH 2	50	★★	10	B-26244
	PH 2	50	★★	50	B-26490
	PH 2	50	★★	100	B-62468
	PH 3	50	★★	10	B-26250
	PZ 1	50	★★	10	B-26266
	PZ 2	50	★★	10	B-26272
	PZ 2	50	★★	50	B-26509
	PZ 3	50	★★	10	B-26288
	SQ 2	50	★★	100	D-34920
	T 15	50	★★	10	B-26294
	T 20	50	★★	10	B-26303
	T 25	50	★★	10	B-26319
	T 30	50	★★	10	B-26325

**Screw bit E-form in plastic bag**



Shank Type	Bit type	Length mm	Range	Sales Pkg Qty	Part No.
E-form (MZ)	PH 2	50	★★	50	B-26571
	PZ 2	50	★★	50	B-26587

**Screw bit E-form Assortment**



Shank Type	Length mm	Range	Sales Pkg Qty	Part No.
E-form (MZ)	50	★★	10	D-65028
	50	★★	10	D-65040
	50	★★	3	B-26179
	50	★★	3	B-26185
	50	★★	3	B-26191
E-form (NZ)	50	★★	10	D-67620

**Screw bit E-form Assortment in battery type case**



Shank Type	Length mm	Range	Sales Pkg Qty	Part No.
E-form (MZ)	50	★★	21	B-68323

**Screw bit for screwdriver E-form**



Shank Type	Bit type	Length mm	Range	Sales Pkg Qty	Part No.
E-form (NZ)	PH 2	122	★★★	5	A-45858
	PH 2	132	★★★	5	A-16536

**Dry wall bit E-form**



Shank Type	Bit type	Length mm	Range	Sales Pkg Qty	Part No.
E-form (MZ)	PH 2	40	★★★	1	B-60399

**Double ended screw bit E-form**



Shank Type	Bit type	Length mm	Range	Sales Pkg Qty	Part No.
E-form (MZ)	PH 1	65	★★★	10	D-65523
	PH 1	65	★★★	100	D-65517
	PH 2	65	★★★	10	D-34366
	PH 2	65	★★★	10	D-65078
	PH 2	65	★★★	100	D-31669
	PH 2	110	★★★	10	D-34849
	PZ 2	65	★★★	100	D-34914
E-form (NZ)	PH 2	45	★★★	3	798308-1
	PH 2	45	★★★	10	D-34827
	PH 2	65	★★★	3	798309-9
	PH 2	65	★★★	10	D-33679
	PH 2	65	★★★	100	D-31653
	PH 2	65	★★★	100	D-63959
	PH 2	110	★★★	3	798337-4
	PH 2	110	★★★	10	D-34833
	PH 2	150	★★★	3	798338-2
	PH 3	45	★★★	3	798310-4
	PH 3	65	★★★	3	798311-2
	PH 3	110	★★★	3	798339-0

**Double ended screw bit with 1/4inch Hex shank**



Shank Type	Bit type	Length mm	Range	Sales Pkg Qty	Part No.
1/4 Inch Hex	PH 2-SL 5	65	★★★	10	D-65545
	PH 2-SL 5	65	★★★	100	D-65539
	PH 2-SL 5	110	★★★	10	D-65551

### Magnetic bit holder for screwdriver E-form



Shank Type	Length mm	Range	Sales Pkg Qty	Part No.
E-form (MZ)	60	★★★	1	B-52445
	150	★★★	1	B-57750
	300	★★★	1	B-57766

### Sleeve chuck bit holder E-form



Shank Type	Length mm	Range	Sales Pkg Qty	Part No.
E-form (MZ)	60	★★	1	B-52467

### Sleeve chuck bit holder for SDS-PLUS Hammers



Shank Type	Length mm	Range	Sales Pkg Qty	Part No.
SDS-PLUS	80	★★★	1	B-57548

### Screw guide bit holder E-form



Shank Type	Length mm	Range	Sales Pkg Qty	Part No.
E-form (MZ)	80	★★	1	B-48751
	120	★★	1	B-48767
	120	★★	1	B-52934
E-form (NZ)	120	★★★	1	D-71037
	120	★★	1	D-71043

### Flexible bit holder with 1/4inch Hex shank



Shank Type	Length mm	Range	Sales Pkg Qty	Part No.
1/4 Inch Hex	190	★★★	1	A-86963
	200	★★★	1	B-29072
	300	★★★	1	B-29094

### Flexible bit holder E-form



Shank Type	Length mm	Range	Sales Pkg Qty	Part No.
E-form (MZ)	300	★★★★★	1	B-51867
E-form (NZ)	300	★★★★★	1	B-51851

### Nutsetter E-form



Shank Type	Socket Size mm (inch)	Length mm	Range	Sales Pkg Qty	Part No.
E-form (MZ)	5.5	50	★★	1	B-38685
	6	50	★★	1	B-38691
	7	50	★★	1	B-38700
	8	50	★★	1	B-38716
	8	50	★★	50	B-67773
	10	50	★★	1	B-38722
	10	50	★★	30	B-67789
	11	50	★★	1	B-61999
	12	50	★★	1	B-38738
	13	50	★★	1	B-38744
	17	50	★★	1	B-38750
	(1/4)	50	★★	1	B-38766
	(1/4)	50	★★	50	E-01856
	(1/4)	(6)	★★	1	B-57255
	(5/16)	50	★★	1	B-38772
	(5/16)	50	★★	50	E-01862
	(5/16)	(6)	★★	1	B-57261
	(3/8)	50	★★	1	B-38788
	(3/8)	50	★★	30	E-01878
	(3/8)	(6)	★★	1	B-57277
E-form (NZ)	8	50	★★	50	B-68345
	17	50	★★	1	D-72964

**Nutsetter C-form Assortment**



Shank Type	Socket Size mm	Length mm	Range	Sales Pkg Qty	Part No.
C-form	8,10,12,13	48	★★	4	B-57554

**Nutsetter E-form Assortment**



Shank Type	Socket Size mm (inch)	Length mm	Range	Sales Pkg Qty	Part No.
E-form	6,8,10,12,13	50	★★	5	B-39154
(MZ)	(1/4,5/16,3/8)	(6)	★★	3	B-57283

**Socket adapter E-form**



Shank Type	Bit type	Length mm	Range	Sales Pkg Qty	Part No.
E-form (MZ)	1/4 inch Drive	50	★★	1	D-74740
	3/8 inch Drive	50	★★	1	B-54667
	3/8 inch Drive	152	★★	1	B-57738
	1/2 inch Drive	50	★★	1	B-54673
	1/2 inch Drive	152	★★	1	B-57744
E-form (NZ)	3/8 inch Drive	50	★★	1	B-54689
	1/2 inch Drive	50	★★	1	B-54695

**Socket bit E-form Semi long type**



Shank Type	Socket Size mm	Length mm	Range	Sales Pkg Qty	Part No.
E-form (NZ)	8	90	★★★	1	A-58914
	10	90	★★★	1	A-58920
	12	90	★★★	1	A-58936
	13	90	★★★	1	A-58942
	14	90	★★★	1	A-58958
	17	90	★★★	1	A-58964
	19	90	★★★	1	A-58970
	21	90	★★★	1	A-58986
	24	90	★★★	1	A-58992

**Socket bit E-form Long type**



Shank Type	Socket Size mm	Length mm	Range	Sales Pkg Qty	Part No.
E-form (MZ)	10	75	★★★	1	B-52526
	10	150	★★★	1	B-52532
	10	300	★★★	1	B-52548
	10	500	★★★	1	B-52554
	10	700	★★★	1	B-52560
	13	75	★★★	1	B-52576
	13	150	★★★	1	B-52582
	13	300	★★★	1	B-52598
	13	500	★★★	1	B-52607
	13	700	★★★	1	B-52613
	17	75	★★★	1	B-52629
	17	150	★★★	1	B-52635
	17	300	★★★	1	B-52641
	17	500	★★★	1	B-52657
	17	700	★★★	1	B-52663

**Thumb screw socket bit E-form**



Shank Type	Socket Size mm	Length mm	Range	Sales Pkg Qty	Part No.
E-form (NZ)	13	100	★★★★★	1	A-66139

**Threaded rod socket bit E-form**



Shank Type	Socket Size mm	Length mm	Range	Sales Pkg Qty	Part No.
E-form (MZ)	M6	66	★★★★★	1	B-42961
	M8	66	★★★★★	1	B-42977
	M10	66	★★★★★	1	B-42983
	M6, M8, M10	66	★★★★★	3	B-42999

**Bit catcher**



Note	Range	Sales Pkg Qty	Part No.
E-form (MZ)	★★★	1	B-54411
E-form (NZ)	★★★	1	B-63105

## Drill & drive bit



Shank Type	Bit type	Length mm	Note	Range	Sales Pkg Qty	Part No.
1/4 Inch Hex	PH 2	55	Drill is for #6 screw	★★	1	D-73209
	PH 2	55	Drill is for #8 screw	★★	1	D-73215
	PH 2	55	Drill is for #10 screw	★★	1	D-73221

## Drill & drive bit spare part



Shank Type	Note	Range	Sales Pkg Qty	Part No.
1/4 Inch Hex	Drill is for #6 screw	★★	1	D-73237
1/4 Inch Hex	Drill is for #8 screw	★★	1	D-73243
1/4 Inch Hex	Drill is for #10 screw	★★	1	D-73259

## Screw bit C-form with bit holder Assortment



Shank Type	Range	Sales Pkg Qty	Part No.
C-form & E-form (MZ)	★★	7	D-73265
	★★	7	D-73271
	★★	11	D-31756
	★★	11	D-64995
	★★	11	D-65006
	★★	26	B-48773
	★★	26	B-48789
	★★	26	B-49890
	★★	26	B-49909
	★★	28x6sets	B-28911-6
	★★	11x12sets	D-30651-12
	★★	12x12sets	D-31083-12
	★★	28x12sets	B-40347-12
	★★	31x12sets	D-30667-12
	★★	31x12sets	D-34936-12
	★★	37x10sets	B-28606-10
	C-form & E-form (NZ)	★★	11
★★		18x6sets	B-45412-6
★★		12x12sets	B-45381-12
★★	31x12sets	B-45406-12	

## Screw bit C & E-form Assortment



Shank Type	Range	Sales Pkg Qty	Part No.
C-form & E-form	★★	43	B-55697
	★★	29	D-73477
C-form & E-form (MZ)	★★	30	B-68339
	★★	32	D-65084
	★★	32	D-65224
	★★	47	D-73461
	★★	18x6sets	B-28896-6
	★★	18x12sets	B-43000-12
	★★	32	D-67642
C-form & E-form (NZ)	★★	18x6sets	B-45397-6

## Screw bit C & E-form Assortment in clear case series



Shank Type	Range	Sales Pkg Qty	Part No.
C-form & E-form (MZ)	★★	24	E-12619
	★★	28	E-07048
	★★	28	E-12625
	★★	32	E-07076
	★★	28x10sets	E-07048-10
	★★	32x10sets	E-07076-10
C-form & E-form (NZ)	★★	28	E-07107
	★★	32	E-07135
	★★	28x10sets	E-07107-10
★★	32x10sets	E-07135-10	

## Screw bit C-form with bit holder Assortment in battery type case



Shank Type	Range	Sales Pkg Qty	Part No.
C-form & E-form (MZ)	★★	31	B-68317
	★★	31x12sets	E-00022
C-form & E-form (NZ)	★★	31	B-69901

**Impact socket**



Shank Type	Socket Size mm	Length mm	Range	Sales Pkg Qty	Part No.	
3/8 Inch Drive	6	28	★★★	1	B-39883	
	7	28	★★★	1	B-39899	
	8	28	★★★	1	B-39908	
	9	28	★★★	1	B-39914	
	10	28	★★★	1	B-39920	
	11	28	★★★	1	B-39936	
	12	28	★★★	1	B-39942	
	13	28	★★★	1	B-39958	
	14	28	★★★	1	B-39964	
	15	28	★★★	1	B-39970	
	16	28	★★★	1	B-39986	
	17	30	★★★	1	B-39992	
	18	30	★★★	1	B-40004	
	19	30	★★★	1	B-40010	
	20	30	★★★	1	B-40026	
	21	30	★★★	1	B-40032	
	22	30	★★★	1	B-40048	
	1/2 Inch Drive	8	38	★★★	1	B-40054
		9	38	★★★	1	B-40060
		10	38	★★★	1	B-40076
		11	38	★★★	1	B-40082
		12	38	★★★	1	B-40098
13		38	★★★	1	B-40107	
14		38	★★★	1	B-40113	
15		38	★★★	1	B-40129	
16		38	★★★	1	B-40135	
17		38	★★★	1	B-40141	
18		38	★★★	1	B-40157	
19		38	★★★	1	B-40163	
20		38	★★★	1	B-40179	
21		38	★★★	1	B-40185	
22	38	★★★	1	B-40191		
23	38	★★★	1	B-40200		
24	38	★★★	1	B-40216		
27	42	★★★	1	B-40222		
30	44	★★★	1	B-40238		
32	44	★★★	1	B-40244		

**Impact socket Assortment**

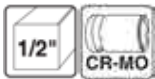

Shank Type	Socket Size mm	Length mm	Range	Sales Pkg Qty	Part No.
1/2 Inch Drive	8 to 21	38	★★★	8	E-02989
	8 to 21	38	★★★	9	B-66232
	8 to 24	38	★★★	9	D-41517
	8 to 24	38	★★★	9	D-42575
	10 to 27	38	★★★	9	B-69749

**Impact socket with socket adapter Assortment**



Shank Type	Bit type	Socket Size mm	Length mm	Range	Sales Pkg Qty	Part No.
E-form (MZ)	1/4 Inch Drive	6 to 13	23	★★★	8	E-12289
	3/8 Inch Drive	8 to 18	28	★★★	9	B-54651
	1/2 Inch Drive	13 to 24	38	★★★	7	B-69733
	1/2 Inch Drive	8 to 18	38	★★★	9	B-54645
E-form (NZ)	3/8 Inch Drive	8 to 10	28	★★★	9	B-55778
	1/2 Inch Drive	8 to 18	38	★★★	9	B-55762

**Impact deep socket**



Shank Type	Socket Size mm	Length mm	Range	Sales Pkg Qty	Part No.	
3/8 Inch Drive	7	63	★★★	1	B-55398	
	8	63	★★★	1	B-55407	
	9	63	★★★	1	B-55413	
	10	63	★★★	1	B-55429	
	11	63	★★★	1	B-55435	
	12	63	★★★	1	B-55441	
	13	63	★★★	1	B-55457	
	14	63	★★★	1	B-55463	
	15	63	★★★	1	B-55479	
	16	63	★★★	1	B-55485	
	17	63	★★★	1	B-55491	
	18	63	★★★	1	B-55500	
	19	63	★★★	1	B-55516	
	20	63	★★★	1	B-55522	
	21	63	★★★	1	B-55538	
	22	63	★★★	1	B-55544	
	1/2 Inch Drive	8	81.5	★★★	1	B-52146
		10	81.5	★★★	1	B-52152
		11	81.5	★★★	1	B-52168
		12	81.5	★★★	1	B-52174
		13	81.5	★★★	1	B-52180
		14	81.5	★★★	1	B-52196
16		81.5	★★★	1	B-52205	
17		81.5	★★★	1	B-52211	
18		81.5	★★★	1	B-52227	
19		81.5	★★★	1	B-52233	
21		81.5	★★★	1	B-52249	
22		81.5	★★★	1	B-52255	
24		81.5	★★★	1	B-52261	
27		81.5	★★★	1	B-52277	
30	81.5	★★★	1	B-52283		
32	81.5	★★★	1	B-52299		

## Impact deep socket Assortment



Shank Type	Socket Size mm	Length mm	Range	Sales Pkg Qty	Part No.
3/8 Inch Drive	8 to 22	63	★★★	14	B-55550
1/2 Inch Drive	10 to 32	81.5	★★★	14	B-52308

## Impact deep socket for wheel nut Assortment



Shank Type	Socket Size mm	Length mm	Range	Sales Pkg Qty	Part No.
1/2 Inch Drive	17, 19, 21	86	★★★	3	E-12354

## Impact socket extension bar



Shank Type	Bit type	Length mm	Range	Sales Pkg Qty	Part No.
1/2 Inch Drive	1/2 inch Drive	75	★★★	1	B-55728
		150	★★★	1	B-55712
		250	★★★	1	B-55706

## Impact socket spare part



Shank Type	Socket Size mm	Note	Range	Sales Pkg Qty	Part No.
1/2 Inch Drive	8 to 16	O ring set	★★★	3	B-54542
	17		★★★	3	B-54558
	18 to 19		★★★	3	B-54564
	20 to 32		★★★	3	B-54570
	8 to 16	Pin set	★★★	3	B-54586
	17		★★★	3	B-54592
	18 to 19		★★★	3	B-54601
	20 to 32		★★★	3	B-54617

## Bit adapter



Shank Type	Bit type	Length mm	Range	Sales Pkg Qty	Part No.
1/2 Inch Drive	E-form (MZ)	51	★★★	1	B-68448
	E-form (NZ)	57	★★★	1	B-68476
3/8 Inch Drive	E-form (MZ)	51	★★★	1	B-68454
	E-form (NZ)	57	★★★	1	B-68482

## Screw bit & socket Assortment in clear case series

*Clear case*



Shank Type	Range	Sales Pkg Qty	Part No.
C-form & E-form (MZ)	★★	30	E-12631
	★★	30	E-07060
	★★	30x10sets	E-07060-10
C-form & E-form (NZ)	★★	30	E-07129
	★★	30x10sets	E-07129-10

## Screw bit & socket with ratchet handle Assortment



Shank Type	Range	Sales Pkg Qty	Part No.
C-form & E-form	★★★	21	B-54081





# ACCESSORIES

## ▣ Drill and Screw Bit Sets

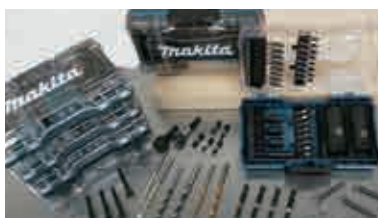

## Accessory set Lineup

Series	Pcs.	Contents							Part No.	
		Drill bit			Hole saw	Screw bit	Nut setter	Hand tool	Screw bit shank type	
		Metal	Wood	Masonry					MZ	NZ
<b>MAKPAC ★★★★★</b>  <p>MAKPAC accessory set comes with Makpac type 1. It consists of drill bit, screw bit and hand tools.</p>	56	✓	✓			✓	✓		B-53768	
	62	✓	✓	✓		✓	✓		B-53908	
	65	✓	✓	✓		✓	✓	✓	B-69478 *Screw bit shank type is C-form	
	66	✓	✓			✓	✓		B-43044	B-43066
	69	✓	✓	✓		✓	✓		B-49638	
	87					✓		✓	E-11542	
	96	✓	✓	✓		✓	✓	✓	B-49725	
	116	✓	✓	✓		✓	✓	✓	B-49884	
	120					✓		✓	E-08713	
<b>MACCESS ★★★★★</b>  <p>MACCESS series contains high quality items of screw bits, drill bits, hand tools, and so on. We are sure that the professional users will be satisfied with these bit sets of MACCESS.</p>	34	✓	✓	✓		✓	✓		D-36980	
	71	✓	✓	✓		✓	✓	✓	D-33691	
	104	✓	✓	✓		✓	✓	✓	D-31778	
	200	✓	✓	✓	✓	✓	✓	✓	D-37194	
<b>Circle ★★★</b>  <p>Circle series comes with bit and hand tool set. These series are more reasonable than MACCESS series.</p>	50	✓	✓	✓		✓		✓	D-42014-6	D-53687
	65					✓		✓	D-42020-6	
	71	✓	✓	✓		✓		✓	D-47145-6	D-53001
	100	✓	✓	✓	✓	✓		✓	D-42036-5	
	103	✓	✓	✓	✓	✓		✓	D-42042-5	D-53017
<b>Square ★★★</b>  <p>Square series does not contain neither high quality expensive items nor hand tools, to keep it less expensive.</p>	17	✓		✓		✓			D-40200	D-53693
	30	✓	✓	✓		✓			D-47204-10	D-53702
	34	✓	✓	✓		✓	✓		B-68498	
	42	✓				✓	✓		D-58877	
	77	✓	✓	✓		✓	✓		D-47226-5	
	100	✓	✓	✓		✓	✓		D-47248-5	
	201	✓	✓	✓	✓	✓	✓		D-47260-2	

Series	Pcs.	Contents							Part No.	
		Drill bit			Hole saw	Screw bit	Nut setter	Hand tool	Screw bit shank type	
		Metal	Wood	Masonry					MZ	NZ
<b>Accessory set ★★★</b>  Accessory set series is the set item with the reasonable price. This is the item eliminating the window on the plastic case of Square series.	60	✓	✓	✓		✓	✓		E-11829	
	75	✓	✓	✓		✓	✓		B-49373	
	100	✓	✓	✓	✓	✓	✓		B-54520	
	102	✓	✓	✓		✓	✓		B-68432	
		✓	✓	✓	✓	✓	✓	✓	E-10730	
	212	✓	✓	✓	✓	✓	✓	✓	E-06270	
	256	✓	✓	✓	✓	✓	✓	✓	E-11689	
<b>Hand tool ★★★</b>  The hand tool series is the set that mainly includes hand tools. Because hand tools are heavy, 8 corners of the case are covered by plastic having impact resistance composites.	76					✓		✓	E-10899	
	87					✓		✓	E-08458	
	120					✓		✓	E-06616	
	221					✓		✓	E-10883	
<b>Tablet case ★★★</b>  This is a slim case set and easy to carry and it is stylish design. You can put in and take out the bits smoothly and it will increase your work effort.	33	✓	✓	✓		✓	✓		B-49389	
<b>Clear case ★★★</b>  Clear cover makes it visible inside. Comparing to current items, clear case was designed to be able to be stacked stably.	8		✓						E-08698 E-08698-10	E-08707 E-08707-10
	18			✓		✓	✓		E-07026 E-07026-10	E-07082 E-07082-10
	27	✓	✓	✓		✓			E-07032 E-07032-10	E-07098 E-07098-10
	28					✓	✓		E-07048 E-07048-10	E-07107 E-07107-10
	29	✓	✓	✓		✓			E-07054 E-07054-10	E-07113 E-07113-10
	30					✓	✓		E-07060 E-07060-10	E-07129 E-07129-10
	32					✓			E-07076 E-07076-10	E-07135 E-07135-10
<b>Clear case ★★★</b> 	47					✓	✓	✓	B-36170-10	
	48	✓				✓	✓		B-36192-10	
<b>Compact case ★★★</b> 	38	✓				✓	✓		B-54106	
	71	✓	✓			✓			B-50295	

# ACCESSORIES

## ▣ Cutting



Dia / Bore



Rake



Tip embedded



Clean cut



Long life



No. Teeth



Ring



Silent



Extra clean cut



PCD tip



Kerf



Rip cut



M-Force



Coated



Sharp



Thickness



Cross cut











Fast cut

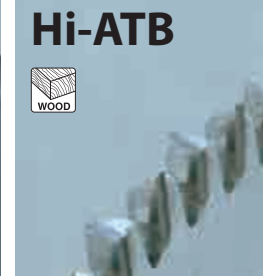

Heavy duty

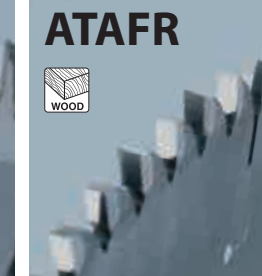
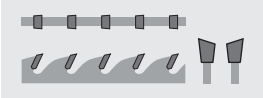
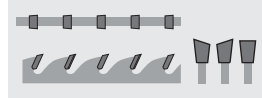
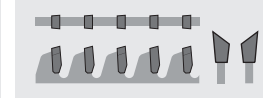
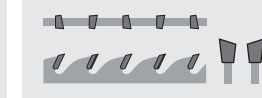
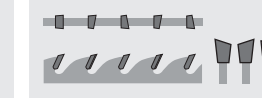

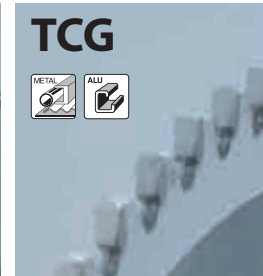

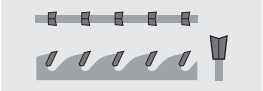
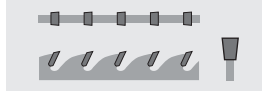
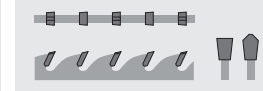
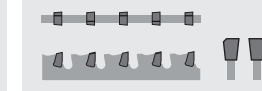
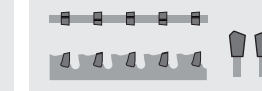
# T.C.T Saw Blade

## Tooth shape

 <p><b>ATB</b></p> <p>WOOD METAL</p>	 <p><b>ATBR</b></p> <p>WOOD</p>	 <p><b>Hi-ATB</b></p> <p>WOOD</p>	 <p><b>ATAF</b></p> <p>WOOD</p>	 <p><b>ATAFR</b></p> <p>WOOD</p>
<p>Alternate top bevel For wood and aluminum.</p>	<p>Added flat teeth to ATB for easy straight cutting</p>	<p>Alternate top bevel (ATB) with a larger top bevel angle</p>	<p>Alternate top alternate face Enables to cut wood fiber sharply.</p>	<p>Added flat teeth to ATAF for easy straight cutting. <b>MATAFR:</b> Modified ATAFR for less cutting resistance.</p>
				
 <p><b>M-FORCE</b></p> <p>WOOD</p>	 <p><b>FTG</b></p> <p>WOOD METAL</p>	 <p><b>TCG</b></p> <p>METAL ALU</p>	 <p><b>MTCG</b></p> <p>METAL</p>	 <p><b>SMTCG</b></p> <p>METAL ALU</p>
<p>Tooth front and top shapes symmetric V groove having features of ATB and FTG.</p>	<p>Flat teeth, allows easy straight cutting and tips are rarely chipped. For cutting wood along the grain and cutting thin metal.</p>	<p>Trapezoidal and flat teeth are arranged alternatively and they divide debris by three. Allows easy straight cutting and tips are rarely chipped.</p>	<p>Flat teeth with alternating bevel Less cutting resistance than flat teeth. Tips are rarely chipped</p>	<p>Contrast to MTCG, asymmet- ric two bevels on a tooth top producing sharp edges Allows easy bite to materials.</p>
				

Cutting

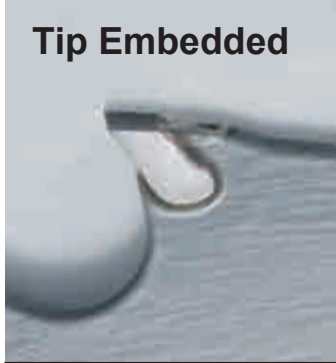
## Technical term

 <p><b>Laser Slit</b></p>	 <p><b>Coated</b></p>	 <p><b>Tip Embedded</b></p>	 <p><b>P.C.D Tip</b></p>
<p>Vibration dampening system Resinbond filled laser cut body slots for smoother and quieter cuts.</p>	<p>PTFE (polytetrafluoroethylene) coating plate to reduce pitch build-up and to lower resistance.</p>	<p>Inserted tooth design will greatly increases the body-to-tip braze area for greater support and tip strength.</p>	<p>PCD (Poly-Crystalline Diamond) tips has extreme hardness and wear resistance. PCD tipped saw blade is the best choice for long lasting performance when cutting fiber cement board.</p>



Feature

**Sharp top angle**

Enable you to make a fine cut surface with only little effort.

**Curved body**

Allows the excellent chip chute performance.

**Slimmed bottom**

Realizes long life battery by saving cutting resistance.

**More cuts per charge**

**Fast cutting**

**Longer life**

The amount of cutting per 1 charge

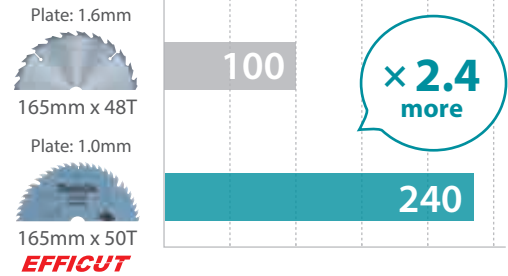

The test results depend to a great extent on the hardness of wood materials, etc.



This movie was filmed in Japan. Models and specs may vary by country.

★★★★★

**for Wood**  
**Ideal for Cordless Circular Saw**



Outer dia (mm)	Range	Material	No. of teeth	Kerf (mm)	Plate (mm)	Rake	Tooth shape	Bore (mm)	Ring (mm)	Note	Per pkg	Part No.
125	★★★★★	Wood	45	1.4	1.0	23	ATAFR	20	-	-	1	B-69462
165	★★★★★	Wood	25	1.4	1.0	23	ATAFR	20	-	-	1	B-63018
		Wood/MDF	56	1.45	1.0	23	ATAFR	20	-	-	1	B-57364
185	★★★★★	Wood	24	1.45	1.0	23	ATAFR	20	-	-	1	B-62022
		Wood	45	1.45	1.0	23	ATAFR	20	-	-	1	B-68616
190	★★★★★	Wood	24	1.45	1.0	23	ATAFR	20	-	-	1	B-64200
		Wood	45	1.45	1.0	23	ATAFR	20	-	-	1	B-68644
235	★★★★★	Wood	24	2.2	1.5	20	ATBR	25	-	-	1	E-01959
260	★★★★★	Wood	24	2.15	1.5	23	ATAFR	25	-	-	1	E-07733
270	★★★★★	Wood	24	2.15	1.5	20	ATAFR	25.4	-	-	1	E-12974

**Ideal for Cordless Plunge Saw**



Outer dia (mm)	Range	Material	No. of teeth	Kerf (mm)	Plate (mm)	Rake	Tooth shape	Bore (mm)	Ring (mm)	Note	Per pkg	Part No.
165	★★★★★	Wood/MDF	56	1.45	1.0	23	ATAFR	20	-	for Plunge Cut Circular Saw	1	B-57364

**Ideal for Cordless Metal Cutter**



Outer dia (mm)	Range	Material	No. of teeth	Kerf (mm)	Plate (mm)	Rake	Tooth shape	Bore (mm)	Ring (mm)	Note	Per pkg	Part No.
150	★★★★★	Wood	25	1.4	1.0	23	ATAFR	20	-	for Metal Cutter	1	E-06937

**Ideal for Cordless Slide Compound Saw**



Outer dia (mm)	Range	Material	No. of teeth	Kerf (mm)	Plate (mm)	Rake	Tooth shape	Bore (mm)	Ring (mm)	Note	Per pkg	Part No.
165	★★★★★	Wood	60	1.85	1.4	10	ATBR	20	-	-	1	B-69892
190	★★★★★	Wood	25	1.85	1.35	10	ATBR	20	-	-	1	E-11265
		Wood	45	1.85	1.35	10	ATBR	20	-	-	1	E-11271
		Wood	60	1.85	1.35	10	ATBR	20	-	-	1	E-11287
216	★★★★★	Wood	45	2	1.5	10	ATBR	25.4	-	-	1	E-07010
		Wood	60	2	1.5	10	ATBR	25.4	-	-	1	E-08969
260	★★★★★	Wood	45	2.15	1.7	10	ATBR	25.4	-	-	1	B-64668
		Wood	60	2.15	1.7	10	ATBR	25.4	-	-	1	B-67430
		Wood	80	2.15	1.7	10	ATBR	25.4	-	-	1	B-67446
305	★★★★★	Wood	60	2.15	1.7	10	ATBR	25.4	-	-	1	B-67452
		Wood	80	2.15	1.7	10	ATBR	25.4	-	-	1	B-67468
		Wood	100	2.15	1.7	10	ATBR	25.4	-	-	1	B-67474

Cutting



**Feature**

**Curved body**

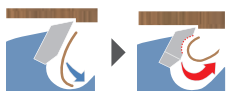

Allows the excellent chip chute performance.

**Slimmed bottom**

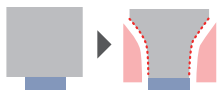

Realizes long life battery by saving cutting resistance.

**The amount of cutting per 1 charge**

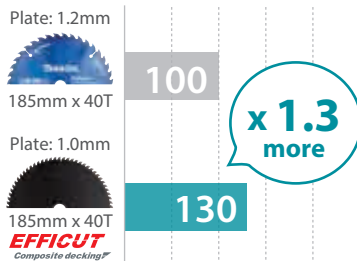

Model: DHS780 (BL1860B)  
Material : Composite decking  
(WxH =137mm x 23mm)

**Following the tooth design of Efficut for wood with**

- Tip hardness was improved
- Having obtuse tip angle then realized longer life and more cuts per charge.

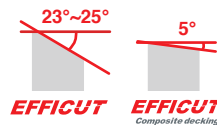

**Life**

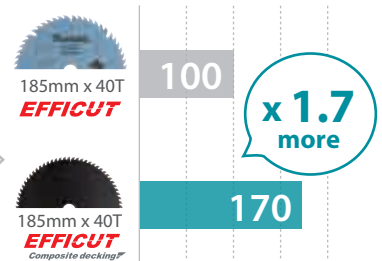

Model: DRS780 (BL1860)  
Material : Composite decking  
(WxH =139mm x 22mm)

★★★★★

**for Composite deck  
Ideal for Cordless Circular Saw**



Outer dia (mm)	Range	Material	No. of teeth	Kerf (mm)	Plate (mm)	Rake	Tooth shape	Bore (mm)	Ring (mm)	Note	Per pkg	Part No.
185	★★★★★	Composite deck	40	1.5	1.0	15	ATAFR	20	-	-	1	E-11972

Ideal for Cordless Slide Compound Saw



Outer dia (mm)	Range	Material	No. of teeth	Kerf (mm)	Plate (mm)	Rake	Tooth shape	Bore (mm)	Ring (mm)	Note	Per pkg	Part No.
260	★★★★★	Composite deck	75	2.15	1.7	8	ATAFR	30	-	-	1	E-11988



Feature

Cutting

**Strong and least chipping**

Special blade tip design greatly improves efficiency and durability.

**Release swarf smoothly**

**Superior in straight cutting**

The load on blade tips can be distributed efficiently to suppress wobbling of saw blade, providing steady straight cutting and increased durability against tip breakage.

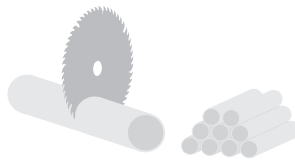

More cuts per charge



Fast cutting



Longer life

The amount of cutting per 1 charge

Plate: 1.2mm



150mm x 32T

Plate: 0.95mm



150mm x 33T  
**EFFICUT Metal**



Model: DCS553 (BL1860B)  
Material: Carbon steel pipe (Dia: 31mm / Thickness: 3mm)



This movie was filmed in Japan.  
Models and specs may vary by country.

★★★★★

for Metal  
Ideal for Cordless Metal Cutter



Outer dia (mm)	Range	Material	No. of teeth	Kerf (mm)	Plate (mm)	Rake	Tooth shape	Bore (mm)	Ring (mm)	Note	Per pkg	Part No.
136	★★★★★	Metal	30	1.1	1.0	0	SMTCG	20	-	-	1	B-69428
		Metal & SUS	45	1.1	1.0	0	SMTCG	20	-	-	1	B-69434
150	★★★★★	Metal	33	1.1	1.0	0	SMTCG	20	-	-	1	B-69440
		Metal & SUS	48	1.1	1.0	0	SMTCG	20	-	-	1	B-69456
185	★★★★★	Metal	45	1.4	1.2	0	SMTCG	20	-	-	1	E-12918
		Metal & SUS	60	1.4	1.2	0	SMTCG	20	-	-	1	E-12924

Ideal for Cordless Metal Cutting Saw



Outer dia (mm)	Range	Material	No. of teeth	Kerf (mm)	Plate (mm)	Rake	Tooth shape	Bore (mm)	Ring (mm)	Note	Per pkg	Part No.
305	★★★★★	Metal	63	2.0	1.75	-2	SMTCG	25.4	-	-	1	E-12083

**Ideal for Cordless Steel Rod Cutter (DSC251)**

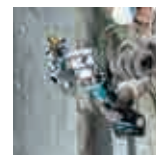

Outer dia (mm)	Range	Material	No. of teeth	Kerf (mm)	Plate (mm)	Rake	Tooth shape	Bore (mm)	Ring (mm)	Note	Per pkg	Part No.
110	★★★★★	Metal	24	1.5	1.10	0	SMTCG	34	-	-	1	E-11097



**Feature**

**Strong and least chipping**  
Special blade tip design greatly improves efficiency and durability.

**Superior in straight cutting**  
The load on blade tips can be distributed efficiently to suppress wobbling of saw blade, providing steady straight cutting and increased durability against tip breakage.

**Reduce cutting resistance**  
Realizes high durability and reduce cut resistance.

**Allows the excellent chip ejection.**  
Realizes long life battery by saving cutting resistance.

**More cuts per charge**

**Fast cutting**

**Longer life**

**Clean cutting**

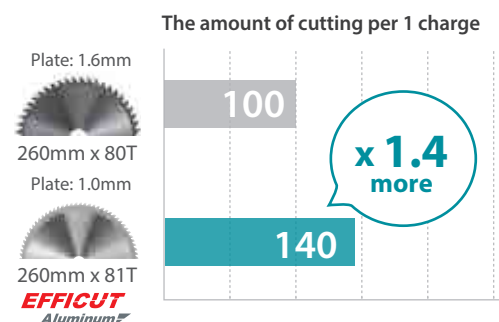

Model: DLS110(BL1860B x2)  
Material : Aluminum frame (WxH=45x45mm, t=2mm)



This movie was filmed in Japan. Models and specs may vary by country.

**★★★★★  
for Aluminum  
Ideal for Cordless Slide Compound Saw**



Outer dia (mm)	Range	Material	No. of teeth	Kerf (mm)	Plate (mm)	Rake	Tooth shape	Bore (mm)	Ring (mm)	Note	Per pkg	Part No.
260	★★★★★	Aluminum	81	1.85	1.5	-3	SMTCG	25.4	-	-	1	E-06345
305	★★★★★	Aluminum	81	2.0	1.65	-3	SMTCG	25.4	-	-	1	E-12918
		Aluminum	96	2.0	1.65	-3	SMTCG	25.4	-	-	1	E-12924

## for Wood



(Circular Saw) &amp; (Plunge Cut Circular Saw)

Outer dia (mm)	Range	Material	No. of teeth	Kerf (mm)	Plate (mm)	Rake	Tooth shape	Bore (mm)	Ring (mm)	Note	Per pkg	Part No.	
85	★★★	Wood	20	1.00	0.70	10	ATB	15	-	for Coradless Saw	1	B-14607	
110	★★★	Wood	12	1.85	1.25	20	ATB	20	-	-	1	A-81723	
		Wood	24	1.60	1.00	10	ATAF	20	-	Fast cut	1	B-16944	
		Wood	24	1.80	1.20	10	ATAF	20	-	-	1	A-88864	
		Wood	30	1.60	1.00	10	ATAF	20	-	-	1	B-16950	
		Wood	30	1.80	1.20	10	ATB	20	-	-	1	A-81365	
	★★	Wood	12	1.70	1.10	15	ATB	20	-	-	1	D-15562	
		Wood	24	1.70	1.10	10	ATB	20	-	-	1	D-15578	
		Wood	30	1.60	1.00	10	SMTCG	20	-	-	1	B-39475	
136	★★★	Wood	16	1.50	1.00	20	ATAF	20	-	for Coradless Saw	1	B-09949	
		Wood	16	1.50	1.00	20	ATAF	20	-	-	1	B-53659	
		Wood	36	1.50	1.00	18	ATAF	20	-	-	1	B-46800	
160	★★★	Wood	24	1.80	1.20	25	ATAF	20	-	Fast cut	1	B-16966	
		Wood	24	2.20	1.40	25	ATAF	20	-	-	1	A-81371	
		Wood	30	1.80	1.20	20	ATB	20	-	-	1	B-16972	
		Wood	30	2.20	1.40	20	ATAF	20	-	-	1	A-81876	
		Wood	32	2.20	1.40	20	ATAF	20	-	-	1	A-81387	
		Wood	36	1.80	1.20	20	ATAF	20	-	Fast cut	1	B-16988	
		Wood	36	2.20	1.40	20	ATAF	20	-	-	1	A-81882	
		Wood	40	1.60	1.00	18	ATB	20	-	-	1	A-80612	
		Wood	40	1.80	1.20	20	ATAF	20	-	Fast cut	1	B-16994	
		Wood	40	2.20	1.40	20	ATAF	20	-	-	1	A-81898	
		Wood	48	1.80	1.20	20	ATAF	20	-	Fast cut	1	B-17005	
		Wood	48	2.20	1.40	20	ATAF	20	-	-	1	A-81907	
		Wood	60	1.80	1.20	15	ATAF	20	-	Fast cut	1	B-17011	
	Wood	60	2.00	1.40	15	ATAF	20	-	-	1	A-82688		
	Wood	60	2.20	1.40	15	ATB	20	-	-	1	A-81393		
	★★	Wood	16	2.00	1.30	20	ATB	20	16	-	-	1	D-16433
		Wood	24	2.00	1.30	20	ATB	20	16	-	-	1	D-34257
		Wood	40	2.00	1.30	18	ATB	20	16	-	-	1	D-34263
	165	★★★★★	Wood	25	1.40	1.00	23	ATAFR	20	-	EFFICUT	1	B-63018
			Wood	10	2.00	1.40	20	FTG	20	-	-	1	B-02917
Wood			16	2.00	1.20	15	M-FORCE	20	-	-	1	A-89698	
Wood			24	1.50	1.00	20	ATAF	20	-	for Coradless Saw	1	A-85101	
Wood			28	2.00	1.40	23	ATB	20	-	Fast cut for Plunge Cut Circular Saw	1	B-56649	
Wood			28	2.20	1.60	15	ATB	20	-	for Plunge Cut Circular Saw	1	B-07434	
Wood			40	1.60	1.00	18	ATAF	20	-	Economy	1	B-17027	
Wood			40	1.60	1.00	18	ATAF	20	-	-	1	A-82454	
Wood			40	1.60	1.00	18	ATAF	20	-	for Coradless Saw	1	A-85226	
Wood			44	1.45	1.00	23	ATAFR	20	-	-	1	B-53285	
Wood			48	1.85	1.25	8	ATB	20	-	Fast cut for Plunge Cut Circular Saw	1	B-56166	
Wood			48	2.20	1.60	8	ATB	20	-	for Plunge Cut Circular Saw	1	B-07353	
Wood			52	1.60	1.00	20	ATAF	20	-	for Coradless Saw	1	A-85189	
Wood			60	1.60	1.00	18	ATAF	20	-	-	1	A-82460	
Wood			64	1.90	1.40	10	ATAF	20	-	-	1	B-56487	
Wood/NAIL			16	2.00	1.25	23	ATB	20	-	-	1	A-86022	
Wood/NAIL			24	2.00	1.25	23	ATB	20	-	-	1	A-86038	
Wood/NAIL			40	2.00	1.25	18	ATB	20	-	-	1	A-86044	
★★		Wood	10	2.00	1.30	20	ATB	20	-	-	1	D-03327	
		Wood	16	1.50	1.00	20	ATB	20	-	Fast cut	1	D-51079	
		Wood	16	2.00	1.30	20	ATB	20	-	-	1	D-09628	
		Wood	24	2.00	1.30	20	ATB	20	-	-	1	D-03333	
		Wood	40	2.00	1.30	18	ATB	20	-	-	1	D-03349	
		Wood	16/24/40	2.00	1.30	20/20/18	ATB	20	-	-	3	D-44753	

Outer dia (mm)	Range	Material	No. of teeth	Kerf (mm)	Plate (mm)	Rake	Tooth shape	Bore (mm)	Ring (mm)	Note	Per pkg	Part No.
165	★	Wood	16	2.00	1.20	12	ATB	20	-	-	1	D-50485
		Wood	24	2.00	1.20	12	ATB	20	-	-	1	D-50491
		Wood	40	2.00	1.20	12	ATB	20	-	-	1	D-50500
										10	D-50500-10	
180	★★★★	Wood	24	1.80	1.20	25	ATAF	20	-	Economy	1	B-17033
		Wood	24	2.20	1.40	25	ATAF	20	-	-	1	A-81402
		Wood	30	1.80	1.20	20	ATB	20	-	Economy	1	B-17049
		Wood	30	2.20	1.40	20	ATAF	20	-	-	1	A-81913
		Wood	36	1.80	1.20	20	ATAF	20	-	Economy	1	B-17055
		Wood	36	2.20	1.40	20	ATAF	20	-	-	1	A-81929
		Wood	40	1.80	1.20	20	ATAF	20	-	Economy	1	B-17061
		Wood	40	2.20	1.40	20	ATAF	20	-	-	1	A-81418
		Wood	48	1.80	1.20	20	ATAF	20	-	Economy	1	B-17077
		Wood	48	2.20	1.40	20	ATAF	20	-	-	1	A-81935
		Wood	60	2.00	1.40	15	ATAF	20	-	Fast cut	1	A-82694
										1	A-81424	
185	★★★★★	Wood	24	1.45	1.00	23	ATAFR	20	-	EFFICUT	1	B-62022
		Wood	45	1.45	1.00	23	ATAFR	20	-	EFFICUT	1	B-68616
	★★★★	Wood	40	1.60	1.00	18	ATAF	20	-	Economy	1	B-17083
		Wood	40	1.60	1.00	18	ATAF	20	-	Fast cut	1	A-82476
		Wood	40	2.00	1.40	18	ATAF	20	-	-	1	A-85999
		Wood	60	1.60	1.00	18	ATAF	20	-	-	1	A-82482
		Wood/NAIL	20	1.85	1.25	25	ATB	20	-	-	1	A-83814
		Wood/NAIL	40	2.00	1.25	25	ATB	30	20	-	1	A-86072
	★★	Wood	16	2.00	1.30	20	ATB	30	20/16	-	1	D-03903
		Wood	20	2.00	1.30	20	ATB	30	20/16	-	1	D-09634
		Wood	24	1.80	1.20	20	ATB	20	-	Fast cut	1	D-19037
		Wood	24	1.80	1.20	20	ATB	20	-	Economy	1	D-51275
		Wood	24	2.00	1.30	20	ATB	20	-	-	1	D-03355
		Wood	40	2.00	1.30	18	ATB	20	-	-	1	D-03361
		Wood	40	2.00	1.30	18	ATB	30	20/16	-	1	D-03919
		Wood	16, 20	2.00	1.30	20	ATB	30	16, 20	-	2	D-20052
		Wood	16/24/40	2.00	1.30	20/20/18	ATB	30	-	-	3	D-44769
		Wood	16/24/40	1.8/1.8/2.0	1.2/1.2/1.3	20/20/18	ATB	20	-	-	3	D-34285
		Wood	24/24	1.8/1.8	1.2/1.2	20	ATB	20	-	-	2	D-34279
		Wood	24/40	1.8/2.0	1.2/1.3	20/18	ATB	20	-	-	2	D-19043
		Wood	24/40	1.8/2.0	1.2/1.3	20/18	ATB	20	-	-	2	D-21412
		Wood	24/40	1.8/2.2	1.2/1.5	20/5	ATB	20	-	-	2	D-21397
		Wood	24/60	1.8/2.4	1.2/1.6	20/12	ATB	20	-	-	2	D-21406
	★	Wood	16	2.20	1.40	18	ATB	25.4	20	-	1	D-50516
		Wood	20	2.20	1.40	15	ATB	25.4	20	-	1	D-59112
		Wood	24	2.20	1.40	15	ATB	25.4	20	-	1	D-50522
		Wood	24	2.20	1.40	15	ATB	25.4	20	-	10	D-50522-10
Wood		40	2.20	1.40	14	ATB	25.4	20	-	1	D-50538	
190	★★★★★	Wood	24	1.45	1.00	23	ATAFR	20	-	EFFICUT	1	B-64200
		Wood	45	1.45	1.00	23	ATAFR	20	-	EFFICUT	1	B-68644
	★★★★	Wood	24	2.00	1.40	20	ATAF	20	-	-	1	A-87507
		Wood	44	1.45	1.00	23	ATAFR	20	-	-	1	B-54514
	★	Wood	40	2.20	1.40	15	ATB	25.4	20	-	1	D-74924
										10	D-74924-10	
										25	D-74924-25	
210	★★	Wood	24	2.00	1.30	20	ATB	25	-	-	1	D-34291
		Wood	24	2.00	1.30	20	ATB	25	-	-	1	D-29066
		Wood	40	2.00	1.30	18	ATB	25	-	-	1	D-34300
	★	Wood	24	2.50	1.60	15	ATB	25	-	-	1	D-72344
		Wood	40	2.50	1.60	15	ATB	25	-	-	1	D-72350
235	★★★★★	Wood	24	2.20	1.50	20	ATBR	25	-	EFFICUT	1	E-01959
		Wood	20	2.30	1.60	25	ATAF	20	-	-	1	A-80678
		Wood	20	2.30	1.60	20	ATB	25	-	-	1	A-89947
		Wood	20	2.30	1.60	15	M-FORCE	20	-	-	1	B-04092
		Wood	24	2.40	1.60	25	ATAF	25.4	25	Economy	1	B-17164
		Wood	24	2.60	1.80	25	ATB	25.4	-	-	1	A-81985
		Wood	30	2.40	1.60	25	ATB	25.4	25	Economy	1	B-17170
										1	A-81991	

Outer dia (mm)	Range	Material	No. of teeth	Kerf (mm)	Plate (mm)	Rake	Tooth shape	Bore (mm)	Ring (mm)	Note	Per pkg	Part No.	
235	★★★	Wood	36	2.40	1.60	25	ATB	25.4	25	Economy	1	B-17186	
		Wood	36	2.60	1.80	25	ATB	25.4	25	-	1	A-82002	
		Wood	40	2.30	1.60	15	M-FORCE	20	-	-	1	B-04101	
		Wood	40	2.40	1.60	25	ATB	25.4	25	Economy	1	B-17192	
		Wood	40	2.60	1.80	25	ATAF	25.4	25	-	1	A-81468	
		Wood	48	2.40	1.60	20	ATB	25.4	25	Economy	1	B-17201	
		Wood	48	2.60	1.80	20	ATAF	25.4	25	-	1	A-82018	
		Wood	60	2.40	1.60	20	ATAF	25.4	25	Economy	1	B-17217	
		Wood	60	2.40	1.60	20	ATAF	25.4	25	-	1	A-82719	
		Wood	60	2.60	1.80	20	ATAF	25.4	25	-	1	A-81474	
		Wood	80	2.40	1.60	15	ATAF	25.4	25	Economy	1	B-17223	
		Wood	80	2.40	1.60	15	ATAF	25.4	-	-	1	B-45602	
	Wood	80	2.60	1.60	15	ATB	25.4	25	-	1	A-81480		
	Wood	100	2.40	1.60	10	ATAF	25.4	-	-	1	B-45618		
	Wood	20	2.40	1.60	20	ATB	30	25.4/25	-	1	D-03925		
	Wood	20	2.40	1.60	20	ATB	25	-	-	1	D-15811		
	Wood	40	2.40	1.60	18	ATB	25.4	25	-	1	D-03377		
	Wood	40	2.40	1.60	18	ATB	25	-	-	1	D-16570		
	Wood	48	2.40	1.60	18	ATB	30	25	-	1	D-03931		
	Wood	60	2.40	1.60	15	ATB	30	25	-	1	D-09640		
	Wood	60	2.40	1.60	15	ATB	25	-	-	1	D-34322		
	Wood	80	2.80	1.80	12	TCG	30	25	-	1	D-17918		
	Wood	20/48	2.40	1.60	18/20	ATB	30	25, 25.4	-	2	D-20068		
	Wood	20/48	2.40	1.60	20/18	ATB	30	25, 25.4	-	2	D-21602		
	Wood	20/48/60	2.40	1.60	20/18/15	ATB	30	-	-	3	D-44775		
	Wood	24/24	2.4/2.4	1.6/1.6	20	ATB	25	-	-	2	D-34316		
	Wood	24/40	2.40	1.60	20/18	ATB	25	-	-	2	D-21319		
	Wood	20	2.50	1.60	14	ATB	25.4	25	-	1	D-50544		
	Wood	40	2.50	1.60	12	ATB	25.4	25	-	1	D-50550		
	Wood	48	2.50	1.60	12	ATB	25.4	25	-	1	D-59128		
	Wood	60	2.50	1.60	12	ATB	25.4	25	-	1	D-50566		
	260	★★★★★	Wood	24	2.15	1.50	23	ATAFR	25	-	EFFICUT	1	E-07733
		★★★	Wood	24	2.30	1.60	20	ATB	25.4	-	-	1	B-10584
270	★★★	Wood	24	2.15	1.50	23	ATAFR	25.4	-	EFFICUT	1	E-12974	
		Wood	18	2.60	1.80	20	ATB	30	-	-	1	B-12859	
		Wood	24	2.60	1.80	23	ATB	30	25	-	1	A-81804	
		Wood	40	2.60	1.80	18	ATB	30	25	-	1	A-81816	
		Wood	60	2.60	1.80	18	ATB	30	25	-	1	A-81826	
335	★★★	Wood	60	3.00	2.20	20	ATB	25	-	-	1	B-12603	
		Wood	20	3.00	2.20	27	ATAF	30	-	-	1	A-80014	
		Wood	24	3.00	2.20	23	ATB	30	-	-	1	A-81832	
		Wood	40	3.00	2.20	23	ATB	30	-	-	1	A-81848	
		Wood	60	3.00	2.20	18	ATB	30	-	-	1	A-81854	
415	★★★	Wood	60	2.60	1.80	20	ATAF	25	-	-	1	792118-8	



(Cordless Metal Cutter)

Outer dia (mm)	Range	Material	No. of teeth	Kerf (mm)	Plate (mm)	Rake	Tooth shape	Bore (mm)	Ring (mm)	Note	Per pkg	Part No.
150	★★★★★	Wood	25	1.40	1.00	23	ATAFR	20	-	EFFICUT	1	E-06937



(Slide Compound Saw / Miter Saw)

Outer dia (mm)	Range	Material	No. of teeth	Kerf (mm)	Plate (mm)	Rake	Tooth shape	Bore (mm)	Ring (mm)	Note	Per pkg	Part No.
165	★★★★★	Wood	60	1.85	1.35	10	ATBR	20	-	EFFICUT	1	B-69892
	★★★	Wood	64	1.90	1.40	10	ATAF	20	-	-	1	B-56487
190	★★★	Wood	24	2.00	1.40	-5	ATB	20	-	-	1	B-03866
		Wood	24	2.20	1.60	5	ATB	20	-	-	1	B-03850

Outer dia (mm)	Range	Material	No. of teeth	Kerf (mm)	Plate (mm)	Rake	Tooth shape	Bore (mm)	Ring (mm)	Note	Per pkg	Part No.	
190	★★★	Wood	24	2.20	1.60	5	ATB	20	-	-	1	B-04298	
		Wood	40	1.90	1.40	10	ATB	20	-	for Cordless Slide Compound Saw	1	A-86147	
		Wood	40	2.00	1.40	10	ATAF	20	-	-	1	A-86751	
		Wood	60	2.00	1.40	-5	ATB	20	-	-	1	B-03981	
		Wood	60	2.00	1.40	5	ATB	20	-	-	1	B-04008	
		Wood	72	2.00	1.40	10	ATAF	20	-	-	1	A-86359	
210	★★★	Wood	18	1.90	1.40	25	ATB	30	25	-	1	A-81767	
216	★★★★★	Wood	45	2.00	1.50	10	ATBR	25.4	-	EFFICUT	1	E-07010	
		Wood	60	2.00	1.50	10	ATBR	25.4	-	EFFICUT	1	E-08969	
		Wood	80	2.00	1.50	10	ATBR	25.4	-	EFFICUT	1	E-08975	
	★★★	Wood	40	2.10	1.60	10	ATB	25.4	25	-	-	1	A-86153
		Wood	48	2.40	1.60	5	ATAF	25.4	-	-	-	1	B-39497
		Wood	80	2.20	1.60	10	ATAF	25.4	-	-	-	1	B-45593
		Wood	100	2.20	1.60	10	ATAF	25.4	-	-	-	1	B-51390
★	Wood	80	2.20	1.40	16	ATAF	25.4	-	-	-	1	D-75057	
255	★★★	Wood	32	2.30	1.80	5	ATAF	25.4	-	-	1	A-83696	
		Wood	40	2.20	1.70	10	ATAF	25.4	-	-	1	B-10322	
		Wood	40	2.30	1.80	5	ATB	25.4	-	-	1	B-03626	
		Wood	50	2.3	1.80	15	ATAF	30	15.88	-	-	1	A-80977
		Wood	60	2.30	1.80	5	ATB	25.4	-	-	-	1	B-03632
		Wood	80	2.30	1.80	5	ATB	25.4	-	-	-	1	B-03648
		Wood	120	2.30	1.80	10	ATAF	25.4	-	-	-	1	B-45646
	★★	Wood	80	2.60	1.80	12	ATB	30	25.4	-	-	1	D-34388
★	Wood	40	2.20	1.80	15	ATB	25.4	-	-	-	1	D-74055	
260	★★★★★	Wood	45	2.15	1.65	10	ATBR	25.4	-	EFFICUT	1	B-64668	
		Wood	60	2.15	1.65	10	ATBR	25.4	-	EFFICUT	1	B-67430	
		Wood	80	2.15	1.65	10	ATBR	25.4	-	EFFICUT	1	B-67446	
	★★★	Wood	60	2.3	1.80	5	ATAF	30	15.88	-	-	1	B-11019
		Wood	64	2.30	1.80	5	ATAF	25	-	-	-	1	792695-0
		Wood	70	2.30	1.80	5	ATAF	30	15.88	-	-	1	B-04597
	★★	Wood	100	2.60	2.00	12	ATB	25.4	15.88	-	-	1	D-34394
	★	Wood	40	2.60	1.80	15	ATB	25.4	-	-	-	1	D-65414
		Wood	60	2.60	1.80	15	ATB	25.4	-	-	-	1	D-65420
Wood		80	2.60	1.80	12	ATB	25.4	-	-	-	1	D-65436	
Wood		100	2.60	1.80	12	ATB	25.4	-	-	-	1	D-65442	
305	★★★★★	Wood	60	2.15	1.65	10	ATBR	25.4	-	EFFICUT	1	B-67452	
		Wood	80	2.15	1.65	10	ATBR	25.4	-	EFFICUT	1	B-67468	
		Wood	100	2.15	1.65	10	ATBR	25.4	-	EFFICUT	1	B-67474	
	★★★	Wood	40	2.30	1.80	5	ATB	25.4	-	-	-	1	B-03660
		Wood	60	2.30	1.80	5	ATAF	25.4	-	-	-	1	B-02808
		Wood	60	2.30	1.80	5	ATB	25.4	-	-	-	1	B-03676
		Wood	60	2.60	2.00	10	ATAF	25.4	-	-	-	1	A-85472
		Wood	70	2.50	1.90	0	ATAF	25.4	-	-	-	1	B-57560
		Wood	80	2.30	1.80	5	ATB	25.4	-	-	-	1	B-03682
		Wood	96	2.30	1.80	5	ATAF	25.4	-	-	-	1	B-02814
		Wood	100	2.30	1.80	5	ATB	25.4	-	-	-	1	B-03698
	★★	Wood	100	3.20	2.40	15	ATB	25.4	-	-	-	1	D-34403
	★	Wood	60	2.80	2.00	15	ATB	25.4	-	-	-	1	D-72366
		Wood	80	2.80	2.00	15	ATB	25.4	-	-	-	1	D-72372
Wood		100	2.80	2.00	15	ATB	25.4	-	-	-	1	D-72388	
355	★★★	Wood	60	2.60	2.00	10	ATB	25.4	-	-	1	A-85488	
		Wood	60	3.00	2.20	20	ATB	25	-	-	1	A-02618	



(Table Saw)

Outer dia (mm)	Range	Material	No. of teeth	Kerf (mm)	Plate (mm)	Rake	Tooth shape	Bore (mm)	Ring (mm)	Note	Per pkg	Part No.	
203	★★★	Wood	24	2.00	1.40	25	ATAF	25.4	25	Economy	1	B-17099	
		Wood	24	2.40	1.60	25	ATB	25.4	-	-	1	A-81941	
		Wood	30	2.00	1.40	25	ATB	25.4	25	Economy	1	B-17108	
		Wood	30	2.40	1.60	25	ATB	25.4	25	-	1	A-81957	
		Wood	36	2.00	1.40	20	ATB	25.4	25	Economy	1	B-17114	
		Wood	36	2.40	1.60	20	ATAF	25.4	-	-	1	A-81963	
		Wood	40	2.00	1.40	20	ATAF	25.4	25	Economy	1	B-17120	
		Wood	40	2.00	1.40	20	ATAF	25.4	25	-	1	A-82498	
		Wood	40	2.40	1.60	20	ATAF	25.4	25	-	1	A-81430	
		Wood	48	2.00	1.40	20	ATAF	25.4	25	Economy	1	B-17136	
		Wood	48	2.40	1.60	20	ATAF	25.4	25	-	1	A-81979	
		Wood	60	2.00	1.40	15	ATAF	25.4	25	Economy	1	B-17142	
		Wood	60	2.00	1.40	15	ATAF	25.4	25	-	1	A-82507	
		Wood	60	2.20	1.60	15	ATAF	25.4	25	-	1	A-82703	
210	★★★	Wood	60	2.40	1.60	15	ATAF	25.4	25	-	1	A-81446	
		Wood	80	2.00	1.40	15	ATAF	25.4	25	Economy	1	B-17158	
210	★★★	Wood	80	2.40	1.60	15	ATB	25.4	25	-	1	A-81452	
		Wood	80	2.00	1.40	8	FTG	25	-	-	1	792438-0	
255	★★★	Wood	24	2.30	1.60	20	ATB	25.4	-	-	1	B-05000	
		Wood	24	2.40	1.80	25	ATAF	25.4	25	-	1	A-82513	
		Wood	24	2.40	1.80	25	ATAF	25.4	-	-	1	A-87890	
		Wood	24	2.80	2.00	25	ATAF	25.4	25	Economy	1	B-17239	
		Wood	24	3.20	2.20	25	ATB	25.4	25	-	1	A-82024	
		Wood	30	2.80	2.00	25	ATB	25.4	25	Economy	1	B-17245	
		Wood	30	3.20	2.20	25	ATB	25.4	25	-	1	A-82030	
		Wood	36	2.80	2.00	25	ATB	25.4	25	Economy	1	B-17251	
		Wood	36	3.20	2.20	25	ATB	25.4	-	-	1	A-82046	
		Wood	40	2.30	1.60	20	ATB	25.4	-	-	1	B-05088	
		Wood	40	2.40	1.80	20	ATAF	25.4	25	-	1	A-82529	
		Wood	40	2.80	2.00	25	ATB	25.4	25	Economy	1	B-17267	
		Wood	40	2.80	2.00	25	ATB	25.4	25	-	1	A-81496	
		Wood	40	3.20	2.20	25	ATB	25.4	25	-	1	A-82725	
		Wood	48	2.80	2.00	20	ATB	25.4	25	Economy	1	B-17273	
		Wood	48	3.20	2.20	20	ATAF	25.4	25	-	1	A-82052	
		Wood	60	2.40	1.80	20	ATAF	25.4	25	Economy	1	B-17289	
		Wood	60	2.80	2.00	20	ATAF	25.4	25	-	1	A-81505	
		Wood	80	2.40	1.80	15	ATAF	25.4	25	Economy	1	B-17295	
		255	★	Wood	80	2.80	2.00	15	ATAF	25.4	25	-	1
	Wood			80	2.80	2.00	15	ATB	25.4	25	-	1	A-81511
305	★★★	Wood	100	2.60	2.00	15	ATAF	25.4	25	-	1	A-82292	
		Wood	120	2.60	2.00	15	ATAF	25.4	25	-	1	A-82301	
		Wood	40	2.60	1.80	15	ATB	25.4	-	-	1	D-74061	
		Wood	30	3.00	2.20	25	ATB	25.4	25	Economy	1	B-17332	
		Wood	30	3.40	2.40	25	ATAF	25.4	25	-	1	A-82068	
		Wood	36	3.00	2.20	25	ATB	25.4	25	Economy	1	B-17348	
		Wood	36	3.40	2.40	25	ATB	25.4	25	-	1	A-82074	
		Wood	40	3.00	2.20	25	ATB	25.4	25	Economy	1	B-17354	
		Wood	40	3.40	2.40	25	ATB	25.4	25	-	1	A-82080	
		Wood	48	3.00	2.20	20	ATB	25.4	25	Economy	1	B-17360	
		Wood	48	3.40	2.40	20	ATB	25.4	25	-	1	A-82096	
		Wood	60	2.80	2.00	20	ATAF	25.4	25	Economy	1	B-17376	
		Wood	60	3.00	2.00	20	ATAF	25.4	25	-	1	A-82105	
		Wood	80	2.60	2.00	15	ATAF	25.4	25	Economy	1	B-17382	
305	★★★	Wood	80	3.20	2.20	15	ATAF	25.4	25	-	1	A-82317	
		Wood	100	3.00	2.20	15	ATAF	25.4	25	-	1	A-82323	
		Wood	120	3.00	2.20	15	ATAF	25.4	25	-	1	A-82339	
		Wood	120	3.00	2.20	15	ATAF	25.4	25	-	1	A-82339	

Outer dia (mm)	Range	Material	No. of teeth	Kerf (mm)	Plate (mm)	Rake	Tooth shape	Bore (mm)	Ring (mm)	Note	Per pkg	Part No.
355	★★★★	Wood	30	3.20	2.40	25	ATB	25.4	25	Economy	1	B-17413
		Wood	30	3.60	2.60	25	ATB	25.4	25	-	1	A-82111
		Wood	36	3.20	2.40	25	ATB	25.4	25	Economy	1	B-17429
		Wood	36	3.60	2.60	25	ATB	25.4	25	-	1	A-82127
		Wood	40	3.20	2.40	25	ATB	25.4	25	Economy	1	B-17435
		Wood	40	3.60	2.60	25	ATB	25.4	25	-	1	A-82133
		Wood	48	3.00	2.20	25	ATB	25.4	25	Economy	1	B-17441
		Wood	48	3.40	2.40	25	ATAF	25.4	25	-	1	A-81527
		Wood	48	3.60	2.60	25	ATB	25.4	25	-	1	A-82731
		Wood	60	3.00	2.20	20	ATB	25.4	25	Economy	1	B-17457
		Wood	60	3.40	2.40	20	ATAF	25.4	25	-	1	A-82149
		Wood	80	3.00	2.20	20	ATAF	25.4	25	Economy	1	B-17463
		Wood	80	3.40	2.40	15	ATAF	25.4	25	-	1	A-82345
		Wood	80	3.40	2.40	20	ATAF	25.4	25	-	1	A-81533
		Wood	100	3.40	2.40	15	ATAF	25.4	25	-	1	A-82351
		Wood	100	3.40	2.40	15	ATB	25.4	-	-	1	A-81549
Wood	120	3.40	2.40	15	ATAF	25.4	25	-	1	A-82367		
405	★★★★	Wood	30	3.20	2.40	25	ATAF	25.4	25	Economy	1	B-17479
		Wood	30	3.80	2.60	25	ATAF	25.4	25	-	1	A-82155
		Wood	36	3.20	2.40	25	ATB	25.4	25	Economy	1	B-17485
		Wood	36	3.60	2.60	25	ATAF	25.4	-	-	1	A-82161
		Wood	40	3.20	2.40	25	ATB	25.4	25	Economy	1	B-17491
		Wood	40	3.60	2.60	25	ATAF	25.4	25	-	1	A-82177
		Wood	48	3.20	2.40	25	ATB	25.4	25	Economy	1	B-17500
		Wood	48	3.60	2.60	25	ATB	25.4	-	-	1	A-81555
		Wood	60	3.00	2.20	20	ATB	25.4	25	Economy	1	B-17516
		Wood	60	3.40	2.40	20	ATAF	25.4	25	-	1	A-82183
		Wood	80	3.00	2.20	20	ATAF	25.4	25	Economy	1	B-17522
		Wood	80	3.60	2.60	20	ATAF	25.4	25	-	1	A-81561
Wood	100	3.60	2.60	15	ATAF	25.4	25	-	1	A-82395		
Wood	120	3.60	2.60	15	ATAF	25.4	25	-	1	A-81577		
510	★★★★	Wood	52	4.20	3.00	25	ATB	25.4	-	-	1	A-81583
		Wood	80	4.20	3.00	20	ATAF	25.4	-	-	1	A-81599
		Wood	120	4.20	3.00	15	ATAF	25.4	-	-	1	A-81608

for MDF



(Circular Saw) & (Plunge Cut Circular Saw)

Outer dia (mm)	Range	Material	No. of teeth	Kerf (mm)	Plate (mm)	Rake	Tooth shape	Bore (mm)	Ring (mm)	Note	Per pkg	Part No.
165	★★★★★	Wood/MDF/Laminate	56	1.45	1.00	23	ATAFR	20	-	EFFICUT	1	B-57364
		Wood/MDF/Laminate	44	1.45	1.00	23	ATAFR	20	-	Coated / Laser Slit Specialized for cordless saws	1	B-53279
		Wood/MDF/Laminate	55	1.60	1.10	20	ATAFR	20	-	Coated / Laser Slit Specialized for cordless saws	1	B-57059
		MDF/Laminate	60	2.00	1.40	5	TCG	20	-	Coated / Laser Slit for Plunge Cut Circular Saw	1	B-56677
		MDF/Laminate	60	2.00	1.40	5	Hi-ATB	20	-	Clean cut Coated / Laser Slit for Plunge Cut Circular Saw	1	B-56661
		MDF/Laminate	52	2.20	1.40	-5	TCG	20	15.88	-	-	1
185	★★	MDF/Laminate	60	2.20	1.50	-5	TCG	20	-	-	1	D-59427
		MDF	60	2.40	1.50	12	TCG	30	20/16	-	1	D-17902
		MDF	60	2.40	1.50	12	ATB	30	20/15.88	Clean cut	1	D-38934
		MDF	60	2.40	1.50	14	TCG	20	15.88	Fast cut	1	D-21381
	★	MDF/Laminate	60	2.20	1.40	-5	TCG	20	15.88	-	1	D-61466 D-61466-10
190	★★★★★	Wood/MDF/Laminate	44	1.45	1.00	23	ATAFR	20	-	Coated / Laser Slit	1	B-54508



(Slide Compound Saw / Miter Saw)

Outer dia (mm)	Range	Material	No. of teeth	Kerf (mm)	Plate (mm)	Rake	Tooth shape	Bore (mm)	Ring (mm)	Note	Per pkg	Part No.
255	★★	MDF/Laminate	84	2.60	1.80	-5	TCG	25.4	-	-	1	D-62452
		MDF/Laminate	100	3.00	2.00	12	ATB	30	15.88	Clean cut	1	D-38940
		MDF/Laminate	100	3.20	2.40	10	TCG	30	15.88	-	1	D-19071
	★	MDF/Laminate	84	2.80	1.80	10	TCG	25.4	-	-	1	D-62480
		MDF/Laminate	100	2.80	1.80	10	TCG	25.4	15.88	-	1	D-72279
260	★	MDF/Laminate	84	2.80	1.80	10	TCG	25.4	15.88	-	1	D-72285
305	★★	MDF/Laminate	96	3.20	2.20	-5	TCG	25.4	-	-	1	D-62468
		MDF/Laminate	120	3.20	2.20	12	ATB	30	15.88	Clean cut	1	D-38956
	MDF/Laminate	120	3.20	2.40	10	TCG	30	15.88	-	1	D-19087	
	★	MDF/Laminate	96	3.00	2.00	10	TCG	25.4	-	-	1	D-62496

**for Metal**

(Metal Cutter)



Outer dia (mm)	Range	Material	No. of teeth	Kerf (mm)	Plate (mm)	Rake	Tooth shape	Bore (mm)	Ring (mm)	Note	Per pkg	Part No.
136	★★★★★	Metal	30	1.10	0.95	0	SMTTCG	20	-	EFFICUT Metal	1	B-69428
		Metal/SUS	45	1.10	0.95	0	SMTTCG	20	-	EFFICUT Metal	1	B-69434
	★★★	Thin sheet metal	50	1.40	1.10	-15	ATB	20	-	-	1	B-07325
		Metal	30	1.50	1.20	0	MTCG	20	-	-	1	B-07319
		Metal/SUS	56	1.10	0.95	0	FTG	20	-	Laser Slit	1	B-23117
150	★★★★★	Metal	33	1.10	0.95	0	SMTTCG	20	-	EFFICUT Metal	1	B-69440
		Metal/SUS	48	1.10	0.95	0	SMTTCG	20	-	EFFICUT Metal	1	B-69456
	★★★	Thin sheet metal	52	1.40	1.10	-15	ATB	20	-	-	1	B-47008
		Metal	32	1.50	1.20	0	MTCG	20	-	-	1	B-46296
		Thick metal	32	1.10	0.95	0	TCG	20	-	Laser Slit	1	B-68301
		Metal/SUS	60	1.10	1.00	0	SMTTCG	20	-	Laser Slit	1	B-47014
185	★★★★★	Metal	45	1.40	1.20	0	SMTTCG	20	-	EFFICUT Metal	1	E-12918
		Metal/SUS	60	1.40	1.20	0	SMTTCG	20	-	EFFICUT Metal	1	E-12924
	★★★	Thin metal	48	1.85	1.50	0	SMTTCG	20	-	Long Life	1	B-23357
		Metal	36	1.90	1.50	0	ATB	20	-	-	1	B-04628
		Metal	38	2.00	1.60	0	MTCG	20	-	-	1	A-85438
		Metal	48	2.00	1.60	0	MTCG	20	-	-	1	A-83967
		Metal	56	1.80	1.50	0	SMTTCG	20	-	Long Life	1	B-23391
		Metal	70	1.70	1.30	-10	FTG	20	-	-	1	A-86446
Thick metal	38	1.40	1.20	0	TCG	20	-	Laser Slit	1	E-14320		



		Metal/SUS	64	1.60	1.30	0	FTG	20	-	Long Life	1	B-31697
--	--	-----------	----	------	------	---	-----	----	---	-----------	---	---------

(Metal Cutting Saw)

Outer dia (mm)	Range	Material	No. of teeth	Kerf (mm)	Plate (mm)	Rake	Tooth shape	Bore (mm)	Ring (mm)	Note	Per pkg	Part No.
305	★★★★★	Metal	63	2.00	1.75	-2	SMTTCG	25.4	-	EFFICUT Metal	1	E-12083
		Metal	60	2.10	1.70	0	TCG	25.4	-	Fast cut	1	A-87242
		Metal	60	2.40	2.00	0	TCG	25.4	-	Laser Slit	1	A-86723
	★★★	Metal	60	2.50	2.20	0	TCG	25.4	-	-	1	A-81860
		Metal	78	2.30	2.00	0	MTCG	25.4	-	Laser Slit	1	A-87127
		Metal/SUS	100	1.95	1.65	-3	SMTTCG	25.4	-	-	1	B-23151
	★★	Metal	60	2.40	2.00	0	TCG	25.4	-	-	1	D-71364

**for Aluminum**



(Circular Saw) & (Plunge Cut Circular Saw) & (Metal Cutter)

Outer dia (mm)	Range	Material	No. of teeth	Kerf (mm)	Plate (mm)	Rake	Tooth shape	Bore (mm)	Ring (mm)	Note	Per pkg	Part No.
136	★★★	Aluminum	50	1.60	1.00	0	ATB	20	-	-	1	B-40331
150	★★★	Aluminum	52	1.60	1.00	0	ATB	20	-	-	1	B-47020
165	★★★★	Aluminum	56	2.00	1.40	-3	TCG	20	-	for Plunge Cut Circular Saw	1	B-56655
	★★★	Aluminum	56	2.40	1.70	-3	TCG	20	-	for Plunge Cut Circular Saw	1	B-07440
185	★	Aluminum	40	2.20	1.40	5	TCG	20	-	-	1	D-62119
		Aluminum	60	2.20	1.40	5	TCG	20	-	-	1	D-73047
210	★	Aluminum	60	2.40	1.60	5	TCG	25	-	-	1	D-73053
235	★	Aluminum	80	2.20	1.40	5	TCG	20	-	-	1	D-73069



(Slide Compound Saw / Miter Saw) & (Metal Cutting Saw)

Outer dia (mm)	Range	Material	No. of teeth	Kerf (mm)	Plate (mm)	Rake	Tooth shape	Bore (mm)	Ring (mm)	Note	Per pkg	Part No.	
165	★★★	Aluminum	60	1.80	1.20	5	TCG	20	-	Laser Slit	1	B-56530	
190	★★★	Aluminum	60	2.00	1.40	-5	TCG	20	-	-	1	B-03997	
255	★★★	Aluminum	100	2.30	1.80	-5	TCG	25.4	25	-	1	B-04204	
		Aluminum	100	2.60	2.00	0	ATB	25.4	25	Clean cut	1	A-81614	
		Aluminum	120	2.60	2.00	0	ATB	25.4	25	Clean cut	1	A-81620	
260	★★★★★	Aluminum	81	1.85	1.50	-3	SMTCG	25.4	-	EFFICUT Aluminum	1	E-06345	
	★★	Aluminum	70	3.00	2.00	5	TCG	25.4	-	-	1	D-03408	
		Aluminum	100	3.00	2.00	5	TCG	25.4	-	-	1	D-03414	
	★	Aluminum	70	2.80	1.80	5	TCG	25.4	-	-	1	D-73075	
		Aluminum	100	2.60	1.80	5	TCG	25.4	-	-	1	D-59162	
		Aluminum	120	2.60	1.80	5	TCG	25.4	-	-	1	D-61058	
305	★★★★★	Aluminum	81	2.00	1.65	-3	SMTCG	25.4	-	EFFICUT Aluminum	1	E-13281	
		Aluminum	96	2.00	1.65	-3	SMTCG	25.4	-	EFFICUT Aluminum	1	E-13340	
	★★★	Aluminum	100	2.40	1.80	5	FTG	25.4	-	-	1	B-02820	
	★★	Aluminum	80	3.00	2.20	5	TCG	30	15.88	-	1	D-16520	
		Aluminum	100	3.00	2.00	5	TCG	25.4	15.88	-	1	D-34419	
	★	Aluminum	80	2.80	2.00	5	TCG	25.4	-	-	-	1	D-73081
		Aluminum	100	2.80	2.00	5	TCG	25.4	-	-	-	1	D-73097
355	★★★	Aluminum	80	3.00	2.20	5	TCG	25	-	-	1	A-02602	
	★★	Aluminum	120	3.30	2.35	8	TCG	30	25	-	1	D-16592	

**for Multi-purpose**



(Circular Saw)

Outer dia (mm)	Range	Material	No. of teeth	Kerf (mm)	Plate (mm)	Rake	Tooth shape	Bore (mm)	Ring (mm)	Note	Per pkg	Part No.
160	★	wood,MDF,aluminum,PVC	60	2.20	1.40	5	TCG	30	20/19/16/15.88	-	1	D-63600
165	★	wood,MDF,aluminum,PVC	60	2.20	1.40	5	TCG	30	20/19/16/15.88	-	1	D-63616
185	★	wood,MDF,aluminum,PVC	60	2.20	1.40	5	TCG	30	20/16/15.88	-	1	D-63622
190	★	wood,MDF,aluminum,PVC	60	2.20	1.40	5	TCG	30	20/16/15.88	-	1	D-63638
210	★	wood,MDF,aluminum,PVC	60	2.40	1.60	5	TCG	30	25.4/25/20/16	-	1	D-63644
235	★	wood,MDF,aluminum,PVC	60	2.40	1.60	5	TCG	30	25.4/25/20/16	-	1	D-63557



(Slide Compound Saw / Miter Saw)

Outer dia (mm)	Range	Material	No. of teeth	Kerf (mm)	Plate (mm)	Rake	Tooth shape	Bore (mm)	Ring (mm)	Note	Per pkg	Part No.
216	★	wood,MDF,aluminum,PVC	60	2.40	1.60	5	TCG	30	25.4/25/20/16	-	1	D-63650
		wood,MDF,aluminum,PVC	80	2.40	1.60	5	TCG	30	25.4/25/20/16	-	1	D-63878
260	★	wood,MDF,aluminum,PVC	80	2.60	1.80	5	TCG	30	25.4/25/20/16	-	1	D-63563
		wood,MDF,aluminum,PVC	100	2.60	1.80	5	TCG	30	25.4/25/20/16	-	1	D-62234
		wood,MDF,aluminum,PVC	120	2.60	1.80	5	TCG	30	25.4/25/20/16	-	1	D-62240
305	★	wood,MDF,aluminum,PVC	80	2.80	2.00	5	TCG	30	25.4/25/20/16	-	1	D-63579
		wood,MDF,aluminum,PVC	100	2.80	2.00	5	TCG	30	25.4/25/20/16	-	1	D-63585
		wood,MDF,aluminum,PVC	120	2.80	2.00	5	TCG	30	25.4/25/20/16	-	1	D-63591
355	★	wood,MDF,aluminum,PVC	100	3.00	2.20	5	TCG	30	25.4/25/20/16	-	1	D-63884

**for Other**

(Circular Saw) &amp; (Plunge Cut Circular Saw)

Outer dia (mm)	Range	Material	No. of teeth	Kerf (mm)	Plate (mm)	Rake	Tooth shape	Bore (mm)	Ring (mm)	Note	Per pkg	Part No.
165	★★★★	CORIAN®	48	2.00	1.40	5	TCG	20	-	-	1	B-56683
	★★★	Sandwichpanel	42	1.75	1.40	0	SMTCG	20	-	-	1	B-63161
		CORIAN®	48	2.40	1.70	5	TCG	20	-	-	1	B-10344
	★★	Fiber Cement Board	4	1.80	1.40	12	FTG	20	15.88	-	1	D-72104
185	★★★★★	Composite deck	40	1.50	1.00	15	ATAFR	20	-	EFFICUT Composite decking	1	E-11972
	★★	Fiber Cement Board	4	1.80	1.40	12	FTG	20	15.88	-	1	D-72110



(Slide Compound Saw / Miter Saw)

Outer dia (mm)	Range	Material	No. of teeth	Kerf (mm)	Plate (mm)	Rake	Tooth shape	Bore (mm)	Ring (mm)	Note	Per pkg	Part No.
260	★★★★★	Composite deck	75	2.15	1.65	8	ATAFR	25.4	-	EFFICUT Composite decking	1	E-11988
	★★	Fiber Cement Board	6	2.20	1.60	12	FTG	25.4	15.88	-	1	D-72126
305	★★	Fiber Cement Board	8	2.40	1.80	12	FTG	25.4	-	-	1	D-72132

**Specialized for Aluminum Groove Cutter (CA5000)**

Outer dia (mm)	Range	Material	No. of teeth	Kerf (mm)	Plate (mm)	Rake	Tooth shape	Bore (mm)	Ring (mm)	Note	Per pkg	Part No.
118	Specialized	Aluminium composite panel	6	14.00	6.00	5	TCG	20	-	Grooving 90 degrees for Aluminum Groove Cutter	1	B-48832
		Aluminium composite panel	6	18.00	6.00	5	TCG	20	-	Grooving 135 degrees for Aluminum Groove Cutter	1	B-48860

**Specialized for Cordless Steel Rod Cutter (DSC251)**

Outer dia (mm)	Range	Material	No. of teeth	Kerf (mm)	Plate (mm)	Rake	Tooth shape	Bore (mm)	Ring (mm)	Note	Per pkg	Part No.
110	★★★★★	Metal	24	1.50	1.10	0	SMTCG	34	-	EFFICUT Metal for Cordless Steel Rod Cutter	1	E-11097

# ACCESSORIES

## ▣ Jigsaw / Reciprosawing

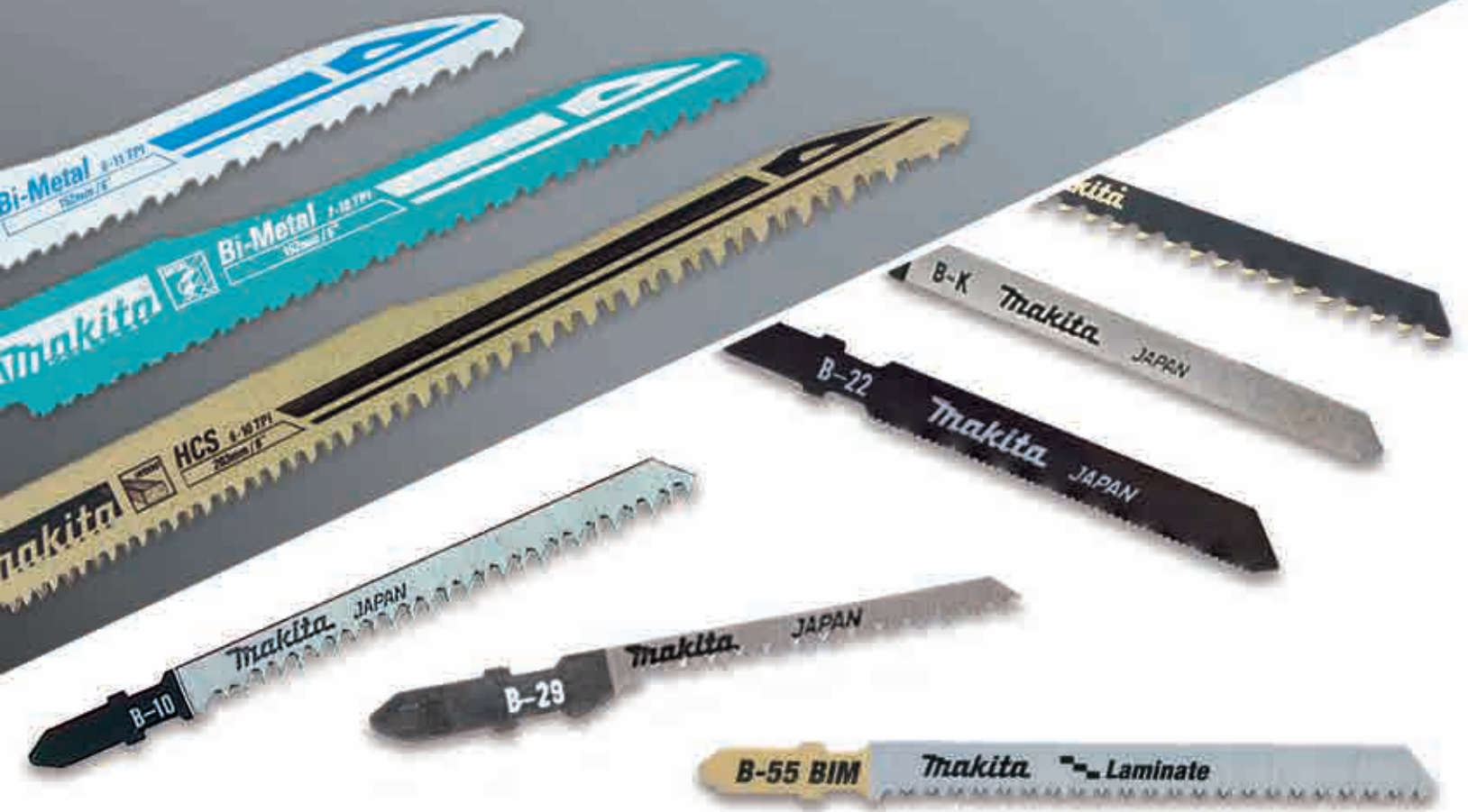

Metal, mild steel



Stainless steel



Cast iron



Aluminum



Non-ferrous metal



Wood



Wood with nails



Chipboard



Laminate board



Fiber cement board



Aerated concrete



Plastic



Fiberglass



Plaster board



HCS



Bi-Metal



Wave



Straight Raker

# Jig Saw blade

## Teeth Type

Milled and side set teeth

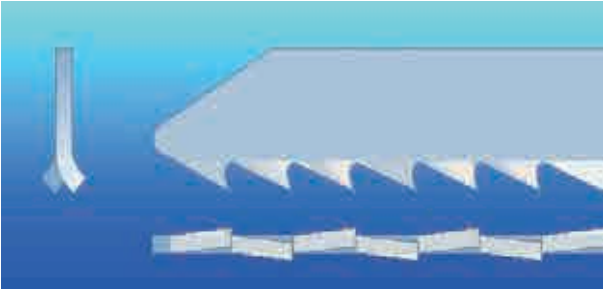

Ground and side set teeth



Milled and wavy set teeth



Ground and taper ground teeth

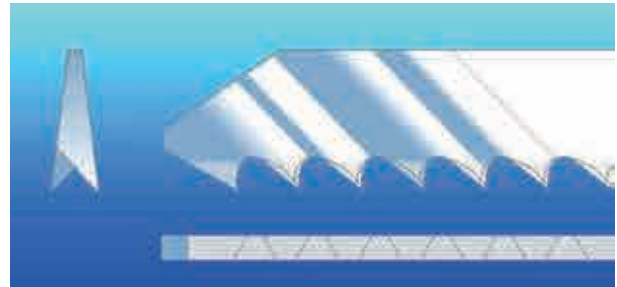

## Teeth manufacture

### Milled teeth

- Low cost type of manufacturing
- For general cutting
- Soft to hard materials
- Long blade life



### Ground teeth

- Costly type of manufacturing
- Very sharp!
- Accurate, clean cut
- Soft to medium hard materials

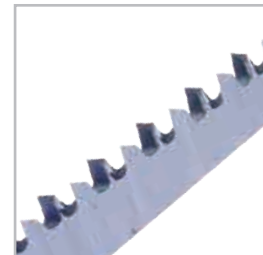

## Production method

- **Side set:** each individual tooth is alternately bent to the left and to the right. Raker setting  
Example: right, left, straight, etc. 
- **Wavy set:** row of teeth receives a wave shape
- **Ground:** blade body tapers to the rear (conical)

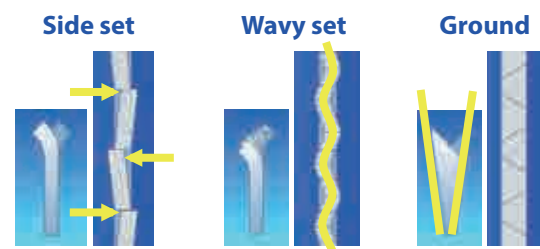

## Jig Saw Blade material

- **HCS (High Carbon Steel)** for cutting softer materials such as wood or plastics.
- **HSS (High Speed Steel)** for cutting harder materials such as metals.
- **BiM (Bi-metal, HCS base and HSS teeth)** for cutting soft materials to hard materials such as wood, metal, plastics.
- **TC (Tungsten Carbide)** for cutting glass fiber reinforced plastic, cement-bonded fiberboards or plasterboard.

**Jig saw blade B shank Wood Super express**



Makita No.	Material	Type of cut	TPI	Overall Length mm	Working Length mm	Thickness mm	Material of Blade	Range	Sales Pkg Qty	Part No.
B-50	Wood, Plastics	Fast finish	8-11	100	73	1.25	HCS	★★★	5	B-06460

**Jig saw blade B shank Metal Super express**



Makita No.	Material	Type of cut	TPI	Overall Length mm	Working Length mm	Thickness mm	Material of Blade	Range	Sales Pkg Qty	Part No.
B-51	Metal, Stainless	Fast	10-18	100	73	0.8	HSS	★★★	5	B-06476

**Jig saw blade B shank Universal Super express**



Makita No.	Material	Type of cut	TPI	Overall Length mm	Working Length mm	Thickness mm	Material of Blade	Range	Sales Pkg Qty	Part No.
B-52	Universal	Fast	6-10	100	73	1.0	HSS	★★★	5	B-06482

**Jig saw blade B shank Super express assortment**



Note	Range	Sales Pkg Qty	Part No.
B-50, B-51, B-52	★★★	3	B-06292

**Jig saw blade B shank Wood Basic**

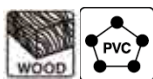

Makita No.	Material	Type of cut	TPI	Overall Length mm	Working Length mm	Thickness mm	Material of Blade	Range	Sales Pkg Qty	Part No.
B-13	Wood, Plastics	Basic	8	105	75	1.25	HCS	★★★	2	B-01286
									5	A-85656
									100	B-07705
B-15	Wood, Plastics	Basic	12	76	50	1.05	HCS	★★★	5	A-85678
B-14	Wood, Plastics	Basic	18	76	51	1.05	HCS	★★★	5	A-85662
B-18	Wood, Plastics	Basic, Scroll cutting	14	77	44	1.05	HCS	★★★	5	A-85709
									100	B-07727

**Jig saw blade B shank Wood Basic Price competitive**



Material	Type of cut	TPI	Overall Length mm	Working Length mm	Thickness mm	Material of Blade	Range	Sales Pkg Qty	Part No.
Wood	Basic	8	100	74	1.2	HCS	★★	5	D-34877

### Jig saw blade B shank Wood Fast



Makita No.	Material	Type of cut	TPI	Overall Length mm	Working Length mm	Thickness mm	Material of Blade	Range	Sales Pkg Qty	Part No.
B-16	Wood, Plastics	Fast	6	105	75	1.25	HCS	★★★	2	B-01292
									5	A-85684
									100	B-07711
L-2	Wood, Plastics	Fast	6	132	101	1.25	HCS	★★★	5	A-86309
B-16L	Wood, Plastics	Fast	6	180	151	1.25	HCS	★★★	5	792726-5
B-8	Wood, Plastics	Fast	8	105	75	1.25	HCS	★★★	5	A-85232
No.58	Wood, Plastics	Fast	8	105	75	1.25	HCS	★★★	5	A-86577
									100	B-07842
B-17	Wood, Plastics	Fast, Scroll cutting	6	105	71	1.25	HCS	★★★	2	B-01301
									5	A-85690

### Jig saw blade B shank Wood Fast Price competitive



Material	Type of cut	TPI	Overall Length mm	Working Length mm	Thickness mm	Material of Blade	Range	Sales Pkg Qty	Part No.
Wood	Fast	6	100	74	1.2	HCS	★★	5	D-34883
Wood	Fast, Scroll cutting	6	100	74	1.2	HCS	★★	5	D-34899

### Jig saw blade B shank Wood Finish



Makita No.	Material	Type of cut	TPI	Overall Length mm	Working Length mm	Thickness mm	Material of Blade	Range	Sales Pkg Qty	Part No.
BR-13	Wood	Finish	9	105	70	1.25	HCS	★★★	5	A-85793
									100	B-07777
B-10S	Wood	Finish	12	90	65	1.25	HCS	★★★	5	792691-8
L-1	Wood, Plastics	Finish	6	132	100	1.25	HCS	★★★	5	A-86290
B-12	Wood, Plastics	Fast finish	6	105	74	1.25	HCS	★★★	5	A-85640
									100	B-07696
No.59	Wood, Plastics	Fast finish	8	105	75	1.25	HCS	★★★	5	A-86583
									100	B-07858
B-11	Wood, Plastics	Fast finish	9	100	73	1.25	HCS	★★★	2	B-01270
									5	A-85634
									100	B-07680
B-10	Wood, Plastics	Fast finish	9	105	76	1.25	HCS	★★★	5	A-85628
									100	B-07674
B-29	Wood, Plastics	Finish, Scroll cutting	16	77	44	1.05	HCS	★★★	5	A-80400
									100	B-07761

### Jig saw blade B shank Wood Finish Price competitive



Material	Type of cut	TPI	Overall Length mm	Working Length mm	Thickness mm	Material of Blade	Range	Sales Pkg Qty	Part No.
Wood	Finish	9	100	74	1.2	HCS	★★	5	D-72718

**Jig saw blade B shank Hardwood and Hard plastics Basic**



Makita No.	Material	Type of cut	TPI	Overall Length mm	Working Length mm	Thickness mm	Material of Blade	Range	Sales Pkg Qty	Part No.
B-25	Wood, Plastics, Aluminum, Metal	Basic	9	100	74	1.05	HSS	★★★	2	B-01345
									5	A-85765
									100	B-07755
B-26	Wood, Plastics, Aluminum, Metal	Basic, Scroll cutting	9	100	71	1.05	HSS	★★★	2	B-01351
									5	A-85771

**Jig saw blade B shank Decorative veneers Finish**



Makita No.	Material	Type of cut	TPI	Overall Length mm	Working Length mm	Thickness mm	Material of Blade	Range	Sales Pkg Qty	Part No.
B-19	Wood, Plastics	Finish	12	90	63	1.25	HCS	★★★	5	A-85715
B-28	Wood, Plastics	Finish	16	90	63	1.25	HSS	★★★	5	A-80391

**Jig saw blade B shank Laminate Finish**



Makita No.	Material	Type of cut	TPI	Overall Length mm	Working Length mm	Thickness mm	Material of Blade	Range	Sales Pkg Qty	Part No.
B-55	Laminate, Plastics	Finish	14	100	77	1.25	Bi-Metal	★★★	5	B-31887
B-53	Laminate, Plastics	Finish	15	82	59	1.25	Bi-Metal	★★★	5	B-10970
B-54	Laminate, Plastics	Finish, Scroll cutting	18	82	59	1.25	Bi-Metal	★★★	5	B-10986

**Jig saw blade B shank Metal Basic**



Makita No.	Material	Type of cut	TPI	Overall Length mm	Working Length mm	Thickness mm	Material of Blade	Range	Sales Pkg Qty	Part No.
B-34	Metal, Stainless, Plastics, Aluminum	Basic	18	76	52	0.9	HSS	★★★	5	B-10453
B-22	Metal, Stainless, Plastics, Aluminum	Basic	24	76	52	0.9	HSS	★★★	2	B-01323
									5	A-85737
									100	B-07733
No.51	Metal, Stainless, Plastics, Aluminum	Basic	24	90	66	0.9	HSS	★★★	5	A-86561
									100	B-07836
B-24	Metal, Stainless, Plastics, Aluminum	Basic	32	76	52	0.9	HSS	★★★	5	A-85759
B-27	Metal, Stainless, Plastics, Aluminum	Basic, Scroll cutting	24	76	52	0.9	HSS	★★★	2	B-01367
									5	A-85787
B-33	Metal, Plastics, Aluminum	Basic	14	132	107	1.25	HSS	★★★	5	B-10447
B-32	Metal, Plastics, Aluminum	Basic	18	132	107	1.25	HSS	★★★	5	B-10431
									2	B-01339
									5	A-85743
B-23	Wood, Plastics, Aluminum, Metal	Basic	14	76	51	0.9	HSS	★★★	5	A-85743
									100	B-07749
B-35	Wood with nails, Plastic, Aluminum	Basic	14	180	154	0.9	Bi-Metal	★★★	3	B-10469

**Jig saw blade B shank Metal Basic Price competitive**



Material	Type of cut	TPI	Overall Length mm	Working Length mm	Thickness mm	Material of Blade	Range	Sales Pkg Qty	Part No.
Metal	Basic	21	75	51	1	HSS	★★	5	D-34908

### Jig saw blade B shank Plastics



Makita No.	Material	TPI	Overall Length mm	Working Length mm	Thickness mm	Material of Blade	Range	Sales Pkg Qty	Part No.
B-21	Plastics, Aluminum	12	100	73	1.25	HSS	★★★	2	B-01317
								5	A-85721

### Jig saw blade B shank Fiber cement



Makita No.	Material	TPI	Overall Length mm	Working Length mm	Thickness mm	Material of Blade	Range	Sales Pkg Qty	Part No.
B-60	Fiber cement, Plaster board, FRP, Plastics	6	100	75	1.25	TC/HM	★★★	3	B-06890
B-61	Fiber cement, Plaster board, FRP, Plastics	6	132	105	1.25	TC/HM	★★★	3	B-06909

### Jig saw blade B shank Rubber



Makita No.	Material	Overall Length mm	Working Length mm	Thickness mm	Material of Blade	Range	Sales Pkg Qty	Part No.
B-K	Rubber, Paper, Cork, Leather	100	75	1.25	HCS	★★★	5	A-80416

### Jig saw blade B shank assortment

Note	Range	Sales Pkg Qty	Part No.
B-10S, B-13, B-16, B-22, B-23	★★★	5	A-86898
B-50, B-51, B-52, B-53	★★★	5	B-48527
B-13, B-16, B-10S, B-22, B-23	★★★	10	B-44410
B-50, B-51, B-52, B-53	★★★	10	B-44426

### Jig saw blade M shank Wood Basic



Makita No.	Material	Type of cut	TPI	Overall Length mm	Working Length mm	Thickness mm	Material of Blade	Range	Sales Pkg Qty	Part No.
No.3	Wood, Plastics	Basic	9	80	59	1	HCS	★★★	2	A-86533
									5	A-85868
									100	B-07808
No.16	Wood, Plastics	Basic, Scroll cutting	9	82	61	1.25	HCS	★★★	2	792212-6
									5	A-85830

### Jig saw blade M shank Wood Fast



Makita No.	Material	Type of cut	TPI	Overall Length mm	Working Length mm	Thickness mm	Material of Blade	Range	Sales Pkg Qty	Part No.
No.8	Wood, Plastics	Fast	8	82	60	1	HCS	★★★	2	792267-1
									5	A-85911
									100	B-07814

**Jig saw blade M shank Wood Finish**



Makita No.	Material	Type of cut	TPI	Overall Length mm	Working Length mm	Thickness mm	Material of Blade	Range	Sales Pkg Qty	Part No.
BR-3	Wood	Finish	9	85	58	1	HCS	★★★	5	A-85933
No.10S	Wood	Finish	13	82	62	1.25	HCS	★★★	2	A-86555
									5	A-85824
No.9	Wood, Plastics	Fast finish	8	82	60	1.25	HCS	★★★	2	792325-3
									5	A-85927
No.10	Wood, Plastics	Fast finish	9	82	60	1.25	HCS	★★★	2	792326-1
									5	A-85818
									100	B-07820

**Jig saw blade M shank Hardwood and Hard plastics Basic**



Makita No.	Material	Type of cut	TPI	Overall Length mm	Working Length mm	Thickness mm	Material of Blade	Range	Sales Pkg Qty	Part No.
No.4	Wood, Plastics, Aluminum, Metal	Basic	9	80	59	0.9	HSS	★★★	2	A-86549
									5	A-85874

**Jig saw blade M shank Decorative veneers Basic**



Makita No.	Material	Type of cut	TPI	Overall Length mm	Working Length mm	Thickness mm	Material of Blade	Range	Sales Pkg Qty	Part No.
No.2	Wood, Plastics, Aluminum, Metal	Basic	14	80	60	0.9	HSS	★★★	2	A-86527
									5	A-85852
									100	B-07799
No.17	Wood, Plastics, Aluminum, Metal	Basic, Scroll cutting	14	82	63	0.9	HSS	★★★	2	792215-0
									5	A-85846

**Jig saw blade M shank Decorative veneers Finish**



Makita No.	Material	Type of cut	TPI	Overall Length mm	Working Length mm	Thickness mm	Material of Blade	Range	Sales Pkg Qty	Part No.
No.41	Wood, Plastics	Finish	12	82	61	1.25	HSS	★★★	5	A-85880
No.42	Wood, Plastics	Finish	16	82	61	1.25	HSS	★★★	5	A-85896

**Jig saw blade M shank Metal Basic**



Makita No.	Material	Type of cut	TPI	Overall Length mm	Working Length mm	Thickness mm	Material of Blade	Range	Sales Pkg Qty	Part No.
No.1	Metal, Stainless, Plastics, Aluminum	Basic	24	80	61	0.9	HSS	★★★	2	A-86511
									5	A-85802
									100	B-07783
No.5	Metal, Plastics, Aluminum	Basic	24	60	40	0.9	HSS	★★★	2	792131-6
									5	A-85905

**Jig saw blade M shank assortment**

Note	Range	Sales Pkg Qty	Part No.
No.1, No.2, No.3, No.8, No.10S	★★★	5	A-86882

### Recipro saw blade Metal Super express



**SUPEREXPRESS**



Material	Type of cut	TPI	Overall Length mm	Working Length mm	Thickness mm	Material of Blade	Range	Sales Pkg Qty	Part No.
Metal, Plastics	Fast	7-18	152	130	0.9	Bi-Metal	★★★	2	B-05038-2
								5	B-05038
								25	B-05038-25

### Recipro saw blade Wood Super express



**SUPEREXPRESS**



Material	Type of cut	TPI	Overall Length mm	Working Length mm	Thickness mm	Material of Blade	Range	Sales Pkg Qty	Part No.
Wood	Fast	6-10	203	180	1.0	HCS	★★★	2	B-05153-2
								5	B-05153
								25	B-05153-25

### Recipro saw blade Universal Super express



**SUPEREXPRESS**



Material	Type of cut	TPI	Overall Length mm	Working Length mm	Thickness mm	Material of Blade	Range	Sales Pkg Qty	Part No.
Universal	Fast	6-11	152	130	0.9	Bi-Metal	★★★	2	B-05044-2
								5	B-05044
								25	B-05044-25

### Recipro saw blade Metal Basic



Material	Type of cut	TPI	Overall Length mm	Working Length mm	Thickness mm	Material of Blade	Range	Sales Pkg Qty	Part No.
Metal	Basic	14	100	80	0.9	Bi-Metal	★★★	5	B-20410
								2	B-16841-2
Metal	Basic	14	152	130	0.9	Bi-Metal	★★★	5	B-16841
								25	B-16841-25
								2	B-16776-2
Metal	Basic	14	225	205	0.9	Bi-Metal	★★★	5	B-16776
								25	B-16776-25
								2	B-20404
Metal	Basic	18	100	80	0.9	Bi-Metal	★★★	5	B-20404
								2	B-05169-2
								5	B-05169
Metal	Basic	18	152	130	0.9	Bi-Metal	★★★	25	B-05169-25
								2	B-00810
								5	792147-1
Metal	Basic	18	165	144	0.9	HSS	★★★	2	B-16782-2
								5	B-16782
								25	B-16782-25
Metal	Basic	18	225	205	0.9	Bi-Metal	★★★	5	B-16782
								25	B-16782-25
								5	B-20395
Metal	Basic	24	100	80	0.9	Bi-Metal	★★★	5	B-20395
								2	B-00804
								5	792146-3
Metal	Basic	24	125	104	0.9	HSS	★★★	2	B-00804
								5	792146-3
								2	B-16835-2
Metal	Basic	24	152	130	0.9	Bi-Metal	★★★	5	B-16835
								2	B-00832
								5	792149-7
Metal	Basic	24	165	144	0.9	HSS	★★★	2	B-00832
								5	792149-7
								2	B-43169-2
Metal	Basic	24	225	205	0.9	Bi-Metal	★★★	5	B-43169
								2	B-16857-2
								2	B-16857
Metal, Aluminum, Plastics	Basic	10-14	305	280	0.9	Bi-Metal	★★★	2	B-16857-2
								2	B-16857

## Recipro saw blade Metal Basic Price competitive



Material	Type of cut	TPI	Overall Length mm	Working Length mm	Thickness mm	Material of Blade	Range	Sales Pkg Qty	Part No.
Metal	Basic	14	150	128	0.9	Bi-Metal	★★	2	D-51627
								25	D-51627-25
Metal	Basic	14	225	204	0.9	Bi-Metal	★★	2	D-51655
								25	D-51655-25
Metal	Basic	18	150	128	0.9	Bi-Metal	★★	2	D-51633
								25	D-51633-25
Metal	Basic	18	225	204	0.9	Bi-Metal	★★	2	D-51661
								25	D-51661-25
Metal	Basic	24	150	128	0.9	Bi-Metal	★★	2	D-51649
								25	D-51649-25
Metal	Basic	24	225	204	0.9	Bi-Metal	★★	2	D-51677
								25	D-51677-25

## Recipro saw blade Metal Curved shape



Material	TPI	Overall Length mm	Working Length mm	Thickness mm	Material of Blade	Range	Sales Pkg Qty	Part No.
Metal	14+18	152	130	1.1	Bi-Metal	★★★	5	B-55815
Metal	14+18	228	205	1.1	Bi-Metal	★★★	5	B-55821
Metal	14+18	305	280	1.1	Bi-Metal	★★★	5	B-55837

## Recipro saw blade Metal Heavy



Material	Type of cut	TPI	Overall Length mm	Working Length mm	Thickness mm	Material of Blade	Range	Sales Pkg Qty	Part No.
Metal	Heavy	14+18	152	130	1.1	Bi-Metal	★★★	5	B-43131
Metal	Heavy	14+18	225	205	1.1	Bi-Metal	★★★	5	B-43175
Metal	Heavy	14-18	225	205	1.1	Bi-Metal	★★★	5	B-31865
Metal	Heavy	14+18	305	280	1.1	Bi-Metal	★★★	5	B-43206
Metal	Heavy fast	8+10	152	130	1.1	Bi-Metal	★★★	5	B-43147
								2	B-43181-2
Metal	Heavy fast	8+10	225	205	1.1	Bi-Metal	★★★	5	B-43181
								2	B-43212-2
Metal	Heavy fast	8+10	305	280	1.1	Bi-Metal	★★★	5	B-43212
								5	B-43153
Metal	Heavy finish	10-14	152	130	1.25	Bi-Metal	★★★	5	B-43153
Metal	Heavy finish	10-14	225	205	1.25	Bi-Metal	★★★	2	B-43197-2
								5	B-43197
Metal	Heavy finish	10-14	305	280	1.25	Bi-Metal	★★★	5	B-43228

## Recipro saw blade Wood Basic



Material	Type of cut	TPI	Overall Length mm	Working Length mm	Thickness mm	Material of Blade	Range	Sales Pkg Qty	Part No.
Wood	Basic	3	152	130	1.25	HCS	★★★	5	B-16813
Wood	Basic	6	152	130	1.25	HCS	★★★	5	B-16798
								2	B-16829-2
Wood	Basic	6	305	280	1.25	HCS	★★★	5	B-16829
								2	B-00826
Wood	Basic	9	165	144	1	HCS	★★★	5	792148-9
Wood	Basic	9	165	144	1	HCS	★★★	5	A-02319
Wood	Basic	10	152	129	1	HCS	★★★	5	B-16807
Wood	Basic	10	152	130	0.8	HCS	★★★	5	B-16807
Wood	Basic	10	250	229	1.25	HCS	★★★	5	B-00767
Green tree, wood	Basic	5	305	280	1.5	HCS	★★★	5	B-16863

**Recipro saw blade Wood Basic Price competitive**



Material	Type of cut	TPI	Overall Length mm	Working Length mm	Thickness mm	Material of Blade	Range	Sales Pkg Qty	Part No.
Wood	Basic	6	150	131	1.2	HCS	★★	2	D-53089

**Recipro saw blade Wood Fast**



Material	Type of cut	TPI	Overall Length mm	Working Length mm	Thickness mm	Material of Blade	Range	Sales Pkg Qty	Part No.
Wood	Fast	4	150	129	1	HCS	★★★	5	A-02303
Wood	Fast	6	300	279	1.25	HCS	★★★	5	B-03030
Wood	Fast finish	6	150	129	1	HCS	★★★	5	792707-9

**Recipro saw blade Wood Japanese teeth**



**1. Japanese teeth for Sharp Edge!**

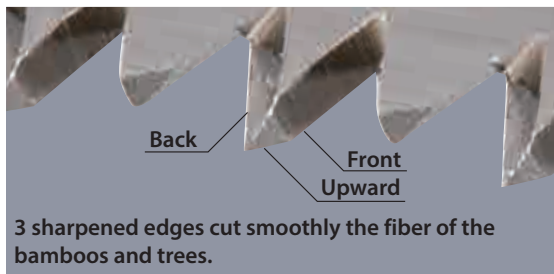

**2. Clean Cutting Surface**

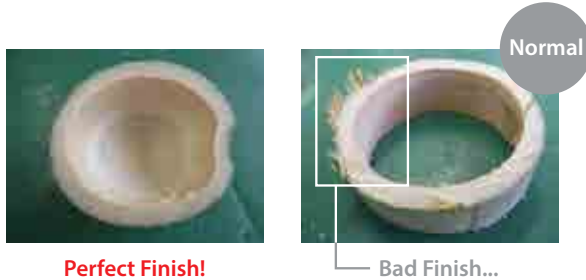

**Application**

**For Bamboo**

**15TPI**

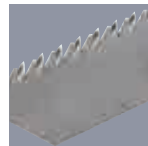

**For Green tree**

**8.5TPI**

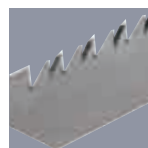

Material	Type of cut	TPI	Overall Length mm	Working Length mm	Thickness mm	Material of Blade	Range	Sales Pkg Qty	Part No.
Bamboo, Wood, Plastic	DC only	15	190	165	0.6	HCS	★★★	1	B-56596
Bamboo, Wood, Plastic	-	15	225	200	0.9	Bi-Metal	★★★	1	B-57392
Green tree, Wood	DC only	8.5	190	165	0.6	HCS	★★★	1	B-56580
Green tree, Wood	-	8.5	225	200	0.9	Bi-Metal	★★★	1	B-57386
Green tree, Wood	-	8.5	250	225	1	HCS	★★★	1	B-62016

**Recipro saw blade Wood and Metal Basic**



Material	Type of cut	TPI	Overall Length mm	Working Length mm	Thickness mm	Material of Blade	Range	Sales Pkg Qty	Part No.
Wood with nails	Basic	6	100	80	0.9	Bi-Metal	★★★	2	B-20432-2
								5	B-20432
Wood with nails	Basic	6	152	130	1.25	Bi-Metal	★★★	2	B-05175-2
								5	B-05175
Wood, Wood with nails, Metal	Basic	10	152	130	0.9	Bi-Metal	★★★	2	B-31843-2
								5	B-31843

Material	Type of cut	TPI	Overall Length mm	Working Length mm	Thickness mm	Material of Blade	Range	Sales Pkg Qty	Part No.
Wood, Wood with nails, Metal	Basic	10	200	180	0.9	Bi-Metal	★★★	200	B-54259
								200	B-54265
Wood, Wood with nails, Metal	Basic	10	225	205	0.9	Bi-Metal	★★★	2	B-31859-2
								5	B-31859
								200	B-54271
								200	B-54287
								5	B-20426
Wood, Metal	Basic	10	100	80	0.9	Bi-Metal	★★★	5	B-20426
Wood, Metal	Basic	14+18	100	80	0.9	Bi-Metal	★★★	5	B-20454
Wood, Plastics, Aluminum, Metal	Basic	10-14	152	130	0.9	Bi-Metal	★★★	5	B-43240
Wood, Plastics, Aluminum, Metal	Basic	10-14	225	205	0.9	Bi-Metal	★★★	5	B-43262
Wood, Chipboard, Wood with nails, Metal, Aerated concrete, Plastics, FRP	Basic	5-8	305	280	1.25	Bi-Metal	★★★	3	B-10637

**Recipro saw blade Wood and Metal Heavy**



Material	Type of cut	TPI	Overall Length mm	Working Length mm	Thickness mm	Material of Blade	Range	Sales Pkg Qty	Part No.
Wood, Chipboard, Metal	Heavy	5-8	152	130	1.6	Bi-Metal	★★★	5	B-43234
Wood, Chipboard, Metal	Heavy	5-8	225	205	1.6	Bi-Metal	★★★	2	B-43256-2
							★★★	5	B-43256
Wood, Chipboard, Metal	Heavy	5-8	305	280	1.6	Bi-Metal	★★★	2	B-43278-2
							★★★	5	B-43278
Wood, Chipboard, Wood with nails, Metal, Plastics, FRP	Heavy	6-8	152	130	1.25	TC/HM	★★★★	1	B-49834
							★★★★	10	B-49834-10
Wood, Chipboard, Wood with nails, Metal, Plastics, FRP	Heavy	6-8	228	205	1.25	TC/HM	★★★★	1	B-49840
							★★★★	10	B-49840-10
Wood, Chipboard, Wood with nails, Metal, Plastics, FRP	Heavy	6-8	305	280	1.25	TC/HM	★★★★	1	B-49856
							★★★★	10	B-49856-10

**Recipro saw blade Wood and Metal Rescue**

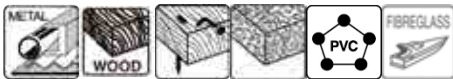

Material	Type of cut	TPI	Overall Length mm	Working Length mm	Thickness mm	Material of Blade	Range	Sales Pkg Qty	Part No.
Wood, Chipboard, Wood with nails, Metal, Plastics, FRP	Heavy	6-8	152	130	1.25	TC/HM	Specialized	25	B-67206
Wood, Chipboard, Wood with nails, Metal, Plastics, FRP	Heavy	6-8	225	205	1.25	TC/HM	Specialized	25	B-67212

**Recipro saw blade Cast iron pipes**

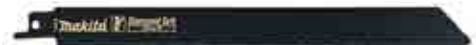

**Tungsten Carbide Tip**

**Application**



Material	TPI	Overall Length mm	Working Length mm	Thickness mm	Material of Blade	Range	Sales Pkg Qty	Part No.
Metal, Cast iron, Stainless	8	100	80	1.25	TC/HM	★★★★★	1	B-55566
						★★★★★	1	B-55572
Metal, Cast iron, Stainless	8	150	130	1.25	TC/HM	★★★★★	10	B-55572-10
						★★★★★	1	B-55588
Metal, Cast iron, Stainless	8	228	205	1.25	TC/HM	★★★★★	10	B-55588-10
						★★★★★	1	B-55594
Metal, Cast iron, Stainless	8	305	280	1.25	TC/HM	★★★★★	10	B-55594-10
						★★★★★	2	B-31871
Cast iron, FRP, Epoxy	-	225	205	1	Diamond Grit	★★★	2	B-31871

## Recipro saw blade Stainless steel



Material	TPI	Overall Length mm	Working Length mm	Thickness mm	Material of Blade	Range	Sales Pkg Qty	Part No.
Stainless	18	152	128	1	TC/HM	★★★	2	B-07250
Stainless	18	203	180	1	TC/HM	★★★	2	B-51312

## Recipro saw blade Fiber insulation



Material	Overall Length mm	Working Length mm	Thickness mm	Material of Blade	Range	Sales Pkg Qty	Part No.
Fiber Insulation	228	205	1.5	HCS	Specialized	2	B-52118
Fiber Insulation	305	280	1.5	HCS	Specialized	2	B-52124
Fiber Insulation	400	320	1.5	HCS	Specialized	1	B-52130

## Recipro saw blade Plasterboard Basic



Material	Type of cut	TPI	Overall Length mm	Working Length mm	Thickness mm	Material of Blade	Range	Sales Pkg Qty	Part No.
Plasterboards	Basic	6	100	80	0.9	Bi-Metal	★★★	5	B-20448

## Recipro saw blade Ice



Material	Type of cut	TPI	Overall Length mm	Working Length mm	Thickness mm	Material of Blade	Range	Sales Pkg Qty	Part No.
Ice	Basic	10	228	207	1.2	Stainless steel	Specialized	1	B-30570
Ice	Basic	10	305	279	1.2	Stainless steel	Specialized	1	B-23254
Ice	Rough	3	305	280	1.25	Stainless steel	Specialized	1	B-10609
Ice	Rough	6	152	131	1.2	Stainless steel	Specialized	1	B-52043
Ice	Rough	6	228	207	1.2	Stainless steel	Specialized	1	B-30564
Ice	Rough	6	305	279	1.2	Stainless steel	Specialized	1	B-23248

## Recipro saw blade Aerated concrete



Material	TPI	Overall Length mm	Working Length mm	Thickness mm	Material of Blade	Range	Sales Pkg Qty	Part No.
Aerated concrete, Soft brick	2	240	202	1.5	TC/HM	★★★	1	B-12809
Aerated concrete, Soft brick	2	305	267	1.5	TC/HM	★★★	1	B-10394
Aerated concrete, Soft brick	2	455	420	1.5	TC/HM	★★★	1	B-10403
Aerated concrete, Soft brick, Epoxy	3	305	280	1.5	TC/HM	★★★	2	B-63585
Aerated concrete, Soft brick, Epoxy	2	400	375	1.5	TC/HM	★★★	2	B-63591

## Recipro saw blade assortment



Note	Range	Sales Pkg Qty	Part No.
B-00804, B-00810, B-00826	★★★	3	792003-5
B-05038, B-05044, B-05153	★★★	3	B-13677
2xB-05044, 2xB-16782, 2xB-16776	★★★	6	B-44448
2xB-16798, 2xB-05153, 2xB-05175	★★★	6	B-44432

## Recipro saw blade Price competitive assortment

Note	Range	Sales Pkg Qty	Part No.
2xD-51627, 2xD-51633, 2xD-53089	Two-star	6	D-53051

**Band saw blade for 730mm Metal Wave type**

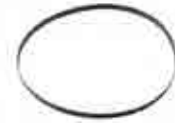
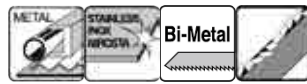

Length mm	Tooth Type	Material	Material of Blade	Tpi	Note	Range	Sales Pkg Qty	Part No.
730	Wave set	Plastics, Non-ferrous metal, Mild steel, Cast steel and cast iron, Hard steel and stainless steel	BiM	14	Material thickness:More than 5mm	★★★	5	E-04101
				18	Material thickness:4-5mm	★★★	5	E-04117
				24	Material thickness:Less than 4mm	★★★	5	E-04123

**Band saw blade for 835mm Metal Wave type**

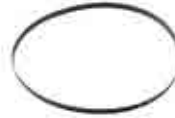
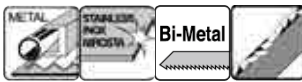

Length mm	Tooth Type	Material	Material of Blade	Tpi	Note	Range	Sales Pkg Qty	Part No.
835	Wave set	Plastics, Non-ferrous metal, Mild steel, Cast steel and cast iron, Hard steel and stainless steel	BiM	14	Material thickness:More than 5mm	★★★	5	B-40543
				18	Material thickness:4-5mm	★★★	5	B-40559
				24	Material thickness:Less than 4mm	★★★	5	B-40565

**Band saw blade for 1140mm Metal Raker type**

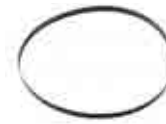
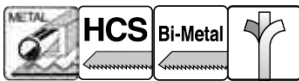

Length mm	Tooth Type	Material	Material of Blade	Tpi	Note	Range	Sales Pkg Qty	Part No.
1140	Raker set	Plastics, Non-ferrous metal, Mild steel	HCS	14	Material thickness:More than 5mm	★★★	3	792560-3
				18	Material thickness:4-5mm	★★★	3	792559-8
				24	Material thickness:Less than 4mm	★★★	3	792558-0
		Plastics, Non-ferrous metal, Mild steel, Cast steel and cast iron, Hard steel and stainless steel	BiM	10	Material thickness:More than 5.5mm	★★★	1	B-30128
				14	Material thickness:More than 5mm	★★★	1	792557-2
				18	Material thickness:4-5mm	★★★	1	792556-4

**Band saw blade for 1140mm Metal Wave type**

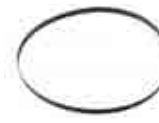
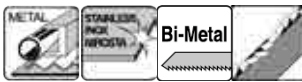

Length mm	Tooth Type	Material	Material of Blade	Tpi	Note	Range	Sales Pkg Qty	Part No.
1140	Wave set	Plastics, Non-ferrous metal, Mild steel, Cast steel and cast iron, Hard steel and stainless steel	BiM	14	Material thickness:More than 5mm	★★★	1	194691-8
				24	Material thickness:Less than 4mm	★★★	1	194692-6

**Band saw blade for 1140mm Wood Raker type**

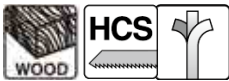

Length mm	Tooth Type	Material	Material of Blade	Tpi	Range	Sales Pkg Qty	Part No.
1140	Raker set	Wood	HCS	6	★★★	3	792567-9

**Band saw blade for 2240mm Metal Raker type**

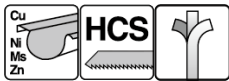

Length mm	Tooth Type	Material	Material of Blade	Tpi	Note	Range	Sales Pkg Qty	Part No.
2240	Raker set	Non-ferrous metal	HCS	14	Material thickness:More than 5mm	★★★	3	B-16695

**Band saw blade for 2240mm Wood Raker type**



Length mm	Tooth Type	Material	Material of Blade	Tpi	Range	Sales Pkg Qty	Part No.
2240	Raker set	Wood for cross cut	HCS	4	★★★	3	B-16667
		Wood for curve-cut	HCS	6	★★★	3	B-16689
		Wood for universal cut	HCS	4	★★★	3	B-16673

# ACCESSORIES

## ■ Brushing



Metal, mild steel



Wood



Plastic



Removing paint



Removing paint from metal or polishing

# Brushes for Grinder

## Shape type

Cup Type



Effective for flat or rugged surface

Wheel Type



Effective for working at spot

Bevel Type

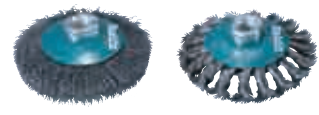

Effective for working at corner

## Trim materials

Steel

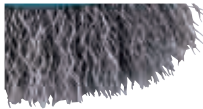

Ideal for metal material.

Steel (Brass coated)



Ideal for metal material.  
Feature of wire is resistant to rust.

Stainless



Ideal for stainless material. Feature of wire is resistant to rust, heat-resistant, and corrosion resistance.

## Wire type

Crimped

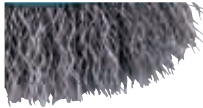

Ideal for light rust removal

Knotted



Ideal for heavy work

\*Cup Type



The side metal cover prevent steel wire from spreading. So this type of brush can keep high works effectively.

# Brushes for drill

## Shape type

Cup Type



Effective for flat or rugged surface

Wheel Type

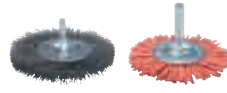

Effective for working at spot

End Type



Effective for tight or narrow place

Flap Type



Effective for treatment for wood

## Trim materials

Brush type	Steel Wire Knotted	Steel Wire Crimped	Brass coated Wire Crimped	Nylon Coase(#80) Wire Crimped	Nylon Coase(#240) Wire Crimped
Feature	Ideal for metal material and heavy work.	Ideal for metal material and light rust removal.	Ideal for metal material and wood material. Feature of wire is resistant to rust.	Ideal for light rust removal of metal material, wood and PVC.	Ideal for surface finishing of material, wood and PVC.
Work effectively	Very high efficiency	High efficiency	High efficiency	Low efficiency	very low efficiency
Finishing	Very Rough	Rough	Rough	Clean	More clean
Metal	◎	◎	◎	◎	◎
Wood	×	×	○	◎	◎
PVC	×	×	×	◎	◎

◎ : Highly suitable   ○ : Suitable   × : Not use

**Wire brush for angle grinder/ Cup/ Crimped**



Outer dia. mm (inch)	Thread mm (inch)	Brush Type	For Model	Range	Sales Pkg Qty	Part No.
60	M10x1.5	Steel wire 0.3mm	100mm Angle grinder	★★	1	D-24066
	M14x2.0		125, 150mm Angle grinder	★★	1	D-24072
75	M10x1.5		100mm Angle grinder	★★	1	D-24088
75	M14x2.0		125, 150mm Angle grinder	★★	1	D-24094
100			180, 230mm Angle grinder	★★	1	D-29284
60	M14x2.0		Brass coated steel wire 0.3mm	125, 150mm Angle grinder	★★	1
75		180, 230mm Angle grinder		★★	1	D-39768
90		180, 230mm Angle grinder		★★	1	D-39780
100		180, 230mm Angle grinder		★★	1	D-39805
(2-1/2)	(5/8x11 UNC)	Steel wire 0.0118 inch	115mm Angle grinder	★★	1	D-26515
(3)			180, 230mm Angle grinder	★★	1	D-26521
(4)		Brass coated steel wire 0.0118 inch	125, 150mm Angle grinder	★★	1	D-39752
(2-1/2)			180, 230mm Angle grinder	★★	1	D-39774
(3)			180, 230mm Angle grinder	★★	1	D-39796
(3-1/2)			180, 230mm Angle grinder	★★	1	D-39811

**Wire brush for angle grinder/ Wheel/ Knotted**



Outer dia. mm (inch)	Thread mm (inch)	Brush Type	For Model	Range	Sales Pkg Qty	Part No.
100	M14x2.0	Steel wire 0.5mm	125, 150, 180, 230mm Angle grinder	★★	1	D-29555
115				★★	1	D-29561
125				★★	1	D-29577
150			180, 230mm Angle grinder	★★	1	D-45761
175	(5/8x11 UNC)	Steel wire 0.02inch	230mm Angle grinder	★★	1	D-45777
(6)			180, 230mm Angle grinder	★★	1	D-45783
(7)			230mm Angle grinder	★★	1	D-45799

**Wire brush for angle grinder/ Bevel/ Crimped**



Outer dia. mm (inch)	Thread mm (inch)	Brush Type	For Model	Range	Sales Pkg Qty	Part No.
100	M14x2.0	Steel wire 0.3mm	125, 150, 180, 230mm Angle grinder	★★	1	D-39827
115				★★	1	D-39849
(4)	(5/8x11 UNC)	Steel wire 0.0118 inch	125, 150, 180, 230mm Angle grinder	★★	1	D-39833
(4-1/2)				★★	1	D-39855

**Wire brush for angle grinder/ Cup/ Knotted**



Outer dia. mm (inch)	Thread mm (inch)	Brush Type	For Model	Range	Sales Pkg Qty	Part No.
60	M10x1.5	Steel wire 0.5mm	100mm Angle grinder	★★	1	D-24103
75			125, 150mm Angle grinder	★★	1	D-24125
60	M14x2.0		125, 150mm Angle grinder	★★	1	D-24119
75			115mm Angle grinder	★★	1	D-24131
(2-1/2)	(5/8x11 UNC)	Steel wire 0.02inch	115mm Angle grinder	★★	1	D-26537
(3)			180, 230mm Angle grinder	★★	1	D-26543
(4)			180, 230mm Angle grinder	★★	1	D-31706

**Wire brush for angle grinder/ Bevel/ Knotted**

Effective for working at corner



Outer dia. mm (inch)	Thread mm (inch)	Brush Type	For Model	Range	Sales Pkg Qty	Part No.
100	M14x2.0	Steel wire 0.5mm	125, 150, 180, 230mm Angle grinder	★★	1	D-39861
115				★★	1	D-39883
(4)	(5/8x11 UNC)	Steel wire 0.02inch	125, 150, 180, 230mm Angle grinder	★★	1	D-39877
(4-1/2)				★★	1	D-39899

**Wire brush for angle grinder/ Cup with metal cover/ Knotted**

Effective for flat or rugged surface



Outer dia. mm (inch)	Thread mm (inch)	Brush Type	For Model	Range	Sales Pkg Qty	Part No.
60	M10x1.5	Steel wire 0.5mm	100mm Angle grinder	★★	1	D-24147
60	M14x2.0		125, 150mm Angle grinder	★★	1	D-24153
			180, 230mm Angle grinder	★★	1	D-29290
(2-1/2)	(5/8x11 UNC)	Steel wire 0.02inch	115mm Angle grinder	★★	1	D-26559
(4)			180, 230mm Angle grinder	★★	1	D-31712

### Wire brush for angle grinder with X-lock/ Cup/ Crimped

X-LOCK system for toolless brush installation



Outer dia. mm	Thread	Brush Type	For Model	Range	Sales Pkg Qty	Part No.
75	X-lock	Brass coated steel wire 0.3mm	100, 115, 125mm Angle grinder (X-LOCK)	★★★	1	D-73433
		Stainless steel wire 0.3	100, 115, 125mm Angle grinder (X-LOCK)	★★★	1	D-73346
		Steel wire 0.3mm	100, 115, 125mm Angle grinder (X-LOCK)	★★★	1	D-73396

### Wire brush for angle grinder with X-lock/ Cup/ Knotted

X-LOCK system for toolless brush installation



Outer dia. mm	Thread	Brush Type	For Model	Range	Sales Pkg Qty	Part No.
80	X-lock	Stainless steel wire 0.5mm	100, 115, 125mm Angle grinder (X-LOCK)	★★★	1	D-73330
		Steel wire 0.35mm	100, 115, 125mm Angle grinder (X-LOCK)	★★★	1	D-73374
		Steel wire 0.5mm	100, 115, 125mm Angle grinder (X-LOCK)	★★★	1	D-73380

### Wire brush for angle grinder with X-lock/ Wheel/ Crimped

X-LOCK system for toolless brush installation



Outer dia. mm	Thread	Brush Type	For Model	Range	Sales Pkg Qty	Part No.
115	X-lock	Steel wire 0.3mm	115, 125mm Angle grinder (X-LOCK)	★★★	1	D-73427

### Wire brush for angle grinder with X-lock/ Wheel/ Knotted

X-LOCK system for toolless brush installation



Outer dia. mm	Thread	Brush Type	For Model	Range	Sales Pkg Qty	Part No.
115	X-lock	Stainless steel wire 0.5mm (Full Knotted)	115, 125mm Angle grinder (X-LOCK)	★★★	1	D-73352
		Stainless steel wire 0.5mm (Stringer Knotted)	115, 125mm Angle grinder (X-LOCK)	★★★	1	D-73368
		Steel wire 0.5mm (Full Knotted)	115, 125mm Angle grinder (X-LOCK)	★★★	1	D-73405
		Steel wire 0.5mm (Stringer Knotted)	115, 125mm Angle grinder (X-LOCK)	★★★	1	D-73411

### Wire brush for angle grinder with X-lock/ Bevel/ Crimped

X-LOCK system for toolless brush installation



Outer dia. mm	Thread	Brush Type	For Model	Range	Sales Pkg Qty	Part No.
100	X-lock	Steel wire 0.3mm	100, 115, 125mm Angle grinder (X-LOCK)	★★★	1	D-73449



### Wire brush for drill/ Cup/ Crimped

Effective for flat or rugged surface



Outer dia. mm	Shaft mm (inch)	Brush Type	Range	Sales Pkg Qty	Part No.
38	6	Steel wire 0.3mm	★★	1	D-39908
50			★★	1	D-39914
63			★★	1	D-39920
75			★★	1	D-39936
80			★★	1	D-39942
38	(1/4 Hex MZ)	Brass coated steel wire 0.3mm	★★	1	D-73601
50			★★	1	D-73617
63			★★	1	D-73623
75			★★	1	D-73639
80			★★	1	D-73645

### Wire brush for drill/ Cup/ Knotted



Outer dia. mm	Shaft mm	Brush Type	Range	Sales Pkg Qty	Part No.
63	6	Steel wire 0.5mm	★★	1	D-73798
75	6		★★	1	D-73807

### Wire brush for drill/ Wheel/ Crimped

Effective for working at spot



Outer dia. mm	Shaft mm (inch)	Brush Type	Range	Sales Pkg Qty	Part No.
38	6	Steel wire 0.3mm	★★	1	D-39958
50			★★	1	D-39964
63			★★	1	D-39970
75			★★	1	D-39986
100			★★	1	D-39992
80	8	Brass coated steel wire 0.25mm	★★	1	D-67608
38	(1/4 Hex MZ)	Brass coated steel wire 0.3mm	★★	1	D-73651
50			★★	1	D-73667
63			★★	1	D-73673
75			★★	1	D-73689
100			★★	1	D-73695

### Wire brush for drill/ Wheel/ Knotted



Outer dia. mm	Shaft mm	Brush Type	Range	Sales Pkg Qty	Part No.
75	6	Steel wire 0.5mm	★★	1	D-73813
100	6		★★	1	D-73829

### Wire brush for drill/ End/ Crimped

Effective for tight or narrow place



Outer dia. mm	Shaft mm (inch)	Brush Type	Range	Sales Pkg Qty	Part No.
12	6	Steel wire 0.3mm	★★	1	D-40004
19			★★	1	D-40010
25			★★	1	D-40026
30			★★	1	D-40032
12	(1/4 Hex MZ)	Brass coated steel wire 0.3mm	★★	1	D-73704
19			★★	1	D-73710
24			★★	1	D-73726
28			★★	1	D-73732

### Wire brush for drill/ End/ Knotted



Outer dia. mm	Shaft mm	Brush Type	Range	Sales Pkg Qty	Part No.
12	6	Steel wire 0.5mm	★★	1	D-73835
19			★★	1	D-73841
24			★★	1	D-73857
28			★★	1	D-73863

### Wire brush for drill assortment set



Note	Shaft mm	Brush Type	Range	Sales Pkg Qty	Part No.
Cup-Crimped:50mm, End-Crimped:25mm, Wheel-Crimped:50mm	6	Steel wire 0.3mm	★★	3	D-66070
Cup-Crimped:63,75mm, Wheel-Crimped:75,100mm			★★	4	D-65729

### Nylon brush for drill/ Cup

Effective for flat or rugged surface

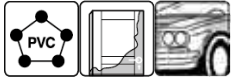

Outer dia. mm	Shaft mm	Brush Type	Range	Sales Pkg Qty	Part No.
50	6	Coarse	★★	1	D-45509
63			★★	1	D-45515
75			★★	1	D-45521
50	6	Fine	★★	1	D-45537
63			★★	1	D-45543
75			★★	1	D-45559

### Nylon brush for drill/ Wheel

Effective for working at spot

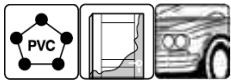

Outer dia. mm	Shaft mm	Brush Type	Range	Sales Pkg Qty	Part No.
38	6	Coarse	★★	1	D-45565
50			★★	1	D-45571
63			★★	1	D-45587
75			★★	1	D-45593
100			★★	1	D-45602
38	6	Fine	★★	1	D-45618
50			★★	1	D-45624
63			★★	1	D-45630
75			★★	1	D-45646
100			★★	1	D-45652

### Nylon brush for drill/ End

Effective for tight or narrow place

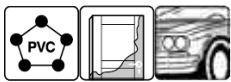

Outer dia. mm	Shaft mm	Brush Type	Range	Sales Pkg Qty	Part No.
12	6	Coarse	★★	1	D-45668
17			★★	1	D-45674
24			★★	1	D-45680
30			★★	1	D-45696
12	6	Fine	★★	1	D-45705
17			★★	1	D-45711
24			★★	1	D-45727
30			★★	1	D-45733

### Nylon brush for drill/ Flap

Effective for wood treatment

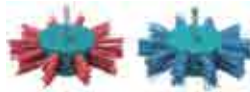
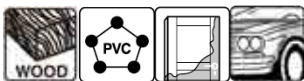

Outer dia. mm	Shaft mm	Brush Type	Range	Sales Pkg Qty	Part No.
100	6	Coarse	★★	1	D-45749
100	6	Fine	★★	1	D-45755

### Nylon brush for drill assortment set

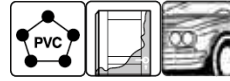

Note	Shaft mm	Brush Type	Range	Sales Pkg Qty	Part No.
Cup:50mm, Wheel:50mm, End:24mm	6	Coarse	★★	3	D-70742
Cup:50mm, Wheel:50mm, End:24mm	6	Fine	★★	3	D-70758

### Wire brush for wheel sander



Outer dia. mm	Brush Type	Range	Sales Pkg Qty	Part No.
100	Brass coated steel wire 0.3mm	★★	1	D-73570
100	Steel wire 0.3mm	★★	1	D-73564

### Nylon brush for wheel sander



Outer dia. mm	Brush Type	Grit	Range	Sales Pkg Qty	Part No.
100	Coarse	60	★★	1	D-73586
100	Medium	80	★★	1	D-73592

### 100mm Diamond polishing pad

(Hook & loop type)  
8 pads assortment (1 each) D-15805



Model No.	Color	Grit	Range	Sales Pkg Qty	Part No.
PW5000C, PW5001C	Blue	50	★★★	1	D-15584
	Yellow	100	★★★	1	D-15590
	Orange	200	★★★	1	D-15609
	Red	400	★★★	1	D-15615
	Dark green	800	★★★	1	D-15621
	Light green	1500	★★★	1	D-15637
	Brown	3000	★★★	1	D-15643
	Green	Buff (Finishing)	★★★	1	D-15659

### Sponge type

#### Flat

Feature: Full contact surface  
Use: Suitable for large, flat, panel



#### Wave

Feature: Air flow between the pad and the paint.  
Use: Suitable for bumper made with resin.



### Sponge pad/ High repulsion



### Color & Application

#### Coarse

Color: Orange  
"Use: Suitable for making wool bonnet sanding trace invisible



#### Medium

Color: Blue  
Use: Suitable for finishing



#### Fine

Color: Black  
"Use: Suitable for Mirror finishing applying wax, making polishing traces invisible



Outer dia. mm	Note	Type	Brush Type	Range	Sales Pkg Qty	Part No.
100		Flat	Coarse	★★	1	D-62505
			Medium	★★	1	D-62533
			Fine	★★	1	D-62561
		Wave	Coarse	★★	1	D-62599
			Medium	★★	1	D-62620
			Fine	★★	1	D-62658
125	Hook & Loop type	Flat	Coarse	★★	1	D-62511
			Medium	★★	1	D-62549
			Fine	★★	1	D-62577
		Wave	Coarse	★★	1	D-62608
			Medium	★★	1	D-62636
			Fine	★★	1	D-62664
150		Flat	Coarse	★★	1	D-62527
			Medium	★★	1	D-62555
			Fine	★★	1	D-62583
		Wave	Coarse	★★	1	D-62614
			Medium	★★	1	D-62642
			Fine	★★	1	D-62670
190		Flat	Coarse	★★	1	D-74572
			Medium	★★	1	D-74588
			Fine	★★	1	D-70801

### Wool pad/ Double side adapter

For Angle sander/Sander-polisher/ Polisher; necessary to use the grinder with less than 4,000 RPM



Note	Range	Sales Pkg Qty	Part No.
M14 Adapter for Wool pad Double side	★★	1	D-56960
M16 Adapter for Wool pad Double side	★★	1	D-57043

### Sponge pad/ Low repulsion

### Color & Application

#### Coarse

Color: Yellow  
"Use: Suitable for making paper sanding traces invisible



#### Medium

Color: White  
Use: Suitable for finishing



Outer dia. mm	Note	Type	Brush Type	Range	Sales Pkg Qty	Part No.
120	Hook & Loop type	Flat	Coarse	★★	1	D-74647
150				★★	1	D-74653
170				★★	1	D-74669
190				★★	1	D-70786
190				★★	1	D-70792

### Wool pad



Outer dia. mm	Type	Range	Sales Pkg Qty	Part No.
100	Hook & Loop	★★	1	D-67000
125	Hook & Loop	★★	1	D-70867
150	Hook & Loop	★★	1	D-65735
180	Hook & Loop	★★	1	D-74594

### Wool pad/ Double side

It is ideal for bright finishing.



Outer dia. mm	Note	Brush Type	Range	Sales Pkg Qty	Part No.
230	Use with M14/M16 adapter	Coarse	★★	1	D-70873
230	Use with M14/M16 adapter	Fine	★★	1	D-70889

### Felt pad



Outer dia. mm	Note	Range	Sales Pkg Qty	Part No.
100	Hook&Loop type	★★	1	D-74603
125	Hook&Loop type	★★	1	D-74631
150	Hook&Loop type	★★	1	D-74619
190	Hook&Loop type	★★	1	D-74625

# ACCESSORIES

## ▣ Bonded Abrasive



Metal, mild steel



Metal stud



Stainless steel



Aluminum



Plaster\_mortar



Tile



Plastic



3mm cylindrical shank



6mm cylindrical shank



Flexible



Always use back up pad



die grinder

## New Label design



Lot number : printed in label  
 Validity : on washer (If there is not on washer, there is on label.)

### Point 1 The icon tell that how to use.

	for metal	for INOX	for Masonry	for Aluminum
Grinding				
Cutting for grinder				
Cutting for portable cut-off		—	—	—
Cutting for power cutter		—	—	—

**Point 2** The marks tell the range in makita.



**Point 3** How to read the spec.

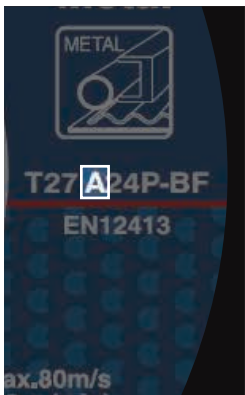

**Aluminum Oxide Group ( mainly for metal & INOX )**

**Brown Fused Aluminum: A**  
The most common abrasive material for metal.



**Single Aluminum Oxide: SA**  
Single crystal abrasive material with high tenacity. Higher durability and grinding/cutting performance than A.



**White Aluminum Oxide: WA**  
High purity abrasive material, eliminated extraneous elements from A. Higher grinding and cutting performance than A.



**Alumina Zirconium: Z**  
Extremely sharp and hard abrasive material. Grinding/cutting performance than SA.

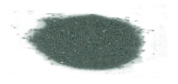

**Ceramic:**   
Extremely sharp and high resistant to shock/heat/wear. High grade abrasive material with excellent grinding performance and durability.

**Silicon Oxide Group (mainly for non-metallic)**

**Black Silicon Carbide: C**  
The most common abrasive material for non-metal.



**Green Silicon Carbide: GC**  
Higher purity than C, eliminated extraneous elements, thus having higher grinding and cutting performance than C, but a little lower durability than C.

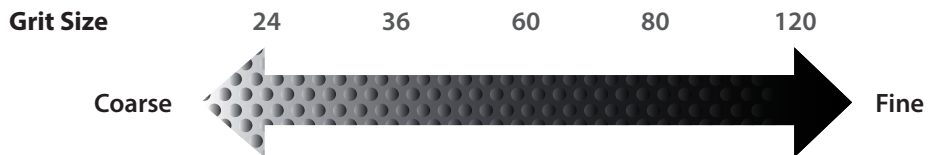

**Hardness of grinding wheel**

Closer to A, softer grinding wheel is  
Closer to Z, harder grinding wheel is

Soft grinding wheel ▶ Hard work piece  
Hard grinding wheel ▶ Soft work piece



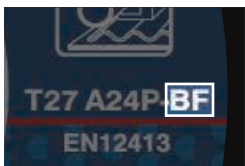

Very Soft	Soft	Middle	Hard	Very Hard
A - G	H - K	L - O	P - S	T - Z



**Type of Bond**

BF : Reinforced resinoid bond  
V : Vitrified bond

**Point 4** The color tell the application.

	for metal	for INOX	for Masonry	for Aluminum
color	 Blue	 Orange	 Green	 Gray

**Grinding wheel/ Metal/ Depressed**



Outer dia. mm	Thickness mm	Inner dia. mm	Grit	Range	Sales Pkg Qty	Part No.
100	4.0	16.00	A36P	★★★	1	A-80905
	4.0	16.00	A24P	★	1	D-72883
	6.0	16.00	A24P	★★★	1	A-85391
	6.0	16.00	A24R	★★★	1	A-87719
	6.0	16.00	A36P	★★★	1	A-80911
	6.0	16.00	A24P	★★	1	D-65090
	6.0	16.00	A24P	★	1	D-72241
115	6.0	22.23	A36P	★★★	1	A-80927
	6.0	22.23	A24R	★★	1	D-18459
	6.0	22.23	A24P	★	20	D-18459-20
125	6.0	22.23	A36P	★★★	1	D-74485
	6.0	22.23	A24R	★★	1	A-80933
	6.0	22.23	A24P	★	1	D-18465
150	6.0	22.23	A24P	★★	20	D-18465-20
	6.0	22.23	A24P	★	1	D-65919
	6.0	22.23	A24P	★	1	D-74491
180	6.0	22.23	A36P	★★★	1	A-84981
	6.0	22.23	A24R	★★	1	D-26163
	6.0	22.23	A24P	★★	1	D-65925
230	6.0	22.23	A24P	★	1	D-74500
	6.0	22.23	A36P	★★★	1	A-80949
	6.0	22.23	A24R	★★★	1	A-88886
230	6.0	22.23	A24R	★★	1	D-18471
	6.0	22.23	A24P	★	1	D-74516
	6.0	22.23	A36P	★★★	1	A-80955
230	6.0	22.23	A24R	★★	1	D-18487
	6.0	22.23	A24P	★	1	D-74522

**Grinding wheel/ Metal/ Depressed with X-LOCK**



Outer dia. mm	Thickness mm	Thread mm	Grit	Range	Sales Pkg Qty	Part No.
100	6.0	X-LOCK	A36P	★★★	1	E-00480
115	6.0	X-LOCK	A36P	★★★	1	E-00365
125	6.0	X-LOCK	A36P	★★★	1	E-00393

**Grinding wheel/ Stainless/ Depressed**



Outer dia. mm	Thickness mm	Inner dia. mm	Grit	Range	Sales Pkg Qty	Part No.
100	6.0	16.00	A24R	★★★	1	B-21107
	6.0	16.00	WA36N	★★★	1	A-80852
115	6.0	22.23	A24R	★★★	1	B-21113
	6.0	22.23	WA36N	★★★	1	A-80640
125	6.0	22.23	A24R	★★★	1	B-21129
	6.0	22.23	WA36N	★★★	1	A-80656
150	6.0	22.23	WA36N	★★★	1	A-80846
180	6.0	22.23	A24R	★★★	1	B-21135
	6.0	22.23	WA36O	★★★	1	A-80880
230	6.0	22.23	A24R	★★★	1	B-21141
	6.0	22.23	WA36O	★★★	1	A-80896

**Grinding wheel/ Stainless/ Depressed/ For heavy Industries**



1. 7.2mm thickness for Heavy Industries.  
It is suitable to use with a high power grinder.

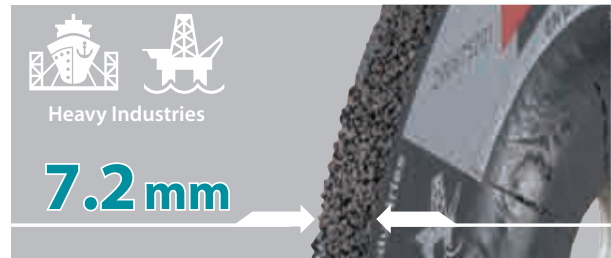

2. Longer Life

Grinding life time (min)

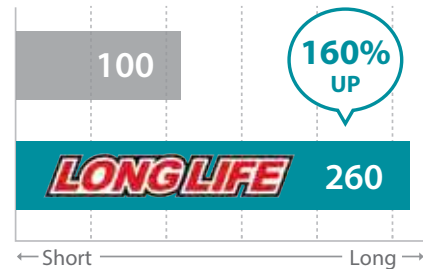
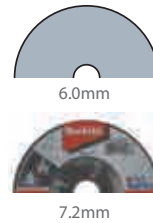

Outer dia. mm	Thickness mm	Inner dia. mm	Grit	Range	Sales Pkg Qty	Part No.
115	7.0	22.23	A24P (CERAMIC)	★★★★★	1	B-66911
	7.2	22.23	A24S	★★★★	1	B-56362
	7.2	22.23	AZ24N	★★★★	1	B-56378
125	7.0	22.23	A24P (CERAMIC)	★★★★★	1	B-66927
	7.2	22.23	A24S	★★★★	1	B-56384
	7.2	22.23	AZ24N	★★★★	1	B-56390
180	7.2	22.23	A24S	★★★★	1	B-56409
	7.2	22.23	AZ24N	★★★★	1	B-56415

**Grinding wheel/ Stainless/ Depressed with X-LOCK**



Outer dia. mm	Thickness mm	Thread mm	Grit	Range	Sales Pkg Qty	Part No.
100	6.0	X-LOCK	WA36N	★★★	1	E-00496
115	6.0	X-LOCK	WA36N	★★★	1	E-00371
125	6.0	X-LOCK	WA36N	★★★	1	E-00402

### Grinding wheel/ Aluminium/ Depressed



Outer dia. mm	Thickness mm	Inner dia. mm	Grit	Range	Sales Pkg Qty	Part No.
100	6.0	16.00	A36N	★★★★	1	B-17706
115	6.0	22.23	A36N	★★★★	1	B-14560
125	6.0	22.23	A36N	★★★★	1	B-17653
150	6.0	22.23	A36N	★★★★	1	B-17669
180	6.0	22.23	A36N	★★★★	1	B-14576
230	6.0	22.23	A36N	★★★★	1	B-14582

Outer dia. mm	Thickness mm	Inner dia. mm	Grit	Range	Sales Pkg Qty	Part No.
180	3.0	22.23	AC36	★★★★	1	B-18356
	3.0	22.23	AC46	★★★★	1	B-18362
	3.0	22.23	AC60	★★★★	1	A-88490
	3.0	22.23	AC80	★★★★	1	B-18378
230	3.0	22.23	AC36	★★★★	1	B-18384
	3.0	22.23	AC46	★★★★	1	B-18390
	3.0	22.23	AC60	★★★★	1	B-18409
	3.0	22.23	AC80	★★★★	1	B-18415

### Grinding wheel/ Masonry/ Depressed



Outer dia. mm	Thickness mm	Inner dia. mm	Grit	Range	Sales Pkg Qty	Part No.
100	6.0	16.00	C24R	★★	1	D-18493
115	6.0	22.23	C24R	★★	1	D-18502
125	6.0	22.23	C24R	★★	1	D-18518
150	6.0	22.23	C24R	★★	1	D-18524
180	6.0	22.23	C24R	★★	1	D-18530
230	6.0	22.23	C24R	★★	1	D-18546

### Flexible grinding wheel/ Stainless/ Depressed



Outer dia. mm	Thickness mm	Inner dia. mm	Grit	Range	Sales Pkg Qty	Part No.
100	2.0	16.00	WA46	★★★★	1	B-18421
	2.0	16.00	WA60	★★★★	1	B-18437
	2.0	16.00	WA80	★★★★	1	B-18443
	2.0	16.00	WA120	★★★★	1	B-18459
	3.0	16.00	WA36	★★★★	1	B-18465
	3.0	16.00	WA46	★★★★	1	B-18471
	3.0	16.00	WA60	★★★★	1	B-18487
	3.0	16.00	WA80	★★★★	1	B-18493
	3.0	16.00	WA80	★★★★	1	B-18493
115	3.0	22.23	WA36	★★★★	1	B-18502
	3.0	22.23	WA46	★★★★	1	B-18518
	3.0	22.23	WA60	★★★★	1	B-18524
	3.0	22.23	WA80	★★★★	1	B-18530
125	3.0	22.23	WA36	★★★★	1	B-18546
	3.0	22.23	WA46	★★★★	1	B-18552
	3.0	22.23	WA60	★★★★	1	B-18568
180	3.0	22.23	WA80	★★★★	1	B-18574
	3.0	22.23	WA80	★★★★	1	B-18574
	3.0	22.23	WA36	★★★★	1	B-18580
	3.0	22.23	WA46	★★★★	1	B-18596
	3.0	22.23	WA60	★★★★	1	B-18605
	3.0	22.23	WA80	★★★★	1	B-18611
230	3.0	22.23	WA36	★★★★	1	B-18627
	3.0	22.23	WA46	★★★★	1	B-18633
	3.0	22.23	WA60	★★★★	1	B-18649
	3.0	22.23	WA80	★★★★	1	B-18655

### Flexible grinding wheel

1. Less noise
2. Low vibration
3. As flexible grinding wheel cause almost no tapping, it provides excellent workability
4. Wide range of Applications



### Flexible grinding wheel/ Stainless/ Depressed/ Ideal for Cordless angle grinder



1. Amount of grinding per 1 charged 70% up than grinding wheel/ stainless.
2. Vibration 60% off than grinding wheel/ stainless.



### Flexible grinding wheel/ Metal/ Depressed



Outer dia. mm	Thickness mm	Inner dia. mm	Grit	Range	Sales Pkg Qty	Part No.
100	2.0	16.00	AC46	★★★★	1	B-18203
	2.0	16.00	AC60	★★★★	1	A-85139
	2.0	16.00	AC80	★★★★	1	B-18219
	2.0	16.00	AC120	★★★★	1	B-18225
	3.0	16.00	AC36	★★★★	1	B-18231
	3.0	16.00	AC46	★★★★	1	B-18247
	3.0	16.00	AC60	★★★★	1	B-18253
	3.0	16.00	AC80	★★★★	1	B-18269
	3.0	16.00	AC80	★★★★	1	B-18269
115	3.0	22.23	AC36	★★★★	1	B-18275
	3.0	22.23	AC46	★★★★	1	B-18281
	3.0	22.23	AC60	★★★★	1	B-18297
125	3.0	22.23	AC80	★★★★	1	B-18306
	3.0	22.23	AC36	★★★★	1	B-18312
	3.0	22.23	AC46	★★★★	1	B-18328
	3.0	22.23	AC60	★★★★	1	B-18334
	3.0	22.23	AC80	★★★★	1	B-18340

Outer dia. mm	Thickness mm	Inner dia. mm	Grit	Range	Sales Pkg Qty	Part No.
100	4.0	16.00	WA36P	★★★★★	1	B-52392
115	4.0	22.23	WA36P	★★★★★	1	B-49775
125	4.0	22.23	WA36P	★★★★★	1	B-53110

### Flexible grinding wheel/ Masonry/ Depressed



1. GC grain



Contains GC (Green Silicon Carbide) grain which is specialized to grind stone/glass.

2. Ground surface



A rough ground surface releases dust smoothly and reduces clogging.

3. Flexible



Original manufacturing method realized high flexibility. Clean surface is available.

#### Application

1. Chamfering of marble



2. Grinding marble's curved surface



3. Deburring of glass



\*Always use with back-up pad.

Outer dia. mm	Thickness mm	Inner dia. mm	Grit	Range	Sales Pkg Qty	Part No.
100	2.0	16.00	GC46	★★★	1	B-18661
	2.0	16.00	GC60	★★★	1	B-18677
	2.0	16.00	GC80	★★★	1	B-18683
	2.0	16.00	GC120	★★★	1	B-18699
	3.0	16.00	GC36	★★★	1	B-18708
	3.0	16.00	GC60P	★★★	1	B-51356
	3.0	16.00	GC80P	★★★	1	B-51362
	3.0	16.00	GC120P	★★★	1	B-51378

### Back up pad for Flexible grinding wheel



Note	Range	Sales Pkg Qty	Part No.
Back Up Pad for 100mm	★★★	1	B-20476
Back Up Pad for 115/125mm	★★★	1	B-20482
Back Up Pad for 180mm	★★★	1	B-20498
Back Up Pad for 230mm	★★★	1	B-20507

### Cut-off wheel/ Metal/ Flat



Outer dia. mm	Thickness mm	Inner dia. mm	Grit	Range	Sales Pkg Qty	Part No.
100	2.0	16.00	A46S	★★★	1	A-85123
	2.5	16.00	A30R	★★★	1	A-85298
	2.5	16.00	A30S	★★	1	D-18655
115	2.5	22.23	A30R	★★★	1	A-85307
	2.5	22.23	A30S	★★	1	D-18661
125	2.5	22.23	A30R	★★★	1	A-85313
	2.5	22.23	A30S	★★	1	D-18677
150	2.5	22.23	A30S	★★	1	D-29402
180	2.5	22.23	A30R	★★★	1	A-85329
	2.5	22.23	A30S	★★	1	D-18683
230	2.5	22.23	A30R	★★★	1	A-85335
	2.5	22.23	A30S	★★	1	D-18699

### Cut-off wheel/ Metal/ Depressed



Outer dia. mm	Thickness mm	Inner dia. mm	Grit	Range	Sales Pkg Qty	Part No.
100	3.0	16.00	A30T	★★★	1	A-83587
	3.0	16.00	A30S	★★	1	D-18552
115	3.0	22.23	A30T	★★★	1	A-83593
	3.0	22.23	A36T	★★★	1	B-21200
125	3.0	22.23	A30S	★★	1	D-18568
	3.0	22.23	A30T	★★★	1	A-83602
150	3.0	22.23	A30S	★★	1	D-18574
	3.0	22.23	A30T	★★★	1	B-05050
180	3.0	22.23	A30T	★★★	1	A-83618
	3.0	22.23	A30S	★★	1	D-18580
230	3.0	22.23	A30T	★★★	1	A-83624
	3.0	22.23	A30R	★★★	1	B-62913
	3.0	22.23	A30S	★★	1	D-18596

### Cut-off wheel/ Masonry/ Flat



Outer dia. mm	Thickness mm	Inner dia. mm	Grit	Range	Sales Pkg Qty	Part No.
100	3.0	16.00	C30T	★★★	1	A-86739
	3.0	16.00	C30S	★★	1	D-18708
115	3.0	22.23	C30T	★★★	1	A-85357
	3.0	22.23	C30S	★★	1	D-18714
125	3.0	22.23	C30T	★★★	1	A-85363
	3.0	22.23	C30S	★★	1	D-18720
180	3.0	22.23	C30T	★★★	1	A-85379
	3.0	22.23	C30S	★★	1	D-18736
230	3.0	22.23	C30T	★★★	1	A-85385
	3.0	22.23	C30S	★★	1	D-18742

**Cut-off wheel/ Masonry/ Depressed**



Outer dia. mm	Thickness mm	Inner dia. mm	Grit	Range	Sales Pkg Qty	Part No.
100	3.0	16.00	C30T	★★★	1	A-86745
	3.0	16.00	C30S	★★	1	D-18605
115	3.0	22.23	C30T	★★★	1	A-85254
	3.0	22.23	C30S	★★	1	D-18611
125	3.0	22.23	C30T	★★★	1	A-85260
	3.0	22.23	C30S	★★	1	D-18627
180	3.0	22.23	C30T	★★★	1	A-85276
	3.0	22.23	C30S	★★	1	D-18633
230	3.0	22.23	C30T	★★★	1	A-85282
	3.0	22.23	C30S	★★	1	D-18649

**Thin cut-off wheel/ Metal/ Flat**



Outer dia. mm	Thickness mm	Inner dia. mm	Grit	Range	Sales Pkg Qty	Part No.
115	1.6	22.23	A46U	★★★	1	B-14102
					10	B-14102-10
125	1.6	22.23	A46U	★★★	1	B-35134
					10	B-35134-10

**Thin cut-off wheel/ Stainless metal/ Flat**



Outer dia. mm	Thickness mm	Inner dia. mm	Grit	Range	Sales Pkg Qty	Part No.
100	1.6	16.00	A36S	★★★	1	B-45749
115	1.6	22.23	A36S	★★★	1	B-45755
125	1.6	22.23	A36S	★★★	1	B-46931
180	1.8	22.23	A36S	★★★	1	B-60458
230	2.0	22.23	A36S	★★★	1	B-60464

**Thin cut-off wheel/ Stainless/ Flat**



Outer dia. mm	Thickness mm	Inner dia. mm	Grit	Range	Sales Pkg Qty	Part No.	
100	1.0	16.00	A60T	★★★	1	B-12201	
			12	B-12201-12			
	1.0	16.00	A60U	★★★	1	E-03028	
					12	E-03028-12	
					25	E-03028-25	
	1	1	D-65947				
1.0	16.00	WA46R	★★	10	D-65947-10		
				12	D-65947-12		
				1	D-18758		
115	1.0	22.23	A60T	★★★	1	B-12217	
			12	B-12217-12			
	1.0	22.23	A60U	★★★	1	E-03034	
					12	E-03034-12	
					25	E-03034-25	
	1	1	D-65953				
	1.0	22.23	WA46R	★★	10	D-65953-10	
					12	D-65953-12	
	1.2	22.23	WA60T	★★	1	D-18764	
					10	D-18764-10	
	125	1.0	22.23	A60T	★★★	1	B-12239
				12	B-12239-12		
1.0		22.23	A60U	★★★	1	E-03040	
					12	E-03040-12	
					25	E-03040-25	
1		1	D-65969				
1.0		22.23	WA46R	★★	10	D-65969-10	
					12	D-65969-12	
1.2		22.23	WA60T	★★	1	D-18770	
					10	D-18770-10	
150	1.6	22.23	A60T	★★★	1	B-12251	
	2.0	22.23	WA36R	★★	1	D-29424	
	1.6	22.23	A60T	★★★	1	B-12267	
180	2.0	22.23	WA36R	★★	1	D-18786	
	2.0	22.23	WA46R	★★	1	D-65975	
	1.9	22.23	A60T	★★★	1	B-12273	
230	2.0	22.23	WA36R	★★	1	D-18792	

**Thin cut-off wheel/ Stainless/ Flat with X-LOCK**



Outer dia. mm	Thickness mm	Thread mm	Grit	Range	Sales Pkg Qty	Part No.
100	1.2	X-LOCK	A60T	★★★	1	E-00505
115	1.2	X-LOCK	A60T	★★★	1	E-00387
125	1.2	X-LOCK	A60T	★★★	1	E-00418

**Thin cut-off wheel/ Stainless/ Flat/ Ideal for Cordless power cutter**



Outer dia. mm	Thickness mm	Inner dia. mm	Grit	Range	Sales Pkg Qty	Part No.
230	2.0	22.23	WA36R	★★★	1 25	E-03006 E-03006-25

**Thin cut-off wheel/ Stainless/ Depressed**



Outer dia. mm	Thickness mm	Inner dia. mm	Grit	Range	Sales Pkg Qty	Part No.
100	1.2	16.00	WA60T	★★	1	D-18801
115	1.2	22.23	A60T	★★★	1	B-64587
125	1.2	22.23	WA60T	★★	1	D-18817
	1.6	22.23	A60T	★★★	1	B-64593
180	1.6	22.23	WA46T	★★	1	D-18823
	2.0	22.23	A60T	★★★	1	B-64602
230	1.9	22.23	WA36R	★★	1	D-18839
	2.0	22.23	A60T	★★★	1	B-64618
			WA36R	★★	1	D-18845

**Thin cut-off wheel/ Aluminium/ Flat**



Outer dia. mm	Thickness mm	Inner dia. mm	Grit	Range	Sales Pkg Qty	Part No.
100	1.0	16.00	A60T	★★★	1	B-45319
115	1.0	22.23	A60T	★★★	1	B-45325
125	1.0	22.23	A60T	★★★	1	B-45331
150	1.6	22.23	A60T	★★★	1	B-45347
180	1.6	22.23	A60T	★★★	1	B-45353
230	1.9	22.23	A60T	★★★	1	B-45369

**Thin cut-off wheel/ Multi material/ Flat**



Outer dia. mm	Thickness mm	Inner dia. mm	Grit	Range	Sales Pkg Qty	Part No.
100	1.2	16.00	C46T	Specialized	1	E-10702
115	1.2	22.23	C46T	Specialized	1	E-10718
125	1.2	22.23	C46T	Specialized	1	E-10724

**Ultra thin cut-off wheel/ Stainless**

1. Cutting speed 40% up than 1.0mm cutting.
2. Number of cut with 1 charge 20% up than 1.0mm cutting.
3. Less burr of materials



4. Less dust of materials



**Ultra thin cut-off wheel/ Stainless/ Flat/ Ideal for Cordless angle grinder**



Outer dia. mm	Thickness mm	Inner dia. mm	Grit	Range	Sales Pkg Qty	Part No.
100	0.8	16.00	Z60T	★★★★	1	B-45711
			Z60U	★★★★	12	B-45711-12
	0.8	16.00	Z60U	★★★★	25	E-10855-25
115	0.8	22.23	Z60T	★★★★	1	B-45727
			Z60U	★★★★	12	B-45727-12
	0.8	22.23	Z60U	★★★★	25	E-10861-25
125	0.8	22.23	Z60T	★★★★	1	B-45733
			Z60U	★★★★	12	B-45733-12
	0.8	22.23	Z60U	★★★★	25	E-10877-25

**Ultra thin cut-off wheel/ Stainless/ Depressed/ Ideal for Cordless angle grinder**



Outer dia. mm	Thickness mm	Inner dia. mm	Grit	Range	Sales Pkg Qty	Part No.
115	0.8	22.23	Z60T	★★★★	1	B-46947
125	0.8	22.23	Z60T	★★★★	1	B-46953

**Grinding wheel/ Metal/ Depressed/ 2in1**



1. Grinding and cutting with one wheel.
2. Time and cost saving thanks to its efficient workability.
3. Recommendable from DIY to professional.

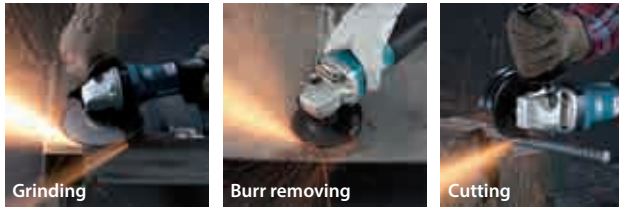

Outer dia. mm	Thickness mm	Inner dia. mm	Grit	Range	Sales Pkg Qty	Part No.
100	3.2	16.00	A36T	★★★★	1	B-21222
115	3.2	22.23	A36T	★★★★	1	B-21238
125	3.2	22.23	A36T	★★★★	1	B-21244
180	4.0	22.23	A36T	★★★★	1	B-21250

**Grinding wheel/ Stainless/ Depressed/ 2in1/ Ideal for Cordless angle grinder**



1. Cutting speed 10%up than 2in 1wheel.
2. Number of cut with 1 charge 80%up than 2in 1wheel.



Outer dia. mm	Thickness mm	Inner dia. mm	Grit	Range	Sales Pkg Qty	Part No.
100	2.2	16.00	SA46P	★★★★★	1	B-51649
115	2.0	22.23	SA46P	★★★★★	1	B-50360
125	2.2	22.23	SA46P	★★★★★	1	B-51655

**Cut-off wheel for Portable cut-off/ Metal**



Outer dia. mm	Thickness mm	Inner dia. mm	Grit	Range	Sales Pkg Qty	Part No.
305	3.0	25.40	A36P	★★★★	25	A-87650-25
	3.0	25.40	A36P	★★★★	25	A-88456-25
355	3.0	25.40	A30P	★★★★	5	B-16891-5
			A30P	★★★★	25	B-16891-25
	3.0	25.40	A30R	★★★★	5	B-20753-5
			A30R	★★★★	25	B-20753-25
	3.0	25.40	A30Q	★★★★	5	B-20775-5
			A30Q	★★★★	25	B-20775-25
	3.0	25.40	A36P	★★★★	5	A-89545-5
			A36P	★★★★	5	A-89953-5
	3.0	25.40	A36P	★★★★	25	A-89953-25
			A36P	★★★★	5	B-10665-5
	3.0	25.40	A36P	★★★★	25	B-10665-25
			A36P	★★★★	5	B-10730-5
	3.0	25.40	A36P	★★★★	25	B-10730-25
			A36P	★★★★	5	B-19881-5
3.0	25.40	A36P	★★★★	25	B-19881-25	
		A36P	★★★★	25	A-87585-25	
3.0	25.40	A36P	★★★★	25	A-87672-25	
		A36P	★★★★	25	A-89545-25	
3.0	25.40	A36T	★★★	25	E-10540-25	
		A36P	★★★★	25	A-87694-25	
405	3.0	25.40	A36R	★★★★	25	A-88478-25
			A36R	★★★★	25	A-88478-25

**Cut-off wheel for Portable cut-off/ Metal/ Fast cut-off**



Outer dia. mm	Thickness mm	Inner dia. mm	Grit	Range	Sales Pkg Qty	Part No.
355	3.0	25.40	A30P	★★★★	5	B-64353-5
					25	B-64353-25

**Cut-off wheel for Portable cut-off/ Metal stud/ Ideal for Cordless Portable cut-off**



Outer dia. mm	Thickness mm	Inner dia. mm	Grit	Range	Sales Pkg Qty	Part No.
355	2.5	25.40	A36P	Specialized	5	B-64696-5
					25	B-64696-25

Bonded Abrasive

### Cut-off wheel for Portable cut-off/ Stainless



1. The optimum bonding  
Heat-resistance property provides long life.

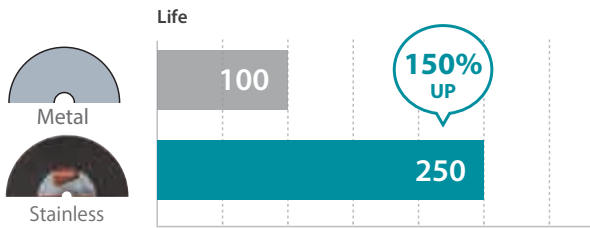

Outer dia. mm	Thickness mm	Inner dia. mm	Grit	Range	Sales Pkg Qty	Part No.
305	3.0	25.40	A30P	★★★	5	B-64571-5
					25	B-64571-25
355	2.8	25.40	A30P	★★★	5	B-64565-5
					25	B-64565-25

### Cut-off wheel for Portable cut-off/ Aluminium



1. Minimize clogging

Minimize clogging which caused by the heat when you cut-off the material by adding special additive to the cut-off wheel.

Clog will occur when you cut aluminum with cut-off wheel which is not for aluminum



Outer dia. mm	Thickness mm	Inner dia. mm	Grit	Range	Sales Pkg Qty	Part No.
305	3.0	25.40	AC30P	Specialized	5	E-04961-5
					25	E-04961-25

### Cut-off wheel for Portable cut-off/ Aluminium/ Ideal for Cordless Portable cut-off



Outer dia. mm	Thickness mm	Inner dia. mm	Grit	Range	Sales Pkg Qty	Part No.
355	2.8	25.40	AC30P	Specialized	5	E-04977-5
					25	E-04977-25

### Thin cut-off wheel for Portable cut-off/ Metal



1. Thinner blade & the optimum bonding

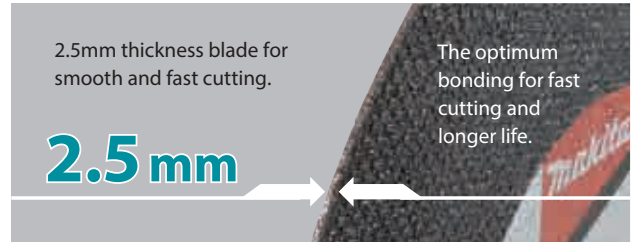

2. Ideal for cordless tools

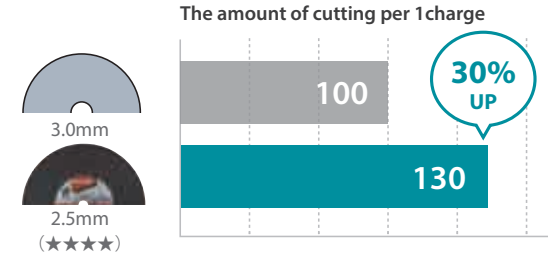

B-49448: For high voltage machine, B-57607: For low voltage machine

Outer dia. mm	Thickness mm	Inner dia. mm	Grit	Range	Sales Pkg Qty	Part No.
355	2.5	25.40	A36P	★★★★	5	B-49448-5
					25	B-49448-25
355	2.5	25.40	A36N	★★★★	5	B-57607-5
					25	B-57607-25
355	2.4	25.40	A30Q	★★★	5	B-20769-5
					25	B-20769-25

### Cut-off wheel for Power cutter/ Metal/ Ideal for Cordless Power cutter



Outer dia. mm	Thickness mm	Inner dia. mm	Grit	Range	Sales Pkg Qty	Part No.
355	4.3	25.40	A24T	★★★★	5	E-12790-5

### Grinding wheel for Straight grinder

For Metal



Outer dia. mm	Thickness mm	Inner dia. mm	Grit	Range	Sales Pkg Qty	Part No.
125	20.0	20.00	A24P	★★★	1	B-28662
	20.0	20.00	A36P	★★★★	1	B-28678
150	20.0	12.70	A24P	★★★★	1	B-34017
	20.0	12.70	A36P	★★★★	1	B-34023
150	20.0	20.00	A24P	★★★★	1	B-28684
	20.0	20.00	A36P	★★★★	1	B-28690

### Grinding wheel for Bench grinder



Outer dia. mm	Thickness mm	Inner dia. mm	Grit	Range	Sales Pkg Qty	Part No.
150	6.4	12.70	A60	★★★★	1	A-47195
150	6.4	12.70	A60M	★★★★	1	B-51895
150	16.0	12.70	A36M	★★★★	1	B-51904
150	16.0	12.70	A60M	★★★★	1	B-51910
150	16.0	12.70	GC120H	★★★★	1	B-51932
150	16.0	12.70	WA60K	★★★★	1	B-51926
205	19.0	15.88	A36P	★★★★	1	B-51948
205	19.0	15.88	A60P	★★★★	1	B-51954
205	19.0	15.88	GC120H	★★★★	1	B-51976
205	19.0	15.88	WA60K	★★★★	1	B-51960

### Dressing stone



Thickness mm	Grit	Note	Range	Sales Pkg Qty	Part No.
10.0	GC600	100x16mm	★★★★	1	A-24642
19.0	A1200	100x25mm	★★★★	1	794063-3
20.0	A1200	180x70mm	★★★★	1	794060-9
20.0	A1200	150x70mm	★★★★	1	794061-7

### Wheel point

Application  
 A: Mild steel, carbon steel, etc  
 WA: Hardend steels



Shape	Grit	Bit dia. mm	Working length mm	Shank mm	Range	Sales Pkg Qty	Part No.
Sphere	A60P	5	5.0	3	★★★★	10	794058-6
	A60P	10	13.0	3	★★★★	10	794059-4
Cylinder	A60P	5	13.0	3	★★★★	10	794050-2
	A60P	6	13.0	3	★★★★	10	794051-0
	A60P	8	13.0	3	★★★★	10	794052-8
	A60P	10	13.0	3	★★★★	10	794053-6
	WA60P	5	13.0	3	★★★★	10	794054-4
	WA60P	6	13.0	3	★★★★	10	794055-2
	WA60P	8	13.0	3	★★★★	10	794056-0
	WA60P	10	13.0	3	★★★★	10	794057-8

### Tungsten carbide burrs

#### Cut and application

##### Standard cut

<Feature> High efficiency  
 <Surface> Rough  
 <Material> Metal, Stainless



##### Diamond cut

<Feature> Less vibration  
 <Surface> Smooth  
 <Material> Metal, Stainless



##### Non-ferrous cut

<Feature> Less clogging up  
 <Surface> Rough  
 <Material> Non-ferrous, Plastic



#### Shape and application

Shape : SA



Shape : SC



Shape : SF



Shape : SL



Shape : SM



Clean the burrs on inox



Deburr of aluminium



Wipe the welding line between steel plate



### Tungsten carbide burrs/ mm type



Shape	Grit	Bit dia. mm	Working length mm	Shank mm	Range	Sales Pkg Qty	Part No.
SA	Diamond cut	10	20	6	★★★★	10	B-52722-10
SC		10	20	6	★★★★	10	B-52750-10
SF		10	20	6	★★★★	10	B-52788-10
SL		10	25	6	★★★★	10	B-52819-10
SM	Standard cut	10	20	6	★★★★	10	B-52847-10
SA		10	20	6	★★★★	10	B-52716-10
SC		10	20	6	★★★★	10	B-52744-10
SF		10	20	6	★★★★	10	B-52772-10
SL	Non-ferrous cut	10	25	6	★★★★	10	B-52803-10
SM		10	20	6	★★★★	10	B-52831-10
SA		10	20	6	★★★★	10	B-52738-10
SC		10	20	6	★★★★	10	B-52766-10
SF	Non-ferrous cut	10	20	6	★★★★	10	B-52794-10
SL		10	25	6	★★★★	10	B-52825-10
SM		10	20	6	★★★★	10	B-52853-10

# ACCESSORIES

## Coated Abrasive



Metal, mild steel



Stainless steel



Non-ferrous metal



Wood



Mortar



Plaster\_mortar



Granite



Marble



Plastic



Plaster board



Glass



Removing paint



Removing paint from metal or polishing



Hook and loop type

## Flap Disc



### Backing Type



**Fiber glass backing**  
Standard backing type



**Nylon backing**  
For heavy duty

### Shape Type















**Flat**  
Effective for flat surface



**Angled**  
Effective for angles or corners

## Material chart

AA : Recommended    A : Acceptable

Description of Grit material		 Aluminum oxide	 Zirconia alumina	 Silicon carbide
Description of label color		Best for metal 	Best for INOX and metal 	Best for Masonry 
Wood		A		
Plastic		A		
Metal		AA	AA	
No ferrous		A	A	
INOX			A	
Masonry				AA

\*After reading instruction manual of grinder, please chose work material.

**Flap disc aluminum oxide/ Fiberglass backing/ Angled**



Outer dia. mm	Inner dia. mm	Grit	Range	Sales Pkg Qty	Part No.
100	16.00	A36	★★	1	D-26973
			★★	1	D-26989
		A40	★	1	D-63395
				10	D-63395-10
		A60	★★	1	D-26995
			★	1	D-63404
				10	D-63404-10
		A80	★★	1	D-27006
			★	1	D-63410
				10	D-63410-10
		A120	★★	1	D-27012
			★	1	D-63426
		10	D-63426-10		
115	22.23	A36	★★	1	D-27028
			★★	1	D-27034
		A40	★	1	D-63432
				10	D-63432-10
		A60	★★	1	D-27040
			★	1	D-63448
				10	D-63448-10
		A80	★★	1	D-27056
			★	1	D-63454
				10	D-63454-10
		A120	★★	1	D-27062
			★	1	D-63460
		10	D-63460-10		
125	22.23	A36	★★	1	D-27078
			★★	1	D-27084
		A40	★	1	D-63476
				10	D-63476-10
		A60	★★	1	D-27090
			★	1	D-63482
				10	D-63482-10
		A80	★★	1	D-27109
			★	1	D-63498
				10	D-63498-10
		A120	★★	1	D-27115
			★	1	D-63507
		10	D-63507-10		
180	22.23	A36	★★	1	D-27121
			★★	1	D-27137
		A40	★	1	D-63513
				10	D-63513-10
		A60	★★	1	D-27143
			★	1	D-63529
				10	D-63529-10
		A80	★★	1	D-27159
			★	1	D-63535
				10	D-63535-10
		A120	★★	1	D-27165
			★	1	D-63541
		10	D-63541-10		

Coated Abrasive

**Flap disc zirconia aluminum/ Fiberglass backing/ Angled/ For heavy Industries**



- High efficiency
  - Long life
  - Suitable for Industry use
- High-speed Grinding with high-power grinder.

**Efficiency**

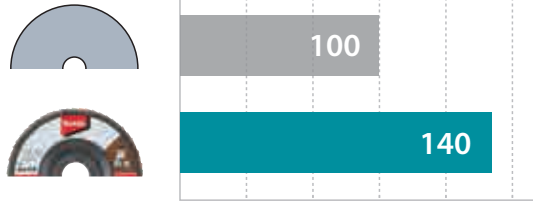

**Life**

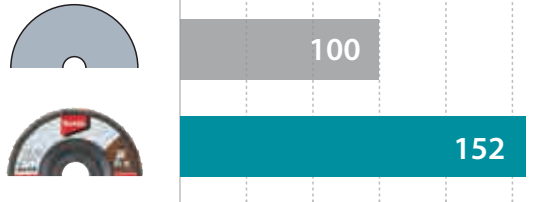

Outer dia. mm	Inner dia. mm	Grit	Range	Sales Pkg Qty	Part No.
115	22.23	Z40	★★★★	1	B-55603
		Z60	★★★★	1	B-55619
		Z80	★★★★	1	B-55625
125	22.23	Z120	★★★★	1	B-55631
		Z40	★★★★	1	B-53920
		Z60	★★★★	1	B-53936
180	22.23	Z80	★★★★	1	B-53942
		Z120	★★★★	1	B-53958
		Z40	★★★★	1	B-55647
		Z60	★★★★	1	B-55653
		Z80	★★★★	1	B-55669
		Z120	★★★★	1	B-55675

**Flap disc zirconia aluminum/ Fiberglass backing/ Angled**



Outer dia. mm	Inner dia. mm	Grit	Range	Sales Pkg Qty	Part No.
100	16.00	Z36	★★	1	D-27377
			★★	1	D-27383
		Z40	★	1	D-63703
				10	D-63703-10
		Z60	★★	1	D-27399
			★	1	D-63719
				10	D-63719-10
		Z80	★★	1	D-27408
			★	1	D-63725
				10	D-63725-10
		Z120	★★	1	D-27414
			★	1	D-63731
				10	D-63731-10

Outer dia. mm	Inner dia. mm	Grit	Range	Sales Pkg Qty	Part No.
115	22.23	Z36	★★	1	D-27420
			★	1	D-53718
		Z40	★★	1	D-27436
			★	1	D-53724
			★	1	D-63747
			★	10	D-63747-10
		Z60	★★	1	D-27442
			★	1	D-53730
			★	1	D-63753
			★	10	D-63753-10
		Z80	★★	1	D-27458
			★	1	D-53746
★	1		D-63769		
★	10		D-63769-10		
Z120	★★	1	D-27464		
	★	1	D-53752		
	★	10	D-63775-10		
125	22.23	Z36	★★	1	D-27470
			★★	1	D-27486
		Z40	★	1	D-63781
			★	10	D-63781-10
		Z60	★★	1	D-27492
			★	1	D-63797
		★	★	10	D-63797-10
			★★	1	D-27501
		Z80	★	1	D-63806
			★	10	D-63806-10
		Z120	★★	1	D-27517
			★	1	D-63812
★	10		D-63812-10		
180	22.23	Z36	★★	1	D-27523
			★★	1	D-27539
		Z40	★	1	D-63828
			★	10	D-63828-10
		Z60	★★	1	D-27545
			★	1	D-63834
		★	★	10	D-63834-10
			★★	1	D-27551
		Z80	★	1	D-63840
			★	10	D-63840-10
		Z120	★★	1	D-27567
			★	1	D-63856
★	10		D-63856-10		

**Flap disc zirconia aluminum/ Fiberglass backing/ Flat**



Outer dia. mm	Inner dia. mm	Grit	Range	Sales Pkg Qty	Part No.
100	16.00	Z40	★	1	D-74142
		Z60	★	1	D-74158
		Z80	★	1	D-74164
		Z120	★	1	D-74170
115	22.23	Z40	★	1	D-74186
		Z60	★	1	D-74192
		Z80	★	1	D-74201
125	22.23	Z120	★	1	D-74217
		Z40	★	1	D-74223
		Z60	★	1	D-74239
180	22.23	Z80	★	1	D-74245
		Z120	★	1	D-74251
		Z40	★	1	D-74267
180	22.23	Z60	★	1	D-74273
		Z80	★	1	D-74289
		Z120	★	1	D-74295

**Flap disc silicon carbide/ Fiberglass backing/ Flat**



Outer dia. mm	Inner dia. mm	Grit	Range	Sales Pkg Qty	Part No.
100	16.00	C36	★★	1	D-27975
		C40	★★	1	D-27981
		C60	★★	1	D-27997
		C80	★★	1	D-28008
115	22.23	C120	★★	1	D-28014
		C36	★★	1	D-28020
		C40	★★	1	D-28036
		C60	★★	1	D-28042
125	22.23	C80	★★	1	D-28058
		C120	★★	1	D-28064
		C36	★★	1	D-28070
		C40	★★	1	D-28086
180	22.23	C60	★★	1	D-28092
		C80	★★	1	D-28101
		C120	★★	1	D-28117
		C36	★★	1	D-28123
		C40	★★	1	D-28139
		C60	★★	1	D-28145
180	22.23	C80	★★	1	D-28151
		C120	★★	1	D-28167

**Flexible flap disc aluminum oxide/ Flat**

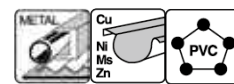

High flexibility



Suitable for grinding on CURVE/EDGE/CORNER surface.



Outer dia. mm	Inner dia. mm	Grit	Range	Sales Pkg Qty	Part No.
100	16.00	A40	★★	1	D-62686
		A60	★★	1	D-62692
		A80	★★	1	D-62701
		A120	★★	1	D-62717

**Strip disc**

Special tool for stripping work

**Grit (SiC)**

It is covered with glue with Sic (Silicon Carbide), so it enables you to grind quickly with less power.

**Fiber**

Entangled fiber acts as a cushion material and prevents from grinding too much and scratching steel.

The surface condition of strip disc is the finest.



Removing Paint, Removing Rust, Removing blue weld discoloration



Type	Color	Speed	Life
Standard	Black	100%	100%
Long life	Purple	94%	130%

**Strip disc/ Fiberglass backing/ Long life**



Outer dia. mm	Inner dia. mm	Grit	Range	Sales Pkg Qty	Part No.
100	16.00	Purple (Long life)	★★★★	1	B-29000
115	22.23		★★★★	1	B-29016
125	22.23		★★★★	1	B-29022
180	22.23		★★★★	1	B-29038

**Strip disc/ Nylon backing/ Long life**



Outer dia. mm	Inner dia. mm	Grit	Range	Sales Pkg Qty	Part No.
100	16.00	Purple (Long life)	★★★★	1	B-36245
115	22.23		★★★★	1	B-36251
125	22.23		★★★★	1	B-36267
180	22.23		★★★★	1	B-36273

**Strip disc/ Fiberglass backing**



Outer dia. mm	Inner dia. mm	Grit	Range	Sales Pkg Qty	Part No.
100	16.00	Black (Standard)	★★★	1	B-28961
115	22.23		★★★	1	B-28977
125	22.23		★★★	1	B-28983
180	22.23		★★★	1	B-28999

**Strip disc/ Nylon backing**



Outer dia. mm	Inner dia. mm	Grit	Range	Sales Pkg Qty	Part No.
100	16.00	Black (Standard)	★★★	1	B-29044
115	22.23		★★★	1	B-29050
125	22.23		★★★	1	B-29066
180	22.23		★★★	1	B-36239

**Surface conditioning flap disc**

1. Grinding and surface conditioning of metal in one step.
2. Suitable for polishing after grinding by flap disc.
3. Usable for stainless and metal.

**How to use**



Removing blue weld discoloration      Removing Rust

**Polishing after grinding by flap disc**

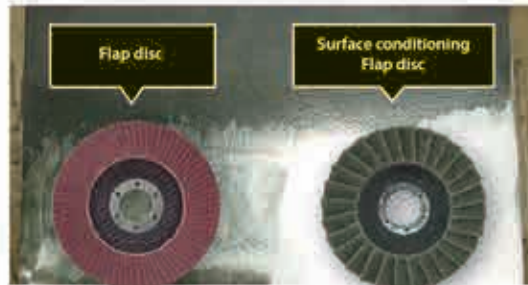

**Surface conditioning flap disc/ Angled/ Coarse**



Outer dia. mm	Inner dia. mm	Grit	Range	Sales Pkg Qty	Part No.
100	16.00	Coarse	★★★	1	B-40711
115	22.23		★★★	1	B-40755
125	22.23		★★★	1	B-40799
180	22.23		★★★	1	B-40836

**Surface conditioning flap disc/ Angled/ Medium**

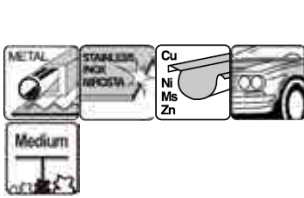

Outer dia. mm	Inner dia. mm	Grit	Range	Sales Pkg Qty	Part No.
100	16.00	Medim	★★★	1	B-40727
115	22.23		★★★	1	B-40761
125	22.23		★★★	1	B-40808
180	22.23		★★★	1	B-40842

**Surface conditioning flap disc/ Flat/ Medium**

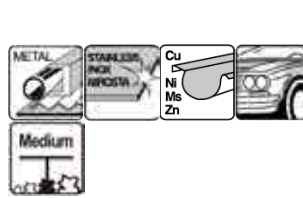

Outer dia. mm	Inner dia. mm	Grit	Range	Sales Pkg Qty	Part No.
100	16.00	Medim	★★★	1	B-40886
115	22.23	Medim	★★★	1	B-40923
125	22.23	Medim	★★★	1	B-40967
180	22.23	Medim	★★★	1	B-41006

**Surface conditioning flap disc/ Angled/ Fine**

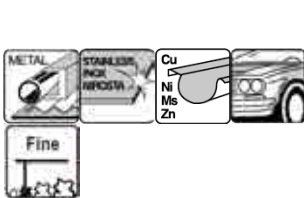

Outer dia. mm	Inner dia. mm	Grit	Range	Sales Pkg Qty	Part No.
100	16.00	Fine	★★★	1	B-40733
115	22.23		★★★	1	B-40777
125	22.23		★★★	1	B-40814
180	22.23		★★★	1	B-40858

**Surface conditioning flap disc/ Flat/ Fine**

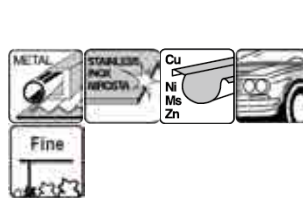

Outer dia. mm	Inner dia. mm	Grit	Range	Sales Pkg Qty	Part No.
100	16.00	Fine	★★★	1	B-40892
115	22.23	Fine	★★★	1	B-40939
125	22.23	Fine	★★★	1	B-40973
180	22.23	Fine	★★★	1	B-41012

**Surface conditioning flap disc/ Angled/ Very fine**

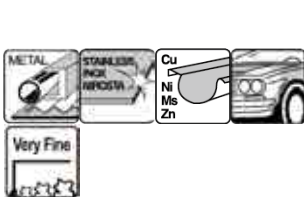

Outer dia. mm	Inner dia. mm	Grit	Range	Sales Pkg Qty	Part No.
100	16.00	Very Fine	★★★	1	B-40749
115	22.23	Very Fine	★★★	1	B-40783
125	22.23	Very Fine	★★★	1	B-40820
180	22.23	Very Fine	★★★	1	B-40864

**Surface conditioning flap disc/ Flat/ Very fine**

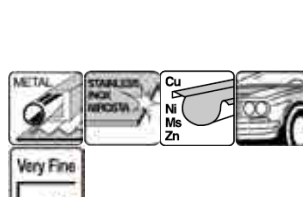

Outer dia. mm	Inner dia. mm	Grit	Range	Sales Pkg Qty	Part No.
100	16.00	Very Fine	★★★	1	B-40901
115	22.23	Very Fine	★★★	1	B-40945
125	22.23	Very Fine	★★★	1	B-40989
180	22.23	Very Fine	★★★	1	B-41028

**Surface conditioning flap disc/ Flat/ Coarse**

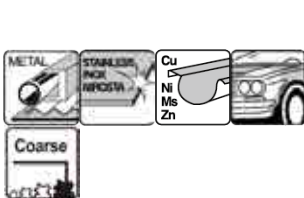

Outer dia. mm	Inner dia. mm	Grit	Range	Sales Pkg Qty	Part No.
100	16.00	Coarse	★★★	1	B-40870
115	22.23	Coarse	★★★	1	B-40917
125	22.23	Coarse	★★★	1	B-40951
180	22.23	Coarse	★★★	1	B-40995

**Fiber sanding disc**



Size mm	Grit	Model No.	Range	Sales Pkg Qty	Part No.
100x22	C24	-	★★★★	10	794065-9
	C50	-	★★★★	10	794067-5
	C80	-	★★★★	10	794068-3
	C100	-	★★★★	10	794227-9
	C120	-	★★★★	10	794069-1
115x22	C24	-	★★★★	10	794104-5
	C30	-	★★★★	10	794105-3
125x12.7	C120	-	★★★★	10	794108-7
	A50	GV5010	★★★★	5	794319-4
125x22	A80	GV5010	★★★★	5	794320-9
	C24	-	★★★★	10	794096-8
	C50	-	★★★★	10	794098-4
	C80	-	★★★★	10	794099-2
	C120	-	★★★★	10	794100-3
150x12.7	C50	GV6010	★★★★	10	794086-1
	C80	GV6010	★★★★	10	794088-7
	C120	GV6010	★★★★	10	794090-0
150x22	A80	-	★★★★	25	B-66765-25
	C24	-	★★★★	10	794070-6
	C30	-	★★★★	10	794071-4
	C50	-	★★★★	10	794072-2
	C80	-	★★★★	10	794073-0
	C100	-	★★★★	10	794219-8
	C120	-	★★★★	10	794074-8
180x22	C16	-	★★★★	10	794091-8
	C30	-	★★★★	10	794218-0
	C50	-	★★★★	10	794094-2
	C50	-	★★★★	25	B-66771-25
	C80	-	★★★★	25	B-66787-25
C100	-	★★★★	10	794220-3	

**Fiber sanding disc for wet**



Size mm	Grit	Model No.	Range	Sales Pkg Qty	Part No.
125x22	C24	PK5001C,	★★★★	10	B-14526
125x22	C50		★★★★	10	B-14532
125x22	C80	PK5011C	★★★★	10	B-14548
125x22	C120		★★★★	10	B-14554

**Accessory for DPV300 (Sander Polisher)**

**How to use**

1. Use with adapter (743126-2)
2. Use with pad (743124-6)

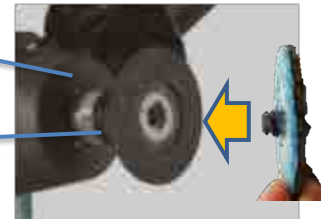

**Fiber sanding disc for DPV300**



Dia mm	Grit	Range	Sales Pkg Qty	Part No.
50	A60	★★★★	25	E-07412
50	A80	★★★★	25	E-07428
50	A120	★★★★	25	E-07434
50	Z60	★★★★	25	E-07440
50	Z80	★★★★	25	E-07456

**Surface conditioning disc for DPV300**



Dia mm	Grit Type	Grit	Range	Sales Pkg Qty	Part No.
50	Hard: Surface polishing, Removing paint and rust	Coarse	★★★★	25	E-07462
50		Medium	★★★★	25	E-07478
50		Fine	★★★★	25	E-07484
50	Soft: Surface polishing	Medium	★★★★	25	E-07490
50		Fine	★★★★	25	E-07509
50		Very fine	★★★★	25	E-07515

**Abrasive disc/ Wood**



Dia mm	Grit	Holes	fastening	Range	Sales Pkg Qty	Part No.
125	A40	8	Hook & Loop	★★	10	D-54134
	A40			★★	50	D-54673
	A60			★★	10	D-54140
	A60			★★	50	D-54689
	A80			★★	10	D-54156
	A80			★★	50	D-54695
	A100			★★	10	D-54162
	A100			★★	50	D-54704
	A120			★★	10	D-54178
	A120			★★	50	D-54710
	A150			★★	10	D-54184
	A150			★★	50	D-54726
	A180			★★	10	D-54190
	A180			★★	50	D-54732
	A240			★★	10	D-54209
	A240			★★	50	D-54748
A320	★★	10	D-54215			
A320	★★	50	D-54754			

Dia mm	Grit	Holes	fastening	Range	Sales Pkg Qty	Part No.
150	A40	15	Hook & Loop	★★★	10	B-51415
	A40			★★	10	D-54586
	A40			★★	50	D-54760
	A60			★★★	10	B-51421
	A60			★★	10	D-54592
	A60			★★	50	D-54776
	A80			★★★	10	B-51437
	A80			★★	10	D-54601
	A80			★★	50	D-54782
	A100			★★★	10	B-51443
	A100			★★	10	D-54617
	A100			★★	50	D-54798
	A120			★★★	10	B-51459
	A120			★★	10	D-54623
	A120			★★	50	D-54807
	A150			★★	10	D-54639
	A150			★★	50	D-54813
	A180			★★★	10	B-51465
	A180			★★	10	D-54645
	A180			★★	50	D-54829
	A240			★★★	10	B-51471
	A240			★★	10	D-54651
	A240			★★	50	D-54835
	A320			★★★	10	B-51487
A320	★★	10	D-54667			
A320	★★	50	D-54841			
A400	★★★	10	B-51493			

**Abrasive disc/ Wood/ Metal**



Dia mm	Grit	Holes	fastening	Range	Sales Pkg Qty	Part No.
125	WA60	8	Hook & Loop	★★★	10	794542-1
	WA80	8		★★★	10	794543-9
	WA120	8		★★★	10	794544-7
	WA180	8		★★★	10	794545-5
	WA240	8		★★★	10	794546-3
150	WA60	9	Hook & Loop	★★★	10	794608-7
	WA80	9		★★★	10	794609-5
	WA120	9		★★★	10	794610-0
	WA180	9		★★★	10	794611-8
	WA240	9		★★★	10	794612-6
	WA400	9		★★★	10	794613-4

**Abrasive disc/ Paint**



Dia mm	Grit	Holes	fastening	Range	Sales Pkg Qty	Part No.
125	A40	8	Hook & Loop	★★	10	D-65816
	A60	8		★★	10	D-65822
	A80	8		★★	10	D-65838
	A100	8		★★	10	D-65844
	A120	8		★★	10	D-65850
	A150	8		★★	10	D-65866
	A180	8		★★	10	D-65872
	A240	8		★★	10	D-65888
	A320	8		★★	10	D-65894
	A400	8		★★	10	D-65903

Dia mm	Grit	Holes	fastening	Range	Sales Pkg Qty	Part No.
150	A40	15	Hook & Loop	★★★	10	B-51502
	A60	15		★★★	10	B-51518
	A80	15		★★★	10	B-51524
	A100	15		★★★	10	B-51530
	A120	15		★★★	10	B-51546
	A180	15		★★★	10	B-51552
	A240	15		★★★	10	B-51568
	A320	15		★★★	10	B-51574
	A400	15		★★★	10	B-51580

**Abrasive disc/ Drywall**

225 mm abrasive paper for Dry wall sander



Dia mm	Grit	Holes	fastening	Range	Sales Pkg Qty	Part No.
225	A40	9	Hook & Loop	★★★★	25	B-68389
	A80	9		★★★★	25	B-68395
	A120	9		★★★★	25	B-68404
	A150	9		★★★★	25	E-02375
	A180	9		★★★★	25	B-68410
	A220	9		★★★★	25	E-02381
	A320	9		★★★★	25	B-68426

**Abrasive belt/ Wood**



Size mm	Grit	Range	Sales Pkg Qty	Part No.
30x533	A40	★★	5	D-67066
	A60	★★	5	D-67072
	A80	★★	5	D-67088
	A100	★★	5	D-67094
	A120	★★	5	D-67103
	A150	★★	5	D-67119
	A180	★★	5	D-67125
76x457	A240	★★	5	D-67131
	A40	★★	3	D-59184
	A60	★★	3	D-59190
	A80	★★	3	D-59209
	A100	★★	3	D-59215
	A120	★★	3	D-59221
	A150	★★	3	D-59237
76x533	A180	★★	3	D-59243
	A240	★★	3	D-59259
	A40	★★	3	D-59265
	A60	★★	3	D-59271
	A80	★★	3	D-59287
	A100	★★	3	D-59293
	A120	★★	3	D-59302
76x610	A150	★★	3	D-59318
	A180	★★	3	D-59324
	A240	★★	3	D-59330
	A40	★★	3	D-67147
	A60	★★	3	D-67153
	A80	★★	3	D-67169
	A100	★★	3	D-67175
76x610	A120	★★	3	D-67181
	A150	★★	3	D-67197
	A180	★★	3	D-67206
	A240	★★	3	D-67212

Size mm	Grit	Range	Sales Pkg Qty	Part No.
100x610	A40	★★	3	D-59346
	A60	★★	3	D-59352
	A80	★★	3	D-59368
	A100	★★	3	D-59374
	A120	★★	3	D-59380
	A150	★★	3	D-59396
	A180	★★	3	D-59405
	A240	★★	3	D-59411

**Abrasive belt/ Wood/ Metal**

For use with Belt Sander



Size mm	Grit	Range	Sales Pkg Qty	Part No.
6x533	A40	★★★	10	A-34512
	A60	★★★	10	A-34528
	A80	★★★	10	A-34534
	A100	★★★	10	A-34540
	A120	★★★	10	A-34556
9x533	A40	★★★	10	A-34447
	A60	★★★	10	A-34453
	A80	★★★	10	A-34469
	A100	★★★	10	A-34475
13x533	A40	★★★	10	A-34481
	A60	★★★	10	A-34487
	A80	★★★	10	A-34493
	A100	★★★	10	A-34499
76x457	WA80	★★★	10	794551-0
76x533	WA60	★★★	10	794120-7
76x610	WA150	★★★	10	794242-3
	WA180	★★★	10	794243-1
	WA240	★★★	10	794244-9
100x610	WA40	★★★	5	794133-8
	WA60	★★★	5	794134-6
	WA80	★★★	5	794135-4
	WA100	★★★	5	794136-2
	WA120	★★★	5	794137-0
	WA150	★★★	5	794138-8
	WA180	★★★	5	794222-9
	WA240	★★★	5	794139-6

Coated Abrasive

**Abrasive paper/ Wood/ Metal**



Size mm	Grit	Holes	fastening	Range	Sales Pkg Qty	Part No.
93x228	WA60	-	Clamp	★★★	10	794156-6
	WA80	-		★★★	10	794471-8
	WA100	-		★★★	10	794157-4
	WA150	-		★★★	10	794158-2
93x228	WA60	8		★★★	10	A-31245
	WA80	8		★★★	10	A-31251
	WA120	8		★★★	10	A-31267
	WA180	8		★★★	10	A-31273
	WA240	8		★★★	10	A-31289
114x140	WA60	-		★★★	10	794216-460
	WA80	-		★★★	10	794469-5
	WA100	-		★★★	10	794215-660
114x280	WA150	-		★★★	10	794214-8
	WA60	-		★★★	10	794210-6
	WA80	-		★★★	10	794470-0
	WA100	-		★★★	10	794209-1
	WA120	-	★★★	10	794212-2	
115x280	WA150	-	★★★	10	794213-0	
	WA180	-	★★★	10	794211-4	
	WA60	10	★★★	10	A-14065	
	WA80	10	★★★	10	A-14071	
	WA100	10	★★★	10	A-14087	
	WA120	10	★★★	10	A-14093	
	WA150	10	★★★	10	A-14102	
	WA180	10	★★★	10	A-14118	
	WA240	10	★★★	10	A-14124	
	115x232	WA60	10	Hook & Loop	★★★	5
WA80		10	★★★		5	A-14146
WA100		10	★★★		5	A-14152
WA120		10	★★★		5	A-14168
WA150		10	★★★		5	A-14174
WA180		10	★★★		5	A-14180
WA240	10	★★★	5	A-14196		

**Abrasive paper/ Paint**



**Abrasive paper/ Wood**



Size mm	Grit	Holes	fastening	Range	Sales Pkg Qty	Part No.
114x102	A40	6	Hook & Loop	★★	10	D-58665
	A60	6		★★	10	D-58671
	A80	6		★★	10	D-58687
	A100	6		★★	10	D-58693
	A120	6		★★	10	D-58702
	A150	6		★★	10	D-58718
	A180	6		★★	10	D-58724
	A240	6		★★	10	D-58730
	A320	6		★★	10	D-58746

Size mm	Grit	Holes	fastening	Range	Sales Pkg Qty	Part No.
93x228	A80	8	Clamp	★★	10	D-65252
	A100	8		★★	10	D-65268
	A120	8		★★	10	D-65274
	A180	8		★★	10	D-65280
	A240	8		★★	10	D-65296
	A320	8		★★	10	D-65305
114x140	A80	6		★★	10	D-65311
	A100	6		★★	10	D-65327
	A120	6		★★	10	D-65333
	A180	6		★★	10	D-65349
	A240	6		★★	10	D-65355
	A320	6		★★	10	D-65361

### Abrasive paper 230 x 280mm

#### How to use

1/2 sheet

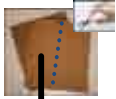

BO4900 etc

1/3 sheet



BO3710 etc

1/4 sheet



BO4555 etc

### Abrasive paper sheet/ Wood



Size mm	Grit	fastening	Range	Sales Pkg Qty	Part No.
230x280	40	Clamp	★	10	D-66313
				50	D-51683
	60		★	10	D-66329
				50	D-51699
	80		★	10	D-66335
				50	D-51708
	100		★	10	D-66341
				50	D-51714
	120		★	10	D-66357
				50	D-51720
	150		★	10	D-66363
				50	D-51736
	180		★	10	D-66379
				50	D-51742
	240		★	10	D-66385
				50	D-51758
320	★	10	D-66391		
		50	D-56873		
400	★	10	D-66400		
		50	D-56889		

### Abrasive paper sheet/ Metal

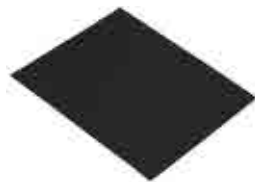

Size mm	Grit	fastening	Range	Sales Pkg Qty	Part No.
230x280	36	Clamp	★	10	D-66488
				50	D-56677
	40		★	10	D-66494
				50	D-56683
	60		★	10	D-66503
				50	D-56699
	80		★	10	D-66519
				50	D-56708
	100		★	10	D-66525
				50	D-56714
	120		★	10	D-66531
				50	D-56720
	150		★	10	D-66547
				50	D-56736
	180		★	10	D-66553
				50	D-56742
240	★	10	D-66569		
		50	D-56758		

### Abrasive paper sheet/ Mortar



Size mm	Grit	fastening	Range	Sales Pkg Qty	Part No.
230x280	60	Clamp	★	10	D-66416
				50	D-56530
	80		★	10	D-66422
				50	D-56546
	100		★	10	D-66438
				50	D-56552
	120		★	10	D-66444
				50	D-56568
	150		★	10	D-66450
				50	D-56574
	180		★	10	D-66466
				50	D-56580
240	★	10	D-66472		
		50	D-56596		

### Abrasive paper sheet/ Paint



Size mm	Grit	fastening	Range	Sales Pkg Qty	Part No.
230x280	80	Clamp	★★	10	D-66086
				100	D-60698
	100		★★	10	D-66092
				100	D-60707
	120		★★	10	D-66101
				100	D-60713
	150		★★	10	D-66117
				100	D-60729
	180		★★	10	D-66123
				100	D-60735
	240		★★	10	D-66145
				100	D-60757
320	★★	100	D-60779		
	400	★★	100	D-60791	

### Abrasive paper sheet/ Carbody/ Waterproof

Wet: Hand-use only



Size mm	Grit	fastening	Range	Sales Pkg Qty	Part No.
230x280	120	Clamp	★	10	D-66189
				50	D-58964
	180		★	10	D-66204
				50	D-58986
	280		★	10	D-66226
				50	D-59003
	320		★	10	D-66232
				50	D-59019
	600		★	10	D-66254
				50	D-59031
	800		★	10	D-66260
				50	D-59047
	1000		★	10	D-66276
				50	D-59053
	1500		★	10	D-66298
				50	D-59069
2000	★	10	D-66307		
		50	D-59075		

**Abrasive delta paper/ Wood**



Size mm	Grit	fastening	Range	Sales Pkg Qty	Part No.	
94	40	Hook & Loop	★★	10	D-58578	
94	60		★★★	10	B-21624	
94	60		★★	10	D-58584	
94	80		★★★	10	B-21630	
94	80		★★	10	D-58590	
94	100		★★★	10	B-22947	
94	100		★★	10	D-58609	
94	120		★★★	10	B-21646	
94	120		★★	10	D-58615	
94	150		★★★	10	B-22953	
94	150		★★	10	D-58621	
94	180		★★★	10	B-21652	
94	180		★★	10	D-58637	
94	240		★★★	10	B-21668	
94	240		★★	10	D-58643	
94	320		★★	10	D-58659	
94	Aassort 60, 80, 120, 180, 240			★★★	10	B-21618

**Abrasive delta paper/ Wood/ long-life**



Size mm	Grit	fastening	Range	Sales Pkg Qty	Part No.
94	60	Hook & Loop	★★★★	10	B-21565
94	80		★★★★	10	B-21571
94	100		★★★★	10	B-21587
94	120		★★★★	10	B-21593
94	180		★★★★	10	B-21602
94	240		★★★★	10	B-22931
94	Aassort 60, 80, 100, 120, 180		★★★★	10	B-21559

**Abrasive delta paper/ Paint**



Size mm	Grit	fastening	Range	Sales Pkg Qty	Part No.
94	60	Hook & Loop	★★★★	10	B-21680
94	80		★★★★	10	B-21696
94	100		★★★★	10	B-21705
94	120		★★★★	10	B-22969
94	240		★★★★	10	B-21711
94	320		★★★★	10	B-21727
94	Aassort 60, 80, 100, 240, 320		★★★★	10	B-21674

**Abrasive delta paper/ Stone**



Size mm	Grit	fastening	Range	Sales Pkg Qty	Part No.
94	120	Hook & Loop	★★★	10	B-21749
94	240		★★★	10	B-21755
94	400		★★★	10	B-21761
94	600		★★★	10	B-21777
94	1200		★★★	10	B-21783
94	Aassort 120, 240, 400, 600, 1200			★★★	10

**Abrasive delta paper/ Polishing fleece**

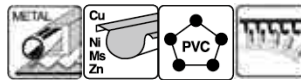

Size mm	Grit	fastening	Range	Sales Pkg Qty	Part No.
94	100	Hook & Loop	★★★★	1	B-21808
94	280		★★★★	1	B-21799
94	-		★★★★	1	B-21814

**Abrasive delta paper/ Polishing felt**



Size mm	fastening	Range	Sales Pkg Qty	Part No.
94	Hook & Loop	★★★★	1	B-21820

**Abrasive paper for JR1000FT**



Size mm	Grit	fastening	Range	Sales Pkg Qty	Part No.
22x95	10	Hook & Loop	★★★★	10	B-04983

# ACCESSORIES

## Multi Tool



Metal, mild steel



Sheet metal



Stainless steel



Aluminum



Wood



Wood with nails



Plywood



Tile



Concrete block



Limestone



Plastic



Epoxy



Fiberglass



Plaster board



Silicon



Carpet



Insulation



Hook and loop type





Multi Material						Grout Abrasive		
Epoxy	Fiber glass	Linoleum Carpet	Carpet adhesive	Insulation material	Soft joint material	Porous Concrete Soft brick	Soft wall tiles	Mortar Tile adhesive
✓	✓							
✓	✓							
✓	✓							
✓	✓							
✓	✓							
✓	✓							
✓								
✓								
✓								
✓	✓							
✓	✓							
✓	✓							
✓	✓							
✓	✓							
		✓	✓	✓				
✓	✓							
			✓					
			✓					
					✓			
		✓	✓	✓				
✓	✓							
✓								
✓								
✓								
✓	✓					✓		✓
✓	✓					✓		✓
✓	✓					✓		✓
✓	✓					✓		✓
✓								✓
✓	✓					✓	✓	✓
	✓							✓
	✓							✓

Curve Teeth	Blade Material	Teeth per inch	Width (mm)	
	BiM	18	85	TMA045
	BiM	15	100	TMA046
●	BiM	20	32	TMA047
●	BiM	20	65	TMA048
	BiM	20	10	TMA057
	BiM	20	20	TMA058
	HCS	18	85	TMA049
	HCS	18	24	TMA050
●	HCS	18	32	TMA051
●	HCS	20	65	TMA052
●	BiM	14	32	TMA053
●	HCS	14	32	TMA054
●	BiM	14	65	TMA055
●	HCS	14	65	TMA056
	BiM	20	32	TMA059
	TC	23	20	TMA060
	TC	23	32	TMA061
	TC	23	45	TMA079
	BiM	-	100	TMA063
	BiM	18	85	TMA064
	HCS	-	52	TMA065
	HCS	-	52	TMA066
	HCS	-	28	TMA067
	HCS	-	11	TMA068
●	TC	20	32	TMA080
●	BiM	14	53	TMA081
	Stainless	-	12	TMA082
	TC #30	-	85	TMA069
	Diamond	-	85	TMA070
	TC #50	-	70	TMA071
	TC #40	-	85	TMA072
	TC #20	-	78	TMA073
	TC #40	-	70	TMA074
	TC #50	-	32	TMA075
	TC #40	-	32	TMA076
	TC #100	-	32	TMA077
	TC #20	-	90	TMA083
	TC #40	-	90	TMA084
	TC #60	-	90	TMA085
	TC #100	-	90	TMA086

Color coding for application



Wood & Metal



Wood



Metal



Multi Material



Grout Abrasive

Multi Tool

**STARLOCK PLUS** **STARLOCK MAX**



Rating Suitability for application:  
 ✓ = Suitable  
 Blank = No Rating

Color coding for application

Width (mm)	Teeth per inch	Blade Material	Curve Teeth
------------	----------------	----------------	-------------

Wood & Metal								
Wood					Metal			
Wood	Plywood	Chipboard	Laminate	Plaster board	Non ferrous metal	Sheet metal	Stainless	Soft nail

**STARLOCK PLUS**



Wood & Metal

MAP001	32	20	BiM	•
MAP002	65	20	BiM	•

✓	✓	✓	✓	✓	✓	✓		✓
✓	✓	✓	✓	✓	✓	✓		✓



Wood

MAP003	32	18	HCS	•
--------	----	----	-----	---

✓	✓	✓	✓					
---	---	---	---	--	--	--	--	--



Metal

MAP004	32	23	TC	
MAP005	45	23	TC	

✓	✓	✓	✓	✓	✓	✓	✓	✓
✓	✓	✓	✓	✓	✓	✓	✓	✓



Multi Material

MAP006	32	20	TC	•
MAP007	52	20	TC	•

✓	✓	✓	✓	✓	✓	✓	✓	✓
✓	✓	✓	✓	✓	✓	✓	✓	✓



Grout Abrasive

MAP008	53	-	TC #40	
--------	----	---	--------	--

✓		✓		✓	✓			✓
---	--	---	--	---	---	--	--	---

**STARLOCK MAX**



Wood & Metal

MAM001	32	20	BiM	•
MAM002	52	18	BiM	•
MAM003	100	15	BiM	

✓	✓	✓	✓	✓	✓	✓		✓
✓	✓	✓	✓	✓	✓	✓		✓
✓	✓	✓	✓		✓			✓



Wood

MAM004	32	18	HCS	•
--------	----	----	-----	---

✓	✓	✓	✓					
---	---	---	---	--	--	--	--	--



Metal

MAM005	32	23	TC	
--------	----	----	----	--

✓	✓	✓	✓	✓	✓	✓	✓	✓
---	---	---	---	---	---	---	---	---



Multi Material

MAM006	32	20	TC	•
MAM007	32	-	HCS	
MAM008	32	-	HCS	

✓	✓	✓	✓	✓	✓	✓	✓	✓



Grout Abrasive

MAM009	68	-	TC #50	
MAM010	68	-	TC #30	
MAM011	68	-	Diamond	
MAM012	68	-	Diamond	
MAM013	68	-	TC #40	
MAM014	100	-	TC #40	
MAM015	116	-	TC #20	
MAM016	116	-	TC #40	
MAM017	116	-	TC #60	
MAM018	116	-	TC #100	

				✓				
				✓				
				✓				
				✓				
				✓				
✓	✓			✓	✓			✓
✓	✓	✓						
✓	✓	✓						
✓	✓	✓						
✓	✓	✓						



Multi Material						Grout Abrasive			Curve Teeth	Blade Material	Teeth per inch	Width (mm)	Application Code
Epoxy	Fiber glass	Linoleum Carpet	Carpet adhesive	Insulation material	Soft joint material	Porous Concrete Soft brick	Soft wall tiles	Mortar Tile adhesive					
✓	✓								●	BiM	20	32	MAP001
✓	✓								●	BiM	20	65	MAP002
✓									●	HCS	18	32	MAP003
✓	✓					✓				TC	23	32	MAP004
✓	✓									TC	23	45	MAP005
✓	✓					✓			●	TC	20	32	MAP006
✓	✓					✓			●	TC	20	52	MAP007
✓						✓				TC #40	-	53	MAP008
✓	✓								●	BiM	20	32	MAM001
✓	✓								●	BiM	18	52	MAM002
✓										BiM	15	100	MAM003
									●	HCS	18	32	MAM004
✓	✓					✓				TC	23	32	MAM005
✓	✓					✓			●	TC	20	32	MAM006
					✓					HCS	-	32	MAM007
				✓	✓					HCS	-	32	MAM008
✓	✓					✓	✓	✓		TC #50	-	68	MAM009
✓	✓					✓	✓	✓		TC #30	-	68	MAM010
✓	✓					✓	✓	✓		Diamond	-	68	MAM011
✓	✓					✓	✓	✓		Diamond	-	68	MAM012
✓	✓					✓	✓	✓		TC #40	-	68	MAM013
✓	✓					✓		✓		TC #40	-	100	MAM014
	✓							✓		TC #20	-	116	MAM015
	✓							✓		TC #40	-	116	MAM016
								✓		TC #60	-	116	MAM017
								✓		TC #100	-	116	MAM018

Color coding for application





Compatibility with models		STARLOCK	STARLOCK PLUS	STARLOCK MAX
OIS Compatible Tools			-	-
STARLOCK MAX				

**Segment saw blade Starlock shank Wood and metal**

**STARLOCK**

Makita No.	Blade Width mm	Tpi	Material of Blade	Range	Sales Pkg Qty	Part No.
TMA045	85	18TPI	BiM	★★★	1	B-64799
TMA046	100	15TPI	BiM	★★★	1	B-64808

**Plunge cut saw blade Starlock shank Wood and metal**

**STARLOCK**

Makita No.	Blade Width mm	Tpi	Material of Blade	Note	Range	Sales Pkg Qty	Part No.
TMA047	32x50	20TPI	BiM	Bow shape	★★★	1	B-64814
					5	B-64814-5	
					20	B-64814-20	
TMA048	65x40				★★★	1	B-64820
					★★★	5	B-64820-5
TMA057	10x30				★★★	1	B-64917
TMA058	20x30	20TPI	BiM	-	★★★	1	B-64923
					★★★	5	B-64923-5

**Segment saw blade Starlock shank Wood**

**STARLOCK**

Makita No.	Blade Width mm	Tpi	Material of Blade	Range	Sales Pkg Qty	Part No.
TMA049	85	18TPI	HCS	★★★	1	B-64836

**Plunge cut saw blade Starlock shank Wood**

**STARLOCK**

Makita No.	Blade Width mm	Tpi	Material of Blade	Note	Range	Sales Pkg Qty	Part No.
TMA050	24x50	18TPI	HCS	-	★★★	1	B-64842
					★★★	5	B-64842-5
TMA051	32x50	18TPI	HCS	Bow shape	★★★	1	B-64858
					★★★	5	B-64858-5
					★★★	20	B-64858-20
TMA052	65x40	20TPI	HCS		★★★	1	B-64864
					★★★	5	B-64864-5
TMA053	32x50	14TPI	BiM	Bow shape, Japanese teeth Recommended Hard wood	★★★	1	B-64870
					5	B-64870-5	
					20	B-64870-20	
TMA055	65x40				★★★	1	B-64892
					★★★	5	B-64892-5
TMA054	32x50	14TPI	HCS	Bow shape, Japanese teeth	★★★	1	B-64886
					5	B-64886-5	
					1	B-64901	
TMA056	65x40				★★★	5	B-64901-5

**Plunge cut saw blade Starlock shank Metal**

**STARLOCK**

Makita No.	Blade Width mm	Tpi	Material of Blade	Range	Sales Pkg Qty	Part No.
TMA059	32x50	20TPI	BiM	★★★	1	B-64939
					5	B-64939-5

**TC bar plunge cut saw blade Starlock shank Metal**

**STARLOCK**

Makita No.	Blade Width mm	Tpi	Material of Blade	Range	Sales Pkg Qty	Part No.
TMA060	20x40	23TPI	TC/HM	★★★	1	B-64945
				5	B-64945-5	
TMA061	32x40			★★★	1	B-64951
				★★★	5	B-64951-5
TMA079	45x49			★★★	1	B-69755

**Segment saw blade Starlock shank Multi material**

**STARLOCK**

Makita No.	Blade Width mm	Tpi	Material of Blade	Range	Sales Pkg Qty	Part No.
TMA064	85	18TPI	BiM-TiN	★★★	1	B-64973

**Serrated segment blade Starlock shank Multi material**

**STARLOCK**

Makita No.	Blade Width mm	Material of Blade	Range	Sales Pkg Qty	Part No.
TMA063	100	BiM	★★★	1	B-64967

**Plunge and segment cut saw blade Starlock shank Multi material**

**STARLOCK**

Makita No.	Blade Width mm	Tpi	Material of Blade	Range	Sales Pkg Qty	Part No.
TMA081	53x40	14TPI	BiM	★★★	1	B-69777

**TC bar plunge cut saw blade Starlock shank Multi material**

**STARLOCK**

Makita No.	Blade Width mm	Tpi	Material of Blade	Note	Range	Sales Pkg Qty	Part No.
TMA080	32x40	20TPI	TC/HM	Bow shape	★★★	1	B-69761

**Joint cutter blade Starlock shank Multi material**

**STARLOCK**

Makita No.	Blade Width mm	Material of Blade	Range	Sales Pkg Qty	Part No.
TMA067	28x40	HCS	★★★	1	B-65006
				5	B-65006-5
TMA082	12x29	Stainless	★★★	1	B-69783

**Universal purpose knife Starlock shank Multi material**

**STARLOCK**

Makita No.	Blade Width mm	Material of Blade	Range	Sales Pkg Qty	Part No.
TMA068	11x24	HCS	★★★	1	B-65012

**Scraper blade Starlock shank Multi material**

**STARLOCK**

Makita No.	Blade Width mm	Material of Blade	Note	Range	Sales Pkg Qty	Part No.
TMA065	52x26	HCS	Rigid	★★★	1	B-64989
TMA066	52x40		Flexible	★★★	1	B-64995

**TC segment blade Starlock shank Grout abrasive**

**STARLOCK**

Makita No.	Blade Width mm	Material of Blade	Note	Range	Sales Pkg Qty	Part No.
TMA069	85	TC/HM #30	Blade thickness 2.5mm	★★★	1	B-65028
TMA071	70	TC/HM #50	Blade thickness 1.6mm	★★★	1	B-65040
TMA072	85	TC/HM #40	Blade thickness 1.7mm	★★★	1	B-65056

**Diamond segment blade Starlock shank Grout abrasive**



Makita No.	Blade Width mm	Material of Blade	Note	Range	Sales Pkg Qty	Part No.
TMA070	85	Diamond #40	Blade thickness 2.0mm	★★★	1	B-65034

**TC sanding plate Starlock shank Grout abrasive Pointer shape**



Makita No.	Blade Width mm	Material of Blade	Range	Sales Pkg Qty	Part No.
TMA076	32x50	TC/HM #40	★★★	1	B-65090
TMA077	32x50	TC/HM #100	★★★	1	B-65109

**TC plunge blade Starlock shank Grout abrasive**



Makita No.	Blade Width mm	Material of Blade	Note	Range	Sales Pkg Qty	Part No.
TMA075	32x30	TC/HM #50	Blade thickness 2.0mm	★★★	1	B-65084

**Sanding pad for abrasive paper delta Starlock shank**



Makita No.	Blade Width mm	Range	Sales Pkg Qty	Part No.
TMA078	93	★★★	1	B-65115

**TC remover Starlock shank Grout abrasive**



Makita No.	Blade Width mm	Material of Blade	Note	Range	Sales Pkg Qty	Part No.
TMA074	70	TC/HM #40	Blade thickness 3.0mm	★★★	1	B-65078

**Multi tool blade Starlock shank assortment set**

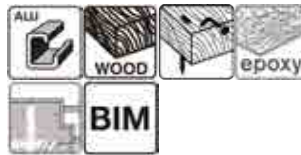

Makita No.	Range	Sales Pkg Qty	Part No.
TMA045, TMA047, TMA053, TMA058	★★★	4	B-67480
TMA045, TMA048, TMA051, TMA066	★★★	4	B-67505
TMA058, TMA065, TMA069, TMA073	★★★	4	B-67496
TMA045, TMA047, TMA053, 2xTMA078	★★★	5	B-67511

**TC sanding plate Starlock shank Grout abrasive Delta shape**

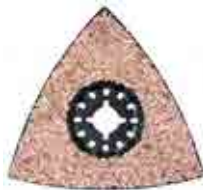

Makita No.	Blade Width mm	Material of Blade	Note	Range	Sales Pkg Qty	Part No.
TMA073	78	TC/HM #20	-	★★★	1	B-65062
TMA083	90	TC/HM #20	-	★★★	1	B-69799
TMA084	90	TC/HM #40	-	★★★	1	B-69808
TMA085	90	TC/HM #60	-	★★★	1	B-69814
TMA086	90	TC/HM #100	Use only wood	★★★	1	B-69820

### Abrasive delta paper (Page 132) applications



Rating Suitability for application

- AA: Recommended
- A: Acceptable
- n.r.: No Rating

Product Application and Rating On Each Material		Grit	Paint	Varnish	Filler	Roughcast	Wood/Wooden materials	softwood	hard wood	Plywood	Chipboard/MDF	Metal	Steel (mild steel / carbon steel)	Stone	Marble	Granite	Glass	Perspex	Corian	Glass fiber reinforced		
Wood / long-life	Coarse	60	n.r.	n.r.	n.r.	n.r.	AA	AA	AA	AA	AA	AA	A	n.r.	n.r.	n.r.	n.r.	n.r.	n.r.	n.r.	n.r.	
		80																				
	Medium	100																				
		120																				
	Fine	180																				
240																						
Wood (★★★)	Coarse	60	n.r.	n.r.	n.r.	n.r.	AA	A	AA	AA	AA	n.r.	n.r.	n.r.	n.r.	n.r.	n.r.	n.r.	n.r.	n.r.	n.r.	n.r.
		80																				
	Medium	100																				
		120																				
	Fine	150																				
180																						
Wood (★★)	Coarse	40	A	A	n.r.	n.r.	AA	AA	AA	AA	A	A	A	n.r.	n.r.	n.r.	n.r.	n.r.	n.r.	n.r.	n.r.	n.r.
		60																				
		80																				
	Medium	100																				
		120																				
Fine	150																					
	180																					
Paint	Coarse	60	AA	AA	AA	AA	n.r.	n.r.	A	n.r.	n.r.	A	A	n.r.	n.r.	n.r.	n.r.	n.r.	n.r.	n.r.	n.r.	n.r.
		80																				
	Medium	100																				
		120																				
	Fine	240																				
320																						
Stone	Medium	120	A	AA	n.r.	n.r.	n.r.	n.r.	n.r.	n.r.	n.r.	n.r.	n.r.	A	A	A	A	A	A	A	A	A
		240																				
	Fine	400																				
		600																				
	Very fine	1200																				



## STARLOCK PLUS

Compatibility with models		STARLOCK	STARLOCK PLUS	STARLOCK MAX
OIS Compatible Tools				
STARLOCK MAX				

### Plunge cut saw blade Starlock plus shank Wood and metal



Makita No.	Blade Width mm	Tpi	Material of Blade	Note	Range	Sales Pkg Qty	Part No.
MAP001	32x60	20TPI	BIM	Bow shape	★★★	1	B-66329
MAP002	65x50	20TPI	BIM	Bow shape	★★★	1	B-66335

### Plunge cut saw blade Starlock plus shank Wood



Makita No.	Blade Width mm	Tpi	Material of Blade	Note	Range	Sales Pkg Qty	Part No.
MAP003	32x60	18TPI	HCS	Bow shape	★★★	1	B-66341

### TC bar plunge cut saw blade Starlock plus shank Metal



Makita No.	Blade Width mm	Tpi	Material of Blade	Range	Sales Pkg Qty	Part No.
MAP004	32x50	23TPI	TC/HM	★★★	1	B-66357
MAP005	45x50	23TPI	TC/HM	★★★	1	B-66363

### TC bar plunge cut saw blade Starlock plus shank Multi material

STARLOCK PLUS

Makita No.	Blade Width mm	Tpi	Material of Blade	Note	Range	Sales Pkg Qty	Part No.
MAP006	32x50	20TPI	TC/HM	Bow shape	★★★	1	B-66379
MAP007	52x50	20TPI	TC/HM	Bow shape	★★★	1	B-66385

### TC plunge and segment blade Starlock plus shank Grout abrasive

STARLOCK PLUS

Makita No.	Blade Width mm	Material of Blade	Range	Sales Pkg Qty	Part No.
MAP008	53x40	TC/HM #40	★★★	1	B-66391

## STARLOCK MAX

Compatibility with models		STARLOCK	STARLOCK PLUS	STARLOCK MAX
OIS Compatible Tools				
STARLOCK MAX				



### Segment saw blade Starlock max shank Wood and metal



Makita No.	Blade Width mm	Tpi	Material of Blade	Range	Sales Pkg Qty	Part No.
MAM003	100x50	15TPI	BIM	★★★	1	B-66422

**Plunge cut saw blade Starlock max shank Wood and metal**

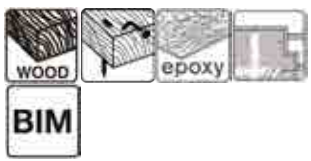
**STARLOCK MAX**

Makita No.	Blade Width mm	Tpi	Material of Blade	Note	Range	Sales Pkg Qty	Part No.
MAM001	32x80	20TPI	BIM	Bow shape	★★★	1	B-66400
MAM002	52x70	18TPI	BIM	Bow shape	★★★	1	B-66416

**Joint cutter blade Starlock max shank Multi material**

**STARLOCK MAX**



Makita No.	Blade Width mm	Material of Blade	Range	Sales Pkg Qty	Part No.
MAM007	32x70	HCS	★★★	1	B-66466
MAM008	32x55	HCS	★★★	1	B-66472

**Plunge cut saw blade Starlock max shank Wood**

**STARLOCK MAX**



Makita No.	Blade Width mm	Tpi	Material of Blade	Note	Range	Sales Pkg Qty	Part No.
MAM004	32x80	18TPI	HCS	Bow shape	★★★	1	B-66438

**TC segment blade Starlock max shank Grout abrasive**

**STARLOCK MAX**



Makita No.	Blade Width mm	Material of Blade	Note	Range	Sales Pkg Qty	Part No.
MAM009	68x10	TC/HM #50	Blade thickness 1.5mm	★★★	1	B-66494
MAM010	68x30	TC/HM #30	Blade thickness 2.2mm	★★★	1	B-66503
MAM013	68x30	TC/HM #40	Blade thickness 2.1mm	★★★	1	B-66531
MAM014	100x50	TC/HM #40	Blade thickness 1.9mm	★★★	1	B-66547

**TC bar plunge cut saw blade Starlock max shank Metal**



**STARLOCK MAX**



Makita No.	Blade Width mm	Tpi	Material of Blade	Range	Sales Pkg Qty	Part No.
MAM005	32x70	23TPI	TC/HM	★★★	1	B-66444

**Diamond segment blade Starlock max shank Grout abrasive**

**STARLOCK MAX**

Makita No.	Blade Width mm	Material of Blade	Note	Range	Sales Pkg Qty	Part No.
MAM012	68x10	Diamond #40	Blade thickness 1.5mm	★★★	1	B-66525
MAM011	68x30	Diamond #40	Blade thickness 2.2mm	★★★	1	B-66519

**TC bar plunge cut saw blade Starlock max shank Multi material**

**STARLOCK MAX**



Makita No.	Blade Width mm	Tpi	Material of Blade	Note	Range	Sales Pkg Qty	Part No.
MAM006	32x70	20TPI	TC/HM	Bow shape	★★★	1	B-66450

**TC sanding plate Starlock max shank Grout abrasive Delta shape**

**STARLOCK MAX**

Makita No.	Blade Width mm	Material of Blade	Note	Range	Sales Pkg Qty	Part No.
MAM015	116	TC/HM #20		★★★	1	B-66553
MAM016	116	TC/HM #40		★★★	1	B-66569
MAM017	116	TC/HM #60	Use only wood	★★★	1	B-66575
MAM018	116	TC/HM #100		★★★	1	B-66581

# ACCESSORIES

## ▣ Diamond



Thread / Dia



Dia / Bore



Max speed



Wet



Dry



Not permitted for face grinding

## Diamond Wheels



### Segmented Type:

Most commonly used. Blade has slits and layers of diamond are sintered on edges. Cut faster than continuous rim type and attain average cutting surface.



### Segmented Wave Type:

This wheel has slits like segmented wheel. Each segment has many notches (Wave). These notches assure;

- Fast cutting with less resistance.
- Smooth debris removal.
- Less loading on wheel.



### Corrugated Type:

This wheel has notches around the Rim. Has a characteristic between Continuous Rim and Segmented Type. Has faster cutting like Segmented Type. At the same time, can attain cleaner surface like continuous rim without broken edges.



### Continuous Rim Type:

Has layer of diamond with uniform thickness around the entire rim. Can attain clean surface even on crusty, brittle materials. Cut with accuracy but not as fast as segmented type wheel.

## SPECIALIZED



### Electrodeposited Type:

Diamonds are electrodeposited and has more exposure than bonded type. Cuts faster and more efficient.



### Vacuum brazed Type:

Diamonds are vacuum brazed and has more exposure than bonded type. Able to cut harder material. It is longer life than electrodeposited type because diamonds are held tightly.



### Crack Chaser:

Blade is thicker than regular blades. Designed for repair the wall easily.

## Material

Material No. 1						
Hard concrete	Granite	Gneiss	Smoothable Engineering	Carbonaceous Shale	Sidewalk Slate	Engineering Block/ Engineering Block Class 2

Material No. 2				Material No. 3		
Concrete	Block	U-shaped Groove	Sidewalk Block	Hard concrete	Cemented Tile	Unglazed Tile

Material No. 4		Material No. 5		Material No. 6	Material No. 7
Brick	Aggregate Block	Asphalt		Tile	Glass

**Diamond Wheel for Concrete**



**X-Lock**

Four-star range

★★★★



<Ideal for Concrete / Dry>

Shape	D	T	X	H	d	Color	For Material							Model No.	Part No.
							1	2	3	4	5	6	7		
	100	1.6	7	-	-	Blue	AA	AA	AA	A				X-LOCK 100mm Grinder	E-02054(EN)
	115	1.6	7	-	-	Blue	AA	AA	AA	A				X-LOCK 115mm Grinder	E-02060(EN)
	125	1.6	7	-	-	Blue	AA	AA	AA	A				X-LOCK 125mm Grinder	E-02076(EN)

**Segmented**

Four-star range

★★★★



<Ideal for Concrete / Dry>

Shape	D	T	X	H	d	Color	For Material							Model No.	Part No.
							1	2	3	4	5	6	7		
	230	2.4	15	22.23	-	Blue	AA	AA	AA	A				230mm DC Power cutter	E-02967(EN)
	355	2.8	10	25.4	-	Blue	AA	AA	AA	A				355mm DC Power cutter, 355mm Engine power cutter	E-12996(EN)



**1. Ideal for cordless tools**

The distance of cutting for 1 Battery charge



Note:  
The test results depend to a great extent on the hardness of materials, etc.  
The numbers in the bar graphs are relative values when the capacity of Makita Diamond Wheel (Thickness:2.2mm) is indexed at 100.

**2. Thin blade & Light weight**



This blade is designed as 1.6mm (the basis is 1.1mm). So smooth and light cutting is available.

It was lightened by punching the body. (eg.ø125mm blade is 95g [current blade : 125g]) It is also reduced the load on the battery and increased the cutting distance per 1 battery charge.

<Ideal for Concrete, Granite / Dry>

	115	1.6	7	22.23	-	Blue	AA	AA	AA	A				115mm Grinder	B-53780(EN)
	125	1.6	7	22.23	-	Blue	AA	AA	AA	A				125mm Grinder	B-53796(EN)

**Three-star range**

★★★

<Ideal for Concrete / Dry>

	105	1.8	7	20	16	Gold		AA	AA	A	A			100mm Grinder, 110mm Cutter	A-88842
	105	1.8	7.5	20	16	Gold		AA	AA	A				100mm Grinder, 110mm Cutter	A-87149
	105	1.7	7	20	5/8"	Blue		AA	AA	A	A			100mm Grinder, 110mm Cutter	A-90211
	110	1.8	6	20	-	Gold		AA	AA	A	A			110mm Cutter	A-05022
	125	2	7	22.23	5/8"	Blue		AA	AA	A	A			5005BA, 125mm Grinder	A-07331
	180	2	6.5	25.4	22	Gold		AA	AA	A				180mm Grinder, 180mm Cutter	A-87155
	230	2.2	7.5	22.23	-	Blue		AA	AA	A	A			230mm Grinder	A-02820
	230	2.2	7.5	22.23	-	Gold		AA	AA	A				230mm Grinder	A-86826

Shape	D	T	X	H	d	Color	For Material							Model No.	Part No.
							1	2	3	4	5	6	7		

Two-star range

★★

&lt;Ideal for Concrete / Dry&gt;

	105	1.8	7	20	16	Gold		AA	AA	A	A			100mm Grinder, 110mm Cutter	A-84187(EN)
	115	1.9	7	22.23	-	Gold		AA	AA	A	A			115mm Grinder	A-84109(EN)
	125	1.9	7	22.23	20	Gold		AA	AA	A	A			125mm Grinder, 125mm Cutter	A-84115(EN)
	150	2.1	7	22.23	-	Gold		AA	AA	A	A			150mm Grinder	B-06432(EN)
	180	2.3	7	25.4	22.2 3	Gold		AA	AA	A	A			180mm Grinder, 180mm Cutter	A-84121(EN)
	230	2.5	7	22.23	-	Gold		AA	AA	A	A			230mm Grinder	A-84137(EN)

&lt;Ideal for Concrete / Dry &gt;

Long life

	105	2	7	20	16	Gold		AA	AA	A	A			100mm Grinder, 110mm Cutter	D-05197
	115	2	7	22.23	-	Gold		AA	AA	A				115mm Grinder	D-37552 D-37552-10
	125	2.2	7	22.23	-	Gold		AA	AA	A				125mm Grinder	D-37568

One-star range

★

&lt;Ideal for Concrete / Dry &gt;

	105	2	7	20	16	Gold	A	AA	A	A				100mm Grinder, 110mm Cutter	D-42531
	115	1.8	7	22.23	-	Gold	A	AA	A	A				115mm Grinder	D-44270
	180	2.2	7	22.23	-	Gold	A	AA	A	A				180mm Grinder	D-44286
	230	2.4	7	22.23	-	Gold	A	AA	A	A				230mm Grinder	D-44292

&lt;Ideal for Concrete / Dry &gt;

	105	2.2	9	20	16	Gold		AA						100mm Grinder, 110mm Cutter	D-71009
	115	2.2	9	22.23	-	Gold		AA						115mm Grinder	D-71015
	125	2.2	9	22.23	20	Gold		AA						125mm Grinder, 125mm Cutter	D-71021

**Corrugated**

Three-star range

★★★

&lt;Ideal for Concrete / Dry &gt;

Shape	D	T	X	H	d	Color	For Material							Model No.	Part No.
							1	2	3	4	5	6	7		
	105	2	10	20	16	Gold	AA	AA	A	A	A			100mm Grinder, 110mm Cutter	B-39207
	115	2	7	22.23	-	Silver		AA	AA	AA	A			115mm Grinder	B-02967
	125	2	7	22.23	20	Silver		AA	AA	AA	A			125mm Grinder, 125mm Cutter	B-02973
	180	2	7	22.23	-	Silver		AA	AA	AA	A			180mm Grinder	B-02989
	230	2.3	7	22.23	-	Silver		AA	AA	AA	A			230mm Grinder	B-01806

&lt;Ideal for Concrete / Dry&gt;

	105	2	7	20	16	Gold		AA	AA	A	A			100mm Grinder, 110mm Cutter	A-84193(EN)
	115	2	7	22.23	-	Gold		AA	AA	A	A			115mm Grinder	A-84143(EN)
	125	2.1	7	22.23	20	Gold		AA	AA	A	A			125mm Grinder, 125mm Cutter	A-84159(EN)
	180	2.3	7	25.4	22.23	Gold		AA	AA	A	A			180mm Grinder, 180mm Cutter	A-84165(EN)
	230	2.6	7	22.23	-	Gold		AA	AA	A	A			230mm Grinder	A-84171(EN)

&lt;Ideal for Concrete / Dry &gt;

Long life

	105	2	7	20	16	Gold		AA	AA	A				100mm Grinder, 110mm Cutter	D-05206
	115	2.3	7	22.23	-	Gold		AA	AA	A				115mm Grinder	D-37596
	125	2.5	7	22.23	-	Gold		AA	AA	A				125mm Grinder	D-37605
	180	2.9	7	22.23	-	Gold		AA	AA	A				180mm Grinder	D-37611
	230	3.1	7	22.23	-	Gold		AA	AA	A				230mm Grinder	D-37627

One-star range

★

&lt;Ideal for Concrete / Dry&gt;

	110	2.2	7	20	16	Gold		AA	AA	A				100mm Grinder, 110mm Cutter	D-42606
	110	2.2	10	20	16	Gold		AA	AA	A				100mm Grinder, 110mm Cutter	D-42640
	110	2	10	20	16	Blue	A	AA	A	A				100mm Grinder, 110mm Cutter	D-42628

## Segmented wave

Three-star range

★★★

<Ideal for Concrete / Dry>

Shape	D	T	X	H	d	Color	For Material							Model No.	Part No.
							1	2	3	4	5	6	7		
	105	1.8	7.5	20	16	Gold	AA	AA	A	A			100mm Grinder, 110mm Cutter	B-03028	
	115	2	7.5	22.23	-	Blue	AA	AA	A	A			115mm Grinder	A-80422	
	125	2	7.5	22.23	-	Blue	AA	AA	A	A			125mm Grinder	A-80438(EN)	
	180	2.2	7	22.23	-	Blue	AA	AA	A	A			180mm Grinder	A-83842	
	230	2.5	7.5	22.23	-	Blue	AA	AA	A				230mm Grinder	A-80173(EN)	

<Concrete & Granite / Dry>

	115	2	7.5	22.23	-	Gold	AA	AA	AA	A	A		115mm Grinder	B-02048
	125	2	7.5	22.23	-	Gold	AA	AA	AA	A	A		125mm Grinder	B-02054
	180	2.2	8	22.23	-	Gold	AA	AA	AA	A	A		180mm Grinder	B-02060
	230	2.5	7.5	22.23	-	Gold	AA	AA	AA	A	A		230mm Grinder	B-02004

One-star range

★

<Ideal for Concrete, Granite/ Dry>

	105	2.2	7	20	16	Blue	AA	AA	A	A			100mm Grinder, 110mm Cutter	D-42581
	115	2	7	22.23	-	Blue	AA	AA	A	A			115mm Grinder	D-41420
	180	2.6	7	22.23	-	Blue	AA	AA	A	A			180mm Grinder	D-44339
	230	2.8	7	22.23	-	Blue	AA	AA	A	A			230mm Grinder	D-44345

## Continuous rim

Three-star range

★★★

<Ideal for Concrete & Brick / Dry >

Shape	D	T	X	H	d	Color	For Material							Model No.	Part No.
							1	2	3	4	5	6	7		
	80	1.6	3.5	20	-	Gold	AA	AA	AA	AA		AA	4103KB	792192-6	
	80	1.6	3.5	20	-	Gold	AA	AA	AA	AA		AA	4103KB	B-22012(EN)	

<Ideal for Concrete & Brick / Wet>

	110	1.6	5	20	-	Gold		AA	AA	A		A	110mm Cutter	D-05212
	110	1.5	4	20	-	Gold	A	AA	AA	A	A	AA	110mm Cutter	A-07185
	125	1.5	4	20	-	Silver	A	AA	A	AA		A	125mm Cutter	A-87292
	125	1.9	5.5	20	-	Silver	A	AA	A	AA		A	125mm Cutter	B-21951(EN)
	180	1.85	4	25	-	Gold	A	AA	AA	A	A	AA	180mm Cutter	A-80117

<Wet>

	110	1.5	4	20	-	Blue	AA	AA	AA	AA		AA	110mm Cutter	A-01292
	180	1.85	4	25	-	Gold	AA	AA	AA	AA	A	AA	180mm Cutter	792191-8

### Diamond Wheel for Stone



#### Segmented

Three-star range



<Ideal for Granite / Dry>

Shape	D	T	X	H	d	Color	For Material							Model No.	Part No.
							1	2	3	4	5	6	7		
	125	2	7.5	20	-	Gold	AA	AA	AA	AA	A			4105KB	792282-5
	125	1.9	7	22.23	20	Blue	AA	AA	AA	AA				125mm Grinder, 125mm Cutter	A-01236
	255	2.5	7	25.4	-	Blue	AA	AA	AA	AA	A			255mm Cutter	A-02406

Two-star range



<Ideal for Granite / Dry>

	105	1.8	7	20	16	Silver	AA	AA	A	A			100mm Grinder, 110mm Cutter	D-42656
	105	1.7	7	20	16	Silver	AA	AA	AA	A	A		100mm Grinder, 110mm Cutter	A-84090
	115	1.8	7	22.23	-	Silver	AA	AA	AA	A	A		115mm Grinder	A-84006
	125	2	7	22.23	20	Silver	AA	AA	AA	A	A		125mm Grinder, 125mm Cutter	A-84012
	180	2	6	25.4	22.23	Silver	AA	AA	AA	A	A		180mm Grinder, 180mm Cutter	A-84028
	230	2.2	6.5	22.23	-	Silver	AA	AA	AA	A	A		230mm Grinder	A-84408

One-star range



<Wet>

\*D-63688<Dry/Wet>

	105	1.8	10	20	16	Silver	AA	A	A	A			110mm Cutter	D-44351
	105	1.8	10	20	16	Green	A	A	AA	A			110mm Cutter	D-44367
	105	2	8	20	16	Silver	AA	A	AA	A			100mm Grinder, 110mm Cutter	D-63688

#### Corrugated

Three-star range



<Ideal for Granite / Dry>

Shape	D	T	X	H	d	Color	For Material							Model No.	Part No.
							1	2	3	4	5	6	7		
	125	2	7	22.23	20	Blue	AA	AA	AA	A	A			125mm Grinder, 125mm Cutter	A-02761

<Ideal for Granite / Dry>

	115	2	7	22.23	-	Blue	AA	AA	AA	A	A			115mm Grinder	A-80684(EN)
	125	2	7	22.23	-	Blue	AA	AA	AA	A	A			125mm Grinder	A-80690(EN)
	180	2	7	22.23	A	Blue	AA	AA	AA	A	A			180mm Grinder	A-80709
	230	2.3	7	22.23	-	Blue	AA	AA	AA	A	A			230mm Grinder	A-80715(EN)

<Wet>

	110	1.6	5	20	-	Gold	AA	AA	AA	A	A	AA		110mm Cutter	B-02836
	110	2	5	20	-	Gold	AA	AA	AA	A	A	AA		110mm Cutter	B-22034(EN)
	125	2.6	7	20	-	White	AA	AA	A	A	A	A		125mm Cutter	B-16748(EN)

Two-star range



<Curved Corrugated / Dry>

	110	2.5	7	20	-	Gold		A	AA	A				110mm Cutter	D-36968
--	-----	-----	---	----	---	------	--	---	----	---	--	--	--	--------------	---------



Shape	D	T	X	H	d	Color	For Material							Model No.	Part No.
							1	2	3	4	5	6	7		
<Ideal for Granite / Dry>															
	105	2	7	20	16	Silver	AA	AA	AA	A	A			100mm Grinder, 110mm Cutter	A-84040(EN)
	110	2	7	20	16	Silver	AA	AA	AA	A	A			100mm Grinder, 110mm Cutter	D-42662
	115	2	7	22.23	-	Silver	AA	AA	AA	A	A			115mm Grinder	A-84056(EN)
	125	2.1	7	22.23	20	Silver	AA	AA	AA	A	A			125mm Grinder, 125mm Cutter	A-84062(EN)
	180	2.3	7	25.4	22.23	Silver	AA	AA	AA	A	A			180mm Grinder, 180mm Cutter	A-84078(EN)
	230	2.6	7	22.23	-	Silver	AA	AA	AA	A	A			230mm Grinder	A-84084(EN)

One-star range



<Ideal for Granite, Marble / Dry>

	105	2.2	7	20	16	Silver	AA	A	AA	A			100mm Grinder, 110mm Cutter	D-42553
	115	2	7	22.23	-	Silver	AA	A	AA	A			115mm Grinder	D-44301
	180	2.6	7	22.23	-	Silver	AA	A	AA	A			180mm Grinder	D-44317
	230	3	7	22.23	-	Silver	AA	A	AA	A			230mm Grinder	D-44323

**Continuous rim**

Three-star range



<Ideal for Hard material / Dry>

Shape	D	T	X	H	d	Color	For Material							Model No.	Part No.
							1	2	3	4	5	6	7		
	80	1.4	5	20	-	Blue	AA	AA	AA	AA		AA		4103KB	A-01264

**Diamond Wheel for Tile**



**Corrugated**

Four-star range



1. Ideal for cordless tools

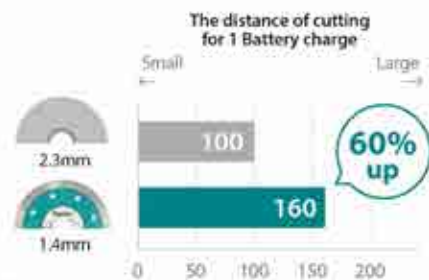

Note:  
The test results depend to a great extent on the hardness of materials, etc.  
The numbers in the bar graphs are relative values when the capacity of Makita Diamond Wheel (Thickness:2.3mm) is indexed at 100.

2. Thinner blade

With the bare necessities of thickness which able to have enough strength, able to get smooth and light cutting.

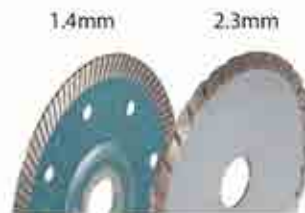

Ideal for Porcelain Tile / Dry  
Thin type

Shape	D	T	X	H	d	Color	For Material							Model No.	Part No.
							1	2	3	4	5	6	7		
	105	1.4	10	22.23	16	Blue		A	A	AA		AA		100mm Grinder	B-49030(EN)
	115	1.4	10	22.23		Blue		A	A	AA		AA		115mm Grinder	B-46327(EN)
	125	1.4	10	22.23	-	Blue		A	A	AA		AA		125mm Grinder	B-46333(EN)

Three-star range



<Ideal for Porcelain Tile / Dry>

Thin type

	110	1.3	8	20	16	Violet		A	A	A		AA		110mm Cutter	D-51057
	115	1.3	8	22.23		Violet		A	A	A		AA		115mm Grinder	D-50893
	180	1.6	8	22.23	-	Violet		A	A	A		AA		180mm Grinder	D-50902

**Continuous rim**

Three-star range

★★★

<Wet>

Shape	D	T	X	H	d	Color	For Material							Model No.	Part No.
							1	2	3	4	5	6	7		
	110	1.5	4	20	-	Silver	AA	AA	AA				AA	110mm Cutter	A-85210
	110	1.5	4	20	-	Gold	A	AA	AA	A	A	AA		110mm Cutter	A-81131

<Ideal for Marmoglass / Wet>

	110	1.7	8	20	-	Violet							AA	110mm Cutter, 4100NH2	D-37770
---	-----	-----	---	----	---	--------	--	--	--	--	--	--	----	-----------------------	---------

Two-star range

★★

<Dry>

	115	1.4	10	22.23	-	Violet							AA	115mm Grinder	D-65109
---	-----	-----	----	-------	---	--------	--	--	--	--	--	--	----	---------------	---------

One-star range

★

<Ideal for ceramic tile / Wet>

	110	1.8	5	20	16	Violet		AA	A	A		AA		110mm Cutter	D-44258
	180	2.2	5	25.4	-	Violet		AA	A	A		AA		180mm Cutter	D-44264

**Diamond Wheel for Glass**



**Corrugated**

Three-star range

★★★

<Ideal for Bulletproof Glass / Wet>

Shape	D	T	X	H	d	Color	For Material							Model No.	Part No.
							1	2	3	4	5	6	7		
	110	1.2	6	20	-	Blue			AA	A	A	AA	AA	110mm Cutter	B-00795
	110	1.9	6	20	-	Blue			AA	A	A	AA	AA	110mm Cutter	B-22028(EN)

**Continuous rim**

Three-star range

★★★

<Ideal for Bulletproof Glass / Wet>

Shape	D	T	X	H	d	Color	For Material							Model No.	Part No.
							1	2	3	4	5	6	7		
	110	1.2	5	20	-	Violet							AA	110mm Cutter, 4100NH2	D-40705

### Specialized / Electroplated Diamond Wheel

for Marble



#### Fine Surface

Cutting surface is very fine for the additional diamond on the plate's side.



#### DRY Cutting and Smoothly Cutting

Thanks to high-quality diamond, it can be used for dry cutting despite rim type. So smooth and fine cutting of marble is available.

< Comparison of cutting surface >

#### Electroplated type



#### Normal



\*D-45004 :Wet

Shape	D	T	X	H	d	Color	For Material							Model No.	Part No.	
							1	2	3	4	5	6	7			
	110	2	4.5	20	-	Green			AA						110mm Cutter	D-45004(EN)
	115	2	5	22.23	-	Green			AA						115mm Grinder	D-51085(EN)
	180	2.2	5	22.23	-	Green			AA						180mm Grinder	D-51091(EN)
	230	2.4	5	22.23	-	Green			AA						230mm Grinder	D-51100(EN)

### Specialized / Vacuum brazed Diamond Wheel



#### 1. Cut various material

Steel      Stainless      Nonferrous metal      PVC      Concrete



The diamond abrasive grain are adhered on wheel surface directly which is different from the regular wheel containing diamond abrasive grain buried on layers .

#### 2. Less spark

Diamond wheel

Abrasive Cut-off wheel



The major general contractor dislike sparks at the work site, so you can recommend this blade to these work site.

Multi cut

Shape	D	T	X	H	d	Color	For Material							Model No.	Part No.	
							1	2	3	4	5	6	7			
	110	2	5.0	20	16	Violet	A	A	A	A					100mm Grinder, 110mm Cutter	D-44426
	230	3.2	5.0	22,23	-	Gold	A	A	A	A	A	A	A	230mm Grinder	A-89894	
	305	3.3	8.0	20	-	Gold	A	A	A	A	A	A	A	305mm Power Cutter	A-88808	
	100	2.8	4.0	16	-	Red	A	A	A	A	A	A	A	100mm Grinder	B-66933(EN)	
	115	2.8	4.0	22.23	-	Red	A	A	A	A	A	A	A	115mm Grinder	B-55304(EN)	
	125	2.8	4.0	22.23	-	Red	A	A	A	A	A	A	A	125mm Grinder	B-55310(EN)	
	180	3.1		22.23		Red	A	A	A	A	A	A	A	180mm Grinder	B-66949(EN)	
	230	3.1	4.0	22.23	-	Red	A	A	A	A	A	A	A	230mm Grinder	B-55326(EN)	
	300	3.4	4.0	25.4	20	Red	A	A	A	A	A	A	A	305mm Power Cutter	B-55332(EN)	
	350	3.4	4.0	25.4	20	Red	A	A	A	A	A	A	A	355mm Power Cutter	B-55348(EN)	
405	3.6		25.4		Red	A	A	A	A	A	A	A	405mm Power Cutter	B-66955(EN)		

for Metal



Shape	D	T	X	H	d	Color	For Material							Model No.	Part No.
							1	2	3	4	5	6	7		
	100	1.3	1.5	16	-	Violet	-	-	-	-	-	-	-	100mm Grinder	B-53671(EN)
	115	1.3	1.5	22.23	-	Violet	-	-	-	-	-	-	-	115mm Grinder	B-53687(EN)
	125	1.3	1.5	22.23	-	Violet	-	-	-	-	-	-	-	125mm Grinder	B-53693(EN)
	180	1.3	1.5	22.23	-	Violet	-	-	-	-	-	-	-	180mm Grinder	B-53702(EN)
	230	1.3	1.5	22.23	-	Violet	-	-	-	-	-	-	-	230mm Grinder	B-53718(EN)

**Specialized / Tungsten Carbide Grit Blade**



Application	D	T	X	H	d	Color	For Material							Model No.	Part No.
							1	2	3	4	5	6	7		
PVC, Plaster board, Sanding board, Fiber material	115	2	-	22.23	-	Blue	-	-	-	-	-	-	-	115mm Grinder	B-57716
PVC, Plaster board, Sanding board, Fiber material	125	2	-	22.23	-	Blue	-	-	-	-	-	-	-	125mm Grinder	B-57722

**Specialized / for Mortar raking**

For Joints



zD	T	X	H	d	Color	For Material							Model No.	Part No.	
						1	2	3	4	5	6	7			
125	4.5	8	22.23	-	Silver									125mm Grinder	A-02705(EN)

**Specialized / Crack Chaser**  
**Crack Chaser**

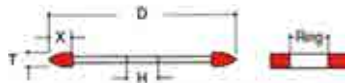

D	T	X	H	d	Color	For Material							Model No.	Part No.	
						1	2	3	4	5	6	7			
105	9.5	12.5	22.23	16	Gold		AA	AA	A	A				100mmGrinder	D-16427
125	9.5	12.5	22.23	-	Gold		AA	AA	A	A				125mmGrinder	D-16477

**Specialized / Cordless Cutter**



Application	D	T	X	H	d	Color	For Material							Model No.	Part No.
							1	2	3	4	5	6	7		
High Grade / Continuous rim / Wet	80	0.8	4	15	-	Silver						AA	AA	4190DW, 4191DW	792296-4
Standard / Continuous rim / Glass / Wet	85	0.9	4	15	-	Silver						AA	AA	CC300D	B-21082
	85	1.8	5	15	-	Silver						AA	AA	CC300D	B-21098(EN)
Standard / Corrugated / Glass / Dry	85	0.9	5	15	-	Gold			AA	A	A	AA	AA	CC300D, 4190DW, 4191DW	B-02995
Standard / Corrugated / Universal / Dry & Wet	85	1.1	5	15	-	Blue		AA	AA	A	A	AA	AA	CC300D, 4190DW, 4191DW	A-07353
Standard / Electrodeposited / Glass & Porcelain / Wet	85	0.8	2.2	15	-	Silver			AA			AA	AA	CC300D, 4190DW, 4191DW	A-07179
	85	0.8	2.2	15	-	Silver			AA			AA	AA	CC300D, 4190DW, 4191DW	A-07163

## Specialized / Engine Power Cutter Tools

Laser Welded



Application	D	T	X	H	d	Color	For Material							Model No.	Part No.	
							1	2	3	4	5	6	7			
High Grade / Segmented / Hard Concrete	300	2.8	7	25.4	20	Gold	AA	AA	AA	AA	A				305mm Power Cutter	A-87018
Standard / Segmented / General	300	2.8	5	25.4	20	Silver	A	AA	AA	AA					305mm Power Cutter	A-86773
Standard / Segmented / Concrete, Brick	304	2.8	6.5	25.4	20	Silver	A	AA	AA	AA					305mm Power Cutter	A-89349
Standard / Segmented / General	350	3.2	5	25.4	20	Silver	A	AA	AA	AA					355mm Power Cutter	A-87317

## Specialized / 305mm Cutter, Engine Power Cutter Tools



Application	D	T	X	H	d	Color	For Material							Model No.	Part No.	
							1	2	3	4	5	6	7			
Standard / Segmented / Concrete / Dry	305	3	7.5	30	20, 22.23, 25.4	Gold		AA	AA	A	A				305mm Cutter, Power Cutter	A-02478
Standard / Segmented / Asphalt / Dry	305	3	7.5	30		Silver					A				305mm Cutter, Power Cutter	A-02484
Standard / Segmented / Concrete & Asphalt / Dry	305	3	7.5	30		Blue		AA	AA	AA	A				305mm Cutter, Power Cutter	A-02490

## Specialized / 355mm Portable Cut-off Tools



Application	D	T	X	H	d	Color	For Material							Model No.	Part No.	
							1	2	3	4	5	6	7			
Vacuum brazed / Metal	355	3.3	4	25.4	-	Violet									355mm Portable Cut-off	D-41414
Vacuum brazed / Metal / Speed type	355	3.3	4	25.4	-	Violet									355mm Portable Cut-off	B-29511

## Specialized / Wall Chaser Tools



Application	D	T	X	H	d	Color	For Material							Model No.	Part No.	
							1	2	3	4	5	6	7			
Segmented / Dry	125	2	7.5	22.23	-	Blue		AA	AA	A	A				SG1251	A-80438(EN)
Segmented / Dry	155	2	7	22.23	-	Blue		AA	AA	A	A				SG150	A-83836

# Accessories

## Offset Diamond Wheels



### Rough work

This wheel grind more efficiency. Faster than the wheel for standard work.



### Standard work

This wheel has a characteristic between Rough work offset diamond wheels and Fine work offset diamond wheels.

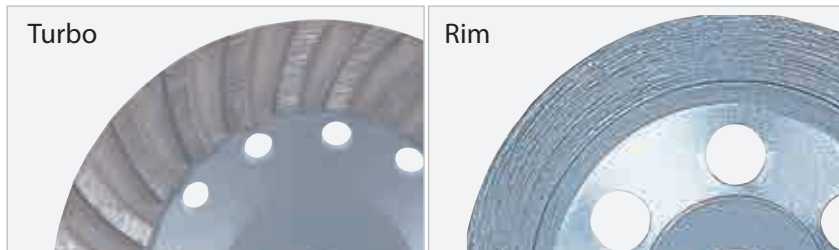

### Fine work

This wheel is suitable for cleanup and finish work and chamfering works.

## SPECIALIZED



### Removal of paint

This wheel is suitable for removal of polyurethane, adhesive, paint, epoxy and acrylic coating. PCD is an abbreviations of "Polycrystalline Diamond". It is a kind of an artificial diamond and superior in hardness and durability.



### For hard materials

This wheel is suitable for hard materials. Diamonds are held tightly.

## Low Vibration Offset Diamond Wheel



### Low Vibration

The vibration is not conducted to the worker's hand and able to ease the load a lot!!

### Less Tapping

Clinging to the material and able to cut smoothly, faster and more efficient.

### Low Vibration Type

Normal



Low Vibration Type

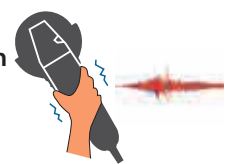

### Low Vibration Offset Diamond Wheel



Four-star range



AA: Specially suitable, A: Suitable  
(EN) : EN13236

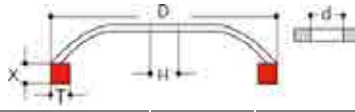

D	T	X	H	d	For Material					For Model	Part No.
					1	2	3	4	5		

#### Rough work

Single type



125	8	5.5	M14	-	AA	AA	AA	A	A	125mm Grinder	B-48533(EN)
180	8	5	M14	-	AA	AA	AA	A	A	180mm Grinder	B-48599(EN)

#### Standard work

Double type

- Stable work



125	8	5.5	M14	-	AA	AA	AA	A	A	125mm Grinder	B-48549(EN)
180	8	5	M14	-	AA	AA	AA	A	A	180mm Grinder	B-48608(EN)

Segmated type

- More clean surface finish



125	8	5.5	M14	-	AA	AA	AA	A	A	125mm Grinder	B-38560(EN)
-----	---	-----	-----	---	----	----	----	---	---	---------------	-------------

Fan type

- Good dust removal, and high efficiency



125	7	5.5	M14	-	AA	AA	AA	A	A	125mm Grinder	B-48555(EN)
180	7	5	M14	-	AA	AA	AA	A	A	180mm Grinder	B-48614(EN)

#### Fine work

Turbo type

- Good dust removal, and high efficiency
- Stable work and easy to grind the corners



125	15	4.5	M14	-	AA	AA	AA	A	A	125mm Grinder	B-49993(EN)
180	20	5	M14	-	AA	AA	AA	A	A	180mm Grinder	B-48620(EN)

### Offset Diamond Wheel

AA: Specially suitable, A: Suitable  
(EN) : EN13236

D	T	X	H	d	For Material					For Model	Part No.
					1	2	3	4	5		

#### Rough work

Single type

Three-star range



105	8	4	22.23	-	A	AA	A	A	A	115mm Grinder	B-14629
125	8	5.5	22.23	-	AA	AA	AA	A	A	PC5000, 5001C 125mm Grinder	B-48561(EN)
180	8	5	22.23	-	AA	AA	AA	A	A	180mm Grinder	B-48636(EN)

One-star range



100	8	5	22.23	16	A	AA	A	A	A	100mm Grinder	D-62284
115	8	5	22.23	-	A	AA	A	A	A	115mm Grinder	D-60676
125	8	5	22.23	-	A	AA	A	A	A	PC5000, 5001C 125mm Grinder	D-60682
180	8	5	22.23	-	A	AA	A	A	A	180mm Grinder	D-62290

#### Standard work

Double type

- Stable work

Three-star range



D	T	X	H	d	For Material					For Model	Part No.
					1	2	3	4	5		
125	8	5	22.23	-	AA	AA	AA	A	A	PC5000, 5001C 125mm Grinder	B-12295(EN)
125	8	5.5	22.23	-	AA	AA	AA	A	A	PC5000, 5001C 125mm Grinder	B-48577(EN)
180	8	5	22.23	-	AA	AA	AA	A	A	180mm Grinder	B-48642(EN)

Two-star range



125	7	5	22.23	-	AA	AA	AA	A	A	PC5000, 5001C	D-41458(EN)
-----	---	---	-------	---	----	----	----	---	---	---------------	-------------

One-star range



100	8	5	22.23	16	AA	AA	AA	A	A	100mm Grinder	D-62309
115	8	5	22.23	-	AA	AA	AA	A	A	115mm Grinder	D-62315
125	8	5	22.23	-	AA	AA	AA	A	A	125mm Grinder	D-66715
180	8	5	22.23	-	AA	AA	AA	A	A	180mm Grinder	D-62321

Segmated type

- More clean surface finish

Three-star range



D	T	X	H	d	For Material					For Model	Part No.
					1	2	3	4	5		
100	8	5	22.23	16	AA	AA	AA	A	A	100mm Grinder	A-87105
110	8	5	15	-	AA	AA	AA	A	A	PC1100	A-86321(EN)

D	T	X	H	d	For Material					For Model	Part No.
					1	2	3	4	5		

Fan type

- Good dust removal, and high efficiency

Three-star range



125	7	5.5	22.23	-	AA	AA	AA	A	A	PC5000, 5001C 125mm Grinder	B-48583(EN)
180	7	5	22.23	-	AA	AA	AA	A	A	180mm Grinder	B-48658(EN)

**Fine work**

Turbo type

- Good dust removal, and high efficiency
- Stable work and easy to grind the corners

Three-star range



D	T	X	H	d	For Material					For Model	Part No.
					1	2	3	4	5		
105	10	5	22.23	-	A	AA	A	A	A	115mm Grinder	B-44993
110	13.5	4	15	-	AA	AA	AA	A	A	PC1100	A-07369(EN)
125	15	4.5	22.23	-	AA	AA	AA	A	A	PC5000, 5001C 125mm Grinder	B-50005(EN)
180	20	5	22.23	-	AA	AA	AA	A	A	180mm Grinder	B-48664(EN)

One-star range



100	8	5	22.23	16	AA	AA	AA	A	A	100mm Grinder	D-62337
115	8	5	22.23	-	AA	AA	AA	A	A	115mm Grinder	D-62343
125	20	5	22.23	-	AA	AA	AA	A	A	125mm Grinder	D-66721
180	8	5	22.23	-	AA	AA	AA	A	A	180mm Grinder	D-62359

Rim type

- More clean surface finish
- Stable work and easy to grind the corners

Three-star range



110	13.5	4	15	-	AA	AA	AA	A	A	PC1100	792289-1(EN)
125	13.5	4	22.23	-	AA	AA	AA	A	A	PC5000, 5001C 125mm Grinder	B-12289(EN)

One-star range



125	13	5	22.23	-	AA	AA	AA	A	A	PC5000, 5001C	D-41464(EN)
-----	----	---	-------	---	----	----	----	---	---	---------------	-------------

### Specialized/ PCD Offset Diamond Wheel

This Offset Diamond Wheel can be used for removing of polyurethane, adhesive, paint, epoxy and acrylic coatings.



< Difference with the normal offset diamond >



If just scratch the surface and couldn't remove the paint film.

Specialized

D	T	X	H	d	For Material					For Model	Part No.
					1	2	3	4	5		
125	-	-	22.23	-	-	-	-	-	-	PC5000, 5001C 125mm Grinder	B-53160
180	-	-	22.23	-	-	-	-	-	-	PC5000, 5001C 180mm Grinder	B-53176

### Vacuum brazed Offset Diamond Wheel

Standard work

Three-star range



D	T	X	H	d	For Material					For Model	Part No.
					1	2	3	4	5		

Angle type



115	27.5	-	22.23	-	AA	A	A			115mm Grinder	A-87834(EN)
-----	------	---	-------	---	----	---	---	--	--	---------------	-------------

Flat type



115	27.5	-	22.23	-	AA	A	A			115mm Grinder	A-87884(EN)
-----	------	---	-------	---	----	---	---	--	--	---------------	-------------

### SDS-Plus Diamond core bit (Dry type)

When drilling with diamond core bit, always use "rotation only".  
SDS-Plus adapter (with center bit) A-87563



For Model:  
SDS-PLUS hammers, Spindle thread M18

Capacity (Diameter x Depth)	Part No.
38 x 175mm	A-87535
54 x 175mm	A-87541
65 x 175mm	A-87557

### Diamond core bit (Dry Type)

When drilling with diamond core bit, always use "rotation only".  
Center bit (A-80503), Center bit shank (A-80519)

For Model:  
8406, 8406C



Spindle thread M18, 13mm straight shank (three flat)

Capacity (Diameter x Depth)	Part No.	Capacity (Diameter x Depth)	Part No.
32 x 165mm	A-85036	90 x 165mm	A-85086
38 x 165mm	A-85042	105 x 165mm	A-80488
54 x 165mm	A-85058	120 x 165mm	A-80494
65 x 165mm	A-85064	127 x 165mm	A-85606
70 x 165mm	A-85070	152 x 165mm	A-85597
80 x 165mm	A-80472	162 x 165mm	A-85612

Diamond Core Drill Bit for Grinders		
	Vacuum blazed	Electroplated
<b>Fix</b>	Special chemical bond	Nickel plating
<b>Fixing strength of diamond</b>	High	Low
<b>Cutting material</b>	Marble, Granite, Porcelain Tile	Marble
<b>Precision of cutting</b>	Middle	High

### Electroplated diamond core bit



For: 115mm, 125mm, 150mm, 180mm, 230mm Angle Grinder  
Material : Marble

Size	Spindle thread	Part No.
25mm	M14 x 2	D-35025
30mm	M14 x 2	D-35019
35mm	M14 x 2	D-35003
40mm	M14 x 2	D-37007
45mm	M14 x 2	D-37013

### Vacuum Brazed diamond core bit



For: 115mm, 125mm, 150mm, 180mm, 230mm Angle Grinder  
Material : Granite/Marble/Porcelain Tile

Size	Spindle thread	Part No.
5 mm	M14 x 2	D-61064
6mm	M14 x 2	D-61070
8mm	M14 x 2	D-61086
10mm	M14 x 2	D-61092
12mm	M14 x 2	D-61101
14mm	M14 x 2	D-44432
16mm	M14 x 2	D-44448
20mm	M14 x 2	D-44454
22mm	M14 x 2	D-44460
25mm	M14 x 2	D-44476
27mm	M14 x 2	D-44482
30mm	M14 x 2	D-44498
32mm	M14 x 2	D-44507
35mm	M14 x 2	D-44513
38mm	M14 x 2	D-44529
40mm	M14 x 2	D-44535
45mm	M14 x 2	D-44541
51mm	M14 x 2	D-44557
55mm	M14 x 2	D-44563
57mm	M14 x 2	D-44579
60mm	M14 x 2	D-44585
65mm	M14 x 2	D-44591
67mm	M14 x 2	D-44600
68mm	M14 x 2	D-44616
70mm	M14 x 2	D-44622
75mm	M14 x 2	D-44638
80mm	M14 x 2	D-44644
83mm	M14 x 2	D-44650

Spindle thread M10

For: 100mm Angle Grinder

Size	Spindle thread	Part No.
5mm	M10 x 1.5	D-75063
6mm	M10 x 1.5	D-75079
8mm	M10 x 1.5	D-75085
10mm	M10 x 1.5	D-75091
12mm	M10 x 1.5	D-75100
14mm	M10 x 1.5	D-75116
16mm	M10 x 1.5	D-75122
19mm	M10 x 1.5	D-75138
20mm	M10 x 1.5	D-75144
25mm	M10 x 1.5	D-75150
26mm	M10 x 1.5	D-75166
32mm	M10 x 1.5	D-75172
37mm	M10 x 1.5	D-75188
40mm	M10 x 1.5	D-75194
50mm	M10 x 1.5	D-75203

### Vacuum Brazed diamond pin drill



For: 13mm Driver Drill  
Material : Granite/Marble/Porcelain Tile

Size	Spindle thread	Part No.
6mm	6mm x 12.5mm	B-51823
8mm	8mm x 12.5mm	B-51839
10mm	10mm x 12.5mm	B-51845

# ACCESSORIES

## ▣ Planing / Routering



**Mini planer blade/ HSS**



Size mm	Range	Sales Pkg Qty	Part No.
50	★★★	2	A-85400
155	★★★	2	B-02864
306	★★★	2	793346-8
312	★★★	2	B-02870

**Mini planer blade/ TC**



Size mm	Note	Range	Sales Pkg Qty	Part No.
82	-	★★★	2	A-82921
82	-	★★	2	D-07945
82	With plates	★★	2	D-07951
82	-	★★	10	D-35302
82	-	★	2	D-70823
82	-	★	10	D-70839



**Planer blade/ HSS**



Size mm	Range	Sales Pkg Qty	Part No.
80	★★	2	D-65501
82	★★	2	D-16346
82	★	2	D-67228
82	★	10	D-67234
110	★★	2	D-71211
136	★★	2	D-71227
155	★★	2	D-63915
155	★★	2	D-70910
170	★★	2	D-63666
400	★★★	2	793019-3

**Planer blade/ TC**



Size mm	Range	Sales Pkg Qty	Part No.
82	★★	2	D-07967
82	★	2	D-72207
110	★★	2	D-08822
155	★★★	2	793015-1
306	★★★	2	793137-7

**Drywall guide bit**

For Model: 3706, DCO180, DCO181



Size mm (inch)	Type	Range	Sales Pkg Qty	Part No.
3.0	-	★★★	1	193450-7
(1/8)	-	★★★	1	191G69-8
(1/8)	-	★★★	5	191G68-0
(1/4)	-	★★★	1	193447-6
(1/4)	Diamond bit	★★★	1	A-87915

**Straight bit 1flute**



Shank dia. mm (inch)	Overall dia. mm (inch)	Length mm (inch)	Carbide Height mm (inch)	Range	Sales Pkg Qty	Part No.
6	6	50	18	★★★	1	D-09167
6	6	51	19	★★	1	D-47416
6	6	51	19	★★	1	D-67701
8	3	51	13	★★	1	D-47379
8	3	51	13	★★	1	D-67664
8	4	48	13	★★	1	D-67670
8	4	51	13	★★	1	D-47385
8	5	48	13	★★	1	D-47391
8	5	48	13	★★	1	D-67686
8	6	51	19	★★	1	D-47400
8	6	51	19	★★	1	D-67692
(1/4)	(1/8)	(2)	(1/2)	★★	1	D-49002
(1/4)	(1/8)	(2)	(1/2)	★★	1	D-68862
(1/4)	(5/32)	(2)	(1/2)	★★	1	D-49018
(1/4)	(5/32)	(2)	(1/2)	★★	1	D-68878
(1/4)	(3/16)	(1-7/8)	(1/2)	★★	1	D-49024
(1/4)	(3/16)	(1-7/8)	(1/2)	★★	1	D-68884
(1/4)	(15/64)	(2-1/32)	(23/32)	★★★	1	D-09173
(1/4)	(1/4)	(2)	(3/4)	★★	1	D-49030
(1/4)	(1/4)	(2)	(3/4)	★★	1	D-68890
(1/2)	(1/4)	(2-1/2)	(3/4)	★★	1	D-62739
(1/2)	(1/4)	(2-1/2)	(3/4)	★★	1	D-68909
(1/2)	(3/8)	(2-1/2)	(1)	★★	1	D-62745
(1/2)	(3/8)	(2-1/2)	(1)	★★	1	D-68915

**Straight bit 2flute**



Shank dia. mm (inch)	Overall dia. mm (inch)	Length mm (inch)	Carbide Height mm (inch)	Range	Sales Pkg Qty	Part No.
6	6	48	16	★★	1	D-47422
6	6	48	16	★★	1	D-67717
6	6	57	25	★★	1	D-47438
6	6	57	25	★★	1	D-67723
6	8	51	19	★★	1	D-47444
6	8	51	19	★★	1	D-67739
6	8	52	20	★★★	1	D-09260
6	8	57	25.4	★★	1	D-47450
6	8	57	25.4	★★	1	D-67745
6	10	57	25.4	★★	1	D-47466
6	10	57	25.4	★★	1	D-67751
6	12	64	32	★★	1	D-47472
6	12	64	32	★★	1	D-67767
6	14	51	19	★★	1	D-47488
6	14	51	19	★★	1	D-67773
6	20	51	19	★★	1	D-47494
6	20	51	19	★★	1	D-67789
6	20	52	20	★★★	1	D-09313
8	6	48	16	★★	1	D-47503
8	6	48	16	★★	1	D-67795
8	6	51	19	★★	1	D-47519
8	6	51	19	★★	1	D-67804
8	8	51	19	★★	1	D-47525
8	8	51	19	★★	1	D-67810
8	10	51	19	★★	1	D-47531
8	10	51	19	★★	1	D-67826
8	12	51	19	★★	1	D-47547
8	12	51	19	★★	1	D-67832
8	14	51	19	★★	1	D-47553
8	14	51	19	★★	1	D-67848
8	16	51	19	★★	1	D-47569

Shank dia. mm (inch)	Overall dia. mm (inch)	Length mm (inch)	Carbide Height mm (inch)	Range	Sales Pkg Qty	Part No.
8	16	51	19	★★	1	D-67854
8	18	51	19	★★	1	D-47575
8	18	51	19	★★	1	D-67860
8	20	51	19	★★	1	D-47581
8	20	51	19	★★	1	D-67876
8	22	57	25.4	★★	1	D-47597
8	22	57	25.4	★★	1	D-67882
8	24	57	25.4	★★	1	D-47606
8	24	57	25.4	★★	1	D-67898
12	8	70	25	★★	1	D-47612
12	8	70	25	★★	1	D-67907
12	10	38	30	★★★	1	D-10182
12	10	70	25.4	★★	1	D-47628
12	10	70	25.4	★★	1	D-67913
12	12	61	30	★★★	1	D-07892
12	12	73	32	★★	1	D-47634
12	12	73	32	★★	1	D-67929
12	14	73	32	★★	1	D-47640
12	14	73	32	★★	1	D-67935
12	16	73	32	★★	1	D-47656
12	16	73	32	★★	1	D-67941
12	19	73	32	★★	1	D-47662
12	19	73	32	★★	1	D-67957
12	22	73	32	★★	1	D-47678
12	22	73	32	★★	1	D-67963
12	25	73	32	★★	1	D-47684
12	25	73	32	★★	1	D-67979
(1/4)	(1/4)	(1-7/8)	(5/8)	★★	1	D-49096
(1/4)	(1/4)	(1-7/8)	(5/8)	★★	1	D-68965
(1/4)	(1/4)	(2)	(3/4)	★★	1	D-49105
(1/4)	(1/4)	(2)	(3/4)	★★	1	D-68971
(1/4)	(1/4)	(2-1/4)	(1)	★★	1	D-49052
(1/4)	(1/4)	(2-1/4)	(1)	★★	1	D-68921
(1/4)	(5/16)	(2)	(3/4)	★★	1	D-49111
(1/4)	(5/16)	(2)	(3/4)	★★	1	D-68987
(1/4)	(5/16)	(2-1/64)	3/4	★★★	1	D-15388
(1/4)	(5/16)	(2-1/4)	(1)	★★	1	D-49068
(1/4)	(5/16)	(2-1/4)	(1)	★★	1	D-68937
(1/4)	(3/8)	(2)	(3/4)	★★	1	D-49127
(1/4)	(3/8)	(2)	(3/4)	★★	1	D-68993
(1/4)	(3/8)	(2-1/4)	(1)	★★	1	D-49074
(1/4)	(3/8)	(2-1/4)	(1)	★★	1	D-68943
(1/4)	(1/2)	(2)	(3/4)	★★	1	D-49133
(1/4)	(1/2)	(2)	(3/4)	★★	1	D-69004
(1/4)	(1/2)	(2-1/2)	(1-1/4)	★★	1	D-49080
(1/4)	(1/2)	(2-1/2)	(1-1/4)	★★	1	D-68959
(1/4)	(9/16)	(2)	(3/4)	★★	1	D-49149
(1/4)	(9/16)	(2)	(3/4)	★★	1	D-69010
(1/4)	(5/8)	(2)	(3/4)	★★	1	D-49155
(1/4)	(5/8)	(2)	(3/4)	★★	1	D-69026
(1/4)	(23/32)	(2)	(3/4)	★★	1	D-49161
(1/4)	(23/32)	(2)	(3/4)	★★	1	D-69032
(1/4)	(3/4)	(2)	(3/4)	★★	1	D-49177
(1/4)	(3/4)	(2)	(3/4)	★★	1	D-69048
(1/4)	(3/4)	(2-1/64)	(3/4)	★★★	1	D-15431
(1/2)	(1/4)	(2-1/2)	(3/4)	★★	1	D-62751
(1/2)	(1/4)	(2-1/2)	(3/4)	★★	1	D-69054
(1/2)	(5/16)	(2-1/64)	(1)	★★★	1	D-15512
(1/2)	(5/16)	(2-3/4)	(1)	★★	1	D-49183
(1/2)	(5/16)	(2-3/4)	(1)	★★	1	D-69060
(1/2)	(3/8)	(2-7/8)	(1)	★★	1	D-49199
(1/2)	(3/8)	(2-7/8)	(1)	★★	1	D-69076
(1/2)	(15/32)	(2-13/32)	(1-3/16)	★★★	1	D-07901
(1/2)	(1/2)	(2-5/8)	(1)	★★	1	D-62767
(1/2)	(1/2)	(2-5/8)	(1)	★★	1	D-69082
(1/2)	(1/2)	(2-7/8)	(1-1/4)	★★	1	D-49208
(1/2)	(1/2)	(2-7/8)	(1-1/4)	★★	1	D-69098
(1/2)	(1/2)	(3)	(1-1/2)	★★	1	D-62773
(1/2)	(1/2)	(3)	(1-1/2)	★★	1	D-69107
(1/2)	(1/2)	(4)	(2)	★★	1	D-62810
(1/2)	(1/2)	(4)	(2)	★★	1	D-69200
(1/2)	(1/2)	(4-1/2)	(2-1/2)	★★	1	D-58512
(1/2)	(1/2)	(4-1/2)	(2-1/2)	★★	1	D-69191
(1/2)	(9/16)	(2-7/8)	(1-1/4)	★★	1	D-49214
(1/2)	(9/16)	(2-7/8)	(1-1/4)	★★	1	D-69113
(1/2)	(5/8)	(2-7/8)	(1-1/4)	★★	1	D-49220
(1/2)	(5/8)	(2-7/8)	(1-1/4)	★★	1	D-69129
(1/2)	(3/4)	(2-5/8)	(1)	★★	1	D-62789
(1/2)	(3/4)	(2-5/8)	(1)	★★	1	D-69135

Shank dia. mm (inch)	Overall dia. mm (inch)	Length mm (inch)	Carbide Height mm (inch)	Range	Sales Pkg Qty	Part No.
(1/2)	(3/4)	(2-7/8)	(1-1/4)	★★	1	D-49236
(1/2)	(3/4)	(2-7/8)	(1-1/4)	★★	1	D-69141
(1/2)	(3/4)	(3)	(1-1/2)	★★	1	D-62795
(1/2)	(3/4)	(3)	(1-1/2)	★★	1	D-69157
(1/2)	(7/8)	(2-5/8)	(1)	★★	1	D-62804
(1/2)	(7/8)	(2-5/8)	(1)	★★	1	D-69163
(1/2)	(7/8)	(2-7/8)	(1-1/4)	★★	1	D-49242
(1/2)	(7/8)	(2-7/8)	(1-1/4)	★★	1	D-69179
(1/2)	(1)	(2-7/8)	(1-1/4)	★★	1	D-49258
(1/2)	(1)	(2-7/8)	(1-1/4)	★★	1	D-69185

**Straight bit 2flute with top bearing**



Shank dia. (inch)	Overall dia. (inch)	Length (inch)	Carbide Height (inch)	Range	Sales Pkg Qty	Part No.
(1/4)	(1/2)	(1-7/8)	(1/4)	★★	1	D-58497
(1/4)	(1/2)	(1-7/8)	(1/4)	★★	1	D-69353
(1/4)	(1/2)	(2-5/8)	(1)	★★	1	D-58506
(1/4)	(1/2)	(2-5/8)	(1)	★★	1	D-69369
(1/2)	(3/4)	(2-13/16)	(1)	★★	1	D-62826
(1/2)	(3/4)	(2-13/16)	(1)	★★	1	D-69216

**Flush trim bit 2flute**



Shank dia. mm (inch)	Overall dia. mm (inch)	Length mm (inch)	Carbide Height mm (inch)	Range	Sales Pkg Qty	Part No.
6	9.5	58	25.4	★★★	1	D-09472
6	9.5	67	26	★★	1	D-47690
6	9.5	67	26	★★	1	D-67985
6	12.7	56	13	★★	1	D-47709
6	12.7	56	13	★★	1	D-67991
6	12.7	69	26	★★	1	D-47715
6	12.7	69	26	★★	1	D-68002
8	9.5	67	26	★★	1	D-47721
8	9.5	67	26	★★	1	D-68018
8	12.7	56	13	★★	1	D-47737
8	12.7	56	13	★★	1	D-68024
8	12.7	69	26	★★	1	D-47743
8	12.7	69	26	★★	1	D-68030
(1/4)	(1/4)	(2-1/8)	(1/2)	★★	1	D-58528
(1/4)	(1/4)	(2-1/8)	(1/2)	★★	1	D-69266
(1/4)	(3/8)	(2-1/8)	(1/2)	★★	1	D-58534
(1/4)	(3/8)	(2-1/8)	(1/2)	★★	1	D-69272
(1/4)	(3/8)	(2-29/64)	(1)	★★★	1	D-04313
(1/4)	(3/8)	(2-5/8)	(1)	★★	1	D-49264
(1/4)	(3/8)	(2-5/8)	(1)	★★	1	D-69238
(1/4)	(1/2)	(2-3/16)	(1/2)	★★	1	D-49270
(1/4)	(1/2)	(2-3/16)	(1/2)	★★	1	D-69244
(1/4)	(1/2)	(2-11/16)	(1)	★★	1	D-49286
(1/4)	(1/2)	(2-11/16)	(1)	★★	1	D-69250
(1/2)	(1/2)	(3)	(1)	★★	1	D-58540
(1/2)	(1/2)	(3)	(1)	★★	1	D-69288
(1/2)	(1/2)	(3-19/32)	(1-1/2)	★★	1	D-62832
(1/2)	(1/2)	(3-19/32)	(1-1/2)	★★	1	D-69294
(1/2)	(1/2)	(4-1/64)	(2)	★★	1	D-62848
(1/2)	(1/2)	(4-1/64)	(2)	★★	1	D-69303
(1/2)	(3/4)	(3)	(1)	★★	1	D-62854
(1/2)	(3/4)	(3-9/32)	(1)	★★	1	D-69319
(1/2)	(3/4)	(3-5/16)	(1-1/4)	★★	1	D-62860
(1/2)	(3/4)	(3-5/16)	(1-1/4)	★★	1	D-69325

**Flush trim bit 3flute**



Shank dia. mm (inch)	Overall dia. mm (inch)	Length mm (inch)	Carbide Height mm (inch)	Range	Sales Pkg Qty	Part No.
8	12.7	69	26	★★	1	D-47759
8	12.7	69	26	★★	1	D-68046
12	12.7	90	38	★★	1	D-47765
12	12.7	90	38	★★	1	D-68052
(1/4)	(1/2)	(2-11/16)	(1)	★★	1	D-49292
(1/4)	(1/2)	(2-11/16)	(1)	★★	1	D-69331
(1/2)	(1/2)	(3-19/32)	(1-1/2)	★★	1	D-49301
(1/2)	(1/2)	(3-19/32)	(1-1/2)	★★	1	D-69347

**Panel pilot bit**



Shank dia. mm (inch)	Overall dia. mm (inch)	Length mm (inch)	Carbide Height mm (inch)	Range	Sales Pkg Qty	Part No.
6	6	65	19	★★★	1	D-09335
6	6.35	65	19	★★	1	D-47771
6	6.35	65	19	★★	1	D-68068
8	6.35	65	19	★★	1	D-47787
8	6.35	65	19	★★	1	D-68074
8	8	32	19	★★★	1	D-10578
12	9.5	75	26	★★	1	D-47793
12	9.5	76	26	★★	1	D-68080
12	12	38	25.4	★★★	1	D-10584
(1/4)	(1/4)	(2-9/16)	(3/4)	★★	1	D-49317
(1/4)	(1/4)	(2-9/16)	(3/4)	★★	1	D-69375
(1/2)	(3/8)	(3)	(1)	★★	1	D-49323
(1/2)	(3/8)	(3)	(1)	★★	1	D-69381
(1/2)	(1/2)	(3-9/16)	(1-1/8)	★★	1	D-63133
(1/2)	(1/2)	(3-5/8)	(1-17/64)	★★	1	D-58556

**Sash router bit**



Shank dia. mm (inch)	Overall dia. mm (inch)	Length mm (inch)	Carbide Height mm (inch)	Range	Sales Pkg Qty	Part No.
6	6	65	18	★★★	1	D-16988
(1/4)	(15/64)	(2-9/64)	45/64	★★★	1	D-16972

**Hinge mortising bit**



Shank dia. mm (inch)	Overall dia. mm (inch)	Length mm (inch)	Carbide Height mm (inch)	Range	Sales Pkg Qty	Part No.
(1/4)	(1/2)	(2)	(3/4)	★★	1	D-69222
(1/4)	(1/2)	(2-1/64)	(1-17/64)	★★	1	D-58562
(1/2)	(1/2)	(2-3/8)	(3/4)	★★	1	D-63149

**Core box bit**



Shank dia. mm (inch)	Overall dia. mm (inch)	Length mm (inch)	Carbide Height mm (inch)	Radius1 (R)	Range	Sales Pkg Qty	Part No.
8	6.35	38	6.35	3.2	★★	1	D-47977
8	6.35	38	6.35	3.2	★★	1	D-68264
8	7.9	40	8	4	★★	1	D-47983
8	7.9	40	8	4	★★	1	D-68270
8	9.5	41	9.5	4.8	★★	1	D-47999
8	9.5	41	9.5	4.8	★★	1	D-68286
8	12.7	41	10	6.35	★★	1	D-48000
8	12.7	41	10	6.35	★★	1	D-68292
8	15.8	45	12.7	7.9	★★	1	D-48016
8	15.8	45	12.7	7.9	★★	1	D-68301
12	15.8	54	12.7	7.9	★★	1	D-48022
12	15.8	54	12.7	7.9	★★	1	D-68317
12	19	51	12.7	9.5	★★	1	D-48038
12	25.4	57	16	12.7	★★	1	D-48044
(1/4)	(1/4)	(1-1/2)	(1/4)	(1/8)	★★	1	D-49448
(1/4)	(1/4)	(1-1/2)	(1/4)	(1/8)	★★	1	D-69543
(1/4)	(5/16)	(1-37/64)	(5/16)	(5/32)	★★	1	D-49454
(1/4)	(5/16)	(1-37/64)	(5/16)	(5/32)	★★	1	D-69559
(1/4)	(3/8)	(1-5/8)	(3/8)	(3/16)	★★	1	D-49460
(1/4)	(3/8)	(1-5/8)	(3/8)	(3/16)	★★	1	D-69565
(1/4)	(1/2)	(1-5/8)	(3/8)	(1/4)	★★	1	D-49476
(1/4)	(1/2)	(1-5/8)	(3/8)	(1/4)	★★	1	D-69571
(1/4)	(5/8)	(1-3/4)	(1/2)	(5/16)	★★	1	D-49482
(1/4)	(5/8)	(1-3/4)	(1/2)	(5/16)	★★	1	D-69587
(1/2)	(1/4)	(2)	(1/4)	(1/8)	★★	1	D-62929
(1/2)	(5/16)	(2)	(5/16)	(5/32)	★★	1	D-62935
(1/2)	(3/8)	(2)	(3/8)	(3/16)	★★	1	D-62941
(1/2)	(1/2)	(2)	(3/8)	(1/4)	★★	1	D-62957
(1/2)	(5/8)	(2-1/8)	(1/2)	(5/16)	★★	1	D-49498
(1/2)	(3/4)	(2)	(1/2)	(3/8)	★★	1	D-49507
(1/2)	(3/4)	(2)	(1/2)	(3/8)	★★	1	D-69593
(1/2)	(1)	(2-1/4)	(5/8)	(1/2)	★★	1	D-49513
(1/2)	(1)	(2-1/4)	(5/8)	(1/2)	★★	1	D-69602
(1/2)	(1)	(2-9/32)	(11/16)	(1/2)	★★	1	D-62963
(1/2)	(1-1/4)	(2-3/8)	(3/4)	(5/8)	★★	1	D-62979
(1/2)	(1-1/4)	(2-3/8)	(3/4)	(5/8)	★★	1	D-69618
(1/2)	(1-1/2)	(2-7/8)	(7/8)	(3/4)	★★	1	D-62985

**Round nose bit**



Shank dia. mm (inch)	Overall dia. mm (inch)	Length mm (inch)	Carbide Height mm (inch)	Radius1 (R)	Range	Sales Pkg Qty	Part No.
6	6	48	13	3	★★★	1	D-09329
6	6.35	44	12.7	3.2	★★	1	D-47802
6	6.35	44	12.7	3.2	★★	1	D-68096
6	9.5	44	12.7	4.8	★★	1	D-47818
6	9.5	44	12.7	4.8	★★	1	D-68105
6	12.7	51	19	6.35	★★	1	D-47824
6	12.7	51	19	6.35	★★	1	D-68111
8	6.35	44	12.7	3.2	★★	1	D-47830
8	6.35	44	12.7	3.2	★★	1	D-68127
8	9.5	44	12.7	4.8	★★	1	D-47846
8	9.5	44	12.7	4.8	★★	1	D-68133
8	12.7	51	19	6.35	★★	1	D-47852
8	12.7	51	19	6.35	★★	1	D-68149
(1/4)	(1/4)	(1-3/4)	(1/2)	(1/8)	★★	1	D-49345
(1/4)	(1/4)	(1-3/4)	(1/2)	(1/8)	★★	1	D-69406
(1/4)	(3/8)	(1-3/4)	(1/2)	(3/16)	★★	1	D-49351
(1/4)	(3/8)	(1-3/4)	(1/2)	(3/16)	★★	1	D-69412
(1/4)	(1/2)	(2)	(3/4)	(1/4)	★★	1	D-49339
(1/4)	(1/2)	(2)	(3/4)	(1/4)	★★	1	D-69397

Shank dia. mm (inch)	Overall dia. mm (inch)	Length mm (inch)	Carbide Height mm (inch)	Radius1 (R)	Range	Sales Pkg Qty	Part No.
(1/2)	(3/8)	(2-1/4)	(1/2)	(3/16)	★★	1	D-62876
(1/2)	(3/8)	(2-1/4)	(1/2)	(3/16)	★★	1	D-69428
(1/2)	(1/2)	(2-3/8)	(3/4)	(1/4)	★★	1	D-62882
(1/2)	(1/2)	(2-3/8)	(3/4)	(1/4)	★★	1	D-69434
(1/2)	(3/4)	(2-5/8)	(1)	(3/8)	★★	1	D-62898
(1/2)	(3/4)	(2-5/8)	(1)	(3/8)	★★	1	D-69440

**Ball groove bit**



Shank dia. mm (inch)	Overall dia. mm (inch)	Length mm (inch)	Carbide Height mm (inch)	Radius1 (R)	Range	Sales Pkg Qty	Part No.
8	9.5	41	8.3	4.8	★★	1	D-48119
8	12.7	44	11.4	6.4	★★	1	D-48125
8	15.9	48	14.8	7.9	★★	1	D-48131
8	19	51	18.2	9.5	★★	1	D-48147
(1/4)	(3/8)	(1-5/8)	(21/64)	(3/16)	★★	1	D-49585
(1/4)	(1/2)	(1-3/4)	(29/64)	(1/4)	★★	1	D-49591
(1/4)	(1/2)	(1-3/4)	(29/64)	(1/4)	★★	1	D-69668
(1/4)	(5/8)	(1-7/8)	(37/64)	(5/16)	★★	1	D-49600
(1/4)	(3/4)	(2)	(23/32)	(3/8)	★★	1	D-49616

**V groove bit**



Shank dia. mm (inch)	Overall dia. mm (inch)	Length mm (inch)	Carbide Height mm (inch)	Angle (°)	Range	Sales Pkg Qty	Part No.
6	12.7	45	12.7	90	★★	1	D-47868
6	12.7	45	12.7	90	★★	1	D-68155
6	12.7	48	16	60	★★	1	D-47874
6	12.7	48	16	60	★★	1	D-68161
6	19	48	16	90	★★	1	D-47880
6	19	48	16	90	★★	1	D-68177
6	19	53	20	60	★★★	1	D-09391
6	20	47	15	30	★★★	1	D-09379
8	12.7	45	12.7	90	★★	1	D-47896
8	12.7	45	12.7	90	★★	1	D-68183
8	12.7	48	16	60	★★	1	D-47961
8	12.7	48	16	60	★★	1	D-68258
8	15.9	44	12.7	90	★★	1	D-47905
8	15.9	44	12.7	90	★★	1	D-68199
8	19	48	16	90	★★	1	D-47933
8	19	48	16	90	★★	1	D-68220
12	12.7	54	12.7	90	★★	1	D-47911
12	12.7	54	12.7	90	★★	1	D-68208
12	15.9	51	12.7	90	★★	1	D-47927
12	15.9	51	12.7	90	★★	1	D-68214
12	19	57	16	90	★★	1	D-47949
12	19	57	16	90	★★	1	D-68236
12	28.6	60	22.2	90	★★	1	D-47955
12	28.6	60	22.2	90	★★	1	D-68242
(1/4)	(1/2)	(1-3/4)	(1/2)	90	★★	1	D-49389
(1/4)	(1/2)	(1-3/4)	(1/2)	90	★★	1	D-69478
(1/4)	(1/2)	(1-7/8)	(5/8)	60	★★	1	D-49367
(1/4)	(1/2)	(1-7/8)	(5/8)	60	★★	1	D-69456
(1/4)	(5/8)	(1-3/4)	(1/2)	90	★★	1	D-49395
(1/4)	(5/8)	(1-3/4)	(1/2)	90	★★	1	D-69484
(1/4)	(45/64)	(1-7/8)	(5/8)	90	★★★	1	D-15453
(1/4)	(3/4)	(1-7/8)	(5/8)	90	★★	1	D-49373
(1/4)	(3/4)	(1-7/8)	(5/8)	90	★★	1	D-69462
(1/2)	(1/2)	(2-1/8)	(1/2)	90	★★	1	D-49404
(1/2)	(1/2)	(2-1/8)	(1/2)	90	★★	1	D-69490
(1/2)	(5/8)	(2)	(1/2)	90	★★	1	D-49410

Shank dia. mm (inch)	Overall dia. mm (inch)	Length mm (inch)	Carbide Height mm (inch)	Angle (°)	Range	Sales Pkg Qty	Part No.
(1/2)	(5/8)	(2)	(1/2)	90	★★	1	D-69509
(1/2)	(3/4)	(2-1/4)	(5/8)	90	★★	1	D-49426
(1/2)	(3/4)	(2-1/4)	(5/8)	90	★★	1	D-69521
(1/2)	(7/8)	(2-1/4)	(5/8)	90	★★	1	D-62907
(1/2)	(7/8)	(2-1/4)	(5/8)	90	★★	1	D-69515
(1/2)	(1)	(2-3/8)	(3/4)	90	★★	1	D-62913
(1/2)	(1-1/8)	(2-3/8)	(7/8)	90	★★	1	D-49432
(1/2)	(1-1/8)	(2-3/8)	(7/8)	90	★★	1	D-69537

**Point cut roundover bit**



Shank dia. (inch)	Overall dia. (inch)	Length (inch)	Carbide Height (inch)	Radius1 (R)	Range	Sales Pkg Qty	Part No.
(1/2)	(3/8)	(2-1/4)	(3/8)	(3/16)	★★	1	D-63177

**Keyhole bit**



Shank dia. mm (inch)	Overall dia. mm (inch)	Length mm (inch)	Carbide Height mm (inch)	Range	Sales Pkg Qty	Part No.
8	9.5	48	10.5	★★	1	D-48907
8	9.5	48	10.5	★★	1	D-68812
(1/4)	(3/8)	(1-7/8)	(13/32)	★★	1	D-50217
(1/4)	(3/8)	(1-7/8)	(13/32)	★★	1	D-70063

**Slatwall bit**



Shank dia. mm (inch)	Overall dia. mm (inch)	Length mm (inch)	Carbide Height mm (inch)	Range	Sales Pkg Qty	Part No.
12	38	55.5	17.5	★★★	1	D-61852
(1/2)	38	55.5	17.5	★★★	1	D-61868

**Ovolo bit**



Shank dia. mm (inch)	Overall dia. mm (inch)	Length mm (inch)	Carbide Height mm (inch)	Radius1 (R)	Range	Sales Pkg Qty	Part No.
6	16	41	9	4	★★★	1	D-09357
6	19	43	9.5	3.2	★★	1	D-48278
6	19	43	9.5	3.2	★★	1	D-68373
6	25	45	13	8	★★★	1	D-09363
6	25.4	45	13.5	6.35	★★	1	D-48284
6	25.4	45	13.5	6.35	★★	1	D-68389
(1/4)	(3/4)	(1-11/16)	(3/8)	(1/8)	★★	1	D-49747
(1/4)	(3/4)	(1-11/16)	(3/8)	(1/8)	★★	1	D-69733
(1/4)	(1)	(1-13/16)	(17/32)	(1/4)	★★	1	D-49753
(1/2)	(3/4)	(1-7/8)	(3/8)	(1/8)	★★	1	D-63024
(1/2)	(1)	(2-7/64)	(17/32)	(1/4)	★★	1	D-63030

**Roundover bit**



Shank dia. mm (inch)	Overall dia. mm (inch)	Length mm (inch)	Carbide Height mm (inch)	Radius1 (R)	Range	Sales Pkg Qty	Part No.
6	19	42	9.5	3	★★★	1	D-09422
6	19	53	9.5	3.2	★★	1	D-48290
6	19	53	9.5	3.2	★★	1	D-68395
6	20.6	52	10	4	★★	1	D-48309
6	20.6	52	10	4	★★	1	D-68404
6	25	45	13	6	★★★	1	D-09444
6	25.4	56	13.5	6.35	★★	1	D-48315
6	25.4	56	13.5	6.35	★★	1	D-68410
6	28.6	57	14.5	7.9	★★	1	D-48321
6	28.6	57	14.5	7.9	★★	1	D-68426
6	31.8	60	16.7	9.5	★★	1	D-48337
6	31.8	60	16.7	9.5	★★	1	D-68432
8	17.3	51	8	2.3	★★	1	D-48343
8	17.3	51	8	2.3	★★	1	D-68448
8	19	53	9.5	3.2	★★	1	D-48359
8	19	53	9.5	3.2	★★	1	D-68454
8	20.7	52	10	4	★★	1	D-48365
8	20.7	52	10	4	★★	1	D-68460
8	22.2	55	12.7	4.8	★★	1	D-48371
8	22.2	55	12.7	4.8	★★	1	D-68476
8	25.4	56	13.5	6.35	★★	1	D-48387
8	25.4	56	13.5	6.35	★★	1	D-68482
8	28.6	57	14.5	7.9	★★	1	D-48393
8	28.6	57	14.5	7.9	★★	1	D-68498
8	31.8	60	16.7	9.5	★★	1	D-48402
8	31.8	60	16.7	9.5	★★	1	D-68507
8	38.1	62	19	12.7	★★	1	D-48418
8	38.1	62	19	12.7	★★	1	D-68513
12	50.8	76	25.4	19	★★	1	D-48424
12	50.8	76	25.4	19	★★	1	D-68529
(1/4)	(3/4)	(2-1/8)	(3/8)	(1/8)	★★	1	D-49769
(1/4)	(3/4)	(2-1/8)	(3/8)	(1/8)	★★	1	D-69749
(1/4)	(7/8)	(2-5/32)	(1/2)	(3/16)	★★	1	D-69755
(1/4)	(7/8)	(2-5/32)	(1/2)	(3/16)	★★	1	D-49775
(1/4)	(7/8)	(2-3/16)	(1/2)	(3/16)	★★★	1	D-15475
(1/4)	(1)	(2-1/4)	(17/32)	(1/4)	★★	1	D-49781
(1/4)	(1)	(2-1/4)	(17/32)	(1/4)	★★	1	D-69761
(1/4)	(1-1/8)	(2-1/4)	(9/16)	(5/16)	★★	1	D-49797
(1/4)	(1-1/8)	(2-1/4)	(9/16)	(5/16)	★★	1	D-69777
(1/4)	(1-1/4)	(2-5/16)	(21/32)	(3/8)	★★	1	D-49806
(1/4)	(1-1/4)	(2-5/16)	(21/32)	(3/8)	★★	1	D-69783
(1/4)	(1-1/2)	(2-7/16)	(3/4)	(1/2)	★★	1	D-49812
(1/4)	(1-1/2)	(2-7/16)	(3/4)	(1/2)	★★	1	D-69799
(1/2)	(5/8)	(2-5/32)	(15/32)	(1/16)	★★	1	D-63046
(1/2)	(3/4)	(2-5/16)	(3/8)	(1/8)	★★	1	D-63052
(1/2)	(1-1/4)	(2-11/16)	(21/32)	(3/8)	★★	1	D-63068
(1/2)	(1-1/2)	(2-11/16)	(3/4)	(1/2)	★★	1	D-63074
(1/2)	(1-1/2)	(2-11/16)	(3/4)	(1/2)	★★	1	D-69808
(1/2)	(2)	(2-15/16)	(1)	(3/4)	★★	1	D-49828
(1/2)	(2)	(2-15/16)	(1)	(3/4)	★★	1	D-69814

**Double roundover bit**



Shank dia. mm (inch)	Overall dia. mm (inch)	Length mm (inch)	Carbide Height mm (inch)	Radius1 (R)	Range	Sales Pkg Qty	Part No.
8	28.6	51	12.7	4	★★	1	D-48577
8	28.6	51	12.7	4	★★	1	D-68650
(1/4)	(1-1/8)	(2)	(1/2)	(5/32)	★★	1	D-49909
(1/4)	(1-1/8)	(2)	(1/2)	(5/32)	★★	1	D-69870

**Beading bit**



Shank dia. mm (inch)	Overall dia. mm (inch)	Length mm (inch)	Carbide Height mm (inch)	Radius1 (R)	Range	Sales Pkg Qty	Part No.
6	17	49	8	2.3	★★	1	D-48430
6	17	49	8	2.3	★★	1	D-68535
6	19	52	9.5	3.2	★★	1	D-48446
6	19	52	9.5	3.2	★★	1	D-68541
6	20.3	51	10	4	★★	1	D-48452
6	20.3	51	10	4	★★	1	D-68557
6	21	42	9.5	4	★★★	1	D-09525
6	22.2	53	12.7	4.8	★★	1	D-48468
6	22.2	53	12.7	4.8	★★	1	D-68563
6	28	45	13	8	★★★	1	D-09547
6	28.6	56	14.5	7.9	★★	1	D-48474
6	28.6	56	14.5	7.9	★★	1	D-68579
8	17.3	49	8	2.3	★★	1	D-48480
8	17.3	49	8	2.3	★★	1	D-68585
8	19	52	9.5	3.2	★★	1	D-48496
8	19	52	9.5	3.2	★★	1	D-68591
8	20.7	51	10	4	★★	1	D-48505
8	22.2	53	13	4.8	★★	1	D-48511
8	25.4	55	13.5	6.35	★★	1	D-48527
8	25.4	55	13.5	6.35	★★	1	D-68600
8	28.6	56	14.5	7.9	★★	1	D-48533
8	28.6	56	14.5	7.9	★★	1	D-68616
8	31.8	58	17	9.5	★★	1	D-48549
8	31.8	58	17	9.5	★★	1	D-68622
8	38.1	60	19	12.7	★★	1	D-48555
8	38.1	60	19	12.7	★★	1	D-68638
12	50.8	75	25.4	19	★★	1	D-48561
12	50.8	75	25.4	19	★★	1	D-68644
(1/4)	(3/4)	(2-1/32)	(3/8)	(1/8)	★★	1	D-49834
(1/4)	(3/4)	(2-1/32)	(3/8)	(1/8)	★★	1	D-69820
(1/4)	(7/8)	(2-1/8)	(1/2)	(3/16)	★★	1	D-49840
(1/4)	(7/8)	(2-1/8)	(1/2)	(3/16)	★★	1	D-69836
(1/4)	(1)	(2-5/32)	(17/32)	(1/4)	★★	1	D-49856
(1/4)	(1)	(2-5/32)	(17/32)	(1/4)	★★	1	D-69842
(1/4)	(1-1/8)	(2-3/16)	(9/16)	(5/16)	★★	1	D-49862
(1/4)	(1-1/4)	(2-9/32)	(21/32)	(3/8)	★★	1	D-49878
(1/4)	(1-1/4)	(2-9/32)	(21/32)	(3/8)	★★	1	D-69858
(1/4)	(1-1/2)	(2-3/8)	(3/4)	(1/2)	★★	1	D-49884
(1/4)	(1-1/2)	(2-3/8)	(3/4)	(1/2)	★★	1	D-69864
(1/2)	(2)	(2-61/64)	(1)	(3/4)	★★	1	D-49890

**Plunge cut roundover bit**



Shank dia. mm (inch)	Overall dia. mm (inch)	Length mm (inch)	Carbide Height mm (inch)	Radius1 (R)	Range	Sales Pkg Qty	Part No.
8	19	45	12.7	6.35	★★	1	D-48153
8	19	45	12.7	6.35	★★	1	D-68367
8	25.4	48	16	9.5	★★	1	D-48169
8	38.1	60	28.6	12.7	★★	1	D-48175
(1/4)	(3/4)	(1-3/4)	(1/2)	(1/4)	★★	1	D-49622
(1/4)	(3/4)	(1-7/8)	(1/2)	(1/4)	★★	1	D-69674
(1/4)	(1)	(1-7/8)	(5/8)	(3/8)	★★	1	D-49638
(1/4)	(1)	(1-7/8)	(5/8)	(3/8)	★★	1	D-69680
(1/4)	(1-1/2)	(2-3/8)	(1-1/8)	(1/2)	★★	1	D-49644

**Cove bit**



Shank dia. mm (inch)	Overall dia. mm (inch)	Length mm (inch)	Carbide Height mm (inch)	Radius1 (R)	Range	Sales Pkg Qty	Part No.
6	20	40	8	4	★★★	1	D-09400
6	25	45	13	8	★★★	1	D-09416
8	15.9	49	6.35	1.6	★★	1	D-48583
8	17.5	49	6.35	2.4	★★	1	D-48599
8	19	46	9.7	3.2	★★	1	D-48608
8	22.2	56	12.7	4.8	★★	1	D-48614
8	22.2	56	12.7	4.8	★★	1	D-68666
8	28.6	56	12.7	7.9	★★	1	D-48620
8	28.6	56	12.7	7.9	★★	1	D-68672
8	31.8	56	14	9.5	★★	1	D-48636
8	31.8	56	14	9.5	★★	1	D-68688
8	38.1	58	15.4	12.7	★★	1	D-48642
(1/4)	(5/8)	(1-15/16)	(1/4)	(1/16)	★★	1	D-49915
(1/4)	(5/8)	(1-15/16)	(1/4)	(1/16)	★★	1	D-69886
(1/4)	(11/16)	(1-15/16)	(1/4)	(3/32)	★★	1	D-49921
(1/4)	(3/4)	(1-13/16)	(3/8)	(1/8)	★★	1	D-49937
(1/4)	(3/4)	(1-13/16)	(3/8)	(1/8)	★★	1	D-69892
(1/4)	(7/8)	(2-3/16)	(1/2)	(3/16)	★★	1	D-49943
(1/4)	(7/8)	(2-3/16)	(1/2)	(3/16)	★★	1	D-69901
(1/4)	(1-1/8)	(2-3/16)	(1/2)	(5/16)	★★	1	D-49959
(1/4)	(1-1/8)	(2-3/16)	(1/2)	(5/16)	★★	1	D-69917
(1/4)	(1-1/4)	(2-13/64)	(17/32)	(3/8)	★★	1	D-49965
(1/4)	(1-1/4)	(2-13/64)	(17/32)	(3/8)	★★	1	D-69923
(1/4)	(1-1/2)	(2-5/16)	(5/8)	(1/2)	★★	1	D-49971
(1/4)	(1-1/2)	(2-5/16)	(5/8)	(1/2)	★★	1	D-69939
(1/2)	(1-1/4)	(2-17/32)	(17/32)	(3/8)	★★	1	D-63080
(1/2)	(1-1/2)	(2-9/16)	(5/8)	(1/2)	★★	1	D-63096
(1/2)	(1-3/4)	(2-11/16)	(3/4)	(5/8)	★★	1	D-63105
(1/2)	(2)	(2-7/8)	(7/8)	(3/4)	★★	1	D-63111

**Cove with fillet bit**



Shank dia. mm (inch)	Overall dia. mm (inch)	Length mm (inch)	Carbide Height mm (inch)	Radius1 (R)	Range	Sales Pkg Qty	Part No.
6	22	42	10	3	★★★	1	D-09553
6	25.4	54	12.7	4.8	★★	1	D-48795
6	25.4	54	12.7	4.8	★★	1	D-68806
(1/4)	(1)	(2-3/16)	(1/2)	(3/16)	★★	1	D-50120
(1/2)	(1-1/4)	(2-7/16)	(19/32)	(5/16)	★★	1	D-63127

**Chamfer bit**



Shank dia. mm (inch)	Overall dia. mm (inch)	Length mm (inch)	Carbide Height mm (inch)	Angle(°)	Range	Sales Pkg Qty	Part No.
6	22.2	56	12.7	25	★★	1	D-48664
6	22.2	56	12.7	25	★★	1	D-68703
6	23	43	11	60	★★★	1	D-09494
6	25.4	51	11	45	★★	1	D-48658
6	25.4	51	11	45	★★	1	D-68694
6	26	42	9.5	45	★★★	1	D-09488

Shank dia. mm (inch)	Overall dia. mm (inch)	Length mm (inch)	Carbide Height mm (inch)	Angle(°)	Range	Sales Pkg Qty	Part No.
8	30.2	55	12.7	45	★★	1	D-48670
8	30.2	55	12.7	45	★★	1	D-68719
8	31.8	55	13.5	45	★★	1	D-48686
8	31.8	55	13.5	45	★★	1	D-68725
8	34.9	59	16	45	★★	1	D-48692
8	34.9	59	16	45	★★	1	D-68731
8	41.3	59	20	45	★★	1	D-48701
8	41.3	59	20	45	★★	1	D-68747
12	44.5	69	22.6	45	★★	1	D-48717
12	44.5	69	22.6	45	★★	1	D-68753
12	50.8	71	27	45	★★	1	D-48723
(1/4)	(7/8)	(2-3/16)	(1/2)	25	★★	1	D-49993
(1/4)	(7/8)	(2-3/16)	(1/2)	25	★★	1	D-69951
(1/4)	(1)	(2)	(3/8)	45	★★	1	D-49987
(1/4)	(1)	(2)	(3/8)	45	★★	1	D-69945
(1/4)	(1-1/8)	(2-7/64)	(7/16)	45	★★★	1	D-15506
(1/4)	(1-3/16)	(2-1/8)	(1/2)	45	★★	1	D-50005
(1/4)	(1-3/16)	(2-1/8)	(1/2)	45	★★	1	D-69967
(1/4)	(1-1/4)	(2-11/64)	(17/32)	45	★★	1	D-50011
(1/4)	(1-1/4)	(2-11/64)	(17/32)	45	★★	1	D-69973
(1/4)	(1-3/8)	(2-5/16)	(5/8)	45	★★	1	D-50027
(1/4)	(1-5/8)	(2-5/16)	(13/16)	45	★★	1	D-50033
(1/4)	(1-5/8)	(2-5/16)	(13/16)	45	★★	1	D-69989
(1/2)	(1-3/4)	(2-11/16)	(29/32)	45	★★	1	D-50049
(1/2)	(2)	(2-13/16)	(1-1/16)	45	★★	1	D-50055

Ogee bit



Shank dia. mm (inch)	Overall dia. mm (inch)	Length mm (inch)	Carbide Height mm (inch)	Radius1 (R)	Range	Sales Pkg Qty	Part No.
8	19	42	11	3.2	★★	1	D-48181
8	31.3	48	16	6.35	★★	1	D-48197
8	31.8	56	12.7	4.8	★★	1	D-48773
8	38.1	59	16	6.35	★★	1	D-48789
(1/4)	(3/4)	(1-11/16)	(7/16)	(1/8)	★★	1	D-49650
(1/4)	(3/4)	(1-11/16)	(7/16)	(1/8)	★★	1	D-69696
(1/4)	(1-15/64)	(1-7/8)	(5/8)	(1/4)	★★	1	D-49666
(1/4)	(1-1/4)	(2-3/16)	(1/2)	(3/16)	★★	1	D-50108
(1/4)	(1-1/2)	(2-5/16)	(5/8)	(1/4)	★★	1	D-50114
(1/4)	(1-1/2)	(2-5/16)	(5/8)	(1/4)	★★	1	D-70035
(1/2)	(3/4)	(1-15/16)	(7/16)	(1/8)	★★	1	D-63018

Roman ogee bit



Shank dia. mm (inch)	Overall dia. mm (inch)	Length mm (inch)	Carbide Height mm (inch)	Radius1 (R)	Radius2 (R)	Range	Sales Pkg Qty	Part No.
6	24	42	10	2.5	4.5	★★★	1	D-09575
6	25.4	52	9.5	3.2	3.2	★★	1	D-48804
6	28	44	12	3	6	★★★	1	D-09581
6	28.6	55	13	4	4	★★	1	D-48810
6	28.6	55	13	4	4	★★	1	D-68775
8	28.6	55	13	4	4	★★	1	D-48751
8	28.6	55	13	4	4	★★	1	D-68781
8	38.1	60	17.5	6.35	6.35	★★	1	D-48767
8	38.1	60	17.5	6.35	6.35	★★	1	D-68797
(1/4)	(1-1/8)	(2-11/64)	(1/2)	(5/32)	(5/32)	★★	1	D-50083
(1/4)	(1-1/8)	(2-11/64)	(1/2)	(5/32)	(5/32)	★★	1	D-70013
(1/4)	(1-1/2)	(2-3/8)	(11/16)	(1/4)	(1/4)	★★	1	D-50099
(1/4)	(1-1/2)	(2-3/8)	(11/16)	(1/4)	(1/4)	★★	1	D-70029

Roman ogee double bit



Shank dia. mm (inch)	Overall dia. mm (inch)	Length mm (inch)	Carbide Height mm (inch)	Radius1 (R)	Radius2 (R)	Range	Sales Pkg Qty	Part No.
(1/2)	(1-1/4)	(2-29/32)	(1-27/64)	(3/32)	(3/32)	★★	1	D-63161

Classic roman ogee bit

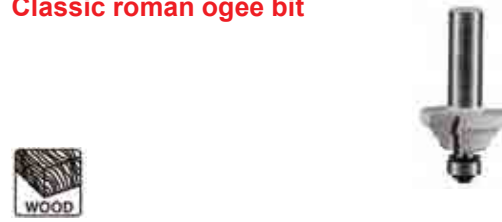

Shank dia. mm (inch)	Overall dia. mm (inch)	Length mm (inch)	Carbide Height mm (inch)	Radius1 (R)	Radius2 (R)	Range	Sales Pkg Qty	Part No.
(1/2)	(1-3/8)	(2-9/16)	(5/8)	(3/16)	(3/16)	★★	1	D-63236
(1/2)	(1-3/8)	(2-9/16)	(5/8)	(3/16)	(3/16)	★★	1	D-70150

Classic mold bit



Shank dia. mm (inch)	Overall dia. mm (inch)	Length mm (inch)	Carbide Height mm (inch)	Radius1 (R)	Radius2 (R)	Range	Sales Pkg Qty	Part No.
8	38.1	32	15.9	3.18	9.52	★★★	1	D-11704

Classical plunge bit



Shank dia. mm (inch)	Overall dia. mm (inch)	Length mm (inch)	Carbide Height mm (inch)	Radius1 (R)	Range	Sales Pkg Qty	Part No.
8	12.7	41.5	9.5	2	★★	1	D-48240
8	19	43.1	11	3.2	★★	1	D-48256
(1/4)	(1/2)	(1-5/8)	(3/8)	(5/64)	★★	1	D-49719
(1/4)	(3/4)	(1-11/16)	(7/16)	(1/8)	★★	1	D-49725
(1/4)	(3/4)	(1-11/16)	(7/16)	(1/8)	★★	1	D-69727

Classical bit



Shank dia. mm (inch)	Overall dia. mm (inch)	Length mm (inch)	Carbide Height mm (inch)	Radius1 (R)	Range	Sales Pkg Qty	Part No.
8	22	54	13	3.2	★★	1	D-48262
(1/4)	(7/8)	(2-1/8)	(1/2)	(1/8)	★★	1	D-49731

**Classic panel bit**



Shank dia. mm (inch)	Overall dia. mm (inch)	Length mm (inch)	Carbide Height mm (inch)	Radius1 (R)	Range	Sales Pkg Qty	Part No.
8	12.7	42	10	2.4	★★	1	D-48206
8	19	44.7	12.7	4	★★	1	D-48212
12	25.4	54	16	5.6	★★	1	D-48228
12	31.8	57	19	8.7	★★	1	D-48234
(1/4)	(1/2)	(1-21/32)	(3/8)	(3/32)	★★	1	D-49672
(1/4)	(1/2)	(1-21/32)	(3/8)	(3/32)	★★	1	D-69705
(1/4)	(3/4)	(1-3/4)	(1/2)	(5/32)	★★	1	D-49688
(1/2)	(1)	(2-1/8)	(5/8)	(7/32)	★★	1	D-49694
(1/2)	(1)	(2-1/8)	(5/8)	(7/32)	★★	1	D-69711
(1/2)	(1-1/4)	(2-1/4)	(3/4)	(11/32)	★★	1	D-49703

**Bull nose bit**



Shank dia. mm (inch)	Overall dia. mm (inch)	Length mm (inch)	Carbide Height mm (inch)	Radius1 (R)	Range	Sales Pkg Qty	Part No.
(1/2)	(3/4)	(2-9/16)	(5/8)	(1/8)	★★	1	D-63208
(1/2)	(7/8)	(2-3/8)	(3/4)	(1/8)	★★	1	D-63155
(1/2)	(7/8)	(2-15/16)	(1)	(3/16)	★★	1	D-63214
(1/2)	(1)	(2-15/16)	(1)	(1/4)	★★	1	D-63220

**Edge beading bit**



Shank dia. mm (inch)	Overall dia. mm (inch)	Length mm (inch)	Carbide Height mm (inch)	Radius1 (R)	Range	Sales Pkg Qty	Part No.
(1/2)	(1)	(2-5/8)	(11/16)	(3/16)	★★	1	D-63183
(1/2)	(1-1/8)	(2-11/16)	(3/4)	(1/4)	★★	1	D-63199

**Triple bead bit**



Shank dia. mm (inch)	Overall dia. mm (inch)	Length mm (inch)	Carbide Height mm (inch)	Radius1 (R)	Range	Sales Pkg Qty	Part No.
(1/2)	(7/8)	(2-61/64)	(1)	(1/8)	★★	1	D-63242

**Full bead bit**



Shank dia. mm (inch)	Overall dia. mm (inch)	Length mm (inch)	Carbide Height mm (inch)	Radius1 (R)	Range	Sales Pkg Qty	Part No.
8	25.4	61.2	13	4.8	★★	1	D-48826
(1/4)	(1)	(2-13/32)	(1/2)	(3/16)	★★	1	D-50136

**Handrail bit Type2**



Shank dia. mm (inch)	Overall dia. mm (inch)	Length mm (inch)	Carbide Height mm (inch)	Range	Sales Pkg Qty	Part No.
(1/2)	(1-3/8)	(3-7/16)	(1-1/2)	★★	1	D-63258

**Fish Handrail bit**



Shank dia. mm (inch)	Overall dia. mm (inch)	Length mm (inch)	Carbide Height mm (inch)	Range	Sales Pkg Qty	Part No.
8	19	67.1	26	★★	1	D-48832
12	28.6	90.2	41	★★	1	D-48848
(1/4)	(3/4)	(2-5/8)	(1)	★★	1	D-50142
(1/2)	(1-1/8)	(3-17/32)	(1-5/8)	★★	1	D-50158

**Multi edge beading bit**



Shank dia. mm (inch)	Overall dia. mm (inch)	Length mm (inch)	Carbide Height mm (inch)	Range	Sales Pkg Qty	Part No.
8	34.9	69.4	26	★★	1	D-48860
12	57.2	102.6	47.5	★★	1	D-48876
(1/4)	(1-3/8)	(2-3/4)	(1)	★★	1	D-50170
(1/2)	(2-1/4)	(4)	(1-7/8)	★★	1	D-50186
(1/2)	(2-1/4)	(4)	(1-7/8)	★★	1	D-70041

**French provincial classical bit**



Shank dia. mm (inch)	Overall dia. mm (inch)	Length mm (inch)	Carbide Height mm (inch)	Range	Sales Pkg Qty	Part No.
12	44.5	79.2	28.6	★★	1	D-48854
(1/2)	(1-3/4)	(3-1/8)	(1-1/8)	★★	1	D-50164

**Rabbeting bit**



Shank dia. mm (inch)	Overall dia. mm (inch)	Length mm (inch)	Carbide Height mm (inch)	Range	Sales Pkg Qty	Part No.
8	31.8	54.6	12.2	★★	1	D-48739
8	31.8	55	12.2	★★	1	D-68769
12	31.8	60.8	12.2	★★	1	D-48745
(1/4)	(1-1/4)	(2-1/8)	(1/2)	★★	1	D-50061
(1/4)	(1-1/4)	(2-1/8)	(1/2)	★★	1	D-69995
(1/2)	(1-1/4)	(2-3/16)	(1/2)	★★	1	D-50077
(1/2)	(1-1/4)	(2-3/16)	(1/2)	★★	1	D-70007

**Dovetail bit**



Shank dia. mm (inch)	Overall dia. mm (inch)	Length mm (inch)	Carbide Height mm (inch)	Angle( °)	Range	Sales Pkg Qty	Part No.
8	6.35	64	8	7.5	★★	1	D-48050
8	9.5	40	9.5	9	★★	1	D-48066
8	12.7	45	13	14	★★	1	D-48072
8	12.7	45	13	14	★★	1	D-68323
8	15	52	14.3	15	★★	1	D-48088
8	15	52	14.3	15	★★	1	D-68339
12	19	64	22.2	7	★★	1	D-48094
12	19	64	22.2	7	★★	1	D-68345
12	25.4	64	22.2	14	★★	1	D-48103
12	25.4	64	22.2	14	★★	1	D-68351
(1/4)	(1/4)	(2-1/2)	(5/16)	7.5	★★	1	D-49529
(1/4)	(1/4)	(2-1/2)	(5/16)	7.5	★★	1	D-69624
(1/4)	(3/8)	(1-9/16)	(3/8)	9	★★	1	D-49535
(1/4)	(3/8)	(1-9/16)	(3/8)	9	★★	1	D-69630
(1/4)	(1/2)	(1-3/4)	(1/2)	14	★★	1	D-49541
(1/4)	(1/2)	(1-3/4)	(1/2)	14	★★	1	D-69646
(1/4)	(19/32)	(2-3/64)	(9/16)	15	★★	1	D-49557
(1/2)	(3/8)	(2-1/8)	(3/8)	9	★★	1	D-62991
(1/2)	(3/8)	(2-1/8)	(3/8)	9	★★	1	D-69652
(1/2)	(1/2)	(2-1/4)	(1/2)	14	★★	1	D-63002
(1/2)	(3/4)	(2-1/2)	(7/8)	7	★★	1	D-49563
(1/2)	(1)	(2-1/2)	(7/8)	14	★★	1	D-49579

**Reversible glue joint bit**



Shank dia. mm (inch)	Overall dia. mm (inch)	Length mm (inch)	Carbide Height mm (inch)	Range	Sales Pkg Qty	Part No.
8	30.1	57.2	25.4	★★	1	D-48913
12	41.3	76.2	25.4	★★	1	D-48929
(1/2)	(1-5/8)	(3)	(1)	★★	1	D-50223
(1/2)	(1-5/8)	(3)	(1)	★★	1	D-70079

**Tongue and groove bit**



Shank dia. mm (inch)	Overall dia. mm (inch)	Length mm (inch)	Carbide Height mm (inch)	Range	Sales Pkg Qty	Part No.
12	41	38	6.35	★★★	1	D-12027
12	41	71	19	★★	1	D-48935
12	41	71	19	★★	1	D-68828
(1/2)	(1-39/64)	(2-51/64)	(3/4)	★★	1	D-50239
(1/2)	(1-39/64)	(2-51/64)	(3/4)	★★	1	D-70085

**Slotting cutter**



Shank dia. mm (inch)	Overall dia. mm (inch)	Length mm (inch)	Carbide Height mm (inch)	Range	Sales Pkg Qty	Part No.
8	47.6	59	2	★★	1	D-48941
8	47.6	59	2.5	★★	1	D-48957
8	47.6	59	3	★★	1	D-48963
8	47.6	59	3	★★	1	D-68834
8	47.6	59	4	★★	1	D-48979
8	47.6	59	4	★★	1	D-68840
8	47.6	59	5	★★	1	D-48985
8	47.6	59	5	★★	1	D-68856
8	47.6	59	5.5	★★	1	D-48991
(1/4)	(1-7/8)	(2-5/16)	(5/64)	★★	1	D-50245
(1/4)	(1-7/8)	(2-5/16)	(5/64)	★★	1	D-70091
(1/4)	(1-7/8)	(2-5/16)	(3/32)	★★	1	D-50251
(1/4)	(1-7/8)	(2-5/16)	(3/32)	★★	1	D-70100
(1/4)	(1-7/8)	(2-5/16)	(1/8)	★★	1	D-50267
(1/4)	(1-7/8)	(2-5/16)	(1/8)	★★	1	D-70116
(1/4)	(1-7/8)	(2-5/16)	(5/32)	★★	1	D-50273
(1/4)	(1-7/8)	(2-5/16)	(5/32)	★★	1	D-70122
(1/4)	(1-7/8)	(2-5/16)	(3/16)	★★	1	D-50289
(1/4)	(1-7/8)	(2-5/16)	(3/16)	★★	1	D-70138
(1/4)	(1-7/8)	(2-5/16)	(7/32)	★★	1	D-50295
(1/4)	(1-7/8)	(2-5/16)	(7/32)	★★	1	D-70144

**Reversible rail and stile bit**



Shank dia. mm (inch)	Overall dia. mm (inch)	Length mm (inch)	Carbide Height mm (inch)	Range	Sales Pkg Qty	Part No.
12	41	78.5	23.4	★★	1	D-48882
12	41	78.5	23.4	★★	1	D-48898
(1/2)	(1-5/8)	(3-3/32)	(29/32)	★★	1	D-50192
(1/2)	(1-5/8)	(3-3/32)	(29/32)	★★	1	D-50201
(1/2)	(1-5/8)	(3-3/32)	(29/32)	★★	1	D-70057

**Router bit set**

**22pc/ set**

											Shank size	Part No.
D: 20 B: 19	D: 16 B: 19	D: 12 B: 19	D: 10 B: 19	D: 8 B: 19	D: 6 B: 19	D: 4 B: 13	D: 3 B: 13	D: 17.3 R: 2.3 B: 8	D: 19 R: 3.2 B: 9.5	D: 25.4 R: 6.35 B: 13.5		
D: 22.2 R: 4.8 B: 12.7	D: 30.2 B: 12.7 A: 45°	D: 22.2 R: 4.8 B: 12.7	D: 12.7 R: 6.35 B: 10	D: 12.7 B: 16 A: 60°	D: 12.7 B: 12.7 A: 90°	D: 9.5 B: 26	D: 12.7 B: 26	D: 15 B: 14.3 A: 15°	D: 31.8 B: 12.2	D: 6.35 B: 19		

**22pc/ set**

											Shank size	Part No.
D: 12 B: 19	D: 10 B: 19	D: 8 B: 19	D: 6 B: 19	D: 6 B: 16	D: 6 B: 19	D: 5 B: 13	D: 6.35 R: 3.2 B: 6.35	D: 7.9 R: 4 B: 8	D: 12.7 R: 6.35 B: 10	D: 9.5 R: 4.8 B: 9.5		
D: 12.7 B: 16 A: 60°	D: 12.7 B: 12.7 A: 90°	D: 9.5 B: 26	D: 12.7 B: 13 A: 14°	D: 9.5 B: 9.5 A: 9°	D: 6.35 B: 8 A: 7.5°	D: 6.35 B: 19	D: 6.35 R: 3.2 B: 12.7	D: 9.5 R: 4.8 B: 12.7	D: 9.5 B: 10.5	D: 9.5 R: 4.8 B: 8.3		

**12pc/ set**

												Shank size	Part No.		
D: 12.7 R: 6.35 B: 8.8 L: 29.0	D: 16.0 B: 20.0	D: 6.0 B: 20.0 L: 25.0	D: 28.6 R: 9.5 B: 17.0 L: 25.5	D: 12.7 R: 9.5 A: 90° L: 29.0	D: 25.0 B: 16.0 L: 26.5	D: 22.2 R: 6.3 B: 13.5 L: 25.0	D: 22.0 R: 6.3 B: 12.7 L: 26.5	D: 12.7 R: 6.35 A: 14° L: 29.0	D: 32.0 B: 12.2 A: 45° L: 30.0	D: 12.7 B: 13.0	D: 12.0 B: 20.0 L: 28.0			8mm	A-88054
														6mm	A-87921
												1/4"	A-91051		

**12pc / set**

												Shank size	Part No.
D: 6 B: 16	D: 12 B: 19	D: 16 B: 19	D: 12.7 B: 13	D: 12.7 B: 13 A: 14°	D: 12.7 B: 12.7 A: 90°	D: 12.7 R: 6.35 B: 10	D: 25.4 R: 6.35 B: 13.5	D: 31.8 R: 9.5 B: 16.7	D: 31.8 B: 14	D: 31.5 R: 13.5 A: 45°	D: 28.6 R: 4 B: 13		
D: 1/4" B: 5/8"	D: 1/2" B: 3/4"	D: 5/8" B: 3/4"	D: 1/2" B: 1/2"	D: 1/2" B: 1/2" A: 14°	D: 1/2" B: 1/2" A: 90°	D: 1/2" B: 1/4" B: 3/8"	D: 1" R: 1/4" B: 17/32"	D: 1-1/4" R: 3/8" B: 21/32"	D: 1-1/4" R: 3/8" B: 17/32"	D: 1-1/4" R: 3/8" A: 45°	D: 1-1/8" R: 5/32" B: 1/2"	1/4"	D-53584

**12pc / set**

												Shank size	Part No.
D: 6 B: 19	D: 6 B: 16	D: 12 B: 32	D: 14 B: 19	D: 12.7 B: 13	D: 6.35 B: 12.7	D: 12.7 B: 12.7 A: 90°	D: 19 R: 3.2 B: 9.5	D: 25.4 R: 6.35 B: 13.5	D: 28.5 R: 7.9 B: 14.5	D: 25.4 B: 11 A: 45°	D: 25.3 R: 3.2 B: 9.5		

**6pc/ set**

**4pc/ set**

**3pc/ set**

						Shank size	Part No.					Shank size	Part No.				Shank size	Part No.
D: 6 B: 16	D: 10 B: 19	D: 12 B: 19	D: 12.7 R: 6.35 B: 10	D: 31.8 R: 9.5 R: 4 B: 13	D: 28.6 R: 4			8mm	D-53540	D: 19 R: 3.2 B: 9.5	D: 25.4 R: 6.35 B: 13.5			D: 31.8 R: 9.5 B: 16.7	D: 38.1 R: 12.7 B: 19	8mm		
D: 1/4" B: 5/8"	D: 3/8" B: 3/4"	D: 1/2" B: 3/4"	D: 1/2" R: 1/4" B: 3/8"	D: 1-1/4" R: 3/8" B: 21/32"	D: 1-1/8" R: 5/32" B: 1/2"	1/4"	D-53578	D: 3/4" R: 1/8" B: 3/8"	D: 1" R: 1/4" B: 17/32"	D: 1-1/4" R: 3/8" B: 21/32"	D: 1-1/2" R: 1/2" B: 3/4"	1/4"	D-53562	D: 1/4" B: 3/4"	D: 1/2" B: 1/2"	D: 1/2" B: 3/8" R: 1/4"	1/4"	D-70465

# ACCESSORIES

▣ Outdoor Power Equipment



## Blade Nut, Cup, Clamp Washer, Grass Guard and Receive Washer

\*with chisel blade (Arbor size 20mm)



\*\*\* Receive Washer with Grass Guard

Model No.	Spindle Size		1 Receive Washer			2 Blade Clamp Washer		3 Blade Cup		4 Blade Nut
			Arbor size (mm)	Size (mm)	Parts No.	Size (mm)	Parts No.	Size (mm)	Parts No.	Parts No.
DUR190L, DUR190U, DUR191L, DUR191U	M10x1.25LH	Rounded rectangle	25.4	---	***140T23-7	50	347668-4	68	168526-9	264025-0
DUR365U, DUR366L, UR006G, UR007G	M10x1.25LH	Spline 10T	25.4	42	**326518-6	50	346084-7	68	168526-9	264025-0
				---	***140L84-9					
DUR368A, DUR368L, UR002G, UR003G	M10x1.25LH	Spline 10T	25.4	---	***140L84-9	50	346084-7	68	168526-9	264025-0
DUR369A, DUR369L, UR101C, UR201C	M10x1.25LH	Spline 10T	25.4	64.5	144312-2	43	347104-0	68	457274-8	252236-9
UR012G	M10x1.25LH	Spline 10T	25.4	70.5	140J59-6	54.5	162567-7	Integreted with Blade Clamp Washer		252236-9
AC Brushcutter										
UR2300	M10x1.25LH	-	25.4	-	YA00000540	50	346084-7	68	168526-9	264025-0
UR3502	M10x1.25LH	-	-	-	YA00000540	-	-	-	-	-
Multi-tool attachments										
EM402MP	M10x1.25LH	Spline 10T	25.4	60	326821-5	50	346084-7	68	168526-9	264025-0
EM401MP	M10x1.25LH	Spline 10T	25.4	60	331861-0 326821-5	50	346084-7	68	168526-9	264025-0
EM403MP, EM404MP	M10x1.25LH	Spline 10T	25.4	64.5	144312-2	43	347105-8	68	457290-0	252236-9
EM405MP, EM406MP	M10x1.25LH	Spline 10T	-	64.5	144312-2	-	-	-	-	252236-9
EM408MP	M10x1.25LH	Spline 10T	25.4	64.5	140N88-3	43	347766-4	68	413201-5	252236-9
EM409MP	M10x1.25LH	Spline 10T	-	64.5	140N88-3	-	-	-	-	252236-9











## Edger

Model No.	Spindle Thread		Receive Washer			Blade Clamp Washer		Blade Nut
			Arbor size (mm)	Size (mm)	Parts No.	Size (mm)	Parts No.	Parts No.
EE400MP	M10x1.25LH	Spline 10T	25.4	54	326734-0	47	326381-7	264025-0

## Cordless string trimmer

Model No.	Spindle Size	Receive Washer		Grass Guard for Receive Washer	Model No.	Spindle Size	Receive Washer		Grass Guard for Receive Washer
		Size (mm)	Parts No.				Size (mm)	Parts No.	
DUR364L	M8x1.25RH	44	319245-2	346857-8	DUR184L	M8x1.25RH	36.5	326683-1 144512-4	346857-8
DUR366L	M10x1.25LH	42	326518-6	346622-5	DUR187L, DUR187U, DUR188L, DUR188U	M8x1.25LH	36.5	144512-4	346857-8
DUR369N, UR202C	M10x1.25LH	65	140N88-3		DUR189	M8x1.25RH	36.5	144512-4	346857-8
					DUR192L	M10x1.25LH	71	140W47-1	

**Blade selection guide**





Blade type / Image		Short and soft grass			Tall and hard grass			Bush including tree beginning to grow		
Nylon cord		←————→								
Plastic blade		←————→								
Metal blade		←————→								
		←————→								
				←————→						
Brushcutter blade				←————→			←————→			
Shredder blade							←————→			
Saw blade								←————→		
Chisel blade								←————→		
T.C.T. saw blade		←————→								



## Brushcutter blades

Hole Dia.: 25.4mm

\* Carton pakage \*\* Clamshell pakage

	Blade dia. / No. of teeth	Thickness	Model No.	Part No.
<b>2-tooth blade</b> 	230mm / 2	2.0mm	DUR369A, DUR369L, UR006G, UR007G, UR101C, UR201C, EM400MP, EM401MP, EM402MP, EM403MP, EM404MP	*197997-3 **D-66058
	255mm / 2	2.0mm	DUR369A DUR369L, UR006G, UR007G, UR101C, UR201C	*198345-9 **D-66064
	305mm / 2	2.0mm	UR012G	195624-6
<b>4-tooth blade</b> 	230mm / 4	1.8mm	DUR368A, DUR368L, DUR369A, DUR369L, UR002G, UR003G, UR006G, UR007G, UR101C, UR201C, EM400MP, EM401MP, EM402MP, EM403MP, EM404MP	*195150-5 **D-66008
	255mm / 4	2.0mm	DUR369A, DUR369L, EM3400U/L, UR006G, UR007G, UR101C, UR201C	197320-2
	255mm / 4	2.0mm	DUR369A, DUR369, UR006G, UR007G, UR101C, UR101C, UR201C	*196895-8 **D-66014
<b>8-tooth blade</b> 	200mm / 8	1.4mm	DUR194	191Y44-2
	230mm / 8	1.8mm	EM400MP, EM401MP, EM402MP, EM403MP, EM404MP	D-73324
<b>3-tooth blade</b> 	230mm / 3	3.0mm	DUR368A, DUR368L, DUR369A, DUR369L, UR002G, UR003G, UR006G, UR007G, UR101C, UR201CEM400MP, EM401MP, EM402MP, EM403MP, EM404MP	D-66020
	255mm / 3	3.0mm	UR006G, UR007G, UR101C, UR201C	D-66036
	305mm / 3	3.0mm	UR012G	*195300-2 **D-66042
<b>Saw blade</b> 	230mm / 80	1.8mm	DUR368A	D-73879
	255mm / 80	2.0mm	DUR369A	D-73885

### TCT Saw blade



Not available in some countries due to local regulation

230mm / 36	1.25mm	DUR369A, DUR369L, UR101C, UR201C	D-65981
255mm / 40	1.25mm	DUR369A, DUR369L, UR002G, UR003G, UR006G, UR007G, UR101C, UR201C,	D-65997

### Edger blade



Blade dia. / No. of teeth	Thickness	Model No.	Part No.
203mm / 2	2.5mm	EE400MP	196745-7

## Special blade & Protection guard

### Chisel blade



For brush and thin tree trunks and new growth. Not available in some countries due to local regulation

Model No.	Blade					Protection guard			
	Blade dia		Arbor size	Thickness	Part No.		Description	Pipe size	Part No.
UR012G	225mm		25.4mm	1.8mm	199872-9		Without protector clamp	28mm	199873-7

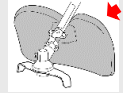
### Shredder blade

Model No.	Blade					Protection guard			
	Blade dia		Arbor size	Thickness	Part No.		Description	Pipe size	Part No.
UR012G	270mm		25.4mm	3.9mm	199874-5		Without protector clamp	28mm	199875-3

### Rotary scissors

Model No.	Blade					Protection guard			
	Blade dia				Part No.		Description	Pipe size	Part No.
EM407MP	230mm				A : SY00146013 B : SY00146014		Without protector clamp	24mm	412999-1

## String trimmer head

### Quick loading Trimmer Head

(UN-74L, UN-72L, 96-M8L/R, 96-M10L, 121-M10L)

Nylon cord can be feeded without opening the head



0 85(sec.)



0 35(sec.)



**Up to 58% less feeding time!**

## String trimmer head



\* with adapter (Poly bag with header)

Eyelet 2pcs/set for Bump & Feed 4L/4R/Z5L, Ultra Auto 4R/4L/6L Part No. A-15992





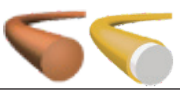

Description	Ref.	Size	Thread size	Model No.	Cord/ Line	Cord shape	Part No.
<b>Quick loading Bump &amp; Feed</b> 	96-M8R	4"	M8x1.25RH	DUR189	2.0mm x 4m	Four-leaf	191D92-5
	96-M8L	4"	M8x1.25LH	DUR187L	2.0mm x 4m	Four-leaf	191D91-7
	96-M10L	4"	M10x1.25LH	DUR190L, DUR190U, DUR191L, DUR191U, DUR192L, DUR368A, DUR368L, DUR369A, DUR369L, DUR369N, UR002G, UR003G, UR006G, UR007G, UR101C, UR201C, UR202C, EM400MP, EM401MP, EM403MP, EM404MP, EM405MP, EM406MP, EM408MP, EM409MP	2.0mm x 4m	Four-leaf	191D89-4 191R00-0
					2.4mm x 3m	Four-leaf	191D90-9
121-M10L	5"	M10x1.25LH	UR012G	2.4mm x 4m	Four-leaf	191D93-3	
<b>Bump &amp; Feed</b> 	UN-74L	4.4"	M10x1.25LH	DUR190L, DUR366L, DUR368A, DUR368L, DUR369A, DUR369L, DUR369N, UR002G, UR003G, UR101C, UR201C, UR202C, EM400MP, EM401MP, EM403MP, EM404MP, EM405MP, EM406MP	2.4mm x 3.6m	Four-leaf	196324-1
	UN-72L/ 110-M10L	5"	M10x1.25LH	DUR369A, DUR369L, DUR369N, UR006G, UR007G, UR101C, UR201C, UR202C	2.4mm x 6m	Four-leaf	198266-5
<b>Bump &amp; Feed</b> 	76-M8R	3"	M8x1.25RH	UR100D	1.65mm x 8m	Four-leaf	198853-0 EU:198854-8
	95-M8R	4"	M8x1.25RH	DUR189	2.0mm x 3m	Four-leaf	198972-2 EU:198971-4
	95-M8L	4"	M8x1.25LH	DUR187U/L, DUR188U/L, EM2500U/L, EM2600U/L	2.0mm x 3m	Four-leaf	198386-5 EU:198385-7 198892-0 EU:198893-8
<b>Bump &amp; Feed</b> 	95-M10L	4"	M10x1.25LH	DUR190L, DUR190U, DUR191L, DUR191U, DUR192L, DUR365U, DUR366L, DUR368A, DUR368L, DUR369A, DUR369L, DUR369N, UR002G, UR003G, UR006G, UR007G, UR101C, UR201C, UR202C, EM400MP, EM401MP, EM403MP, EM404MP, EM405MP, EM406MP, EM408MP, EM409MP	2.0mm x 3m	Four-leaf	197804-0 EU:197993-1
					2.4mm x 3m	Four-leaf	
<b>Bump &amp; Feed</b> 	Bump & Feed ECO 4R	4" Low profile	M8x1.25RH	DUR189	2.0mm x 3m	Four-leaf	197297-1
	Bump & Feed ECO 4L	4" Low profile	M8x1.25LH	DUR187L	2.0mm x 3m	Round	196589-5
	Bump&Feed B&F Eco4	4"	M8x1.25LH	DUR362,DUR363,DUR369,	2.7mmx3m	Square	196871-2
	Bump & Feed ECO 4L	4" Low profile	M10x1.25LH	DUR192L, DUR368A, DUR368L, DUR369A, DUR369L, DUR369N, UR002G, UR003G, UR006G, UR007G, UR101C, UR201C, UR202C, EM408MP, EM409MP	2.0mm x 3m	Four-leaf	197296-3
	Bump & Feed Z5L/ 105-M10L	5"	M10x1.25LH	EM400MP, EM401MP, EM403MP, EM404MP, EM405MP, EM406MP	2.4mm x 3m	Four-leaf	B-05131
UR012G					2.7mm x 3m	Four-leaf	199884-2
<b>Automatic feed and Bump &amp; Feed</b> 	Ultra Auto 4R	4"	M8x1.25RH	ER2550L, ER2650L, ER2600L, ER400MP	2.4mm x 3m	Round	B-03006
	Ultra Auto 4L	4"	M8&10x1.25LH	DUR187U/L, DU188U/L, EM400MP, EM401MP, EM403MP, EM404MP, EM405MP, EM406MP	2.4mm x 3m	Round	*B-02945
					2.4mm x 3m	Round	B-05125
Ultra Auto 6L	6"	M10x1.25LH	EBH340R, EBH341U/L/R, EM4350UH/LH/RH, EM4351UH, RBC411U, RBC412U, RBC413U, RBC414U	3.0mm x 2m	Round	*A-81658	

Line will be feeded about 3cm, in either one of the following cases  
 -Head rotation are reached at 8,500rpm.  
 -Bottom of the head is bumped on the ground when it is spinning.

**Line character**

Shape	Sharpness	Energy Saving	Quietness
Round 		A	A
Square 	AA		
Four-leaf 	A	AA	AA

**Color chart**

Dia.	Color / Shape	Light duty		Heavy duty	
		Low density	High density	Low density	High density
1.3mm		↔			
1.6mm - 1.65mm		↔↔			
2.0mm			↔↔↔		
2.4mm			↔↔↔↔		
2.7mm				↔↔↔↔↔	
3.0mm					↔↔↔↔↔↔

**Four-Leaf Line**

Low noise and energy saving

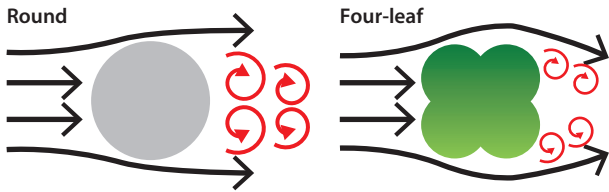

Four-leaf shape makes small vortex and realizes low noise and energy saving feature thanks to less air resistance.

The amount of cutting per 1 charge

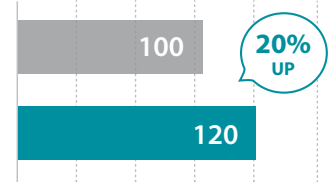

Noise

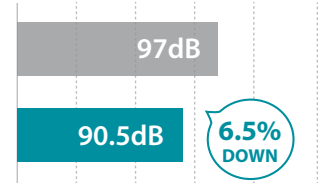

**Standard Nylon cord**

Color / Shape	Ring (mm)	dia. (mm)	length (m)	Part No.
	Single	1.3	15	E-02727
	Single	1.6	15	E-02733
	Single	2.0	15	E-02705
	Single	2.0	126	E-02711
	Single	2.4	15	E-02749
	Single	2.4	87	E-02761
	Single	2.4	262	E-02783
	Single	2.4	15	E-02808
	Single	2.4	69	E-02814
	Single	2.4	206	E-02820

**Four-leaf Spiral Nylon cord**

Color / Shape	Ring (mm)	dia. (mm)	length (m)	Part No.
	Single	1.65	15	E-01731
	Single	1.65	30	E-01747
	Single	1.65	445	E-01753
	Single	2.0	15	E-01769
	Single	2.0	30	E-01775
	Single	2.0	310	E-01781
	Single	2.4	15	E-01797
	Single	2.4	30	E-01806
	Single	2.4	225	E-01812
	Single	2.7	15	E-01828
	Single	2.7	30	E-01834
	Single	2.7	180	E-01840

**Double-layer Nylon cord**

Increased durability up to 130%\* thanks to Flexible core coated with Impact & abrasion resistant skin  
\*compared to standard nylon cord

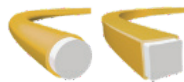

Color / Shape	Ring (mm)	dia. (mm)	length (m)	Part No.
	Single	3.0	15	E-02836
	Single	3.0	56	E-02842
	Single	3.0	168	E-02858
	Single	3.0	15	E-02870
	Single	3.0	44	E-02886
	Single	3.0	132	E-02892

**Other Nylon cord (round, natural)**



Size	Part No.
1.65mmx15m	DA00000003
2.4mmx5m	B-01971
3.0mmx4m	B-07375

**Spool assembly**



Model.No.	Card/line	Cord shape	Part no
DUR180,DUR181	1.65mmx8m	Round	196871-2
DUR100	1.65mmx8m	Four-leaf	198853-0 EU:198854-8
DUR193D	1.65mmx8m	Four-leaf	191Y39-5

**Plastic blade set**



Model No.	Plastic blade set			Replacement plastic blade	
	Arbore size	Cutting width	Part No.	per pkg.	Part No.
UR100D	M8x1.25RH	230mm	198848-3	5	198850-6 EU:198851-4
DUR187L, DUR187U, DUR188L, DUR190L, DUR190U, DUR191L, DUR191U, DUR188U, DUR189, DUR364L, DUR366L, DUR368A, DUR368L, DUR369A, DUR369L, DUR369N, UR001G, UR002G, UR003G, UR006G, UR007G, UR008G, UR101C, UR201C, UR202C, EM403MP, EM404MP, EM405MP, EM406MP, DUR369A, DUR369L, DUR369N, UR101C, UR201C, UR202C, UR012G	M8x1.25RH M8x1.25LH M10x1.25LH	255mm	198383-1	12	198426-9
	M10x1.25LH	305mm	199868-0	12	199870-3

**Multi-tool attachments**

Model	item	Recommend power unit models
EM401MP	Brushcutter Cutting width: 300mm (String trimmer head) : 230mm (Brush cutter blade size) Spindle size: M10 x 1.25LH Arbor size:25.4mm Gear ratio : 0.74 (14 : 19)	DUX60, UX01G
EM402MP	Brushcutter Blade size: 230mm (Brushcutter blades) Spindle size: M10 x 1.25LH Arbor size:25.4mm Gear ratio : 0.74 (14 : 19)	DUX60
EM403MP	Brushcutter Cutting width: 450mm (String trimmer head) : 230mm (Brush cutter blade size) Spindle size: M10 x 1.25LH Arbor size:25.4mm Gear ratio EM403MP : 0.74 (14 : 19) High speed type	DUX60, UX01G
EM404MP	Brushcutter Cutting width: 450mm (String trimmer head) : 230mm (Brush cutter blade size) Spindle size: M10 x 1.25LH Arbor size:25.4mm Gear ratio EM404MP : 0.62 (13 : 21) High torque & Low noise type	DUX60 with CE mark, UX01G with CE mark

Model	item	Recommend power unit models
EM405MP	Brushcutter (Narrow guard for String trimmer head) Cutting width: 450mm Spindle size: M10 x 1.25LH Gear ratio EM405MP : 0.74 (14 : 19) High speed type EM406MP : 0.62 (13 : 21) High torque & Low noise type	DUX60, UX01G
EM406MP		DUX60 with CE mark, UX01G with CE mark,
EM407MP	Rotary scissors attach Set Cutting width: 230mm  Stone & grass antiscattering brushcutter attachment.	DUX18, DUX60, UX01G
EM408MP	Brushcutter Cutting width: 300mm (String trimmer head) : 230mm (Brush cutter blade size) Spindle size: M10 x 1.25LH Arbor size:25.4mm Gear ratio : 0.74 (14 : 19)	DUX18, DUX60, UX01G
EM409MP	Brushcutter (Narrow guard for String trimmer head) Cutting width: 300mm Spindle size: M10 x 1.25LH Gear ratio : 0.74 (14 : 19)	DUX18, DUX60, UX01G
UB400MP	Blower *Except for European, Austrarian, Newzealand, Chinese & Korean markets .	DUX18, DUX60, UX01G
UB401MP	Blower	DUX18, DUX60, UX01G
EY401MP	Pole saw Guide bar length: 25cm (10") Saw chain: 91VXL-39links Motor Mount:A218	DUX18, DUX60, UX01G
EY402MP	Pole saw Guide bar length: 25cm (10") Saw chain: 90PX-40links Motor Mount:A041	DUX18, DUX60, UX01G
EY403MP	Pole saw Guide bar length: 30cm (12") Saw chain: 90PX-46links or 91PX-46links Motor Mount:A41	DUX18, DUX60, UX01G
EN401MP	Pole hedge trimmer Angle adjustment	DUX18, DUX60, UX01G
EN410MP	Pole hedge trimmer Straight	DUX18, DUX60, UX01G
EN420MP	Ground trimmer	DUX18, DUX60, UX01G

Model	item	Recommend power unit models
KR400MP	 Cultivator Cultivating width: 160mm	DUX18, DUX60, UX01G
KR401MP	 Cultivator Cultivating width: 220mm * Rotor LR set : P/N : 199204-0	DUX18, DUX60, UX01G
BR400MP	 Power brush * Brush wheel (1pc) P/N : XNR0000548	DUX18, DUX60, UX01G
SW400MP	 Power sweep * Sweeper wheel (1pc) : P/N : XNR0000549	DUX18, DUX60, UX01G
EJ400MP	 Coffee harvester	DUX18, DUX60, UX01G
EE400MP	 Edger attachment	DUX18, DUX60, UX01G
LE400MP	 Shaft extension attachment (1.08m (42-1/2" ) ) For Pole saw, Pole hedge trimmer and Coffee harvester	DUX18, DUX60, UX01G

### Shoulder strap assembly

\*Poly bag with header

Type	Model No.	Part No.
Single 	DUA250, DUA251, DUA300, DUA301, DUN500W DUN501W, DUR181, DUR184L, DUR187L, DUR188L, DUR189, DUR190L, DUR191L, DUR192L, DUR194, DUR368A, DUR368L, DUR369A, DUR369L, UA001G, UA002G, UA003G, UA004G; UR100D, DUX60	125516-5
	DUR192L, DUR194, UR002G, UR003G; UR006G, UR007G, DUR193, DUR194, UX18D	127508-0
Single 	DUR190L, DUR190U, DUR191U, DUR369A, DUR369L, UR006G, UR007G	125520-4
Comfort 	DUR369A, UR002G, UR006G, UR007G	122906-3
Comfort 	DUR369A, UR006G, UR007G	*199378-7
	DUR368U, DUR369U, UR006G, UR012D	122A37-4

### String trimmer harness for PDC01 & PDC1200

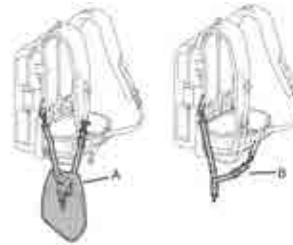

Type	Part No.
A	125516-5
B	127508-0

## Saw Chain and Guide Bar



**A Guide Bar Length**  
Guide bar's length is represented by cutting length, which is different from its total length.



**B Drive Link**  
The length of saw chain is determined by counting the number of drive links in the saw chain.

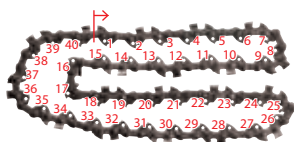

**C Chain Pitch**  
Chain pitch is the size of the chain and it is defined by the distance between any three consecutive rivets divided by two. Pitch is important because the drive sprocket must be the same pitch as the chain.



**D Gauge**  
Chain Gauge is thickness of drive link which will fit into the guide bar groove. Chain gauge must be the same as guide bar gauge.

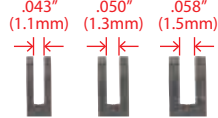

**E Depth Gauge**  
Depth gauge determines how deep the cutting teeth gets into the wood. Cutting depth can be checked by the gap between top of cutter and depth gauge.



### General Saw Chain Character

<b>C Chain Pitch</b>	<b>D Gauge</b>				
		0.043" (1.1mm)	0.050" (1.3mm)	0.058" (1.5mm)	0.063" (1.6mm)
	1/4"	25AP 25F			
	.325"LP	80			
	3/8"LP	90PX	91PX 91F 91VXL		
	.325"		20BPX 95VPX	21BPX 21LPX	22BPX 22LPX
	3/8"		72LPX 72V	73DPX 73LGX 73LPX	75LPX 75LPX
.404"				27X 59AC	

## Guide Bar Type

### Sprocket Nose Bars

Sprocket nose bars have a rotating sprocket mounted at the tip of the bar. As the chain moves along the bar, the sprocket teeth carry the chain around the tip smoothly with less friction.



### Hard Nose Bars(Solid Bar)

High wear resistant stellite has been welded onto the tip. Hard nose bars are made for special applications, such as fire-damaged forests, deserts, or sandy environments.



### Carving Bars

Carving bars are made of high-quality steel and high wear resistant stellite has been welded onto the tip. Bar tip is designed to have small radius for precision cutting. The carving bars are made for especially pruning and carving.



## Guide Bar Maintenance

### Chain Tension

Check the chain tension before use. The saw chain may become loose after many hours of use.



### File Bar Edge

File bar edge with a flat file to keep it 90° once a week.



### Clean Guide Bar

Clean out chips and sawdust every time when you sharpen or replace saw chain.



### Bar Nose Grease

Lubricate a whole sprocket regularly so that the saw chain can rotate with less friction.



## Sharpening Saw Chain

### Round File and File holder



The file can be guided more easily if a file holder is employed. The file holder has markings for the correct sharpening angle of 30° (align the markings parallel to the saw chain) and limits the depth of penetration (to 4/5 of the file diameter).

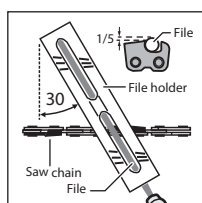

### Depth gauge jointer

After sharpening the chain, check the height of the depth gauge using the chain gauge tool.

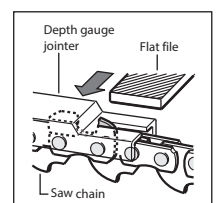
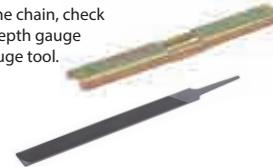

### Flat file

## Chain Saws

### Guide Bar / Saw Chain / Guide Bar Cover / Drive sprocket

Cutter type: CC: Chamfer chisel, SC: Semi chisel, MC : Micro chisel, FC: Full chisel

\* Pole saw attachment



Model No.	Guide Bar						Saw Chain						Bar Cover	Drive sprocket	
	Bar length	Motor Mount	Type	Drive tooth	Part No.	No. of drive links	Gauge	Pitch	Type	Cutter type	Part No. (Carton)	Low kickback saw chain (ANSI / CSA)	Part No.	Type	Part No.

#### Pole Saws

*EY401MP	25cm/10"	A218	Sprocket nose bar	7	191G11-9	39	1.3mm/.050"	3/8" LP	91VXL	SC	191H20-4		452093-7 458501-6	Sprocket 3/8"LP	XTM000014
*EY402MP *EY403MP DUA250 DUA251 DUA300 DUA301 UA001G UA002G UA003G UA004G	25cm/10"	A041	Sprocket nose bar	7	191G14-3	40	1.1mm/.043"	3/8" LP	90PX	CC	191H00-0	YES	458501-6	Sprocket 3/8"LP	226992-7
	30cm/12"	A041		7	191G15-1	46					191H01-8	YES	419288-5		
	25cm/10"	A041		7	191G22-4	40	1.3mm/.050"	91PX	CC	191H08-4	YES	458501-6			
	30cm/12"	A041		7	191G23-2	46				191H10-7	YES	419288-5			

#### Cordless Chain Saws

DUC121, DUC122	16cm/ 6-1/4"	—	without sprocket	—	191G59-1	42	1.3mm/.050"	1/4"	25AP	MC	191G95-7		416311-7	Sprocket 1/4"	221527-9	
DUC204 DUC254 DUC254C	25cm/10"	—	Solid carving bar	—	191G61-4	60	1.3mm/.050"	1/4"	25AP	MC	191G96-5		452093-7	Sprocket 1/4"	198259-2	
	20cm/8"	A041	Sprocket nose bar	7	191G13-5	33	1.1mm/.043"	3/8" LP	90PX	CC	191G99-9		458503-2	Sprocket 3/8"LP	199063-2	
	25cm/10"	A041		7	191G14-3	40					191H00-0		452093-7			
	30cm/12"	A041		7	191G15-1	46	191H01-8		419288-5							
	25cm/10"	A041		7	191G18-5	40	1.3mm/.050"	3/8" LP	91PX	CC	191H08-4		452093-7			
UC002G UC003G UC004G UC006G UC007G	25cm/10"	—	Solid carving bar	—	191G61-4	60	1.3mm/.050"	1/4"	25AP	MC	191G96-5		452093-7	Sprocket 1/4"	191V92-3	
	30cm/12"	A041	Sprocket nose bar	8	191T86-6	51	1.1mm/.043"	.325" LP	80TXL	MC	191T90-5	YES	419288-5	Sprocket .325"LP	191V91-5	
	35cm/14"	A041		8	191T87-4	59					191T91-3	YES	419288-5			
	40cm/16"	A041		8	191T88-2	64					191T92-1	YES	419242-9			
	UC002G UC003G UC004G UC006G UC007G	25cm/10"	A041	Sprocket nose bar	7	191G14-3	40	1.1mm/.043"	3/8" LP	90PX	CC	191H00-0	YES	452093-7	Sprocket 3/8"LP	191V90-7
		30cm/12"	A041		7	191G15-1	46					191H01-8	YES	419288-5		
		35cm/14"	A041		7	191G16-9	52					191H02-6	YES	419288-5		
		40cm/16"	A041		7	191G17-7	56					191H03-4	YES	419242-9		
		25cm/10"	A041	Sprocket nose bar	7	191G22-4	40	1.3mm/.050"	3/8" LP	91PX	CC	191H08-4	YES	452093-7		
		30cm/12"	A041		7	191G23-2	46					191H10-7	YES	419228-5		
35cm/14"		A041	7		191G24-0	52	191H11-5					YES	419288-5			
40cm/16"	A041	7	191G25-8	56	191H12-3	YES	419242-9									
DUC252 DUC302 DUC352 DUC252C	25cm/10"	—	Solid carving bar	—	191G61-4	60	1.3mm/.050"	1/4"	25AP	MC	191G96-5		452093-7	Sprocket 1/4"	221528-7	
	25cm/10"	A041	Sprocket nose bar	7	191G14-3	40	1.1mm/.043"	3/8" LP	90PX	CC	191H00-0	YES	452093-7	Sprocket 3/8"LP	221526-1	
	30cm/12"	A041		7	191G15-1	46					191H01-8	YES	419288-5			
	35cm/14"	A041		7	191G16-9	52	191H02-6	YES	419288-5							
	25cm/10"	A041		7	191G22-4	40	1.3mm/.050"	3/8" LP	91PX	CC	191H08-4	YES	452093-7			
	30cm/12"	A041	Sprocket nose bar	7	191G23-2	46	1.3mm/.050"	3/8" LP	91PX	CC	191H10-7	YES	419288-5			
	35cm/14"	A041		7	191G24-0	52					191H11-5	YES	419288-5			
40cm/16"	A041	7		191G25-8	56	191H12-3					YES	419242-9				
DUC256 DUC306 DUC356 DUC406 DUC256C	25cm/10"	—	Solid carving bar	—	191G61-4	60	1.3mm/.050"	1/4"	25AP	MC	191G96-5		452093-7	Sprocket 1/4"	198259-2	
	25cm/10"	A041	Sprocket nose bar	7	191G14-3	40	1.1mm/.043"	3/8" LP	90PX	CC	191H00-0	YES	452093-7	Sprocket 3/8"LP	199063-2	
	30cm/12"	A041		7	191G15-1	46					191H01-8	YES	419288-5			
	35cm/14"	A041		7	191G16-9	52					191H02-6	YES	419288-5			
	40cm/16"	A041	7	191G17-7	56	191H03-4	YES	419242-9								
	25cm/10"	A041	Sprocket nose bar	7	191G22-4	40	1.3mm/.050"	3/8" LP	91PX	CC	191H08-4	YES	452093-7			
	30cm/12"	A041		7	191G23-2	46					191H10-7	YES	419228-5			
	35cm/14"	A041		7	191G24-0	52					191H11-5	YES	419288-5			
40cm/16"	A041	7		191G25-8	56	191H12-3					YES	419242-9				

Model No.	Guide Bar						Saw Chain						Bar Cover	Drive sprocket	
	Bar length	Motor Mount	Type	Drive tooth	Part No.	No. of drive links	Gauge	Pitch	Type	Cutter type	Part No. (Carton)	Low kickback saw chain (ANSI / CSA)		Part No.	Type
DUC303 DUC353 DUC400 DUC305 DUC355 DUC405	25cm/10"	---	Solid carving bar	---	191G61-4	60	1.3mm/.050"	1/4"	25AP	MC	191G96-5		452093-7	Sprocket 1/4"	198259-2
	30cm/12"	A041	Sprocket nose bar	7	191G15-1	46	1.1mm/.043"	3/8" LP	90PX	CC	191H01-8	YES	419288-5	Sprocket 3/8"LP	199063-2
	35cm/14"	A041		7	191G16-9	52					191H02-6	YES	419288-5		
	40cm/16"	A041		7	191G17-7	56					191H03-4	YES	419242-9		
	30cm/12"	A041	Sprocket nose bar	7	191G23-2	46	1.3mm/.050"	3/8" LP	91PX	CC	191H10-7	YES	419228-5		
	35cm/14"	A041		7	191G24-0	52					191H11-5	YES	419288-5		
	40cm/16"	A041		7	191G25-8	56					191H12-3	YES	419242-9		
7				191G26-6	62	191H13-1					YES	419242-9			
UC010G UC011G UC012G UC013G UC014G UC015G UC016G UC017G UC020G	30cm/12"	A041	Sprocket nose bar	8	191T86-6	51	1.1mm/.043"	.325" LP	80TXL	MC	191T90-5	YES	419288-5	Sprocket .325"LP	191V91-5
	35cm/14"	A041		8	191T87-4	59					191T91-3	YES	419288-5		
	40cm/16"	A041		8	191T88-2	64					191T92-1	YES	419242-9		
	45cm/18"	A041	Sprocket nose bar	8	191X03-0	70	1.1mm/.043"	3/8" LP	90PX	CC	80TXL	MC	191X04-8	YES	419242-9
	30cm/12"	A041		7	191G15-1	46					191H01-8	YES	419288-5		
	35cm/14"	A041		7	191G16-9	52					191H02-6	YES	419288-5		
	40cm/16"	A041		7	191G17-7	56					191H03-4	YES	419242-9		
	30cm/12"	A041	Sprocket nose bar	7	191G23-2	46	1.3mm/.050"	3/8" LP	91PX	CC	191H10-7	YES	419228-5	Sprocket 3/8"LP	191V90-7
	35cm/14"	A041		7	191G24-0	52					191H11-5	YES	419288-5		
	40cm/16"	A041		7	191G25-8	56					191H12-3	YES	419242-9		
	45cm/18"	A041		7	191G26-6	62					191H13-1	YES	419242-9		
				7	191G26-6	62					191H13-1	YES	419242-9		

Electric Chain Saws

UC3041A, UC3541A, UC4041A	30cm/12"	A041	Sprocket nose bar	7	191G15-1	46	1.1mm/.043"	3/8"	90PX	CC	191H01-8	YES	419288-5	Sprocket 3/8"LP	221526-1
	35cm/14"	A041		7	191G16-9	52					191H02-6	YES	419288-5		
	40cm/16"	A041		7	191G17-7	56					191H03-4	YES	419242-9		
	30cm/12"	A041	Sprocket nose bar	7	191G23-2	46	1.3mm/.050"	3/8"	91PX	CC	191H10-7	YES	419288-5		
	35cm/14"	A041		7	191G24-0	52					191H11-5	YES	419288-5		
	40cm/16"	A041		7	191G25-8	56					191H12-3	YES	419242-9		
UC3050A, UC3550A, UC4050A, UC4550A, UC3051A, UC3551A, UC4051A, UC4551A	30cm/12"	A041	Sprocket nose bar	7	191G23-2	46	1.3mm/.050"	3/8"	91PX	CC	191H10-7	YES	419288-5	Sprocket 3/8"LP	221521-1
	35cm/14"	A041		7	191G24-0	52					191H11-5	YES	419288-5		
	40cm/16"	A041		7	191G25-8	56					191H12-3	YES	419242-9		
	45cm/18"	A041	High durability sprocket nose bar	7	191G26-6	62	191H13-1	YES	419242-9						
	35cm/14"	A041		9	191G33-9	52	191H11-5	YES	419288-5						
40cm/16"	A041	9	191G34-7	56	191H12-3	YES	419242-9								
5012B	30cm/12"	---	High durability sprocket nose bar	9	191G63-0	45	1.3mm/.050"	3/8"	91PX	CC	191H09-2	YES	410054-3	Sprocket 3/8"LP	221514-8

**Solid carving bar**

250mm: Part No. 191G61-4



Saw Chain: 25AP-60 links  
Part No. 191G96-5



Drive sprocket: 1/4" 9T  
DUC204, DUC254, DUC254C, DUC303, DUC353, DUC400, DUC305, DUC355, DUC405, DUC256, DUC306, DUC356, DUC406, DUC256C: Part No. 198259-2

DUC252, DUC302, DUC352, DUC252C: 221528-7

UC002G, UC003G, UC004G, UC006G, UC007G: 191V92-3



**Tie Strap & Tie Strap with Rivets**

Saw chain type	pitch	gauge	Tie Strap (1pc)	Tie Strap with Rivets (1pc)
			Part No.	Part No.
25AP	1/4"	1.3mm/.050"	558466000	558466010
90PX	3/8"LP	1.1mm/.043"	510090030	510090010
91PX, 91VXL, 492, 196	3/8"LP	1.3mm/.050"	558092000	558092010

### Round File, File holder

For Model:  
Chain saw  
\*with handle

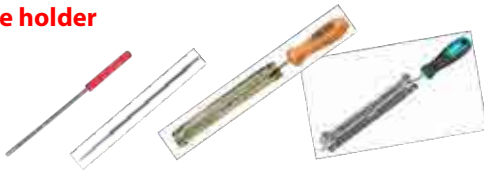

Saw chain type	Round file			File and File handle and File holder
	Size	Part No.	Q'ty	Part No.
25F, 25AP, 91P, 91PX, 91PXL, 91VXL, M91VXL	4.0mm	*744003-1	1	-
		953003090	1	195089-2 953030010
		D-67359	2	D-70948
		D-67365	12	
90PX, 90SG	4.5mm	53003100	1	195923-6 953030020
		D-67371	2	D-70954
		D-67387	12	

### Round file bit

For all saw chain



Description	Part No.
φ4.0mm (5/32") Round File bit 6.35mm (1/4") Hex shank	D-73748
φ4.5mm (11/64") Round File bit 6.35mm (1/4") Hex shank	D-73754
φ4.8mm (3/16") Round File bit 6.35mm (1/4") Hex shank	D-73760
φ5.2mm (13/64") Round File bit 6.35mm (1/4") Hex shank	D-73776
φ5.5mm (7/32") Round File bit 6.35mm (1/4") Hex shank	D-73782

### Flat File, Depth gauge

For all saw chain  
Depth gauge : .025" / 0.64mm



Flat file		Depth gauge	Flat file and File handle and Depth gauge
Part No.	Q'ty	Part No.	Part No.
953003060	1	953100090	-
D-67452	1	D-67474	D-70998
D-67468	12		

### File set for in Roll Up Pouch

For all saw chain



Description	Part No.
φ4.0mm Round File(3pcs) / File Holder / Flat File / Handle(2pcs) / Depth Gauge	D-72154
φ4.5mm Round File(3pcs) / File Holder / Flat File / Handle(2pcs) / Depth Gauge	D-72160
φ4.8mm Round File(3pcs) / File Holder / Flat File / Handle(2pcs) / Depth Gauge	D-72176
φ5.2mm Round File(3pcs) / File Holder / Flat File / Handle(2pcs) / Depth Gauge	D-72182
φ5.5mm Round File(3pcs) / File Holder / Flat File / Handle(2pcs) / Depth Gauge	D-72198

### File handle



Q'ty	Part No.
1	953004010
1	D-67496
50	D-67505

### Filling vise



Part No.
D-67480

### Hook holder for extension cord



Type	Description	Part No.
A	Arm band complete set	194679-8
B	Cord holder complete set	194677-2
C	Hook complete	158024-1

### Chain oil

Item			
	Chain oil  With Makita chain oil, chain oiling is formulated to adhere to the bar and chain and to reduce wear. Adhesion additive helps keep sap and pitch from clinging to the bar and chain. (Not available in Austria)	100ml	182229-1 199897-3
		1L	195093-1 988002656
		5L	988002658
		55L	988002260
		200L	988002261
	BIOTOP Chain oil  With BIOTOP, chain oiling is safe for environment. BIOTOP is purely vegetable-based and readily biodegradable. It meets the strict requirements of the RAL UZ48 environment mark for environmental compatibility, lubrication, and aging resistance.	1L	980008610
		5L	980008611
		55L	980008217
		200L	980008218

### Pruning extension set

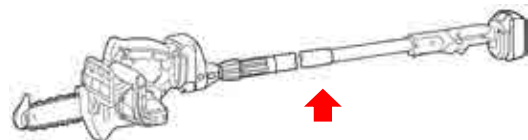

Model No.	BATTERY	Part No.
DUC122	BL1830B	195595-7

### Bar nut



\* Pole saw attachment (196315-2)

Model No.	Thread size	Wrench size	Part No.
EY401MP*	M6	10	XTM0000023

**Shear blade & Blade cover for Grass Shear**



Model No.	Cutting width	1	2	3
		Blade assembly	Blade cover	Grass Receiver
DUM168, DUM604, UM600D, UM603D	160mm	195267-4	452055-5	457426-1
DUM111 UM110D	110mm	191N23-4	459011-6	454880-0

**Conversion from Hedge Trimmer to Grass Shear**

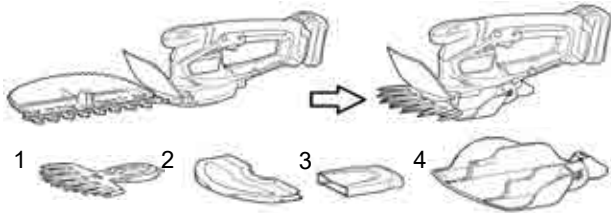

Model No.	Cutting width	1	2, 3 & 4	3
		Blade assembly	Blade cover, Grass receiver & Clank cover set	Clank cover
UH201D	160mm	195267-4	198412-0	452198-3
	110mm	191N23-4	191N25-0	

**Shear blade & Blade cover for Grass Shear**



Model No.	1		2	3
	Blade assembly	Surface treat	Blade cover	Chip receiver
UH201D	198408-1	NICKEL PLATING	458342-0	198401-5

**Conversion from Grass Shear to Hedge Trimmer**

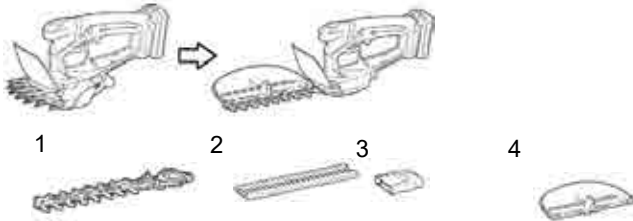

\*With clank cover

Model No.	1		2	2 & 3	4
	Blade assembly	Surface treat	Blade cover	Blade cover set	Chip receiver
DUM111 DUM110	191N24-2	BLACK OXIDE	451816-0	195274-7	198401-5
			*195274-7		
DUM604, UM600D, UM603D	198408-1	NICKEL PLATING	458342-0	195274-7	198401-5
			*195274-7		

**Shear blade & Blade cover for Hedge Trimmer**

**Blade type**

**A: Curving blade**

Optimum blade shape for smooth cutting

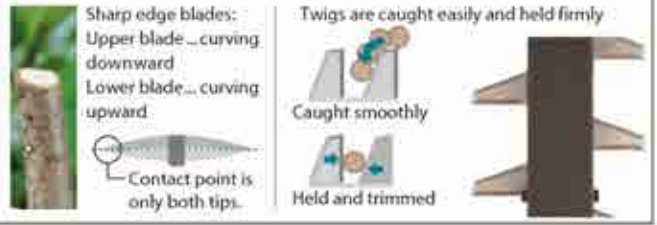

**B: High grade blade**

Upper/ Lower blade teeth with 3

sharpened edges for clean cut.



**C: Stain-free blade**

Non-electrolyzed nickel plating

Evenly and strongly adhered surface coating that features high anti-abrasion surface for long lasting coating.

Sap on the blade (after 10 hour trimming of Boxwood)



Model No.	Blade Size	Blade type	Blade assembly	Blade cover
			Part No.	Part No.

Cordless Hedge Trimmer

\*for China, Hong Kong, Korea, Malaysia, Philippines, Singapore, Taiwan & Vietnam.

\*\*for Canada & Mexico

UH201D	DUH202	200mm	C	198408-1	451816-0 458342-0
DUH551		550mm	C	194671-4 EU:196687-5	450489-6
DUH651		650mm	C	194673C0 EU:196688-3	450490-1
DUH483		480mm		195768-2	452684-4
DUH523		520mm		195769-0	452685-2
DUH501		500mm	A	191T44-2	412910-3
DUH601		600mm	A	191R53-9	412911-1
DUH751		750mm	A	191R54-7	412912-9
DUH504S		500mm	A	A-70459	459120-1
DUH604S		600mm	A	191Y03-6	459121-9
DUH754S		750mm	A	191Y05-2	459122-7
DUH502		500mm	B	191T47-6	412768-0
DUH602		600mm	B	191R57-1	412769-8
DUH752		750mm	B	191R58-9	412770-3
UH004G		600mm	A	191R53-9	412911-1
UH005G		750mm	A	191R54-7	412912-9
UH006G		600mm	B	191R55-5	412911-1
UH007G		750mm	B	191R56-3	412912-9
UH008G		600mm	B	191R57-1	459121-9
UH009G		750mm	B	191R58-9	459122-7
UH013G		600mm	A	191Y03-6	413B98-4
UH014G		750mm	A	191Y05-2	413B99-2

Model No.	Blade Size	Blade type	Blade assembly	Blade cover
			Part No.	Part No.

Pole Hedge Trimmer (Cordless, Petrol, Multi-tool attachments)

\*with Blade guard

\*\*without Blade guard

DUN461W UN460WD	460mm		191P00-8	413720-1
DUN500W	500mm		191C14-9	458413-3
DUN501W	500mm		191E73-5	459120-1
DUN600L	600mm		191C13-1	458414-1

AC Hedge Trimmer

UH4261	420mm	C	140826-9	452683-6
UH4861	480mm	C	140830-8	452684-4
UH5261	520mm	C	140827-7	452685-2
UH4570	450mm	C	194660-9	450489-6
UH5570	550mm	C	194663-3	450489-6
UH6570	650mm	C	194666-7	450490-1
UH5580	550mm	C	194671-4 EU:196687-5	450489-6
UH6580	650mm	C	194673C0 EU:196688-3	450490-1
UH7580	750mm	C	194675-6	450490-1

### Chip receiver assembly set

keeps branch or leaf debris from scattering around.  
• Attachable to either side of the blade



\*\*for Canada Mexico

Model No.	Description	Part No.
DUH202, *DUM111, *DUM604, UH201D, *UM110D, *UM600D, *UM603D	One-touch installation / removal	198401-5
DUH551 DUH651 UH4570, UH5570, UH5580, UH6570, UH6580, UH7580	One-touch installation / removal	194681-1
DUH483, DUH523, UH4261, UH4861, UH5261	With binding head screw M5X12 x 5pcs	195050-9
DUH501, DUH502, DUH601, DUH602, DUH751, DUH752	One-touch installation/removal	199151-5
DUH502, DUH602, DUH752	One-touch installation/removal	199152-3**
DUH504S, DUH604S, UH013G	Without bind head screw M5X12 (P/N:915211-3 4pics)	191D33-1
DUH754S, UH014G	Without bind head screw M5X12 (P/N:915211-3 5pics)	191D34-9
UH004G, UH006G, UH008G	One-touch installation/removal	191R51-3
UH005G, UH007G, UH009G	One-touch installation/removal	191R52-1
DUN500W, DUN501W DUN600L	One-touch installation / removal	191M40-8
DUN461W UN460WD	One-touch installation / removal	191T43-4

### Long attachment handle (Extension handle kit)



\*with grass shear blade

Model No.	Part No.
DUM604, *DUH202, UM110D, DUM111, UM600D, UM603D, *UH201D	198516-8 EU:198486-1

### Branch catcher set

Branch catcher set



Model No.	Part No.
*DUP361, *DUP362	199311-9

### Pruning Shear blade

Shear blade (U)



Shear blade (L)



Do not re-use Stop Ring E-4 when reassembling.  
Stop Ring E-4



\*With Stop Ring E-4 (P/N:961011-9)

\*\*Hex socket button head screw M3x6 P/N:266183-8 & Shoulder bolt M8 P/N:251573-8 are also necessary.

Model No.	TYPE	*Shear blade (U)	Shear blade (L)
		Part No.	Part No.
DUP361 DUP362	Standard	197748-4 EU : 197588-0*	197749-2 EU : 197367-6
	For hard branch	199168-8	199169-6
	For thin branch	199314-3**	199171-9**

### Diamond file for shear blade



Model No.	Part No.
DUP361, DUP362	794530-8

### Battery powered pruning shear others accessory



Model No.	Item	Part No.
DUP361 DUP362	Standard Harness	161377-9
	Narrow Strap Harness for Summer	161603-6
	Holster	161379-5
	Arm Band	166062-9
	Cord Holder	154511-8
	Connection Cord	661445-3

### Wheelbarrow attachment

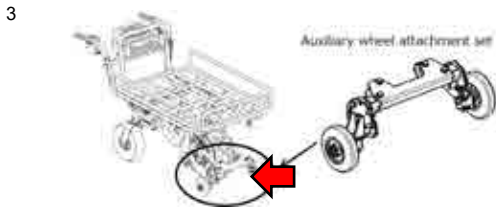

Model No.	Item	Part No.
DCU180	1 Carrier set (Pipe deck)	199116-7 EU:199009-8
	2 Bucket set	198494-2 EU:199008-0
	3 Auxiliary wheel attachment set	191A01-6

### Rotary lawn mower blade



Model No.	Size(mm)	Part No.
Cordless Lawn Mower		
DLM380	380	196863-1
DLM432	430	191D43-8
DML460, DLM461, DLM463, DLM464	460	199367-2
DLM462, DLM465	460	191D51-9
LM001J	480	191V97-3
DLM530, DLM531, DLM532, DLM533, DLM534, DLM535, DLM536, DLM537, LM001C	530	191D52-7
DLM530, DLM532, DLM533, DLM536, LM001C	530	*191W87-2
LM002J	530	191V96-5
Electric Lawn Mower		
ELM3320	330	YA00000745
ELM3720	370	YA00000746
ELM4120	410	YA00000747
ELM4121	410	YA00000738
ELM4620	460	YA00000741
ELM4621	460	YA00000741

### Rotary lawn mower swing back blade



Model No.	Swing back blade set		Replacement blade set	
	Size(mm)	Part No.	Par pkg.	Part No.
DLM462, DLM465	460	191D49-6	4	191D47-0
DLM530, DLM531, DLM532, DLM533, DLM535, DLM536, DLM537, LM001C	530	191D50-1	4	191D48-8

### Scarifier drum

Model No.		Part No.
UM3200		Scarifying 652024718
		Lawn Raking 652024719
UM3600		Scarifying 652024746
		Combination 652024750
		Lawn Raking 652024749

### Mulching plug set

Model No.	Part No.
DLM382 DLM432	191D46-2

### Earth Auger Handle set for Angle drill

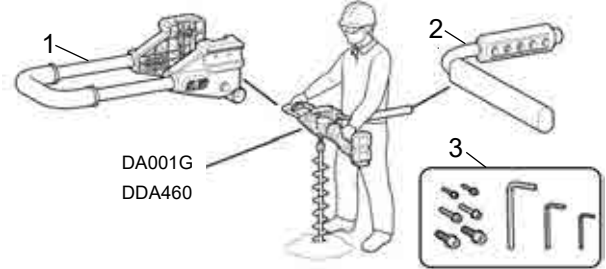

Model No.	item	Part No.
DA001G, DA002G, DDA460	1-3set	191P11-3

### Earth Auger Bit Adapter

Model No.		Part No.
DDG460, DG001G		327684-2
DA001G + 191P11-3		327685-0
DDA460 + 191P11-3		327687-6











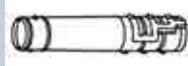

### Vacuum attachment



Model No.	No.	Description	Part No.
DUB363	1+2	Vacuum Kit Set	191P37-5
	2	Dust Bag Set	191P40-6

### Pipe, End pipe, Flat nozzle & others accessory

\*Adapter pipe 71 set are also necessary.  
 \*\*Adapter pipe 80-72 set are also necessary.  
 \*\*\*Adapter pipe 85-72 set are also necessary.  
 \*\*\*\*Adapter pipe set MG set are also necessary.

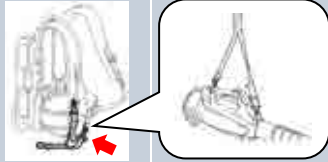
Model No.	Items	Part No.
DUB184	Front Nozzle Set 	183P96-3
DUB362	Long Nozzle Set 	183R02-0
DUB363	End Nozzle 72 Set 	183R01-2
DUB363	Pipe 90-72 Assembly Set 	183R06-2
UB001C UB001G	END NOZZLE 80 SET 	191P97-7
DUB184** DUB362 DUB363 UB001C*** UB001G*** UB400MP**** UB401MP****	Extension Nozzle 	197888-8
	Flat nozzle 	197889-6
DUB184** DUB362* DUB363 UB001C*** UB001G*** UB400MP**** UB401MP****	Gutter nozzle set (2.9m) <ul style="list-style-type: none"> <li>• Extension Pipe 72 (0.9m P/N:459816-4) x3</li> <li>• Nozzle (P/N:162790-4) x1</li> <li>• Hose Clamp 75-90 (P/N:281030-2) x2</li> <li>• Hose Clamp 85-100 (P/N:281031-0) x1</li> </ul> 	191B03-8
DUB362 DUB363	Adapter pipe 71 set 	191J13-3
DUB184	Adapter pipe 80-72 set 	191L13-5
UB001C UB001G	Adapter pipe 85-72 set 	191L96-5
UB400MP UB401MP	Adapter pipe set MG 	191C15-7
UB001G DUB184 DUB362	Shoulder belt 	166094-6
UB001C + DPC1200  UB001C + DPC01	Band Assembly set 	191J48-4

### Nozzle assembly

A:Standard equipment



Model No.	Size(mm)	Type	Part No.
UB100D, UB101D, DUB185, DUB186	220	A	123245-4
	430	-	123246-2

### Tapered nozzle set



Nozzle assembly (P/N:132025-7) is also necessary

Model No.	Color	Part No.
UB100D, UB101D, DUB185, DUB186	Gray	192236-6

### Garden Nozzle Assembly Set / Bending long nozzle set

\* long nozzle



Model No.	Part No.
UB100D, UB101D, DUB183, DUB185, DUB186	191G09-6

### Dust Bag



Model No.	Part No.
UB100D, UB101D, DUB185, DUB186	123241-2

















### Flexible hose set

(Total length: 95cm)



Model No.	Part No.
DUB185, DUB186, UB100D, UB101D	196643-5

## Power washer accessories for DHW080, HW1200, & HW1300

Shape	Models	Part No.
Trigger gun set 	DHW080 HW1200 HW1300	197842-2
Variable short gun set 	DHW080	191M52-1 (TAIWAN)
Variable nozzle set 	DHW080 HW1200 HW1300	197822-8
Vario spray lance set 	DHW080 HW1200 HW1300	191U88-8
Vario spray nozzle set 	DHW080 HW1200 HW1300	191U86-2
Extension set 	DHW080 HW1200 HW1300	191U84-4
Variospray lance set 	DHW080 HW1200 HW1300	197876-5
Cyclone jet nozzle set 	DHW080 HW1200 HW1300	197824-4
Cyclone guard set 	DHW080 HW1200 HW1300	197864-2
Under body spray lance set 	DHW080 HW1200* HW1300* (*for 110-127V) HW1200** HW1300** (**for 220V-240V)	197859-5  198909-9
Extension pipe set (0.9m / 1.3m / 1.7m) 	DHW080 HW1200 HW1300	197870-7
Rotating brush set 	DHW080 HW1200 HW1300	197831-7
Wash brush set 	DHW080 HW1200 HW1300	197828-6
Foam nozzle set 	DHW080 HW1200 HW1300	197886-2
Pipe cleaning hose 	DHW080 HW1200 HW1300	10 m 197837-5 15m 197840-6
High pressure extension hose 	DHW080 HW1200 HW1300	5m 197845-6 8m 197847-2 10m 197850-3

Shape	Models	Part No.
Twist prevention joint set 	DHW080 HW1200 HW1300	197867-6
Self-suction hose set 	DHW080 HW1200 HW1300	197873-1
Accessory joint set 	DHW080 HW1200 HW1300	197853-7
Absorption connector set 	DHW080 HW1200 HW1300	197881-2
One touch joint set 	DHW080 HW1200 HW1300	197883-8
Cleaner pin set 	DHW080 HW1200 HW1300	197879-9
Shoulder belt 	DHW080	199486-4
Trolley 	DHW080	TR00000002 (EU)TR00000001

## Grease vessel set

Description	Size		Part No.
For Pole hedge trimmer and Multi-tool attachments (Cultivator, Power brush and Power sweep) (GREASE NO.0)	80ml		197439-7
	80ml	For RUSSIA	191E22-2
For string trimmer, Brushcutter and Hedge trimmer (GREASE NO.2)	80ml		199450-5
	80ml	For RUSSIA	199456-3

## Safety goggles

Photo:  
195246-2



192219-6



Part No.

192219-6









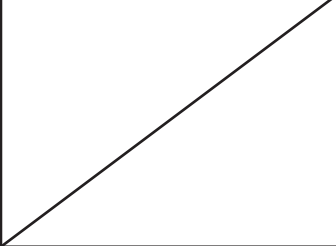

195246-2

# ACCESSORIES

## ▣ Miscellaneous



**Wrenches**

<p><b>Adjustable wrench</b></p> 		<p>Wide excursion jaw allows each tool to work with even more fastener sizes.</p>	
<p><b>Spanner</b></p>	<p><b>Open end</b></p> 		<p>U-shaped opening grips with two opposite face of the bolts and nuts. Due to the opening, it can easily access to bolts and nut.</p>
<p><b>Spanner</b></p>	<p><b>Flare end</b></p> 		<p>Narrow opening which is wide enough to fit over the tube. Large contact surface with fastener reduces rounding. Suitable for aluminum, copper and brass hexagonal fittings on oil pipe.</p>
<p><b>Spanner</b></p>	<p><b>Box end</b></p> 		<p>Enclosed opening grips snugly fits the faces of the bolts and nuts. Force can be applied to bolts or nuts with decreased chance of damaging.</p>
<p><b>Ratcheting wrench</b></p> 		<p>The ratcheting mechanism allows fastener to be tightened or loosened without disconnecting the tool from it. It makes the works more rapidly.</p>	
<p><b>Hex key wrench with ball-end</b></p> 		<p>Used for tightening or loosening cap screw and bolts with hexagonal sockets attached to their heads. A ball end allows the tool to be used at an angle off-axis to screw and bolt. It means it can used at tightening area.</p>	



**Tape measure**

**Blade type**



Makita tape measure is highly durable and convenient. When the scales are blurred or hook is lost, that would be the end of its life. This measure is for professional which has a special coated tape, hook protector and damper which absorbs shocks leads to great durability.



**Feature**

**1. Special Coating**

- \* "DURA COAT" makes 5 times more durable
- \* "SILICA COAT" makes easier note



**2. High durability of Hook**

- \* Installed damper absorbs the shock on the hook
- \* Hook protector reduces the shock on the hook
- \* Tightly fixed hook with "4rivets+protector"



**3. Convenience**

- \* 2-sided print
- \* Hook with magnet
- \* "Matte finish" makes easier to read scales
- \* Standout



**Printed size**

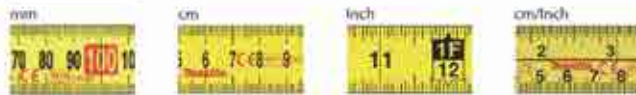

**Tape measure**



Size	Length	Width	Part No.
cm	2m	13mm	E-03078
cm/inch	2m/6ft	13mm / 1/2"	E-10590



Size	Length	Width	Part No.
cm	3.5m	16mm	B-57130



\*North America package

Size	Length	Width	Part No.
mm	5.5m	25mm	B-68507
	7.5m	25mm	B-68513
cm	5.5m	25mm	B-57146
	7.5m	25mm	B-57152
inch	18ft	1"	*B-57180
	25ft	1"	*B-57196
cm/inch	5.5m/18ft	25mm/1"	*B-57211
	7.5m/25ft	25mm/1"	*B-57227

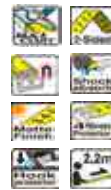

\*North America package

Size	Length	Width	Part No.
mm	10m	25mm	B-68529
cm	10m	25mm	B-57168
inch	33ft	1"	*B-57205

**Tape measure with holder & safety cord**



Size	Length	Width	Part No.
cm	7.5m	25mm	B-57174
cm/inch	7.5m/25ft	25mm/1"	B-68351

**Screw driver**



	Size	Length (mm)	Part No.
+	PH1	100	B-65903
	PH2	100	B-65919
	PH3	150	B-65931
+	PZ1	80	B-65947
	PZ2	100	B-65953
	PZ3	150	B-65969
+	T10	100	B-65975
	T15	100	B-65981
	T20	100	B-65997
	T25	100	B-66008
	T30	100	B-66014
-	SL4.0	100	B-66020
	SL5.5	100	B-66036
	SL6.5	125	B-66042
	SL8	150	B-66058

**Go thru Screw driver**

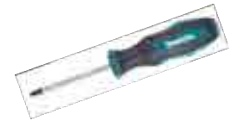

	Size	Length (mm)	Part No.
+	PH1	75	B-66064
	PH2	100	B-66070
	PH3	150	B-66086
+	PZ1	75	B-66092
	PZ2	100	B-66101
	PZ3	150	B-66117
-	SL5.5	75	E-04933
	SL6.5	150	E-04949
	SL8	200	E-04955

**Ratchet screwdriver**

With screw bit 25mm (PH2)x1pcs.



Part No.
D-58833

**Shock driver**

Makita shock driver is very useful tool which as a regular handy driver and a shock driver when you work on the stripped screw.



**How to remove**

1. While applying force in the fastening direction, hold the grip securely,

2. Apply strong impact with the hammer.



This handy driver can remove both crushed and stripped screws which could not be loosened by the electric tools. Applying the impact on the handle generates a torque in the rotation direction, so both crushed and stripped screws can be removed.



\*The impact on the handle generates 12 degrees torque in the loosening direction and even the stripped screw will be loosened.

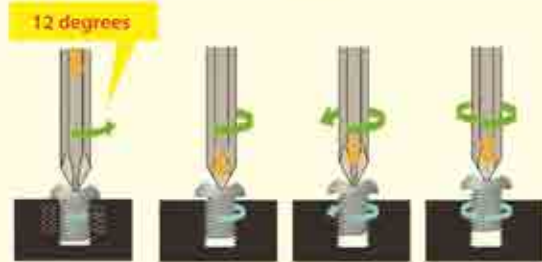

	Size	Length (mm)	Part No.
+	PH2	125	B-42438
	PH3	150	B-42444
+	PZ2	125	B-42450
	PZ3	150	B-42466

**Ratchet screw driver with screw bit 8pcs.**



Size	Part No.
PH1, PH2, PZ1, PZ2X2,T20, T30, SL5.5	E-10942
	E-10942-12

**40 pcs. Ratcheting Tap & die set**

Small/ Medium Ratcheting T wrench. Small Tap adapter, Medium Tap adapter  
 Medium Hex die adapter, Screw driver, Pitch gauge,  
 NC Hex die: 3mmx0.50, 3mmx0.60, 4mmx0.70, 4mmx0.75, 5mmx0.80, 5mmx0.90,  
 6mmx1.00, 7mmx1.00, 8mmx1.25, 9mmx1.25, 10mmx1.50, 11mmx1.50, 12mmx1.75  
 NC Plug Tap: 8mmx1.25, 9mmx1.25, 10mmx1.50, 11mmx1.50, 12mmx1.25  
 NC Taper Tap: 3mmx0.50, 3mmx0.60, 4mmx0.70, 4mmx0.75, 5mmx0.80, 5mmx0.90,  
 6mmx1.00, 7mmx1.00  
 NF Hex Die: 9mmx1.00, 10mmx1.5, 12mmx1.50  
 NF Plug Tap: 9mmx1.00, 10mmx1.25, 12mmx1.50  
 BSP Hex Die: 1/8-28, BSP Tap 1/8-28



Part No.
B-65838

**Ratcheting tap & die handle**



Part No.
B-65866

**Tap adapter**



Part No.
B-65872

**Twist lock die adapter**



Part No.
B-65888

**Ratchet & socket set**



Drive	Contents	Sum	Part No.
1/4" SQ	84T Ratchet, bit adapter, Slide T bar, Socket: 4, 4.5, 5, 5.5, 6, 7, 8, 9, 10, 11, 12, 13mm, Deep socket: 5, 6, 7, 8, 9, 10, 11, 12, 13mm, Extension bar: 3", 6", T bit: T8, T10, T15, T20, T25, T27, T30, T40x25mm	34	B-65567
3/8" SQ	84T Ratchet, adapter to 1/2" SQ, Socket: 8, 9, 10, 11, 12, 13, 14, 15, 16, 17, 18, 19, 20mm, Middle socket: 8, 10, 13, 16, 17, 19mm, Extension bar: 3", 6"	23	B-65573
1/2" SQ	84T Ratchet, Adapter to 3/8" SQ, Universal joint, Socket: 10, 11, 12, 13, 14, 15, 16, 17, 18, 19, 20, 21, 22, 23, 24, 27, 30, 32mm, Extension bar: 5", 10"	23	B-65589

**Ratchet handle**



Drive	Part No.
1/4" SQ	E-11558
3/8" SQ	E-11564
1/2" SQ	E-11570

**Pass thru socket set**



Contents	Sum	Part No.
Pass thru Socket: 10, 11, 12, 13, 14, 15, 16, 17, 18, 19mm, Socket adapter: 1/4", 3/8", Pass thru Extension bar: 75mm, Ratchet handle (Pass thru handle straight)	14	B-65595
Pass thru Socket: 10, 11, 12, 13, 14, 15, 16, 17, 18, 19mm, Pass thru Socket: 3/8", 7/16", 1/2", 9/16", 5/8", 11/16", 3/4", Socket adapter: 1/4", 3/8", Pass thru Extension bar: 75mm, Ratchet handle (Pass thru handle straight)	21	B-65604

**Pass thru extension bar**



Part No.
B-65632

**Socket adapter**



Size	Part No.
1/4"	B-65844
3/8"	B-65850

**Locking flex pass thru handle**



Part No.
B-65626

**Pass thru handle straight**



Part No.
B-65610

**Pass thru socket**



Size	Part No.	Size	Part No.	Size	Part No.
10mm	B-65648	14mm	B-65682	17mm	B-65713
11mm	B-65654	15mm	B-65698	18mm	B-65729
12mm	B-65660	16mm	B-65707	19mm	B-65735
13mm	B-65676				

**Retractable utility knife**



Part No.
B-65785

**Quick change Folding utility knife**



Part No.
B-65501

**Spare blade 10 pcc. set**

Part No.
B-65517

**Snap-off knife**



Part No.
D-58855

Part No.
D-65713

**Utility knife**



Part No.
E-11520
E-11520-12

**Combination wrench 9pcs. set**



Size	Part No.
8, 10, 12, 13, 14, 15, 16, 17, 18mm	B-65539

**Combination wrench**



Size	Part No.	Size	Part No.	Size	Part No.
8mm	E-11586	14mm	E-11623	17mm	E-11651
10mm	E-11592	15mm	E-11639	18mm	E-11667
12mm	E-11601	16mm	E-11645	19mm	E-11673
13mm	E-11617				

**Double box wrench 5pcs. set**



Size	Part No.
8x9, 10x11, 12x13, 14x15, 18x19mm	B-65551

**Flare nut wrench 5pcs. set**



Size	Part No.
9x11, 10x12, 13x14, 15x17, 16x18mm	B-65545

**Double ratchet wrench 8pcs. set**



Size	Part No.
8, 10, 12, 13, 14, 15, 17, 19mm	B-65523

**Hex key wrench 9pcs. set**



Size	Part No.
1.5, 2, 2.5, 3, 4, 5, 6, 8, 10mm	B-65894

**Box joint water pump pliers**

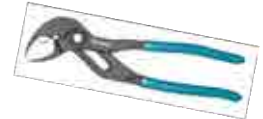

Overall length	MAX Jaw size	Part No.
7"(180mm)	37mm	B-65741
9.5"(240mm)	49mm	B-65757
12"(300mm)	68mm	B-65763

**Water pump pliers**



Overall length	MAX Jaw size	Part No.
10"(250mm)	51mm	B-65486
12"(300mm)	76mm	B-65492

**Smooth face claw hammer**



Overall length	Size	Part No.
250mm	20OZ. (0.57kg)	B-65779

**Aviation snip**



Description	Cutting capacity		Part No.
	Cold-rolled steel	Stainless steel	
Cuts straight	18ga (1.22mm)	23ga (0.61mm)	B-65791
Cuts left			B-65800
Cuts right			B-65816
Bull dog			B-65822

**Adjustable wrench**



Length	Capacity	Part No.
6"(150mm)	29mm	B-65414
8"(200mm)	36mm	B-65420
10"(250mm)	38mm	B-65436
12"(300mm)	43mm	B-65442



**11 pcs. Pass thru adjustable wrench set**



Description	Size	Part No.
Adjustable wrench	200mm	B-65458
3/8" socket	3/8"(10mm), 7/16"(11mm), 15/32"(12mm), 1/2"(13mm), 9/16"(14mm), 19/32"(15mm), 5/8"(16mm), 11/16"(17mm), 23/32"(18mm), 3/4"(19mm)	



**Locking adjustable wrench**



Size	MAX Jaw size	Part No.
10"(250mm)	35mm	B-65470

**LED Pen Light (without battery)**

Battery type: AA



Part No.
D-58752



**Grout Scraper**



Part No.
D-72914



# Strap Belt System

## System as a STRAP

Totally New on the market - unique STRAP Belt System with quick release buckles at the ends makes the belt multipurpose. Strap with comfortable soft rubber shoulder pad makes the lifting more comfortable. Fits to all Makita Tool Bags and Cases.



## System as a BELT

Strap BELT can be easily detached from any Tool Bag or Tool Case and worn on the waist as a light-duty tool belt. Strap can be adjusted, which is flexible and convenient to fit your need. Can be worn with any Makita Tool Pouch and Holder.





**Over 45 products within the system**

**E-05418**  
Ultimate Adjustable Tool Case

**E-05424**  
Reinforced Adjustable Tool Case

**E-05430**  
Ultimate Open Tool Tote

**E-05474**  
Ultimate 3-Way Universal Tool Tote

**E-05480**  
Ultimate 4-Sided Tool Tote

**E-05549**  
Ultimate Chainsaw Bag

**E-05561**  
Roll-Top All Weather Tube Bag

**E-05468**  
Ultimate Wide Mouth Tool Bag

**E-05577**  
Roll-Top All Weather Duffle Bag

**E-05452**  
Ultimate Gate Mouth Tool Bag

**E-11782**  
Ultimate Heavyweight Tool Bag

**E-05670**  
1M Guide Rail Protective Holder

**E-05664**  
1.4M / 1.5M Guide Rail Protective Holder

**E-10920**  
1.9M Guide Rail Protective Holder

**E-10936**  
3M Guide Rail Protective Holder

**E-05505**  
Technician Tool & Laptop Bag

**E-05620**  
Ultimate Lunch Bag & Belt

**E-05583**  
Ultimate Smartphone Holder

**E-12980**  
Ultimate Smartphone Holder XL

**E-05309**  
Belt Loop - 3 Pack

**E-05315**  
Belt Loop - 6 Pack

**E-05278**  
Tape Measure Holder

**E-05212**  
Ultimate 4-Way Electricians Holder

**E-05228**  
Ultimate 3-Way Hammer & Tool Holder

**E-05262**  
Knife / Secateur Holder

**E-05234**  
Side Gate Hammer & Tool Holder

**E-05240**  
Looped Hammer & Axe Holder

**E-05256**  
Universal Clip Holder

**E-05599**  
Thermal Flask & Holder

**E-05608**  
Thermal Mug & Holder

**E-05103**  
Pencil Driver Holster Universal L/R Handed

**E-05153**  
Rooter & General Purpose Pouch

**E-05147**  
Ultimate 3 Pocket Fixing Pouch

**E-05181**  
Ultimate Electricians Pouch

**E-05131**  
Ultimate 2 Pocket Fixing Pouch

**E-05094**  
Drill Holster Universal L/R Handed

**E-05206**  
Zip Top Pouch - Dual Battery or Fixings

**E-05284**  
Ultimate Chisel & Tool Holder

**E-05278**  
Tape Measure Holder

**E-05228**  
Ultimate 3-Way Hammer & Tool Holder

**E-05256**  
Universal Clip Holder

**E-05240**  
Looped Hammer & Axe Holder

**E-05599**  
Thermal Flask & Holder

**E-05608**  
Thermal Mug & Holder

**E-05103**  
Pencil Driver Holster Universal L/R Handed

**E-05153**  
Rooter & General Purpose Pouch

**E-05147**  
Ultimate 3 Pocket Fixing Pouch

**E-05181**  
Ultimate Electricians Pouch

**E-05131**  
Ultimate 2 Pocket Fixing Pouch

**E-05094**  
Drill Holster Universal L/R Handed

**E-05206**  
Zip Top Pouch - Dual Battery or Fixings

**E-05284**  
Ultimate Chisel & Tool Holder

**E-05212**  
Ultimate 4-Way Electricians Holder

**E-05228**  
Ultimate 3-Way Hammer & Tool Holder

**E-05256**  
Universal Clip Holder

**E-05240**  
Looped Hammer & Axe Holder

**E-05599**  
Thermal Flask & Holder

**E-05608**  
Thermal Mug & Holder

**E-05103**  
Pencil Driver Holster Universal L/R Handed

**E-05153**  
Rooter & General Purpose Pouch

**E-05147**  
Ultimate 3 Pocket Fixing Pouch

**E-05181**  
Ultimate Electricians Pouch

**E-05131**  
Ultimate 2 Pocket Fixing Pouch

**E-05094**  
Drill Holster Universal L/R Handed

**E-05206**  
Zip Top Pouch - Dual Battery or Fixings

**E-05284**  
Ultimate Chisel & Tool Holder

# Tool Holders 3rd Generation Technical Solutions



**Strap Belt System** with quick release buckles at the ends can be easily detached from the Tool Bags and worn on the waist as a light-duty tool belt. Fits all Tool Pouches and Holders as well as Tool Organizers.



**3L Technology** is a unique 3-layer combination of polyesters and foam that provides extra cushioning. Designed to be tough and weatherproof, these amazingly light polypropylene panels are made up of three composite layers joined securely in a desirable configuration. The innovative feature of these structured core panels means that they can be formed into any shape.



**Waterproof Bottom** is a high quality solution for tool bags – rigid, wear-resistant and waterproof it keeps tools dry and protected from damp and wet surfaces. The reinforced plastic base also helps you to keep your tool bag clean.



**Real Leather** is smooth on the outside with brushed suede on the inside. Strong and tough for a long life but soft and supple enough for lasting comfort, whilst providing excellent strength with added abrasion resistance. Heavy gauge leather has been selected for use in products requiring a thicker covering - 1.8 to 2.0mm - ensuring a top quality product.



**Durable Riveting** gives truly unbreakable strength. Strong one piece self-punching rivets with washers used in all high stress areas. Washers for greater strength in strategical places are used on one or both sides, up and down.



**Anti-Slip Solution** minimises or even avoids workplace slip and fall accidents. The high quality polypropylene tape has a rubbery surface which helps to keep you tools in place and provides additional protection to help prolong the life of your products.



**Elastic Loops** secures the contents and keeps your tools in place while carrying. It provides great flexibility for organizing your tools and accessories. Elastic Loops have been applied to a wide variety of our products to ensure that you get maximum usage from your kit. The loops are able to adapt to perfectly suit all tools and accessories.



**Side-Gate Solution** lets you easily put the tool in without looking at the holder. An additional swing feature ensures your tool is kept at a comfortable angle. Made of stainless steel for product longevity and fixed by four rivets for extra strength.



## Pouches & Holders

Descriptions	Size (mm)			Features								Picture	Part No.	
	H	L	W	TOOL RINGS	3 LAYERS	HYPERWEAVE SYSTEM	REAL LEATHER	HYPERWEAVE SYSTEM	ELASTIC LOOPS	ELASTIC LOOPS	ELASTIC LOOPS			ELASTIC LOOPS
Drill Holster Universal L/R Handed	290	170	85	✓	✓		✓	✓	✓	✓				E-05094
Pencil Driver Holster Universal L/R Handed	320	85	60	✓					✓	✓				E-05103
Impact Driver Holster Universal L/R Handed	235	155	75	✓	✓		✓	✓	✓	✓				E-05119
Universal Pouch & Drill Holster L/R Handed	270	260	145	✓	✓		✓	✓	✓	✓				E-05125
Ultimate 2 Pocket Fixing Pouch	270	260	145	✓	✓		✓	✓	✓	✓				E-05131
Ultimate 3 Pocket Fixing Pouch	270	320	145	✓	✓		✓	✓	✓	✓				E-05147
Roofer & General Purpose Pouch	270	290	145	✓	✓		✓	✓	✓	✓	✓			E-05153
3 Pouch Tool Belt Set	270	640	145		✓		✓	✓	✓	✓	✓			E-05169
Ultimate Heavyweight Tool Belt Set	310	880	170	✓	✓		✓	✓	✓	✓				E-05175
Ultimate Electricians Pouch	310	250	125	✓	✓		✓	✓	✓	✓				E-05181
Fixing Pouch & Hammer Holder	185	180	105	✓	✓		✓	✓	✓	✓				E-05197
Zip Top Pouch - Dual Battery or Fixings	185	175	105	✓	✓			✓		✓				E-05206
Ultimate 4- Way Electricians Holder	205	185	55	✓			✓	✓		✓				E-05212
Ultimate 3- Way Hammer & Tool Holder	205	185	85	✓			✓	✓		✓				E-05228
Side Gate Hammer & Tool Holder	165	110	70	✓	✓			✓		✓	✓			E-05234

Descriptions	Size (mm)			Features								Picture	Part No.
	H	L	W										
Looped Hammer & Axe Holder	165	110	65	✓	✓			✓		✓			E-05240
Universal Clip Holder	165	110	15	✓	✓			✓		✓			E-05256
Knife / Secateur Holder	200	100	50	✓	✓			✓	✓	✓			E-05262
Tape Measure Holder	165	110	80	✓	✓			✓	✓	✓			E-05278
Ultimate Chisel & Tool Holder	270	100	60	✓				✓	✓	✓			E-05284

**Belts & Braces**

Descriptions	Size (mm)			Features								Picture	Part No.
	H	L	W										
Quick Release Belt & Shoulder Strap	38	1300	-	✓									E-05290
Belt Loop - 3pcs.	129	41	-	✓									E-05309
Belt Loop - 6 pcs.													
Ultimate Padded Belt with Belt Loop	100	880	30				✓	✓					E-05321
Quick Release Belt & Belt Loop	50	1550	-										E-05337
Ultimate Leather Belt with Belt Loop	48	1380	-				✓						E-05343
Leather Belt Black M	38	1130	-				✓						E-05359
Leather Belt Black L	38	1330	-				✓						E-05365
Leather Belt Brown M	38	1130	-				✓						E-05371
Leather Belt Brown L	38	1330	-				✓						E-05387
Ultimate Padded Braces & Phone Holder	410	520	23						✓				E-05393
Ultimate Braces with Clips	-	50	-										E-05402

## Bags & Cases

Descriptions	Size (mm)			Features								Picture	Part No.
	H	L	W	TOOL ORGANISER	3 LAYERS	BUTTON	REAL LEATHER	SHOULDER RESTING	EXTENDED	ELASTIC LOOPS	SEMI-GATE SOLUTION		
Ultimate Adjustable Tool Case	310	510	300	✓		✓		✓			✓		E-05418
Reinforced Adjustable Tool Case	265	505	295	✓				✓			✓		E-05424
Ultimate Open Tool Tote	355	490	310	✓		✓		✓			✓		E-05430
Ultimate Covered Tool Tote	360	490	310	✓		✓		✓			✓		E-05446
Ultimate Gate Mouth Tool Bag	280	510	295	✓		✓					✓		E-05452
Ultimate Wide Mouth Tool Bag	250	440	240	✓							✓		E-05468
Ultimate 3-Way Universal Tool Tote	225	350	175	✓	✓				✓	✓			E-05474
Ultimate 4-Sided Tool Tote	410	260	220	✓				✓	✓	✓			E-05480
Semi-Rigid Tool Bag	270	520	250	✓	✓				✓	✓			E-05496
Technician Tool & Laptop Bag	350	425	170	✓	✓			✓		✓			E-05505
Backpack Tool Organiser	490	390	230			✓					✓		E-05511
Bucket Tote Tool Organiser	320	470	-								✓		E-05527
Tool Organiser Wrap	195	350	45						✓	✓			E-05533
Ultimate Chainsaw Bag	260	900	270	✓		✓					✓		E-05549
Roll-Top All Weather Backpack	400	330	200						✓				E-05555
Roll-Top All Weather Tube Bag	250	610	300	✓					✓				E-05561
Roll-Top All Weather Duffle Bag	600	320	320	✓					✓				E-05577

Descriptions	Size (mm)			Features								Picture	Part No.
	H	L	W	TOOL RACK	3 EXTENDS	ADJUSTABLE SYSTEM	REAL LEATHER	SHOULDER STRAPS	SLIP RESISTANT	ELASTIC LOOPS	SIDE-GATE SOLUTION		
Ultimate Heavyweight Tool Bag	260	650	330	✓									E-11782
Ultimate Heavyweight Tool Bag with Trolley	300	670	330	✓				✓					E-12712

**Gear & Equipment**

Descriptions	Size (mm)			Features								Picture	Part No.
	H	L	W	TOOL RACK	3 EXTENDS	ADJUSTABLE SYSTEM	REAL LEATHER	SHOULDER STRAPS	SLIP RESISTANT	ELASTIC LOOPS	SIDE-GATE SOLUTION		
Ultimate Smartphone Holder	165	90	40	✓	✓					✓			E-05583
Ultimate Smartphone Holder XL	200	115	40	✓	✓					✓			E-12980
Thermal Flask & Holder	200	90	85	✓	✓				✓	✓			E-05599
Thermal Mug & Holder	170	125	100	✓	✓				✓	✓			E-05608
Lunch Bag	210	330	180		✓								E-05614
Ultimate Lunch Bag & Belt	230	300	200	✓	✓	✓			✓				E-05620
Work Vest - Adjustable Pockets	640	510	-							✓			E-05636
Knee Pad Set	240	170	30										E-05642
Ultimate Knee Pad Set	240	170	95										E-05658
1.4M / 1.5M Guide Rail Protective Holder	220	1565	45	✓	✓								E-05664
1M Guide Rail Protective Holder	220	1070	45	✓	✓								E-05670
1.9M Guide Rail Protective Holder	220	1950	45	✓	✓								E-10920
3M Guide Rail Protective Holder	220	3050	45	✓	✓								E-10936

## Nails, Staples and Screws

### Wire coil Nails (Flat Type)



Dia	Length	Shank	Nails/ carton	Part No.
-----	--------	-------	------------------	----------

For Model:

AN560, AN611, AN621, AN635H, AN760, AN901, AN902, AN935H, AN953H

Dia	Length	Shank	Nails/ carton	Part No.
2.5mm (0.099")	45mm (1-3/4")	Smooth	10,800	F-30810
	50mm (2")	Screw Chisel	10,800	F-30865
		Smooth	10,800	F-31243

For Model:

AN611, AN621, AN635H, AN760, AN901, AN902, AN935H, AN953H, AN960, AN961

Dia	Length	Shank	Nails/ carton	Part No.
2.5mm (0.099")	57mm (2-1/4")	Screw Chisel	8,100	F-30878
		Smooth	8,100	F-31256
	65mm (2-1/2")	Smooth	8,100	F-30900
		Screw Chisel	8,100	F-31269

For Model:

AN560, AN611, AN621, AN635H, AN760, AN901, AN902, AN935H, AN953H

Dia	Length	Shank	Nails/ carton	Part No.
2.8mm (0.110")	50mm (2")	Smooth	9,000	F-30823
2.9mm (0.113")		Smooth	9,000	F-30849
2.9mm (0.113")	50mm (2")	Screw Chisel	9,000	F-30971

For Model:

AN611, AN621, AN635H, AN760, AN901, AN902, AN935H, AN953H, AN960, AN961

Dia	Length	Shank	Nails/ carton	Part No.
2.9mm (0.113")	57mm (2-1/4")	Screw Chisel	6,750	F-31272
		Screw Chisel	6,750	F-30881
3.1mm (0.120")	65mm (2-1/2")	Smooth	6,075	F-30836
3.3mm (0.131")		Smooth	4,050	F-30852

For Model:

AN760, AN901, AN902, AN935H, AN953H, AN960, AN961

Dia	Length	Shank	Nails/ carton	Part No.
2.9mm (0.113")	71mm (2-13/16")	Screw Chisel	6,750	F-31285
3.1mm (0.120")	75mm (3")	Smooth	4,050	F-31298
3.2mm (0.120")	75mm (3")	Screw Chisel	4,050	F-31320

For Model:

AN901, AN902, AN935H, AN953H, AN960, AN961

Dia	Length	Shank	Nails/ carton	Part No.
3.4mm (0.135")	75mm (3")	Smooth	3,600	F-31359

For Model:

AN901, AN902, AN935H, AN953H, AN960, AN961

Dia	Length	Shank	Nails/ carton	Part No.
3.1mm (0.120")	85mm (3-1/4")	Smooth	4,050	F-31304
		Screw Chisel	4,050	F-31333
3.2mm (0.120")	90mm (3-1/2")	Smooth	4,050	F-31317
3.8mm (0.146")		Screw Chisel	4,050	F-31346
		Smooth	2,700	F-31362

### Wire coil Nails (Conical Type)

For Model:

AN560, AN611, AN635H

Dia	Length	Shank	Nails/ carton	Part No.
2.1mm (0.083")	32mm (1-1/4")	smooth	21,600	F-32766
		smooth	18,000	F-32779
	38mm (1-1/2")	screw	18,000	F-32801

For Model:

AN560, AN611, AN621, AN635H, AN760, AN901, AN935H

Dia	Length	Shank	Nails/ carton	Part No.
2.1mm (0.083")	45mm (1-3/4")	smooth	18,000	F-32782
		screw	18,000	F-32814
	50mm (2")	smooth	14,400	F-32795
		screw	14,400	F-32827

### Wire coil Nails (Roofing Nail)

(7,200 pcs/box)

For Model:  
AN454



Dia	Length	Shank	Nails/ carton	Part No.
3.1mm (0.120")	22mm (7/8")	Smooth	7,200	F-30762
	25mm (1")	Smooth	7,200	F-30775
	32mm (1-1/4")	Smooth	7,200	F-30788
	38mm (1-1/2")	Smooth	7,200	F-30791
	45mm (1-3/4")	Smooth	7,200	F-30807

### Paper tape nail clipped-head

For Model:

AN943



Dia	Length	Shank	Finish	Nails/ carton	Part No.
2.9mm (0.113")	60mm (2-3/8")	Smooth	Bright	3,000	F-30566
3.1mm (0.120")	75mm (3")	Smooth	Bright	3,000	F-30579
		Smooth	Galvanized	3,000	F-30582
		Ring	Galvanized	3,000	F-30595
3.3mm (0.131")	83mm (3-1/4")	Smooth	Bright	3,000	F-30601
		Smooth	Bright	3,000	F-30614
	75mm (3")	Smooth	Galvanized	3,000	F-30627
		Smooth	Bright	3,000	F-30630
	83mm (3-1/4")	Smooth	Galvanized	3,000	F-30643
		Smooth	Bright	3,000	F-30656
3.3mm (0.131")	90mm (3-1/2")	Smooth	Galvanized	3,000	F-31645

### Pin nail



Model No.	Type	Length	Part No.
AF201Z, AF502HP, AF353, DPT351, DPT353, PT354D	23Ga(φ0.6) Pin Nail (10,000 pcs/box)	18mm (11/16")	F-31825
		25mm (1")	F-31838
		30mm (1-3/16")	F-31841
		35mm (1-3/8")	F-31854
		45mm (1-3/4")	F-32920
AF502HP		50mm (2")	F-32933
AF201Z, AF502HP, DPT351, DPT353, PT354D	23Ga(φ0.6) Stainless Pin Nail (10,000 pcs/box)	18mm (11/16")	F-32142
		25mm (1")	F-32155
AF502HP, DPT351, DPT353, PT354D		30mm (1-3/16")	F-32168
		35mm (1-3/8")	F-32171

### Finish Nail

Model No.	Type	Length	Part No.
AF601 DBN600	16 ga Finish Nail (2,000 pcs/box)	25mm (1")	F-33922
		30mm (1-3/16")	F-33935
		32mm (1-1/4")	F-33948
		35mm (1-3/8")	F-33951
		38mm (1-1/2")	F-33964
		40mm (1-9/16")	F-33977
		45mm (1-3/4")	F-33980
		50mm (2")	F-33993
		57mm (1-1/4")	F-34001
		60mm (2-3/8")	F-34014
		64mm (2-1/2")	F-34027
		AF635	15Ga Finish Nail 34deg (4,000 pcs/box)
38mm (1-1/2")	F-31973		
45mm (1-3/4")	F-31986		
50mm (2")	F-31999		
57mm (1-1/4")	F-32007		
64mm (2-1/2")	F-32010		

**Brad Nail ,**



Model No.	Type	Length	Part No.
AF506, AF552H, DBN500, DFN350, FN001G	18Ga Brad Nail (5,000 pcs/box)	15mm (5/8")	F-31867
		20mm (3/4")	F-31870
		25mm (1")	F-31883
		30mm (1-3/16")	F-31896
AF506, DBN500, DFN350, FN001G		32mm (1-1/4")	F-31902
AF506, DBN500, DFN350, FN001G		35mm (1-3/8")	F-31915
AF506, DBN500, FN001G		38mm (1-1/2")	F-31928
AF506, AF552H, DBN500, FN001G		40mm (1-9/16")	F-31931
AF506, AF552H, DBN500		45mm (1-3/4")	F-31944
		50mm (2")	F-31957
AF552H	55mm (2-3/16")	F-32946	

**Staple**



Model No.	Type	Length	Part No.
DST112 ST113D	10mm(3/8") Crown Staple (5,040 pcs/box) *Japanese package	7mm	F-81518
		10mm	F-81521
DST221	10mm(3/8") Crown Staple (5,040 pcs/box)	10mm (3/8")	F-32647
		13mm (17/32")	F-32650
		16mm (5/8")	F-32663
		19mm (3/4")	F-32676
		22mm (7/8")	F-32689
AT1150A	7/16" Medium Crown Staple 16Ga (10,000 pcs/box)	25mm (1")	F-32078
		28mm (1-1/8")	F-32081
		32mm (1-1/4")	F-32094
		35mm (1-3/8")	F-32100
		40mm (1-9/16")	F-32113
		45mm (3/4")	F-32126
AT2550A	1" Wide Crown Staple 16Ga (10,000 pcs/box)	51mm (2")	F-32139
		22mm (7/8")	F-32197
		25mm (1")	F-32023
		32mm (1-1/4")	F-32036
		38mm (1-1/2")	F-32049
	45mm (1-3/4")	F-32052	
	51mm (2")	F-32065	

**GN900 Accessories**

\* for Europe, \*\*for Australia

Description	Part No.	Part No.	Part No.
Fuel cell set	*194844-9	**194845-7	195088-4

**Concrete pin**

Includes one Fuell cell / box.  
Box : 10pins/strip x 100 = 1,000pins for Europe



Model No.	Description	Dia. (mm)	Length (mm)	Part No.
GN420C	Premium pin	3.1	15	196285-5
			17	196286-3
			22	196287-1
			27	196288-9
			32	196289-7
			20	196290-2
	Standard pin	2.6	25	196291-0
			30	196292-8
			35	196293-6
			40	196294-4

**Concrete pin**

1,000 pcs/box



Model No.	Dia. (mm)	Length (mm)	Part No.
AN250HC	2.5	19	F-33562
		22	F-33575
		25	F-33588
	3	19	F-33591

**Coil tape collated screws**

(2,000 pcs/box)



Model No.	Application	Length	Dia	Part No.
AR410HR AR411HR	Drywall to metal stad (Plasterboard to metal stad)	25mm (1")	3.5mm (0.139")	F-34072
		28mm (1-1/8")		F-34085
		41mm (1-5/8")		F-34098
	Drywall to wood (Plasterboard to wood)	25mm (1")	3.8mm (0.146")	F-34104
		28mm (1-1/8")		F-34117
		32mm (1-1/4")		F-34120
		41mm (1-5/8")		F-34133

## Flat Tape Collated Screws

50pcs screws/belt, 1,000pcs screws/box

\*Sorted by the strength for corrosion resistance

Yes

Drywall Screws

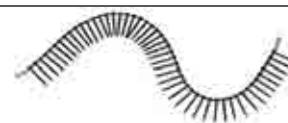

Application	L (mm)	Shank Dia (mm)	Recess	Thread	Finish	Screws /Belt	Screws /Box									Autofeed attachment set	Part No.
								DFR540	DFR550	DFR750	6842	6843	6844	6845			
								25-55mm	25-55mm	45-75mm	25-55mm	25-55mm	45-75mm	25-41mm	25-55mm		
Drywall to metal stud (Plasterboard to metal stud)	25	3.5	PH2	Fine	Phosphated	50pcs	1000pcs		Yes						Yes	F-31227	
	25	3.9	PH2	Fine	Phosphated	50pcs	1000pcs	Yes	Yes		Yes	Yes		Yes	Yes	F-30913	
	30	3.9	PH2	Fine	Phosphated	50pcs	1000pcs	Yes	Yes		Yes	Yes		Yes	Yes	F-30926	
	32	3.5	PH2	Fine	Phosphated	50pcs	1000pcs	Yes	Yes		Yes	Yes		Yes	Yes	F-31018	
	35	3.5	PH2	Fine	Phosphated	50pcs	1000pcs		Yes					Yes	Yes	F-31230	
	35	3.9	PH2	Fine	Phosphated	50pcs	1000pcs	Yes	Yes		Yes	Yes		Yes	Yes	F-31153	
	41	3.5	PH2	Fine	Phosphated	50pcs	1000pcs	Yes	Yes		Yes	Yes		Yes	Yes	F-32232	
	41	3.9	PH2	Fine	Phosphated	50pcs	1000pcs	Yes	Yes		Yes	Yes		Yes	Yes	F-31166	
	45	3.9	PH2	Fine	Phosphated	50pcs	1000pcs	Yes		Yes	Yes	Yes		Yes	Yes	F-30939	
55	3.9	PH2	Fine	Phosphated	50pcs	1000pcs	Yes	Yes	Yes	Yes	Yes		Yes	Yes	F-30942		
Drywall to Steel frame (Plasterboard to Steel frame)	35	3.5	PH2	Fine/Self Drilling	Phosphated	50pcs	1000pcs		Yes					Yes	F-31195		
Drywall to wood (Plasterboard to wood)	30	3.9	PH2	Coarse	Phosphated	50pcs	1000pcs	Yes	Yes		Yes	Yes		Yes	F-30955		
	30	3.9	PH2	Coarse	Yellow Zinc (5 micron)	50pcs	1000pcs	Yes	Yes		Yes	Yes		Yes	Yes	F-32203	
	33	3.5	PH2	Coarse	Phosphated	50pcs	1000pcs	Yes	Yes		Yes	Yes		Yes	Yes	F-31021	
	35	3.9	PH2	Coarse	Phosphated	50pcs	1000pcs	Yes	Yes		Yes	Yes		Yes	Yes	F-31179	
	41	3.5	PH2	Coarse	Phosphated	50pcs	1000pcs	Yes	Yes		Yes	Yes		Yes	Yes	F-31034	
	41	3.9	PH2	Coarse	Phosphated	50pcs	1000pcs	Yes	Yes		Yes	Yes		Yes	Yes	F-31182	
	41	3.9	PH2	Coarse	Yellow Zinc (5 micron)	50pcs	1000pcs	Yes	Yes		Yes	Yes		Yes	Yes	F-32216	
	55	3.9	PH2	Coarse	Phosphated	50pcs	1000pcs	Yes		Yes	Yes	Yes		Yes	Yes	F-31140	
Drywall to wood (Plasterboard to hard wood)	30	3.9	PH2	Hi-Low	Yellow Zinc (5 micron)	50pcs	1000pcs	Yes	Yes		Yes	Yes		Yes	Yes	F-32245	
	41	3.9	PH2	Hi-Low	Yellow Zinc (5 micron)	50pcs	1000pcs	Yes	Yes		Yes	Yes		Yes	Yes	F-32258	
	55	3.9	PH2	Hi-Low	Yellow Zinc (5 micron)	50pcs	1000pcs	Yes	Yes	Yes	Yes	Yes	Yes	Yes	Yes	F-32261	
	Chipboard Screws (Particleboard to wood)	30	4.2	PH2	Coarse, Part Thread	Yellow Zinc (5 micron)	50pcs	1000pcs	Yes	Yes		Yes	Yes		Yes	Yes	F-32528
		42	4.2	PH2	Coarse, Part Thread	Yellow Zinc (5 micron)	50pcs	1000pcs	Yes	Yes		Yes	Yes		Yes	Yes	F-32531
		55	4.2	PH2	Coarse, Part Thread	Yellow Zinc (5 micron)	50pcs	1000pcs	Yes	Yes	Yes	Yes	Yes	Yes	Yes	Yes	F-32544
	Fermacell Screws (Gypsum Fibreboard to hard wood)	30	3.9	PH2	Hi-Low	Phosphated	50pcs	1000pcs	Yes	Yes		Yes	Yes		Yes	Yes	F-31748
		45	3.9	PH2	Hi-Low	Phosphated	50pcs	1000pcs	Yes	Yes	Yes	Yes	Yes	Yes	Yes	Yes	F-31751
Hardboard Screws (HDF board to hard wood)	32	3.9	PH2	Hi-Low	Dacromate	50pcs	1000pcs	Yes	Yes		Yes	Yes		Yes	Yes	F-31793	
	41	3.9	PH2	Hi-Low	Dacromate	50pcs	1000pcs	Yes	Yes		Yes	Yes		Yes	Yes	F-31809	
Decking Screws (Wood to wood)	42	4.2	PH2	Coarse, Part Thread	Stainless Steel	50pcs	1000pcs	Yes	Yes		Yes	Yes		Yes	Yes	F-32470	
	55	4.2	PH2	Coarse, Part Thread	Stainless Steel	50pcs	1000pcs	Yes	Yes	Yes	Yes	Yes	Yes	Yes	Yes	F-32483	
Wood Screws (Playwood to hard wood)	40	4.2	PH2	Hi-Low	Zinc Plated	50pcs	1000pcs	Yes	Yes		Yes	Yes		Yes	Yes	F-31201	
	55	4.2	PH2	Hi-Low	Zinc Plated	50pcs	1000pcs	Yes	Yes	Yes	Yes	Yes	Yes	Yes	Yes	F-31214	
Wood Screws (Wood to wood)	45	4.2	SQ2	Coarse	Yellow Zinc	50pcs	1000pcs	Yes	Yes	Yes	Yes	Yes	Yes			F-33205	
	50	4.2	SQ2	Coarse	Yellow Zinc	50pcs	800pcs	Yes	Yes	Yes	Yes	Yes	Yes			F-33218	
Wood Screws (Wood to wood)	41	4.2	SQ2	Coarse	Geomet	50pcs	1000pcs	Yes	Yes		Yes	Yes		Yes	Yes	F-33276	
	45	4.2	SQ2	Coarse	Geomet	50pcs	1000pcs	Yes	Yes	Yes	Yes	Yes	Yes	Yes	Yes	F-33289	
	50	4.2	SQ2	Coarse	Geomet	50pcs	800pcs	Yes	Yes	Yes	Yes	Yes	Yes	Yes	Yes	F-33292	
	63	4.2	SQ2	Coarse	Geomet	50pcs	600pcs			Yes			Yes			F-33324	
	75	4.2	SQ2	Coarse	Geomet	50pcs	600pcs			Yes			Yes			F-33340	

## Brad Nail fuel cell set

Fuel cell/ carton x2 set



Model No.	Type	Length	Part No.	
GF600	16Ga Brad Nail Galvanized (2,000 pcs/box)	15mm	195667-8	
		19mm	195668-6	
		22mm	195669-4	
		25mm	195670-9	
		30mm	195671-7	
		32mm	195672-5	
		35mm	195673-3	
		38mm	195674-1	
		40mm	195675-9	
		45mm	195676-7	
		50mm	195677-5	
		57mm	195678-3	
		60mm	195679-1	
		64mm	195680-6	
		16Ga Brad Nail Stainless (2,000 pcs/box)	25mm	195681-4
			38mm	195682-2
	50mm		195683-0	
	64mm		195684-8	

## Side Grip / Front cover

Model No.	Item	Part No.
DUT130 DUT131		458814-5
		140G50-6
UT1305, UT2204		152892-4

## Shaft holder

Model No.	Item	Description	Part No.
DUT130 DUT131		Shaft holder 1/2-M12	458814-5
		Shaft holder 1/2-M14	140G50-6
DUT130 DUT131		1+2 Chuck 13mm + Chuck key set Capacity: 1.5-13mm Thread size: 1/2-20 UNF	196008-1
		1 Chuck 13mm Capacity: 1.5-13mm Thread size: 1/2-20 UNF	766016-2
		2 Chuck key S13	763448-4
UT1305		Shaft holder 1/2-M12	323962-8
UT2204		Shaft holder 5/8-M12	324265-3
		Shaft holder 5/8-M14	324929-9

## Hex wrench







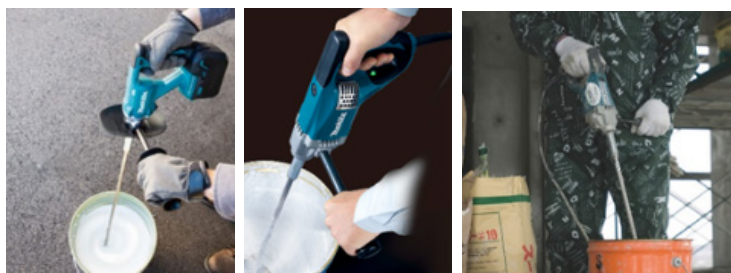



Model No.	Size	Part No.
JN1601, 2012NB	2.5mm	783208-8
JN3200, JS1600, JS1660, JS1670, 4331D, 4333D, 4334D, 4300BA, 4300BV, 4326/M, 4327/M, 4328, 4329, JV0600	3mm	783201-2
JS3200, 4350T/CT/FCT, 4351T/CT/FCT, BJV140, BJV180, 1806B, N1923B, 1911B	4mm	783202-0
KP312/S	4mm	783219-3
JS1300	5/32"	783215-1
JS8000	5/32"	783221-6



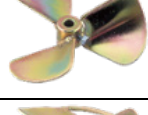

## Mixing blade



\*With Bolt & Nut M8

	Mixing Blade			Bolt		Shaft			Model
	Size	Material	Part No.	Bolt Size	Part No.	Bolt Size of Power Mixer	Size	Part No.	
	130mm	INOX	A-43670	M8 x 18	265220-5	M12	L=584mm D=12mm	168439-5	DUT130 UT1305
	135mm	Aluminum	A-43723	W5/16 x 16	265475-2	M12	L=584mm D=12mm	A-43773	DUT130 UT1305 UT2204
	150mm	INOX	*A-43686	---	---	M12	L=584mm D=12mm	168439-5	DUT130 UT1305 UT2204
	165mm	INOX	A-43692	M8 x 18	265220-5	M12	L=584mm D=12mm	168439-5	DUT130 UT1305
	175mm	Aluminum	A-43701	W5/16 x 16	265475-2	M12	L=584mm D=12mm	A-43773	UT1305 UT2204
	183mm	Aluminum	A-43739	W5/16 x 16	265475-2	M12	L=584mm D=12mm	A-43773	UT1305 UT2204
	190mm	Steel	A-33065	W5/16 x 16	265475-2	M12	L=584mm D=12mm	A-43773	UT2204
	w201mm	Steel	A-33071	W5/16 x 16	265475-2	M12	L=584mm D=12mm	A-43773	UT2204
	220mm	Aluminum	A-43717	M8 x 16	265440-1	M12	L=584mm D=12mm	A-43773	UT2204

## Mixing paddle

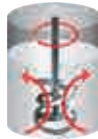
Mixing Paddle type		2 paddle for liquid	3 paddle for quick-drying liquid	2 paddle for viscous material	
Mixing Paddle image					
Feature		 Stir the material from top to bottom.	 Stir the material from top to bottom.	 Stir the material from bottom to top.	
		Used for stirring general liquid materials. Since the material is stirred from top to bottom, the material does not easily scatter even when used at high speed.	Since the material is stirred from top to bottom, the material does not easily scatter even when used at high speed. In addition, the 3-blade has high-efficient mixing capability which reduces mixing time. Therefore, it is suitable for stirring liquid materials with a short curing time.	Since the material is stirred from bottom to top, it prevents the precipitation of large gravity solids. Ex) Mortar is a mixture of cement, sand and water, so large gravity sand tends to accumulate underneath. Therefore, by stirring the sand on top, it can be mixed efficiently.	
material	liquid	Wall paints	○	○	—
		Dispersions	○	◎	—
		Glazes	◎	—	—
		Varnishes	◎	—	—
		Emulsion paint	◎	—	—
		Epoxy coating	◎	—	—
	viscous	Gypsum plaster	—	◎	—
		Glue	—	—	◎
		Cement laitance	—	—	◎
		Mortar	—	—	◎
		Plaster	—	—	◎

### Mixing paddle with 3/8inch Hex shank



Material	Diameter mm	Length mm	Shank Type	Note	Range	Sales Pkg Qty	Part No.
Liquid	120	600	Straight	Max mixing weight 15kg	★★	1	D-73536
Viscous material	120	600	Straight	Max mixing weight 20kg	★★	1	D-73542

### Mixing paddle with M14 shank



Material	Diameter mm	Length mm	Shank Type	Note	Range	Sales Pkg Qty	Part No.
Liquid	120	600	M14	Max mixing weight 15kg	★★	1	D-73508
Quick-drying liquid	120	600	M14	Max mixing weight 18kg	★★	1	D-73520
Viscous material	120	600	M14	Max mixing weight 20kg	★★	1	D-73514











# Makita - A Global Brand

Makita have established directly operated business bases in about 50 countries around the world, and have upgraded our sales network in over 170 countries and after-sales service capabilities to become one of the leading companies in our industry. In addition, Makita is producing power tools and OPE in China, Romania, Thailand, U.K., Brazil, U.S. and Germany. Currently, about 90% of our group's manufacturing work in terms of production volume is carried out overseas.

Makita's worldwide sales and service network, as well as the stable, high production quality ensured at its plants worldwide, are the embodiment of the Makita brand.

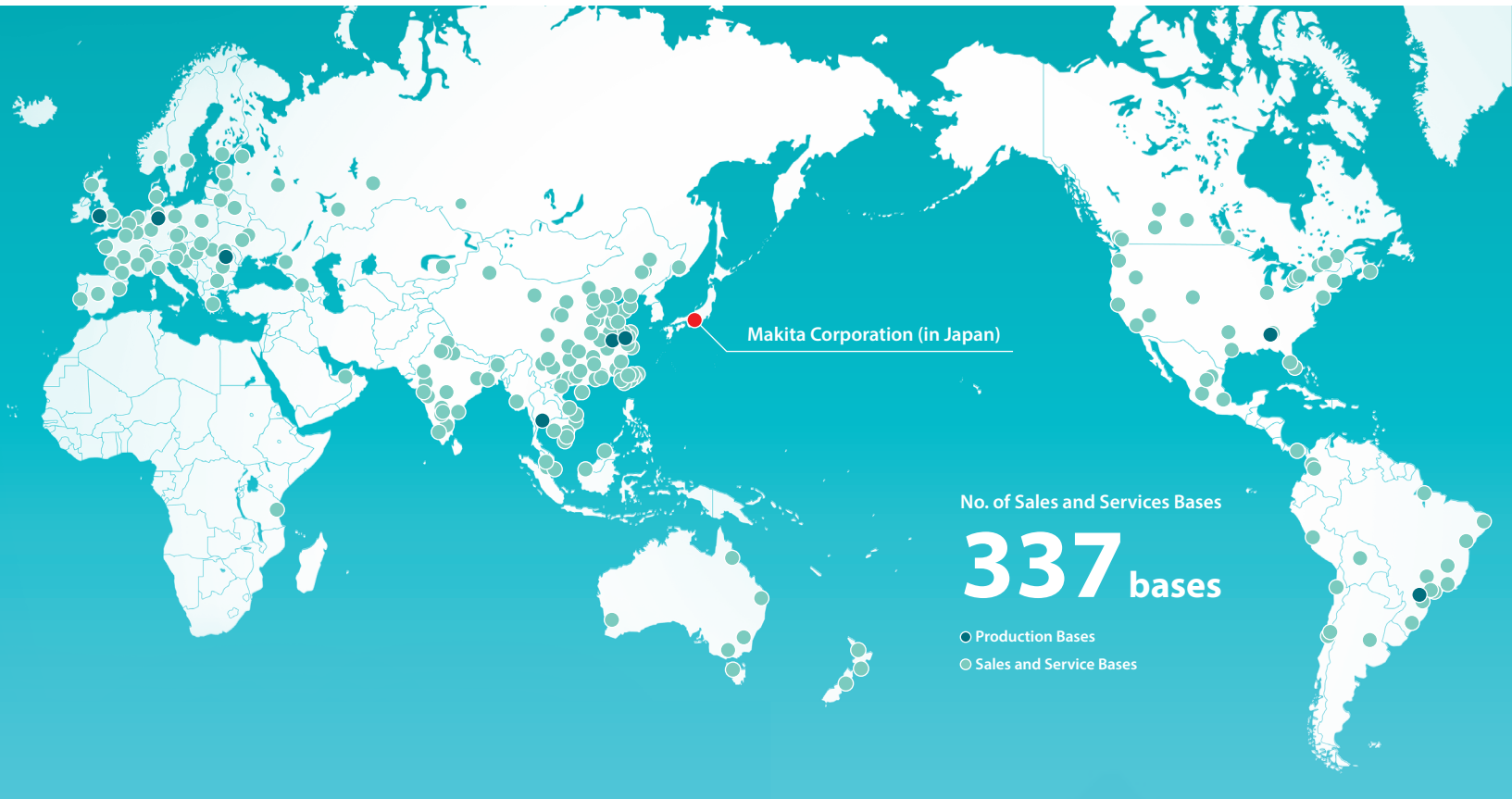

## JAPAN

Makita Corporation Headquarters



## JAPAN

Okazaki Plant



## U.S.A.

U.S. Plant



## UNITED KINGDOM

U.K. Plant



## ROMANIA

Romania Plant



## GERMANY

Germany Plant



## BRAZIL

Brazil Plant



## CHINA

China Plant (MCC)



## CHINA

China Plant (MKC)



## THAILAND

Thailand Plant



**JAPAN****Makita Corporation****Head office**

3-11-8, Sumiyoshi-cho, Anjo, Aichi  
446-8502  
Phone: +81-(0)566-98-1711  
Fax: +81-(0)566-98-6021  
www.makita.co.jp

**Okazaki plant**

22-1, Watarijima, Nemunoki-cho,  
Okazaki, Aichi 444-0232  
Phone: +81-(0)564-43-3111

**Nisshin Office**

349 Minamiyama,  
Komenoki-cho, Nisshin,  
Aichi 470-0111  
Phone: +81-(0)561-75-1500

**Tokyo branch office**

3-5-3, Hongo, Bunkyo-ku,  
Tokyo 113-0033  
Phone: +81-(0)3-3816-1141  
Fax: +81-(0)3-3813-1633

**Nagoya branch office**

2-33, Namiki, Nakamura-ku,  
Nagoya 453-0856  
Phone: +81-(0)52-419-0561  
Fax: +81-(0)52-413-0081

**Osaka branch office**

1-26-8, Tenma, Kita-ku,  
Osaka 530-0043  
Phone: +81-(0)6-6351-8771  
Fax: +81-(0)6-6352-4607

**Domestic sales offices**

Sapporo, Sendai, Niigata, Utsunomiya,  
Saitama, Chiba, Yokohama, Shizuoka,  
Gifu, Kanazawa, Kyoto, Hyogo,  
Hiroshima, Takamatsu, Fukuoka,  
Kumamoto and other major cities

**CHINA****Makita (China) Co., Ltd.****Head office & plant (MCC)**

No.1388 Middle Huangpujiang Road,  
Kunshan Economic & Technical  
Development Zone, Jiangsu, China.  
Postcode:215335  
Phone: +86-(0)512-57707710  
Fax: +86-(0)512-57713623  
www.makita.com.cn

**Domestic sales department****(MCS/MCCF)**

No.318, South Wusongjiang  
Road, Kunshan City, Jiangsu, China  
Phone: +86-(0)512-57037500  
Fax: +86-(0)512-57037118  
www.makita.com.cn

**Guangzhou sales branch (CGZ)**

Rome 1001 1002, The First Floor, Jinhao  
Building, No.38, Middle Of Huadi  
Avenue, Li Wan  
District, Guangzhou, Guangdong,  
P.R.China  
Phone: +86-(0)20-87518872  
Fax: +86-(0)20-87518873

**Shanghai sales branch (CSH)**

Room.102&103, 1F, No.128, East Luoxiu  
Road, Xuhui District, Shanghai, P.R.China  
Phone: +86-(0)21-54487198  
Fax: +86-(0)21-62476732

**Tianjin sales branch (CTJ)**

No.3 Office Building, No.23, Quanwang  
Road, Wuying Development  
Area, Tianjin, P.R.China  
Phone: +86-(0)22-29395799  
Fax: +86-(0)22-29395769

**Chengdu sales branch (CCD)**

2F, Building 1, Hatchery Building, No.9, Wu  
Ke Dong San Road, Wu Hou  
District, Chengdu, Sichuan, P.R. China  
Phone: +86-(0)28-85366002  
Fax: +86-(0)28-87337018

**Shenyang sales branch (CSY)**

No.2,10A, No.7 Street, Economic and  
Technological Development Zone,  
Shenyang, Liaoning, P.R. CHINA  
Postcode: 110141  
Phone: +86-(0)24-22530648  
Fax: +86-(0)24-22530170

**Xian sales branch (CXA)**

1 & 2F, Xian Youzhi Science and  
Technology Industrial Park NO.75  
Mingguang Road, Economic And  
Technological Development Zone, Xian,  
Shanxi. P.R. CHINA  
Postcode:710018  
Phone: +86-(0)29-86223736  
Fax: +86-(0)29-86229230Z

**Changsha sales branch (CCS)**

(Near Gaosheng Road)  
No.3, Building 5, Youxin Mechanical And  
Electrical Market, Yuhua District,  
Changsha, Hunan, P.R.China  
Phone: +86-(0)731-8526-7792  
Fax: +86-(0)731-8526-7791

**Shijiazhuang sales branch (CSJ)**

No.15, F District, Wanlian International  
Mechanical And Electrical City, No.560,  
Heping East Road, Changan  
District, Shijiazhuang, Hebei, P.R. CHINA  
Postcode: 050000  
Phone: +86-(0)311-89864089  
Fax: +86-(0)311-85024612

**Makita (Kunshan) Co. Ltd.**

No.1, Nanzi Road, Kunshan Economic &  
Technical Development Zone,  
Jiangsu, China  
Phone: +86-(0)512-57367367  
Fax: +86-(0)512-57365575

**Makita Power Tools (HK) Ltd.****Head office**

Unit 1, 17/F., Grandtech Centre,  
8 On Ping Street, Shatin, N.T., Hong Kong  
Phone: +852-2648-8683  
Fax: +852-2648-5237

**Macau Service Centre**

Em Macau, Rua Do Volong N°11,  
Rês-Do-Chão A  
Phone: +853-2835-4587  
Fax: +853-2835-4135  
www.makita.com.hk

**Makita (Taiwan) Ltd.****Head office**

No.798, Sec. 2, Wenhua 3rd Rd.,  
Linkou Dist., New Taipei City 24459,  
Taiwan  
Phone: +886-(0)2-8601-9898  
Fax: +886-(0)2-8601-2266  
www.makita.com.tw

**Taichung sales branch**

No. 839, Section 3, Zhongqing Rd, Daya  
Dist, Taichung City, 428, Taiwan  
Phone: +886-(0)4-2392-1650  
Fax: +886-(0)4-2392-1653

**Kaohsiung sales branch**

No.105, Yucheng Rd., Sanmin Dist.,  
Kaohsiung City 807, Taiwan  
Phone: +886-(0)7-343-0292~4  
Fax: +886-(0)7-341-3602

**Yilan factory service center**

No. 237, Section 3, Chuanyi Rd, Luodong  
Township, Yilan County, 265, Taiwan  
Phone: +886-(0)3-956-7801  
Fax: +886-(0)3-956-7877

**Hualien factory service center**

No.247, Sec.2, Zhongyang Rd.,  
Ji'an Township, Hualien County 973,  
Taiwan  
Phone: +886-(0)3-852-8901  
Fax: +886-(0)3-852-8515

**Yunlin factory service center**

No.197, Guangfu Rd.,  
Huwei Township, Yunlin County 632,  
Taiwan  
Phone: +886-(0)5-632-8200  
Fax: +886-(0)5-632-8190

**Tainan factory service center**

No. 182, Minzhi Rd, Xinying District,  
Tainan City 730, Taiwan  
Phone: +886-(0)6-656-5651  
Fax: +886-(0)6-656-7800

**Pingtung factory service center**

No.12&16, Ruimin Rd.,  
Pingtung City 900, Taiwan  
Phone: +886-(0)8-722-0001  
Fax: +886-(0)8-722-0733

**Taitung factory service center**

No. 51, Section 2, Zhongxing Rd, Taitung  
City, Taitung County 950, Taiwan  
Phone: +886-(0)89-232-301  
Fax: +886-(0)89-232-322

**SINGAPORE****Makita Singapore Pte. Ltd.****Head Office**

7, Changi South Street 3, Singapore 486348  
Phone: +65-6546-8700  
Fax: +65-6546-8711  
www.makita.com.sg

**Myanmar Service Center**

No. D36/2, Lan Thit Road, Nant Thar Ghone  
District, Insein Township, Yangon  
Phone: +95-(0)9-76232-6433  
+95-(0)9-76911-5388

**Cambodia Service Center**

No.432, St.271,  
Sangkat Tumnap Teuk,  
Khan Chamkarmon, Phnom Penh  
Phone: +855-(0)23-994-071  
+855-(0)78-994-071/2  
https://www.makita.com.kh/

**INDIA****Makita Power Tools India Pvt. Ltd.****Head Office**

Unit 2, Sy. No. 93/3 & 93/4,  
Koralur Village, Kasaba Hobli,  
Hoskote Taluk, Bangalore – 560067.  
India.  
Phone: +91-(0)80-2205-8200  
Fax: +91-(0)80-2854-9007  
www.makita.in

**Delhi Branch**

Khasra No. 1035, Village Mundka, Near  
Ganpati Dharam Kanta, Delhi – 110041,  
India  
Phone: 011-28341102

**Chennai Branch**

No.30, Koyambedu,  
Chennai – 600107, India.  
Phone: +91-(0)44-2479-2522  
Fax: +91-(0)44-2479-2533

**Kolkata Branch**

P-46, Hide Road Extension,  
Kolkata – 700088.  
West Bengal, India.  
Phone: +91-(0)33-2439-1030 / 1060

**Bangalore Service Centre**

Sowbhagya M Gopi Nilaya No. 66,  
Mission Road, 2nd Main, Sudhamanagar,  
Bangalore – 560027, India.  
Phone: +91-80-2222-8200

**Cochin Branch**

Door No. XVI/443A, Jubilee Road, Kerala  
– 682040, India  
Phone: +91-8590432003

**Mumbai Service Centre**

Shop No. 11, Ground Floor, Satellite  
Silver, Opp. Star Plus, Marol Naka,  
Andheri-Kurla Road, Andheri (E),  
Mumbai – 400059, India.  
Phone: +91(0)22-4974-4092

**Ahmedabad Service Centre**

Aniket Estate, Near Sawan Hotel, Near  
Sarkhej – Sanand Chokdi, S. G. Highway,  
Ahmedabad – 382210, India.  
Phone: +91-6358737996

**Hyderabad Service Centre**

3-3-10, Kings Way, Rashtra Pathi Road,  
Secunderabad – 500003, India.  
Phone: +91(0)040-4003-8000

**Peenya Service Centre**

No. 36/B, F1, 2nd Phase, 1st Main Road,  
KIADB, NTTFCircle, Peenya Industrial  
Area, Bangalore - 560058  
Phone: +91-9606980302

**Chawari Bazar Service Centre**

Shop No. 4782, Bazar Ajmeri Gate, Hauz  
Qazi, Delhi - 110006  
Phone: - 011-49145416

**Pune Service Centre**

Shop No. 104, First Floor, Plot No.  
PAP/J/121/122, J Block, MIDC Bhoasari,  
Pimpri Chinch Wad, Pune - 411026  
Phone: 020-46300061

**Rudrapur Service Centre**

MIG-48, Ground Floor, Ward No. 19, New  
Ward no. 38, Near Siddhu Palace, Awas  
Vikas, Rudrapur, Uttarakhand - 263153  
Phone: +91 7042597756

**Trichy Service Centre**

NO.415, No.S1/17A, EGA PLAZA, Trichy  
Tanjore Main Road, Thuvakudi, Tiruchy -  
620015  
Phone: +91 9600291989

**Jamshedpur Service Centre**

Shop no. 24, Shivanranjani Complex, Plot  
no. ST-8, Mouzadinli, Adityapur,  
P.S.Adityapur Ward no. 5, Saraikel (D),  
Kharswan, Jharkhand State  
Phone: +91 9830137136

**Indore Service Centre**

Unit No. B-34, Block No. B-18, Access B,  
New Siyaganj, Poddar Plaza, HTL, Unit 2,  
VIP Route No.1, Kachhi Mohalla, Indore  
Phone: 0731-3593608

**Vadodara Service Centre**

Shop No. 3, Lakod Complex, GIDC,  
Makarapura, Vadodara, Gujarat  
Phone: Mob. +91 88665 53756

**VIETNAM****Makita Vietnam Co. Ltd.****Head office**

Unit 4-5-6, Block 16 L1-L2, Street 3,  
VSP II Industrial Park, Hoa Phu Ward,  
Thu Dau Mot City, Binh Duong Province,  
Vietnam.  
Phone: +84-274-362-8338  
Fax: +84-274-362-8339  
www.makita.com.vn

**North Branch**

Unit 05, No.01, Street 6, VSP Bac Ninh  
Integrated Township and Industrial  
Park, Phu Chan Ward, Tu Son Town, Bac  
Ninh Province, Vietnam  
Phone: +84-222-376-5942  
Fax: +84-222-376-5941

**Da Nang Service Centre**

102 Trieu Nu Vuong Street, Hai Chau 1  
Ward, Hai Chau District, Da Nang City,  
Vietnam.  
Phone: +84-236-352-5079  
Fax: +84-236-352-5479

**Can Tho Service Center**

366 Vo Van Kiet Street, 5 Zone, An Thoi  
Ward, Binh Thuy District, Can Tho City,  
Vietnam.

Phone: +84-292-389-4358

Fax: +84-292-389-4359

**Buon Ma Thuot Service Center**

68 Le Duc Tho, Thang Loi Ward, Buon Ma  
Thuot City, Dak Lak Province, Vietnam  
Phone: +84-262-355-4556  
Fax: +84-262-355-4557

**Hai Phong Service Center**

No. 01 Lot OH-01, Huy Hoang Riverside  
project, Thuong Ly Ward, Hong Bang  
District, Hai Phong City, Viet Nam  
Phone: +84-225-883-1429/1529

## ASIA

### **Nha Trang Service Center**

1053 Hai Thang Tu Street, Van Thanh Ward, Nha Trang City, Khanh Hoa Province, Viet Nam  
Phone: +84-258-382-3338

### **Ho Chi Minh Service Center**

12 Trinh Van Can, Cau Ong Lanh Ward, 1 District, Ho Chi Minh City, Viet Nam  
Phone: +84-283-821-5191

### **Ha Noi Service Center**

Group 15 and No. 4, Alley 63, Truong Chinh Street, Phuong Liet Ward, Thanh Xuan District, Hanoi City, Viet Nam  
Phone: +84-243-202-2585

## THAILAND

### **Makita Manufacturing (Thailand) Co., Ltd.**

219/1 Moo 6, Tambol Bowin, Amphur Sriracha, Chonburi, 20230  
Phone: +66-3300-4750  
Fax: +66-3300-4747

## MALAYSIA

### **Makita Power Tools (Malaysia) Sdn. Bhd.**

#### **Head Office**

Lot 824, Jalan Subang 5, Subang Industrial Area, 47500 Subang Jaya, Selangor, Malaysia  
Phone: +60-(0)3-8023-0824  
Fax: +60-(0)3-8022-1448

### **Johor(Johor Bahru) Service Center**

No. 12 & 14, Jalan Rosmerah 2/9, Taman Johor Jaya, 81100 Johor Bahru, Johor  
Phone: +60-(0)7-364-9406  
Fax: +60-(0)7-364-9407

### **Sarawak(Kuching) Service Center**

Lot 1227, Lorong Demak Indah 2A, Demak Laut Industrial Area, Phase 2A, 93050 Kuching Sarawak, Malaysia.  
Phone: +60-(0)82-496-800  
Fax: +60(0)82-496-900

### **Sabah(Kota Kinabalu) Service Center**

Lot 19, Jalan Buah Duku, Kolombong Light Industrial Estate, Off Kolombong, Kolombong Zone 1, 88450 Inanam, Kota Kinabalu, Sabah  
Phone: +60-(0)88-388-278  
Fax: +60-(0)88-388 279

## AMERICAS

## UNITED STATES

### **Makita U.S.A. Inc.**

#### **Corporate office**

14930 Northam Street, La Mirada, CA 90638-5753, USA  
Phone: +1-714-522-8088  
Fax: +1-714-522-8133  
www.makitatools.com

#### **Western regional (Los Angeles) office**

14930 Northam Street, La Mirada, CA 90638-5753  
Phone: +1-714-522-8088  
Fax: +1-714-297-1544

#### **(Western) office**

10200 Military Rd, Reno, NV, 89506  
Phone: +1-775-437-9362

#### **Central regional (Chicago) office**

1450 Feehanville Drive, Mount Prospect, IL 60056-6011  
Phone: +1-847-297-3100  
Fax: +1-847-297-1544

#### **Eastern regional (Atlanta) office**

4200 Falcon Parkway Flowerly Branch, GA 30542  
Phone: +1-770-476-8911  
Fax: 866-521-3541 Free Dial USA only

#### **Southern regional (Dallas) office**

910 E. Pleasant Run Road, Wilmer, TX 75172  
Phone: +1-972-441-8099  
Fax: +1-855-231-0468

#### **Factory service centers**

Atlanta, Boston, Chicago, Dallas, Denver, Florida, Houston, Las Vegas, Los Angeles, New Jersey, Portland, San Francisco, Reno

### **Makita Corporation of America**

2650 Buford Highway, Buford, GA 30518-6045  
Phone: +1-770-932-2901  
Fax: +1-770-932-2905

### **Makita Latin America Inc.**

#### **Head office**

10801 NW 97th Street #13 Medley, FL USA 33178  
Phone: +1-305-882-0522  
Fax: +1-305-882-0484  
www.makitalatinamerica.com

#### **Panama Branch**

Local Comercial No.4, Albrook Office Center, calle Diego Dominguez, Albrook, Panama City, Panama  
Phone: +507-315-0305  
Fax: +507-315-0651

## CANADA

### **Makita Canada Inc.**

#### **Head office**

1950 Forbes Street, Whitby, ON L1N 7B7  
Phone: +1-905-571-2200  
Fax: +1-905-433-4779  
www.makita.ca

#### **Western regional office**

11771 Hammersmith Way, Richmond, BC V7A 5H6  
Phone: +1-604-272-3104  
Fax: +1-604-272-5416

#### **Factory service centers**

Burnaby(Vancouver), Calgary, Dartmouth(Halifax), Edmonton, Les Saules(Quebec City), London, Mississauga(Toronto), Nepean(Ottawa), Richmond(Vancouver), Saskatoon, St. Leonard(Montreal), Whitby, Winnipeg

## MEXICO

### **Makita México, S.A. de C.V.**

#### **Head office**

Camino Viejo A San Lorenzo Tepaltitlan (Jose Marti) No.227 Col. Tlacopa, Toluca, Estado De Mexico, C.P. 50010  
Phone: +52-722-385-8800 / 237-3293  
www.makita.com.mx

#### **Mexico city factory service center**

Norte 35 #780-C Col. Industrial Vallejo, Del. Azcapotzalco Mexico, D.F. Mexico C.P. 02300  
Phone: +52-55-5567-3387 / 5368-2937

#### **Guadalajara factory service center**

AV.Sierra Mazamitla #5864 Col.Pinar De La Calma Zapopan, Jalisco C.P. 45080  
Phone: +52-33-3632-8032 / 3632-8057

#### **Monterrey factory service center**

Avenida Pablo Livas #4207 Colonia Guadalupe victoria, Municipio Guadalupe nuevo León, C.P.67180  
Phone: +52-81-8372-4205 / 8372-4193

## BRAZIL

### **Makita do Brasil Ferramentas Elétricas Ltda.**

#### **Head office & plant**

Rodovia BR 376, Km 506,1 - (pista norte) Bairro Colônia Dona Luíza, CEP 84043-450 - Ponta Grossa, PR  
Phone: +55-(0)42-3302-2100  
Fax: +55-(0)42-3302-2120  
www.makita.com.br

#### **São Paulo sales office (MBR)**

Rua Makita Brasil, 200 -Bairro Cooperativa - São Bernardo do Campo - SP CEP 09852-080  
Phone: +55-(0)11-4392-2411 / 2199-2500  
Fax: +55-(0)11-4392-2471

#### **Bahia sales branch**

Rua Itagi, 491 - Bairro Pitangueiras - Lauro de Freitas, BA CEP: 42701-370  
Phone: +55-(0)71-3252-0154

#### **Critiba service center**

Rua Comendador Roseira, 499 Bairro Prado Velho, Curitiba, PR CEP 80215-210  
Phone: +55-(0)41-3333-8070

#### **São Paulo service center**

Rua Luis Gois, 111 Bairro Mirandópolis, São Paulo, SP CEP 04043-250  
Phone: +55-(0)11-5594-3900

#### **Rio de Janeiro service center**

Av. Das Américas, 2250 - Loja J/K - Barra da Tijuca - Rio de Janeiro, RJ CEP:22640-101  
Phone: +55-(0)21-3151-7933

#### **Recife service center**

Av. Marechal Mascarenhas de Moraes, 630, Bairro Imbiribeira, Recife, PE CEP 51170-000  
Phone: +55-(0)81-3428-0210

#### **Belo Horizonte service center**

Rua Juiz de Fora, 95 - Bairro Barro Preto, Belo Horizonte, MG CEP 30180-060  
Phone: +55-(0)31-2531-2017

#### **Pará Sales Branch**

Rodovia BR 316, Km 04 Loja 04-Bairro Águas Lindas, Ananindeua / PA CEP 67020-000  
Phone: +55-(0)91-3237-7186

#### **Porto Alegre service center**

Av. Sertorio , 5539 - JD. Lindoia - Porto Alegre - RS CEP: 91050-371  
Phone: +55-(0)51-3344-1464

#### **Guaxupé service center**

Av. Paulo Ribeiro do Valê, 1539 - Japy, Guaxupe - MG, CEP 37800-000  
Phone: +55-(0)35-3551-2825

## ARGENTINA

### **Makita Herramientas Eléctricas de Argentina S.A.**

LISANDRO DE LA TORRE 1246, PARQUE INDUSTRIAL PILARICA, FATIMA, PILAR PROVINCIA DE BUENOS AIRES, CP1629  
Phone: +54 (230)444-1100  
Fax: +54 (230)444-1105  
www.makita.com.ar

## CHILE

### **Makita Chile Comercial Ltda.**

#### **Head Office**

AV.EL PARQUE 1307,PARQUE 5,MODULO 12, SECTOR ENEA PONIENTE PUDAHUEL, SANTIAGO,CHILE CP9031244  
Phone: +56-2-2540-0400  
www.makita.cl

#### **Temuco factory service center**

Av. Pedro de Valdivia #0524 , Local 13 y 14, Temuco  
Phone: +56-2-2540-0460

#### **Antofagasta factory service center**

Pedro Aguirre Cerda 6259, local 3, Antofagasta  
Phone: +56-2-2540-0470

## PERU

### **Makita Peru S.A.**

Panamericana Sur - Km. 29, Distrito de Lurin, Provincia de Lima Centro de Operaciones "MEGACENTRO LURIN" Locales B1, B23, B24  
Phone: +51-(1)-713-1212  
www.makita.pe

#### **Bolivia Branch**

Av. Japón Nro. 3340 (3er. Anillo externo) entre Av. Alemana y Mutualista  
Phone: +59-(1)-3347-1147

## COLOMBIA

### **MAKITA COLOMBIA S.A.S**

#### **Head Office**

Bodega 3 Lote 123, Centro Empresarial Celta Trade Park, Kilometro 7 Autopista Bogotá-Medellín Funza, Cundinamarca, Colombia  
Phone: +57-601-742-9245  
www.makita.com.co

#### **Paloquemao factory service center**

Carrera 22#18-63, Bogota, Cundinamarca, Colombia  
Phone: +57-601-742-9245 EXT.532

# EUROPE

## UNITED KINGDOM

### Makita (U.K.) Ltd.

#### Head office

Michigan Drive, Tongwell, Milton Keynes, Bucks MK15 8JD  
Phone: +44-(0)1908-211678  
Fax: +44-(0)1908-211400  
www.makitauk.com

#### Wigan Warehouse

Challenge Way, Martland Park, Wigan, WN5 0LD

#### Scotland factory service center

Unit 4A, Albion Trading Estate, 750 South Street, Glasgow, G14 0SY  
Phone: +44-(0)141-9545861

#### London factory service center

V5 Vector Park, Forest Road, Feltham, Middlesex, TW13 7EJ  
Phone: +44-(0)20-88900586

### Makita Manufacturing Europe Ltd.

Hortonwood 7, Telford, Shropshire TF1 7YX  
Phone: +44-(0)1952-677688  
Fax: +44-(0)1952-677678

## FRANCE

### Makita France SAS

#### Head office

37, avenue Graham Bell, ZAC Léonard de Vinci, Bussy Saint-Georges, 77607 Marne-la-Vallée Cedex 3  
Phone: +33-(0)1-6094-6400  
Fax: +33-(0)1-6094-6380  
www.makita.fr

#### Nantes office

Le Pan Loup, 44220 Couérou  
Phone: +33-(0)2-5177-8977  
Fax: +33-(0)2-4063-8376

#### Bordeaux office

137, Rue de la Croix-de-Monjous, 33170 Gradignan  
Phone: +33-(0)5-5796-5270  
Fax: +33-(0)5-5796-5275

#### Nord office

Village d'Entreprises, 51, Rue Trémière, 59650 Villeneuve d'Ascq  
Phone: +33-(0)3-2059-7020  
Fax: +33-(0)3-2047-2220

#### Dijon office

5, Rue Edmond Voisenet, 21000 Dijon  
Phone: +33-(0)3-8054-0880  
Fax: +33-(0)3-8054-0881

#### Lyon office

29 rue Antoine Condorcet, 38090 Villefontaine  
Phone: +33-(0)7-8563-8049  
Fax: +33-(0)1-60-94-63-86

#### Toulouse office

15, Rue de Boudeville, Z.I. de Thibaud, 31104 Toulouse  
Phone: +33-(0)5-6143-2200  
Fax: +33-(0)5-6143-2201

## SPAIN

### Makita, S.A.

#### Head office

C/ Juan de la Cierva, 7-15, 28823 Coslada (Madrid)  
Phone: +34-91-671-1262  
Fax: +34-91-671-8293  
www.makita.es

#### Barcelona Office

Sector ind. La Post c/ Barcelona 3-5 08850 Gavà(Barcelona)  
Phone: +34-935-669-124

## PORTUGAL

### Makita - Ferramentas Electricas, Sociedade Unipessoal, Lda.

#### portugal sales division

Centro empresarial de Alverca, Vale das Ervas, Armazém C2 2615-187 Alverca do Ribatejo  
Phone: +351-219-936-750  
Fax: +351-219-574-982  
www.makita.pt

## ITALY

### Makita S.p.A.

Via Don Luigi Sturzo 56/58, Arluno, 20004, Milano, Italy  
Phone: +39-0331-524111  
Fax: +39-0331-420285  
www.makita.itz

## GREECE

### Makita Hellas S.A.

Tatouliou 34, Acharnes, ATTIKI PC13677  
Phone: +30-210-8071241  
Fax: +30-210-8072245  
www.makita.gr

## FINLAND

### Makita Oy

Tellimäki 4 FIN-01530 Vantaa, Finland  
Phone: +358-(0)9-857-880  
Fax: +358-(0)9-857-88211  
www.makita.fi

#### FSC

Krouvintie 5 90400 Oulu, Finland  
Phone: +358 (0)8 -237-48930

## ESTONIA

### Makita Oy Estonian Branch

#### Estonian office

Piirimäe 13, 76406 Saku vald, Harjumaa maakond  
Phone: +372-6-510-380  
Fax: +372-6-510-399  
www.makita.ee

## LATVIAN

### Makita OY Latvian Branch

#### Latvian factory service center

Vienības gatve 153/1, Mārupes Mārupes nov., LV-2167, LATVIA  
Phone: +371 67969563  
Fax: +371 6796 9564  
www.makita.lv

## LITHUANIAN

### Makita OY Lithuanian Branch

#### Lithuanian factory service center

L. Zamenhofo Str. 3, Vilnius, LT-06332, LITHUANIA  
Phone: +370 5 236 0400  
Fax: +370 5 236 0407  
www.makita.lt

## SWEDEN

### Makita Sweden

Bergkällavägen 36A 192 79 SOLLENTUNA SWEDEN  
Phone: +46-8-505-819-00  
Fax: +46-8-505-819-69  
www.makita.se

## NORWAY

### Makita Norway

Løxaveien 15 1351 Rud Norway  
Phone: +47-67 17 69 00  
Fax: +47 67 17 69 01  
www.makita.no

## THE NETHERLANDS

### Makita Nederland B.V.

#### Head office

Park Forum 1101 5657HK Eindhoven  
Phone: +31-(0)40-206-4040  
Fax: +31-(0)40-206-4096  
www.makita.nl

#### Utrecht Service Center

Straat van Gibraltar 6, 3446CM Woerden  
Phone: +31-(0)40-206-4040  
Fax: +31-(0)40-206-4096

## BELGIUM

### S.A. Makita N.V.

Jan-Baptist Vinkstraat 2 3070 Kortenberg  
Phone: +32-(0)2-257-1840  
Fax: +32-(0)2-253-0101  
www.makita.be

#### Antwerp

Makita FSC Boom Industrieweg 1C 2850 Boom  
Phone: +32-(0)2-257-1840

#### Charleroi Service Center

Avenue de Heppignies 6 6220 Fleurus

## GERMANY

### Makita Werkzeug GmbH

#### Head office

Makita Platz 1, 40885 Ratingen  
Phone: +49 (0)2102 1004-0  
Fax: +49 (0) 2102 1004-128  
www.makita.de www.dolmar.de/

#### Makita Service Center Hamburg

Jenfelder Strasse 51, 22045 Hamburg  
Phone: +49 (0) 2102 1004-456  
Fax: +49 (0) 2102 1004-493

#### Makita Service Center Berlin

Gartenfelder Strasse 29 – 37 Gebäude 44, 13599 Berlin  
Phone: +49 (0)30 339 756 50

#### Makita Service Center Lehrte

Everner Strasse 30, 31275 Lehrte  
Phone: +49 (0)5132 5042153  
Fax: +49 (0)2102 1004475  
www.makita.de

#### Makita Logistics Center South Germany

Baumschulenstrasse 1B, 93083 Obertraubling  
Phone: +49 (0)2102 1004-410  
www.makita.de

#### Makita Engineering Germany GmbH

Jenfelder Strasse 38, 22045 Hamburg  
Phone: +49-(0)40-66986-0  
Fax: +49-(0)40-66986-352  
www.makita-engineering.de

## DENMARK

### Makita Elværktøj Danmark

#### Denmark office

Erhvervsbyvej 14, 8700 Horsens  
Phone: +45-76-254400  
Fax: +45-76-254401  
www.makita.dk

## SWITZERLAND

### Makita SA

Chemin du Vuasset 7 CH-1028 Preverenges  
Phone: +41-(0)21-811-5656  
Fax: +41-(0)21-811-5678  
www.makita.ch

#### Espace Mitteland Training Service Center

Lerchenweg 14 CH-4538 Oberbipp  
Phone: +41-(0)32 631 01 76  
Fax: +41-(0)32 631 01 79

## AUSTRIA

### Makita Werkzeug Gesellschaft m.b.H.

Airportstraße 4, A-2401 Fischamend  
Phone: +43-(0)2232-77700-0  
Fax: +43-(0)2232-77700-13  
www.makita.at

## SLOVENIA

### MAKITA.d.o.o.

Brnčičeva 17, SI-1231 Ljubljana-Črnuče, Slovenia  
Phone: +386(0) 590 83 600  
Fax: +386(0) 590 83 601  
www.makita-see.com

## CROATIA

### Croatia factory service center

Kreše Golika 3A, HR- 10000 Zagreb  
Phone: +385 1 2078 252  
www.makita-see.com

## UKRAINE

### Makita Ukraine LLC

61 Oleha Onikiyenko Str., Brovary, Kyiv region 07400, Ukraine  
Phone: +38 (044) 494-23-70  
+38 (044) 494-23-71  
Fax: +38 (044) 494-23-73  
www.makita.ua

#### Dnipro FSC

5 Kursanta Korobogata Str., Dnipro, Dnipropetrovsk region 49124, Ukraine  
Phone: +380 (44) 492-27-73

## POLAND

### Makita Sp. z o.o.

#### Head office

ul. Bestwińska 103 43-346 Bielsko - Biala  
Phone: +48-(0)33-484-0200  
Fax: +48-(0)33-818-4059  
www.makita.pl

#### Warsaw branch

Moszna-Parcela 29 05-840 Brwinów  
Phone: +48-(0)22-177-7300

## CZECH REPUBLIC

### Makita, spol. s r.o.

Kaštanová 555/125d 620 00 Brno  
Phone: +42-(0)5-432-16944  
Fax: +42-(0)5-432-16946  
www.makita.cz

#### Prague Service Center

K Bílému Vrchu 3040/16, 193 00 Prague 9  
Phone: +42-(0)2-991-40585

## SLOVAKIA

### Makita s.r.o.

Priemyselná 26 974 01 Banská Bystrica  
Phone: +421-(0)48-4161-772  
Fax: +421-(0)48-4161-769  
www.makita.sk

## HUNGARY

### Makita Elektromos Kiszélesztés Kft.

8000 Székesfehérvár, Kukorica utca 7.  
Phone: +36-22-507-472  
Fax: +36-22-507-484  
www.makita.hu

## MIDDLE EAST/ AFRICA

### ROMANIA

#### Makita Romania S.R.L.

Str. I.C.Bratianu nr. 164 Depozit Faza 3  
077030 Comuna Branesti jud. Ilfov  
Romania  
Phone: +40 21 569 80 61  
+40 21 569 80 62  
Fax: +40 21 569 80 59  
www.makita.ro

#### Cluj-Napoca Factory Service Center

Str. Bld. Muncii, Nr. 68, 400641  
Cluj, Romania  
Phone: +40 21 569 80 61

#### Iasi Factory Service Center

Boulevard Poitiers No. 2, 700671  
Iasi, Romania  
Phone: +40 21 569 80 61

#### SC Makita EU SRL

Str.I.C. Bratianu, nr.164, Comuna Branesti,  
jud. ILFOV, ROMANIA 077030  
Phone: +40-21-310-7675  
Fax: +40-21- 200-0219

### BULGARIA

#### Makita Bulgaria EOOD

Okolovrasten Pat (circle road), No.373,  
Sofia 1186, Bulgaria  
Phone: +359-2-921-0551  
Fax: +359-2-921-0550  
www.makita.bg

### RUSSIA

#### Makita LLC

Krasno proletarskaya street, 4, 1F  
Entrance3, Moscow 127006  
Phone: +7 (495) 109-88-66

#### MAKITA LLC, Vladivostok branch

83, 1st RABOCHAYA str. ARTEM 692770,  
RUSSIA  
Phone: +7(423)202-65-23

#### MAKITA LLC, Novosibirsk branch

15, Dargomyzhskogo str., Novosibirsk,  
Russia, 630047  
Phone: +7 (383) 209 18 19  
Fax: +7 (383) 209 18 19

#### MAKITA LLC, St.Petersburg branch

Shpalernaya street 54, letter B, premise  
25-H, Saint Petersburg, Russia, 191015  
Phone: +7 (812) 244-47-84

#### MAKITA LLC, Samara Branch

3 Mirnaya str., Samara, Russia, 443035  
Phone: +7 (846) 202 90 50  
+7 (846) 202 42 83

#### MAKITA LLC, Krasnodar branch

32/2, Turgenevskoe, Takhtamukaisky  
district, Adygea Republic, Russia, 385132  
Phone: +7 (861) 238 24 97

#### MAKITA LLC, Yekaterinburg Branch

5, pereulok Avtomatiki, Yekaterinburg,  
Russia, 620049  
Phone: +7 (343) 286 00 09

### BELARUS

#### MAKITA LLC, Belarus Branch

33, Briketa str., Minsk, Republic of  
Belarus, 220063  
Phone: + 375 (17) 516 11 11  
www.makita.by

### GEORGIA

#### LTD «Makita Georgia»

64, D. Guramishvili avenue, 0141, Tbilisi,  
Georgia  
Phone: +995 032 243 06 43

### KAZAKHSTAN

#### Makita Kazakhstan LLP

Kommunalnaya 39, 050016, Almaty,  
Kazakhstan  
Phone: +7 727 233 0827  
Fax: +7 727 382 7921

### UNITED ARAB EMIRATES

#### Makita Gulf FZE

P.O. Box 17133,  
Jebel Ali Free Zone, Dubai, UAE  
Phone: +971-(0)4-8860-804  
Fax: +971-(0)4-8860-805  
www.makita.ae

### TANZANIA

#### MAKITA AFRICA LIMITED

P.O. Box 20998, 2nd Floor, Staywell Office  
Building, Haile Selassie Road, Masaki,  
Msasani Peninsula, Dar es Salaam,  
Tanzania  
Phone: +255 22 2602870

### MOROCCO

#### MAKITA MOROCCO SARLAW

Rte Zenata Lot Marhaba Show Room N5  
Espace Commercial Asteria Amal 5 A S,  
20250 Casablanca, Morocco  
Phone: +212 522 344808  
Fax: + 212 522 355696

## OCEANIA

### AUSTRALIA

#### Makita (Australia) Pty. Ltd.

##### Head office

2 Litton Close Pemulwuy, NSW. 2145  
Phone: +61 1300 361 690  
Fax: +61 1300 361 770  
www.makita.com.au

##### Hobart office

32a Chapel Street Glenorchy, TAS 7010  
Phone: +61 1300 361 690  
Fax: +61 1300 361 770

##### Perth office

374A Kenwick Rd Maddington WA 6109  
Phone: +61 1300 361 690  
Fax: +61 1300 361 770

##### Factory Service Center

Sydney, Melbourne, Brisbane, Perth,  
Hobart, Townsville

### NEW ZEALAND

#### Makita (New Zealand) Ltd.

##### Head office

46 Westpoint Drive, Hobsonville,  
Auckland 0618  
Phone: +64-(0)9-479-8251  
Fax: +64-(0)9-479-8259  
www.makita.co.nz

##### Christchurch Office

Unit10, 11, 8 Islington Ave, Christchurch  
,8042  
Phone: +64-(0)3-930-0500

##### Factory Service Center

Auckland, Christchurch, Wellington

# Accessory Catalogue



**Makita Corporation**

3-11-8 Sumiyoshi-cho, Anjo, Aichi 446-8502 Japan  
[www.makita.com](http://www.makita.com)



**XGT LXT CXT**  
RoHS REACH