

Electric pumps

2013

SEA LAND S.r.l.
Via E. Mattei, 25
I-35038 TORREGLIA (PD) - Italy
Tel. +39 049 5212944-9930154
Fax +39 049 5212772
sealand@sea-land.it
www.sea-land.it

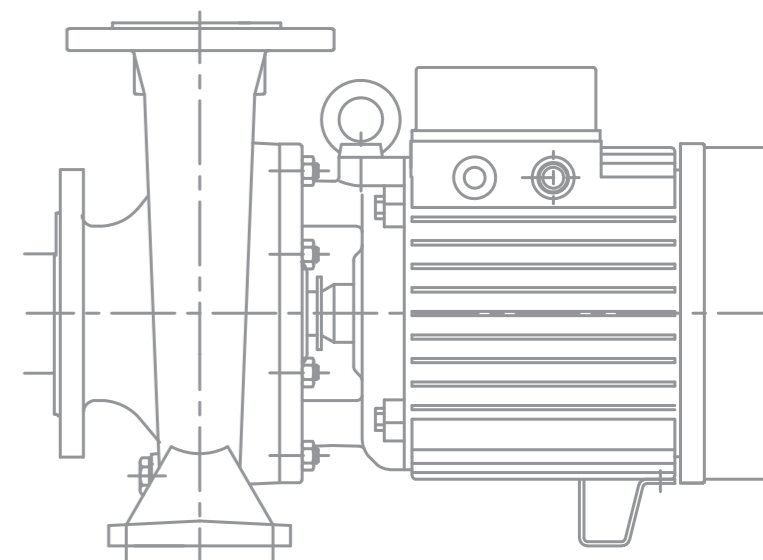
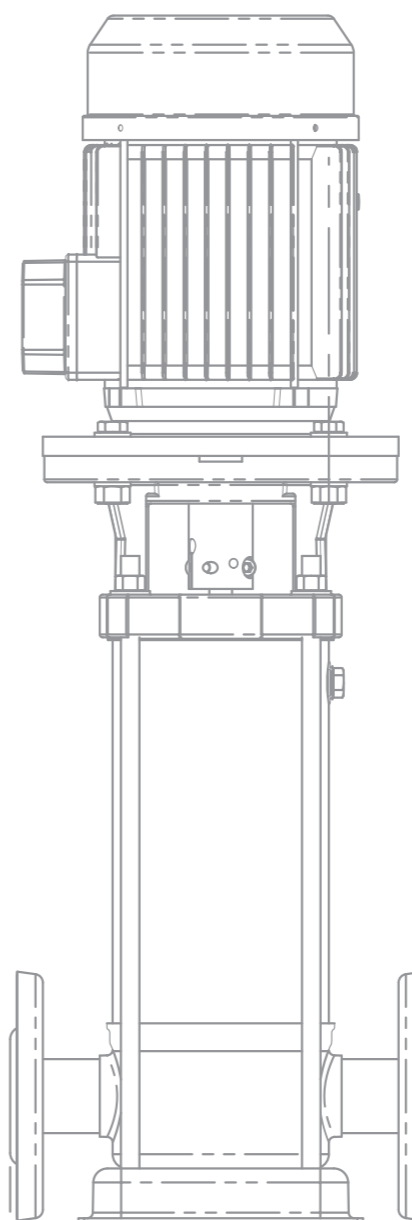

made in italy

Tutti sanno che una cosa è impossibile da realizzare,
finché arriva uno sprovveduto che non lo sa
e la inventa.

A. Einstein

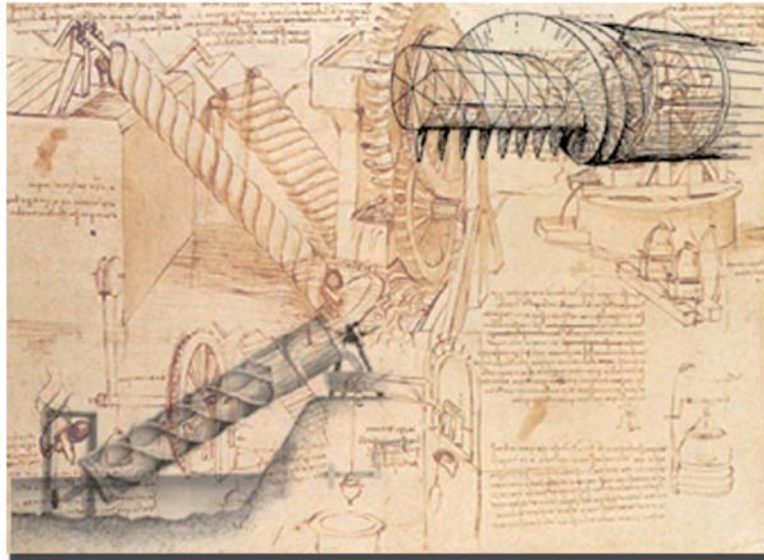

Archimede 300 a.C.

Evoluzione e passione per il nostro lavoro

MADE IN



SINCE 1990

Applicazioni - Application - Applications - Aplicaciones



Riempimento per accumulo
Filling water storage tanks
Chargement des citernes et réservoirs
Carga de los tanques de almacenamiento



Distribuzione e riciclo di impianti domestici
Water distribution or circulation in domestic systems
Distribution et la circulation des systèmes domestique
Distribución y circulación en planta doméstica



Prosciugamento di scavi e terreni acquitrinosi
Drainage of excavations or flooded areas
Drainage des excavations et de terrains marécageux
Drenaje de excavaciones inundadas y zonas pantanosas



Impianti di raffreddamento, condizionamento e circolazione
Cooling plant, air conditioning and circulating plants
Systèmes de refroidissement, de climatisation et de la circulation
Plantas de refrigeración, aire acondicionado y circulación



Riciclo d'acqua in impianti industriali
Water circulation into industrial plants
Recirculation de l'eau dans les installations industrielles
Recirculación de agua en las plantas industriales



Irrigazione agricola
Agricultural irrigation
Irrigation agricole
Riego Agrícolas



Svuotamento di sentine delle barche
Draining bilges of boats
Drainage les fonds de cale des bateaux
Drenaje del achique



Fontane e giochi d'acqua
Fountains and water plays
Fontaines et jeux d'eau
Fuentes y juegos de agua



Montaggio in macchine industriali
Installation into industrial machines
Installation dans les machines industrielles
Instalación en maquinaria industrial



Piccola irrigazione
Small irrigation plants
Petite irrigation
Pequeños riegos



Impieghi in pozzi
Deep wells
Pompaggio in forages
Empleo en pozos profundos



Gruppi di pressurizzazione
Booster set
Groupes de surpression
Equipos de presión



Prosciugamento di ambienti allagati e pozzetti di raccolta
For dewatering flooded areas & pits
Dainage des zones inondé et puits
Drenaje de zonas inundadas y cuencas de captura



Impianti di sollevamento acque nere e fosse biologiche
Wastewater plants and septic tank
Relevage des eaux usées et des fosses septiques
Equipos de elevación las aguas residuales y fosas sépticas



Svuotamento di vasche e piscine
Swimming pools and collecting tank dewatering
Vidange des réservoirs et des piscines
Vaciado de tanques y piscinas



Travasare gasolio da fusti, cisterne o altri contenitori
For diesel oil decanting from drums or tanks
Transfert de gasoil de barils ou citernes
Trasiego de gas-oil desde los tambores o tanques









Lavaggi con getto d'acqua
Water jet washing systems
Lavage au jet d'eau
Limpiar con jet de agua



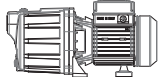
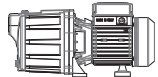
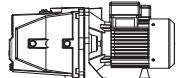



AUTODESCANTI
SELF PRIMING
AUTOCEBANTES
AUTOAMORÇANTES



MONOGIRANTE
SINGLE IMPELLER
À UNE ROUE
MONOIMPULSOR



	"MJ"	pag. 10
	"MJX"	pag. 14
	"JET"	pag. 18
	"JEXI"	pag. 22
	"JB"	pag. 26
	"JAP"	pag. 30
	"PA"	pag. 34
	"PLA"	pag. 38



	"K"	pag. 50
	"KA"	pag. 56
	"KC"	pag. 60
	"KP"	pag. 64
	"KL"	pag. 68
	"KXL"	pag. 72





PERIFERICHE
PERIPHERAL
PÉRIPHÉRIQUES
PERIFÉRICAS



CENTRIFUGHE MULTISTADIO
MULTISTAGE CENTRIFUGAL
CENTRIFUGES MULTISTADIO
CENTRÍFUGAS MULTIETAPA

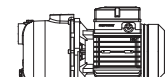

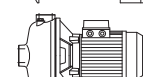
	"BASIC-ONDINA"	pag. 42
	"PL"	pag. 46

	"MC"	pag. 76
	"MK"	pag. 80
	"KD"	pag. 84
	"BK"	pag. 88

NORMALIZZATE
NORMALIZED
NORMALISÉES
NORMALIZADAS

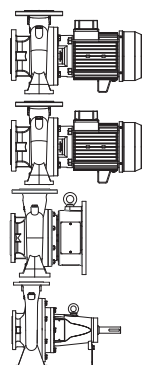

"CN" pag. 94

"CNG" pag. 96

"ING" pag. 98

"BSN" pag. 116

MULTISTADIO IN LINEA
IN LINE MULTISTAGE
ULTISTADIO EN LIGNE
MULTIETAPA EN LINEA

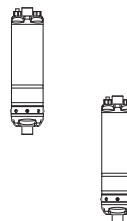

"VERTÌ J Line" pag. 150

"VERTÌ Line" pag. 154

GRUPPI DI PRESSURIZZAZIONE
AUTOMATICI
AUTOMATIC PRESSURE SYSTEMS
GROUPES DE PRESSURISATION
AUTOMATIQUES
GRUPOS DE PRESURIZACIÓN
AUTOMÁTICO



MULTISTADIO AD ASSE VERTICALE
VERTICAL MULTISTAGE
MULTISTADIO À AXE VERTICAL
MULTIETAPA DE EJE VERTICAL

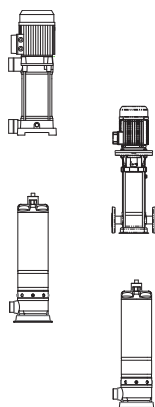

"MKV" pag. 126

"MVX" pag. 132

"VERTÌ J" pag. 140

"VERTÌ" pag. 144

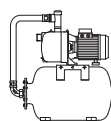

"TEAM" pag. 160

"TEAM EXPORT" pag. 164

"CONTROL TEAM" pag. 164

"INVENTApress" pag. 166

"TEAM PRESS 2" pag. 168

"KUBO V-L" pag. 170

"KUBO INVENTApress" pag. 172

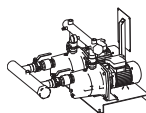
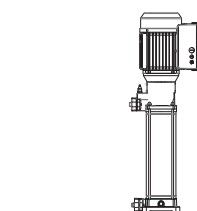

CIRCOLATORI A ROTORE BAGNATO
WET ROTOR CIRCULATORS
CIRCULATEURS À ROTOR NOYÉ
CIRCULADORA CON ROTOR HÚMEDO

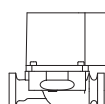

"CKR" pag. 174

PER TRAVASO GASOLIO
FOR DIESEL OIL
POUR TRANSVASEMENT GASOIL
DE TRASIEGO POR GAS-OIL



SOMMERSIBILI PER ACQUE REFLUE
SUBMERSIBLE FOR WASTEWATER PUMPS
SUBMERSIBLES POUR EAUX USÉES
SUMERGIBLES PARA AGUAS RESIDUALES



"QUICK" pag. 178



"DVJ" pag. 208

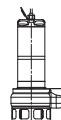

"DVX" pag. 212

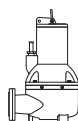

"DV 25" pag. 216

"DV30" pag. 218

SOMMERSIBILI PER DRENAGGIO
SUBMERSIBLE DRAINING
SUBMERSIBLES POUR DRAINAGE
SUMERGIBLES PARA DRENAJE

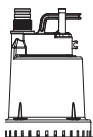

"SKUBA" pag. 180



"VENEZIA" pag. 184



"VENEZIA Vortex" pag. 188

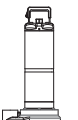

"SA" pag. 192

"DA" pag. 196

"DAX" pag. 200

STAZIONI DI SOLLEVAMENTO AUTOMATICO
PER ACQUE DI SCARICO
AUTOMATIC WASTEWATER LIFTING STATION
STATIONS DE RELÈVEMENT
AUTOMATIQUES D'EAUX USÉES
ESTACIONES DE ELEVACIÓN AUTOMÁTICA
PARA AGUAS RESIDUALES

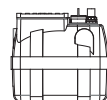

"GREEN BOX" pag. 224

SOMMERSIBILI PER ACQUE SPORCHE
CON SISTEMA TRITURATORE
WASTEWATER PUMPS WITH CRUSHING SYSTEM
SUBMERSIBLES POUR LES EAUX USÉES
AVEC SYSTÈME BROYEUR
SUMERGIBLES PARA AGUAS SUCIAS
CON SISTEMA TRITURADOR



DA SENTINA
FOR BILGE
DE CALE
DE SENTINA

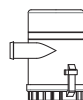

"YACHT" pag. 228



"STR" pag. 204

MONOBLOCCO SOMMERSIBILI MULTISTADIO
SUBMERSIBLE MONOBLOC MULTISTAGE
MONOBLOC SUBMERSIBLES MULTISTADIO
MONOBLOQUE SUMERGIBLES MULTITETAPA

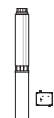

"VERTI J SUB"	pag. 230
"VERTI SUB"	pag. 234
"LESTA"	pag. 240

SISTEMA ELETTRONICO A VELOCITA' VARIABILE
VARIABLE SPEED ELECTRONIC SYSTEM
SYSTÈME ÉLECTRONIQUE À VITESSE VARIABLE
SISTEMA ELECTRÓNICO A VELOCIDAD VARIABLE



"INVENTA"	pag. 264
-----------	----------

SOMMERSE PER POZZI PROFONDI
SUBMERSIBLE FOR DEEP WELL
IMMÉRÉES POUR FORAGES
SUMERGIBLES PARA POZOS PROFUNDOS



"SL"	pag. 244
"SL6"	pag. 252

QUADRI ELETTRICI DI CONTROLLO E COMANDO
ELECTRIC CONTROL PANEL
PANNEAU DE CONTRÔLE ÉLECTRIQUE
CUADRO ELÉCTRICO DE CONTROL



"CDA M"	pag. 265
"CDA T"	pag. 265
"CBX"	pag. 266
"CBX 05/300"	pag. 267
"CBT"	pag. 267
"CB2X"	pag. 268
"CB2T"	pag. 268
"CBS"	pag. 269
"CB2S"	pag. 270
"CBR"	pag. 271
"CBRT"	pag. 271
"CB2R"	pag. 272
"CB2RT"	pag. 272

MOTORI SOMMERSI
SUBMERSIBLE MOTORS
MOTEURS IMMÉRÉS
MOTORES SUMERGIDOS

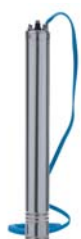

"SUBMOTO 4"	pag. 260
"SUBMOTO 6"	pag. 262

KIT DI PRESSURIZZAZIONE
PRESSURE SYSTEM KIT
KIT DE PRESSION
KIT DE PRESIÓN

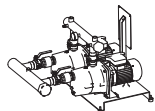

" KIT PRESS "

pag. 273

ACCESSORI PER ELETTROPOMPE
PUMPS ACCESSORIES
ACCESSOIRES POUR ÉLECTROPOMPES
ACCESORIOS PARA ELECTROBOMBAS



pag. 274

APPENDICE TECNICA
TECHNICAL APPENDIX
ANNEXE TECHNIQUE
APÉNDICE TÉCNICO

pag. 276

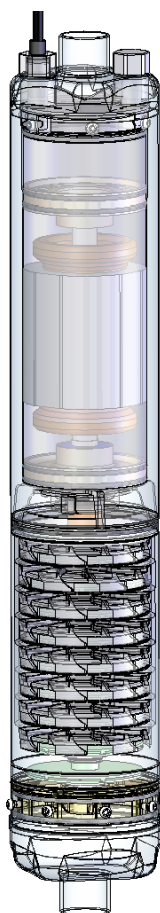

Alta tecnologia e investimenti sulla qualità per la soddisfazione del cliente

La Sea-Land S.r.l. sin dal 1990, è specializzata nello studio, realizzazione, industrializzazione e produzione di elettropompe centrifughe, autoadescanti, sommergibili e sommerse, per applicazioni domestiche, civili ed industriali, con prestazioni fino a 250 m³/h.

Tutti i nostri prodotti vengono realizzati interamente in Italia negli stabilimenti di Torreglia in provincia di Padova e Ponteviso in provincia di Brescia.

Tecnici altamente qualificati, costantemente aggiornati, e con l'ausilio di moderni sistemi di progettazione e collaudo, sono in grado di sviluppare prodotti estremamente innovativi, performanti, e soprattutto affidabili nel tempo.

In Sea-Land tutto ruota attorno all'obiettivo di creare tecnologie in grado di dare valore per se e per chi la sceglie, ma soprattutto, fornendo al cliente l'elevato standard di relazione sia tecnica che umana che hanno permesso alla Sea-Land di essere presente con proprie organizzazioni o distributori fidelizzati in più di 60 paesi nel mondo essendo ovunque riconosciuta come un'azienda italiana su cui fare sicuro affidamento.

Il ns. sistema di qualità, prevede come riferimento principale la soddisfazione del cliente con il quale l'azienda condivide l'obiettivo di migliorare la gamma di servizi e prodotti oltre naturalmente alla forte volontà di continuare nell'opera di inventare soluzioni sempre più originali e rispettosi dell'ambiente che ci circonda.

High technology and quality investment for "customer satisfaction"

Sea-Land S.r.l. since 1990, is committed to study, realization, industrialization and production of centrifugal, self-priming and submersible electric pumps for domestic and civil use, for irrigation and industrial plants, having a range up to 250 m³/h.

All our products are entirely produced in Italy in the factories of Torreglia in the province of Padua and Ponteviso in the province of Brescia.

Highly qualified technicians, constantly updated and using the latest projecting and testing software are able to develop very innovative products of high performance and especially of long term reliability.

In Sea-Land everything it's revolving around the target to develop technologies which create value to its products and to who chooses them, but above all, to provide an high technical and human standard relation. Such vision granted to Sea-Land to be recognized, in more than 60 countries all over the world trough branches or qualified distributors, as an Italian company to rely on.

Our QUALITY SYSTEM, as main object have the customer satisfaction with which one the company share the target of improving the range of service and products, as well with a deep intention to continue his opera to invent solutions more and more original and respectful of the environment around of us.





Haute technologie et investissements su la qualité pour la satisfaction des clients

Dès 1990 SEA LAND est spécialisé dans l'étude, la réalisation, l'industrialisation et la production de électropompes centrifuges, auto-amorçantes, sous-marines et submergées pour application domestique, civile et industrielle, avec des performances jusqu'à 250 m³/h.

Tous nos produits sont réalisés entièrement en Italie dans les établissements de Torreglia dans la province de Padoue et de Ponteviso dans la province de Brescia. Techniciens hautement qualifiés et mises à jour constamment, avec systèmes modernes de conception et essais, sont en mesure de développer des produits extrêmement innovants, hautement efficaces et particulièrement fiables dans le temps.

Le but de SEA LAND est la création de technologies qui donnent de la valeur pour soi-même et pou ceux qui les choisissent, mais en particulier de fournir au client un haut standard de rapport technique et humain qu'a permis à SEA LAND d'être présent - avec des propres organisations ou loyaux distributeurs - en plus de 60 pays dans le monde, en étayant reconnue partout comme une société italienne dont on peut se fier.

Notre système de qualité a comme principal point de référence la satisfaction du client avec lequel on veut améliorer la gamme de services et produits, et bien sûr le fort désir de continuer dans l'oeuvre d'inventer des solutions plus et plus originales, en ayant un respect total de l'environnement qui nous entoure.

Alta tecnología y inversiones en calidad para la satisfacción del cliente

La Sea-Land Srl desde 1990, y se especializa en el diseño, desarrollo, industrialización y producción de bombas centrífugas, autocebantes, sumergibles y bombas sumergibles para uso doméstico, municipal e industrial, con un máximo de 250 m³/h.

Todos nuestros productos son totalmente fabricados en Italia en los establecimientos de Torreglia en la provincia de Padua y Ponteviso en la provincia de Brescia.

Altamente calificados técnicos se actualizan constantemente, y con la ayuda de un diseño moderno y pruebas, son capaces de desarrollar productos altamente innovadores, el rendimiento, y sobre todo de larga duración.

En Sea-Land, todo gira en torno al objetivo de crear tecnologías que dan valor para él y para los que opten por ella, pero sobre todo, ofrecer a sus clientes el alto nivel de relación, tanto técnicos y humanos que ha permitido a la Sea-Land estar presente con sus organizaciones o distribuidores leales en más de 60 países de todo el mundo donde quiera que se reconoce como una empresa italiana muy confiable.

El ns. sistema de calidad como la principal referencia proporciona la satisfacción del cliente con el que la compañía comparte el objetivo de mejorar la gama de servicios y productos, además de la firme voluntad, por supuesto, seguir trabajando para inventar soluciones que son originales y respetuosos para el "nuestro medio ambiente".



"MJ"

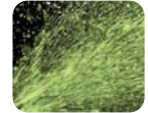

Nuova generazione di pompe autoadescanti
New generation self priming electric pumps
Nouvelle génération de pompes autoamorçantes
Nueva generación de bombas autocebantes

NOMENCLATURA PARTI DI RICAMBIO
SPARE PARTS LIST
NOMENCLATURE PIECES DE RECHANGE
NOMENCLATURA REPUESTOS

Estremamente silenziose
Risparmio energetico
Alte prestazioni

Extremely noiseless
Energy saving
High performance

Extrêmement silencieuses
Économie d'énergie
Performances élevées

Extremadamente silenciosas
Ahorro energético
Altas prestaciones

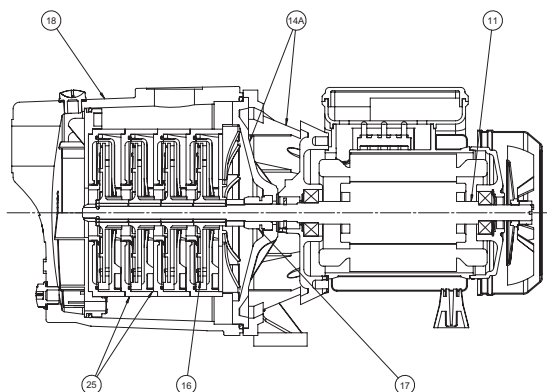

- 11** Albero con rotore – Pump shaft + rotor
Arbre + rotor – Eje rotor
- 14A** Kit supporto – Motor bracket kit
Kit support – Kit soporte
- 16** Girante – Impeller
Turbine – Impulsor
- 17** Tenuta meccanica – Mechanical seal
Garniture mécanique – Cierre mecánico
- 18** Corpo pompa – Pump body
Corp de pompe – Cuerpo bomba
- 25** Diffusore – Diffuser
Diffuseur – Difusor

ELETTROPOMPE CENTRIFUGHE AUTOADESCANTI MULTISTADIO

Estremamente silenziose ed affidabili le elettropompe centrifughe multistadio della serie MJ sono state progettate per pompare da pozzi, serbatoi o vasche di raccolta, liquidi puliti, senza parti abrasive, senza corpi solidi in sospensione, non esplosivi o aggressivi per i materiali della pompa.

- Aspirazione fino a 8-9 m di profondità
- Temperatura max. del liquido fino a 35 °C per uso domestico (CEI EN 60335-2-41) o 90 °C per altri usi e temperatura ambiente fino a 40 °C.
- Portate fino a ~ 8 m³/h.
- Prevalenze fino a ~ 44 m.

CARATTERISTICHE COSTRUTTIVE

- Corpo pompa: ghisa G20 con trattamento anticorrosione
- Supporto motore: alluminio pressofuso UNI 5076
- Diffusori: Tecnopolimero
- Giranti: Tecnopolimero con anello in acciaio inox Aisi 304
- Albero pompa: acciaio inox Aisi 420F
- Tenuta meccanica: carbone-ceramica.

MOTORE

I motori di comando sono del tipo asincrono a gabbia di scoiattolo chiusi, a ventilazione esterna.

- Motoprotettore incorporato e condensatore permanentemente inserito per i tipi monofasi.
- La protezione del motore nella versione trifase è a cura del cliente e si raccomandano apparecchiature in accordo con le norme vigenti.
- Isolamento classe F – servizio S1- grado di protezione IP 44
- Protezione morsettiera IP 54.

ÉLECTROPOMPES CENTRIFUGES AUTOAMORÇANTES MULTISTADIO

Extrêmement silencieuses et fiables les électropompes centrifuges multistadio de la série MJ ont été conçues pour pomper de puits, de réservoirs ou de cuves, des liquides propres, sans parties abrasives, sans corps liquides en suspension, non explosifs ou agressifs pour les matériaux de la pompe.

- Aspiration jusqu'à 8-9 m de profondeur
- Température max. du liquide jusqu'à 35 °C pour utilisation domestique (CEI EN 60335-2-41) ou 90 °C pour d'autres utilisations et température ambiante jusqu'à 40 °C.
- Plage d'utilisation jusqu'à ~ 8 m³/h.
- Hauteur manométrique jusqu'à ~ 44 m.

CARACTERISTIQUES DE CONSTRUCTION

- Corps de pompe : En fonte G20 avec traitement anti-corrosion
- Lanterne: aluminium moulé sur pression UNI 5076
- Diffuseurs: Technopolymère
- Turbine: Technopolymère
- Abris de pompe: acier inox Aisi 420F
- Garniture mécanique: Carbone dur - Céramique

MOTOR

Le moteurs sont asynchrones à cage d'écureuil fermés à ventilation extérieure monofasiques,

- Pour les modèles monophasés son avec protection thermique et condensateur connecté en permanence
- Pour les modèles triphasés, la protection est à la charge de l'utilisateur. A recommandé l'équipement conformément à la réglementation
- A Classe d'isolation F - service S 1 – protection IP44
- Protection IP54 dans le terminal

SELF-PRIMING CENTRIFUGAL MULTISTAGE ELECTRIC PUMPS

Extremely noiseless and reliable the centrifugal multistage self priming electric pumps series MJ have been designed to pump from wells, basins or storage tanks, clean liquids, non-explosive or aggressive for the pump's materials, without abrasives and suspended solids.

- Maximum suction up to 8-9 m.
- Liquid temperature not higher than 35 °C for domestic use (CEI EN 60335-2-41) or 90 °C for other use, while the ambient temperature must not be higher than 40 °C.
- Flow rate up to ~ 8 m³/h.
- Heads up to ~ 44 m.

TECHNICAL FEATURES

- Pump body: cast iron G20 with anti-corrosive coating.
- Motor bracket: in die casting aluminium UNI 5076.
- Diffusers: Techno-polymer
- Impellers: Techno-polymer with stainless steel Aisi 304 ring
- Pump shaft: stainless steel Aisi 420F
- Mechanical seal: carbon-ceramics.

MOTOR

The control motors are asynchronous, squirrel cage-type, closed, with external ventilation.

- Incorporated motor protection and capacitor always on, for single-phase models.
- The motor protection for three-phase models must be installed by the customer. Equipment compliant with current standards should be used.
- Class of insulation: F-service: S1-Degree of protection: IP 44.
- Terminal board protection: IP 54.

ELECTROBOMBAS CENTRÍFUGAS AUTOCEBADAS MULTIETAPA

Extremadamente silenciosas y fiables las electrobombas centrífugas multi-etapa de la serie MJ han sido proyectadas para bombear desde pozos, depósitos o tanques de recogida, líquidos limpios sin partes abrasivas, sin cuerpos sólidos en suspensión, que no sean explosivos ni agresivos para los materiales de la bomba.

- Aspiración hasta 8-9 m de profundidad
- Temperatura max. del líquido hasta 35 °C para uso doméstico (CEI EN 60335-2-41) o 90 °C para otros usos y temperatura ambiente hasta 40 °C.
- Caudal hasta ~ 8 m³/h.
- Alturas hasta ~ 44 m.

CARACTERÍSTICAS DE CONSTRUCCIÓN

- Corps de pompe: Fundición gris G20 con tratamiento contra-corrosión
- Difusores: De tecnopolímero
- Rodetes: De tecnopolímero
- Eje de la bomba: de acero Inox Aisi 420F
- Cierre mecánico: De cerámica y grafito

MOTOR

Los motores de accionamiento son asíncrono de jaula de ardilla cerrados, ventilados externamente

- Para los modelos monofásicos, protección térmica y condensador incorporado
- Para los modelos trifásicos de la protección se encarga el usuario y el equipo recomendado de acuerdo con las normas
- Aislamiento de Clase F – funcionamiento S1- protección IP44
- Protección IP54 para el terminal

min⁻¹ ~ 2900

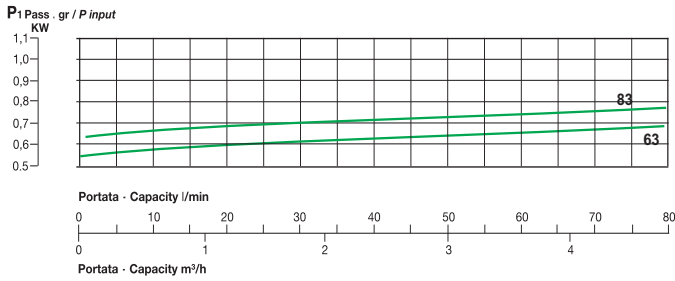
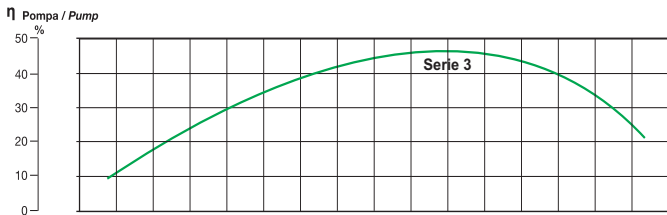
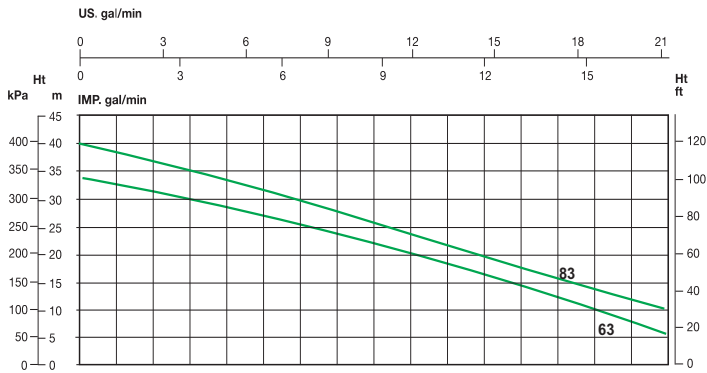

min⁻¹ ~ 3400

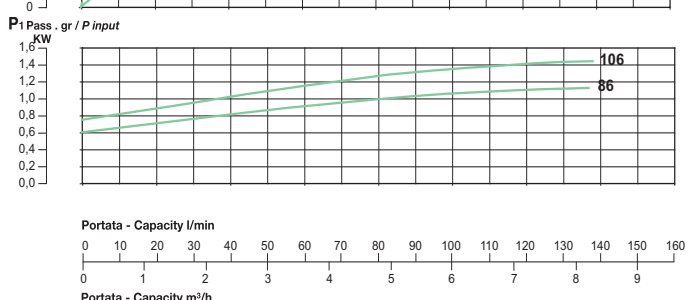
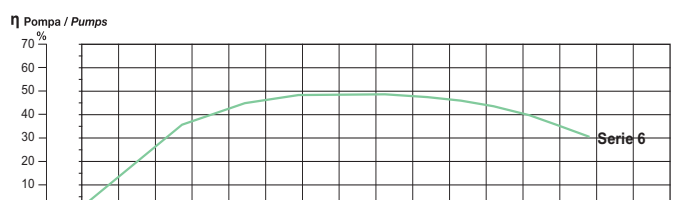
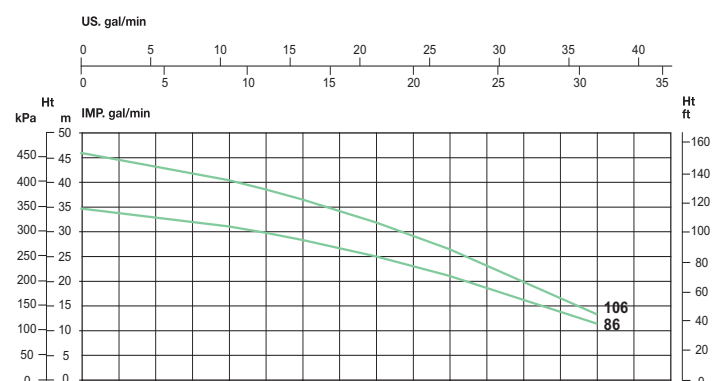
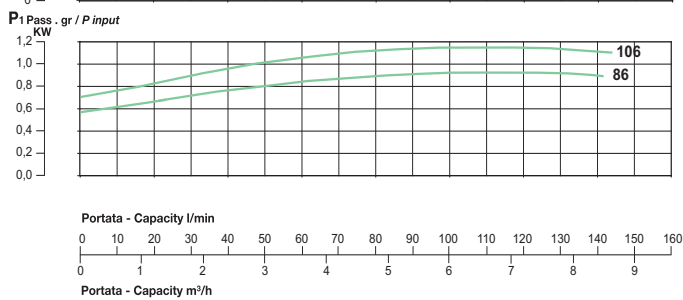
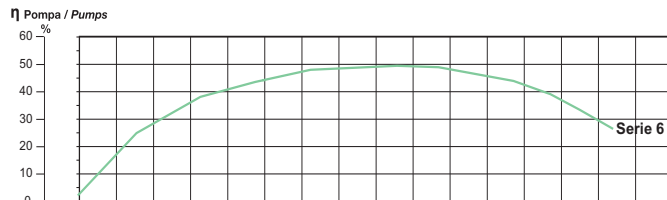
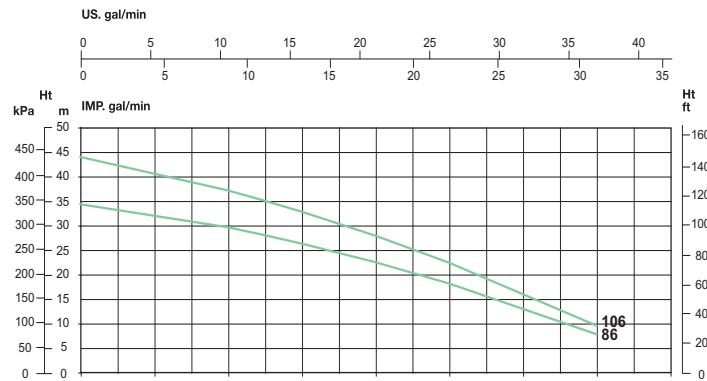
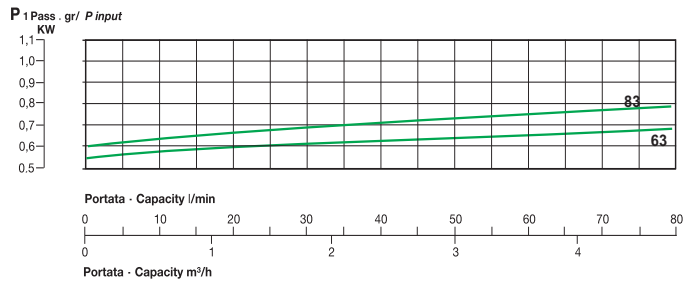
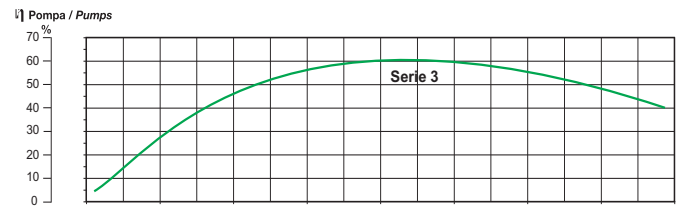
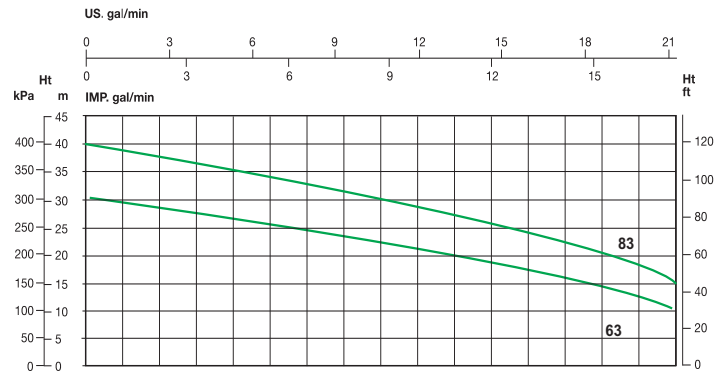

"MJX"



Nuova generazione di pompe autoadescanti
New generation self priming electric pumps
Nouvelle génération de pompes autoamorçantes
Nueva generación de bombas autocebantes

NOMENCLATURA PARTI DI RICAMBIO
SPARE PARTS LIST
NOMENCLATURE PIECES DE RECHANGE
NOMENCLATURA REPUESTOS

Estremamente silenziose
Risparmio energetico
Alte prestazioni

Extremely noiseless
Energy saving
High performance

Extrêmement silencieuses
Économie d'énergie
Performances élevées

Extremadamente silenciosas
Ahorro energético
Altas prestaciones

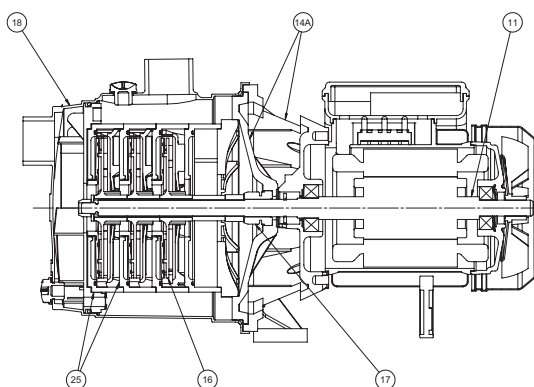

- 11 Albero con rotore – Pump shaft + rotor
Arbre + rotor – Eje rotor
- 14A Kit supporto – Motor bracket kit
Kit support – Kit soporte
- 16 Girante – Impeller
Turbine – Impulsor
- 17 Tenuta meccanica – Mechanical seal
Garniture mécanique – Cierre mecánico
- 18 Corpo pompa – Pump body
Corp de pompe – Cuerpo bomba
- 25 Diffusore – Diffuser
Diffuseur – Difusor

TOP RANGE

ELETTROPOMPE CENTRIFUGHE AUTOADESCANTI MULTISTADIO INOX

Estremamente silenziose ed affidabili le elettropompe centrifughe multistadio della serie MJX sono state progettate per pompare da pozzi, serbatoi o vasche di raccolta, liquidi puliti, senza parti abrasive, senza corpi solidi in sospensione, non esplosivi o aggressivi per i materiali della pompa

- Aspirazione fino a 8-9 m di profondità
- Temperatura max. del liquido fino a 35 °C per uso domestico (CEI EN 60335-2-41) o 90 °C per altri usi e temperatura ambiente fino a 40 °C.
- Portate fino a ~ 9 m³/h.
- Prevalenze fino a ~ 50 m.

CARATTERISTICHE COSTRUTTIVE

- Corpo pompa: Acciaio inox Aisi 304
- Supporto motore: alluminio pressofuso UNI 5076
- Diffusori: Tecnopolimero
- Giranti: Tecnopolimero con anello in acciaio inox Aisi 304
- Albero pompa: acciaio inox Aisi 420F
- Tenuta meccanica: carbone-ceramica

MOTORE

I motori di comando sono del tipo asincrono a gabbia di scoiattolo chiusi, a ventilazione esterna

- Motoprotettore incorporato e condensatore permanentemente inserito per i tipi monofasi
- La protezione del motore nella versione trifase è a cura del cliente e si raccomandano apparecchiature in accordo con le norme vigenti
- Isolamento classe F – servizio S1- grado di protezione IP 44
- Protezione morsettiera IP 54

ÉLECTROPOMPES CENTRIFUGES AUTOAMORÇANTES MULTISTADIO INOX

Extrêmement silencieuses et fiables les électropompes centrifuges multistadio de la série MJX ont été conçues pour pomper de puits, de réservoirs ou de cuves, des liquides propres, sans parties abrasives, sans corps liquides en suspension, non explosifs ou agressifs pour les matériaux de la pompe

- Aspiration jusqu'à 8-9 m de profondeur
- Température max. du liquide jusqu'à 35 °C pour utilisation domestique (CEI EN 60335-2-41) ou 90 °C pour d'autres utilisations et température ambiante jusqu'à 40 °C.
- Plage d'utilisation jusqu'à ~ 9 m³/h.
- Hauteur manométrique jusqu'à ~ 50 m.

CARACTERISTIQUES DE CONSTRUCTION

- Corps de pompe : Acier inox Aisi 304
- Lanterne: aluminium moulé sur pression UNI 5076
- Diffuseurs: Technopolymère
- Turbine: Technopolymère anneau en acier inox Aisi 304
- Abre de pompe: acier inox Aisi 420F
- Garniture mécanique: Carbone dur – Céramique

MOTOR

Le moteurs sont asynchrones à cage d'écurieil fermés à ventilation extérieure monofásicos,

- Pour le modèles monophasé son avec protection thermique et condensateur connecté en permanence
- Pour les modèles triphasés, la protection est à la charge de l'utilisateur. A recommandé l'équipement conformément à la réglementation
- A Classe d'isolation F - service S 1 – protection IP44
- Protection IP54 dans le terminal

SELF-PRIMING CENTRIFUGAL STAINLESS STEEL MULTISTAGE ELECTRIC PUMPS

Extremely noiseless and reliable the centrifugal multistage self priming electric pumps series MJX have been designed to pump from wells, basins or storage tanks, clean liquids, non-explosive or aggressive for the pump's materials, without abrasives and suspended solids

- Maximum suction up to 8-9 m
- Liquid temperature not higher than 35 °C for domestic use (CEI EN 60335-2-41) or 90 °C for other use, while the ambient temperature must not be higher than 40 °C
- Flow rate up to ~ 9 m³/h
- Heads up to ~ 50 m

TECHNICAL FEATURES

- Pump body: stainless steel Aisi 304
- Motor bracket: in die casting aluminium UNI 5076
- Diffusers: Techno-polymer
- Impellers: Techno-polymer with stainless steel Aisi 304 ring
- Pump shaft: stainless steel Aisi 420F
- Mechanical seal: carbon-ceramics

MOTOR

The control motors are asynchronous, squirrel cage-type, closed, with external ventilation

- Incorporated motor protection and capacitor always on, for single-phase models
- The motor protection for three-phase models must be installed by the customer. Equipment compliant with current standards should be used
- Class of insulation:F-service:S1-Degree of protection: IP 44
- Terminal board protection: IP 54

ELECTROBOMBAS CENTRÍFUGAS AUTOCEBANTES MULTIETAPA INOX

Extremadamente silenciosas y fiables las electrobombas centrífugas multi-etapa de la serie MJX han sido proyectadas para bombear desde pozos, depósitos o tanques de recogida, líquidos limpios sin partes abrasivas, sin cuerpos sólidos en suspensión, que no sean explosivos ni agresivos para los materiales de la bomba.

- Aspiración hasta 8-9 m de profundidad
- Temperatura max. del líquido hasta 35 °C para uso doméstico (CEI EN 60335-2-41) o 90 °C para otros usos y temperatura ambiente hasta 40 °C.
- Caudal hasta ~ 9 m³/h.
- Alturas hasta ~ 50 m.

CARACTERÍSTICAS DE CONSTRUCCIÓN

- Cuerpo de bomba: De acero Inox AISI304
- Soporte: fundición de aluminio UNI 5076
- Difusores: De tecnopolímero
- Rodetes: De tecnopolímero
- Eje de la bomba: de acero Inox AISI420F
- Cierre mecánico: De cerámica y grafito

MOTOR

Los motores de accionamiento son asíncrono de jaula de ardilla cerrados, ventilados externamente

- Para los modelos monofásicos, protección térmica y condensador incorporado
- Para los modelos trifásicos de la protección se encarga el usuario y el equipo recomendado de acuerdo con las normas
- Aislamiento de Clase F – funcionamiento S1- protección IP44
- Protección IP54 para el terminal

50 Hz - min⁻¹ ~ 2900

TIPO TYPE		Potenza nominale Nominal power		Potenza assorbita Input power [W]		Condensatore Capacitor 450 V max	Corrente assorbita Input current [A]			Portata - Capacity									
Monofase Single-phase	Trifase Three-phase			a	b	[μF]	1~230V	3~230V	3~400V	Q [m ³ /h]	0	2,4	3	3,6	4,8	6	8,4	9	
a	b	kW	HP	a	b					Q [l/1']	0	40	50	60	80	100	140	150	
MJX 63 M	-	0,37	0,5	700	-	14	3,3	-	-	Prevalenza (m C.A.) Total head (m W.C.)									
MJX 83 M	MJX 83 T	0,59	0,8	740	700	14	3,3	2,8	1,5	H [m]	31,8	22,9	19,9	16,7	9,1				
MJX 103 M	MJX 103 T	0,74	1	1050	1100	20	4,7	4,7	2,5		37,5	25,8	22,4	18,9	10,8				
MJX 123 M	MJX 123 T	0,88	1,2	1325	1260	25	5,9	4,2	2,4		52,6	37,9	33,5	28,7	18,4				
MJX 86 M	-	0,59	0,8	980	-	16	4	-	-		70,6	51,1	44,1	36,4	20,2				
MJX 106 M	MJX 106 T	0,74	1,0	1160	1160	20	5,1	3,8	2,1		34,1	29,3	27,7	26,0	22,0	17,3	5,9	2,6	
MJX 126 M	MJX 126 T	0,88	1,2	1440	1470	25	6,2	5,1	2,5		43,0	36,2	34,1	31,9	27,0	21,5	8,7	5,1	
										52,1	43,7	41,2	38,4	32,2	25,2	8,9	4,3		

a) ~ Monofase 230 V

b) ~ Trifase 230/400 V

60 Hz - min⁻¹ ~ 3400

TIPO TYPE		Potenza nominale Nominal power		Potenza assorbita Input power [W]		Condensatore Capacitor 450 V max	Corrente assorbita Input current [A]				Portata - Capacity									
Monofase Single-phase	Trifase Three-phase			a	b	[μF]	1-115 V	1-220 V	3-220 V	3-380 V	Q [m ³ /h]	0	2,4	3	3,6	4,8	6	8,4	9	
a	b	kW	HP	a	b						Q [l/1']	0	40	50	60	80	100	140	150	
MJX 63 M	-	0,37	0,5	660	-	14	6,3	2,9	-	-	Prevalenza (m C.A.) Total head (m W.C.)									
MJX 83 M	MJX 83 T	0,59	0,8	850	550	14	8	3,7	2,2	1,3	H [m]	29,4	22,3	20,0	17,4	11,7				
MJX 103 M	MJX 103 T	0,74	1	1250	840	25	11,3	5,7	3,8	2		39,4	29,8	26,8	23,5	16,1				
MJX 123 M	MJX 123 T	0,88	1,2	1500	990	25	-	7,3	4,1	2,3		51,5	41,3	37,8	34,0	25,2				
MJX 86 M	-	0,59	0,8	1200	1500	16	11,2	5,4	-	-		70,2	57,0	52,2	46,9	34,6				
MJX 106 M	MJX 106 T	0,74	1	1500	900	20	-	6,8	3,8	2,1		34,5	30,9	29,6	28,2	24,9	20,9	11,3	8,5	
MJX 126 M	MJX 126 T	0,88	1,2	1820	1260	25	-	8,3	5,1	2,8		45,8	40,3	38,4	36,4	31,7	26,3	13,2	9,4	
											57,2	50,6	48,5	46,2	40,9	34,8	20,3	16,2		

a) ~ Monofase 115/220 V

b) ~ Trifase 220/380 V

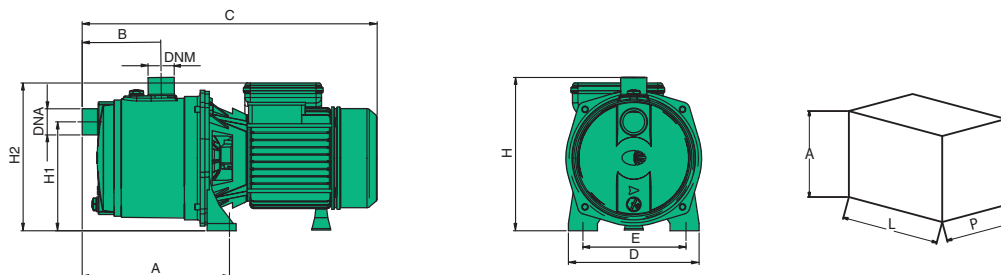

TIPO TYPE	DIMENSIONI [mm] DIMENSIONS [mm]										IMBALLO [mm] PACKING [mm]			PESO WEIGHT [kg]	
	A	B	C	D	E	F	H	H1	H2	DNA	DNM	A	L		P
MJX 63	210	118	400	180	140	187	204	155	200	1"	1"	250	450	190	8,4
MJX 83	210	118	400	180	140	187	204	155	200	1"	1"	250	450	190	9
MJX 103	225	135	435	180	140	187	204	155	200	"	1"	250	450	190	11,8
MJX 123	295	182	485	180	140	187	204	155	230	1"	1"	280	500	220	13,4
MJX 86	210	118	428	180	140	187	204	155	200	1"	1"	250	450	190	10
MJX 106	210	118	428	180	140	187	204	155	200	1"	1"	250	450	190	10,4
MJX 126	225	135	435	180	140	187	204	155	230	1"	1"	280	500	220	12,2

min⁻¹ ~ 2900

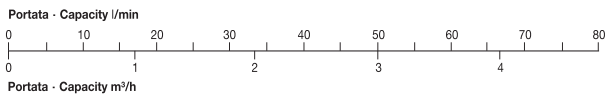
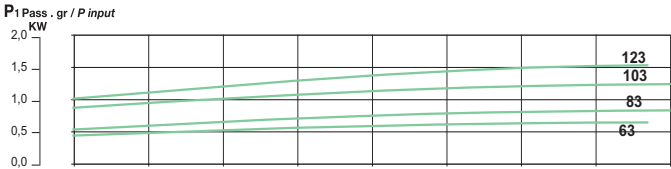
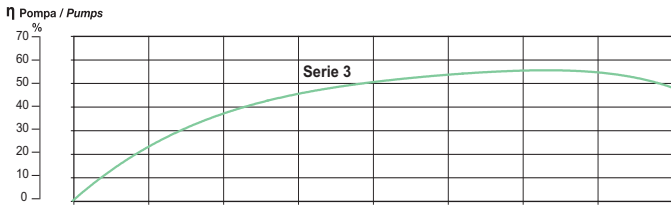
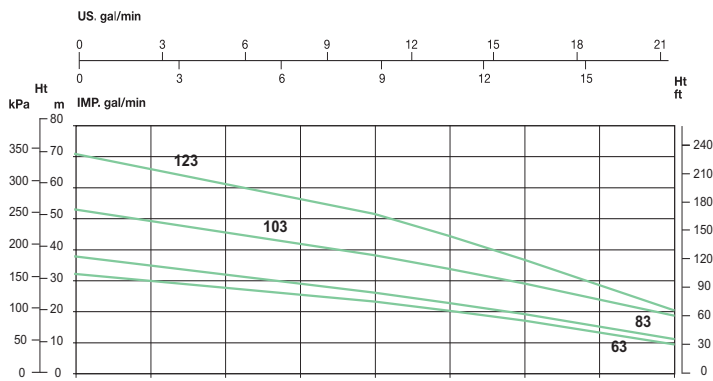

min⁻¹ ~ 3400

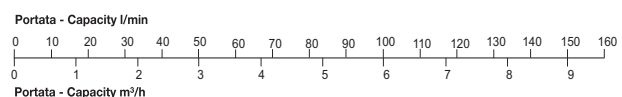
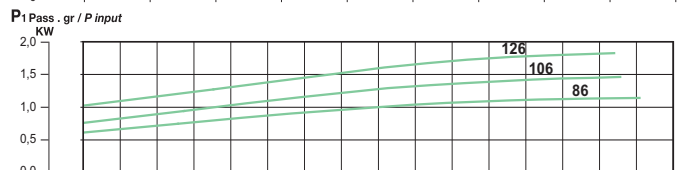
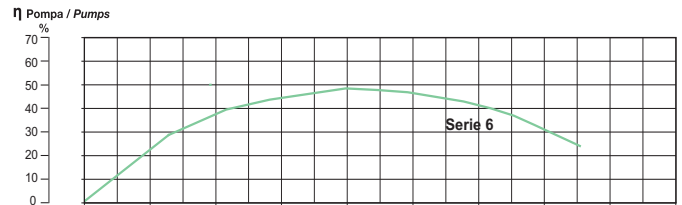
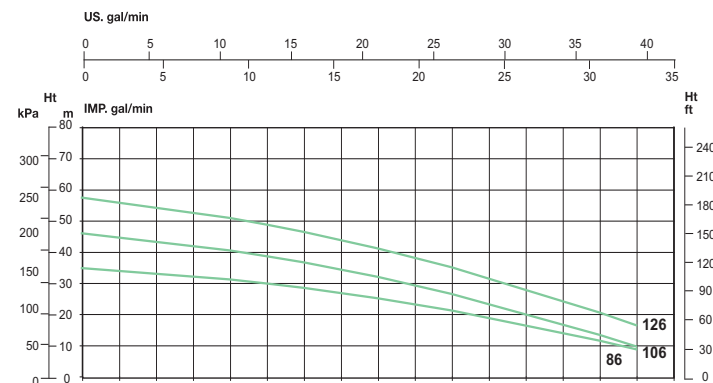
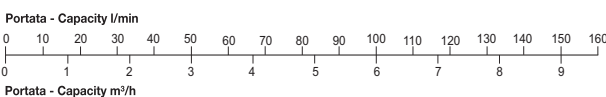
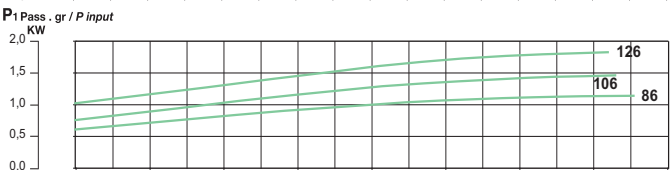
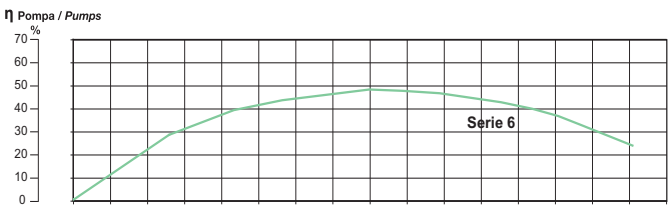
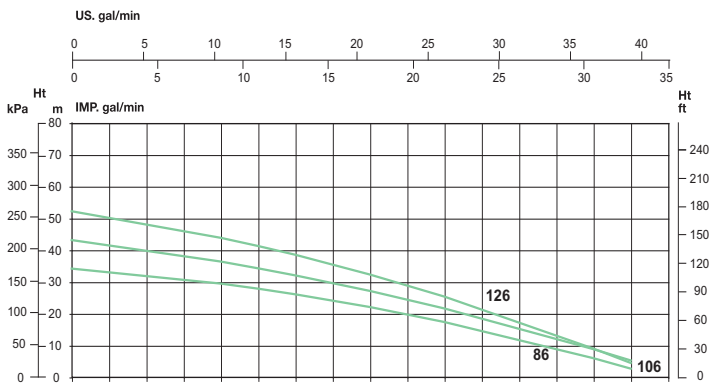
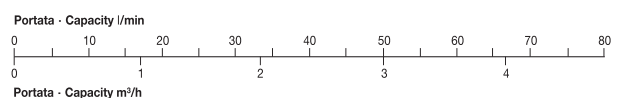
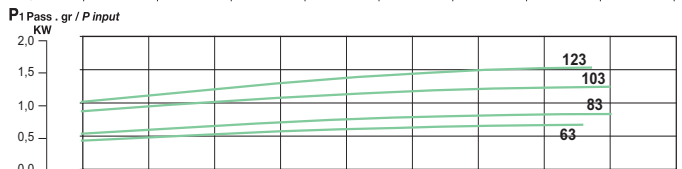
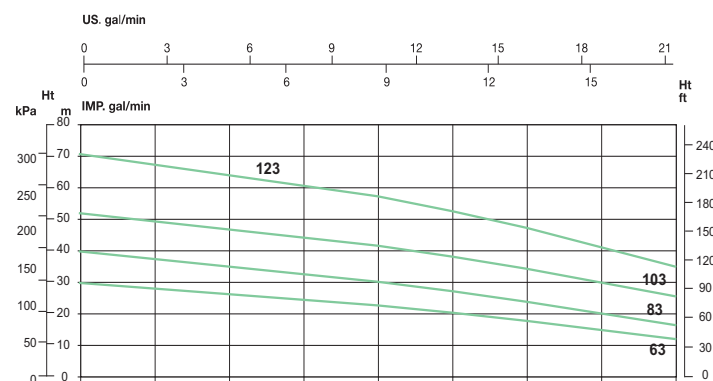

"JET"



NOMENCLATURA PARTI DI RICAMBIO
SPARE PARTS LIST
NOMENCLATURE PIECES DE RECHANGE
NOMENCLATURA REPUESTOS

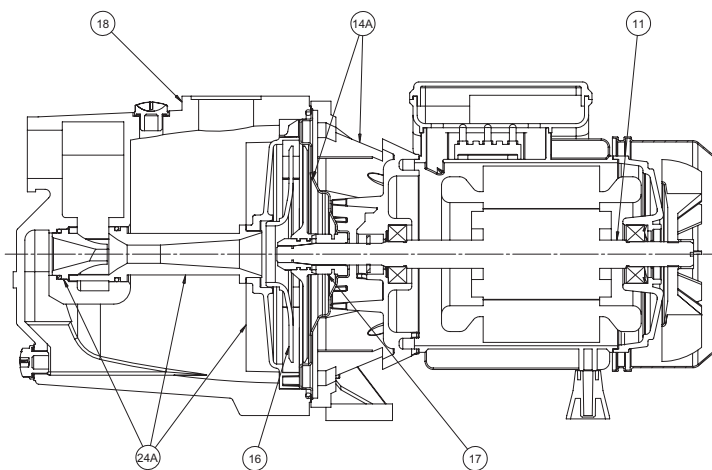

- 11** Albero con rotore – Pump shaft + rotor
Arbre + rotor – Eje rotor
- 14A** Kit supporto – Motor bracket kit
Kit support – Kit soporte
- 16** Girante – Impeller
Turbine – Impulsor
- 17** Tenuta meccanica – Mechanical seal
Garniture mécanique – Cierre mecánico
- 18** Corpo pompa – Pump body
Corp de pompe – Cuerpo bomba
- 24A** Ugello, venturi e diffusore – Diffuser, Nozze & Venturi
Gicleur, venturi et diffuseur – Tobera, venturi y difusor

ELETTROPOMPE CENTRIFUGHE AUTOADESCANTI

Le elettropompe centrifughe autoadescenti serie JET sono state progettate per aspirare acque pulite da pozzi anche se miscelate a gas

- Aspirazione fino a 8-9 m di profondità
- Temperatura max. del liquido fino a 35 °C per uso domestico (CEI EN 60335-2-41) o 60 °C per altri usi e temperatura ambiente fino a 40 °C
- Portate fino a ~ 9.5 m³/h.
- Prevalenze fino a ~ 60 m.

CARATTERISTICHE COSTRUTTIVE

- Corpo pompa: ghisa G20 con trattamento anticorrosione
- Supporto motore: alluminio pressofuso UNI 5076 (ghisa per JET 152-302)
- Diffusore, Ugello e Venturi: Tecnopolimero
- Giranti: Tecnopolimero (ottone stampato UNI-EN 12165 per JET 152-302)
- Albero pompa: acciaio inox Aisi 420F (Aisi 304 per JET 152-302)
- Tenuta meccanica: carbone-ceramica

MOTORE

I motori di comando sono del tipo asincrono a gabbia di scoiattolo chiusi, a ventilazione esterna

- Motoprotettore incorporato e condensatore permanentemente inserito per i tipi monofasi
- La protezione del motore nella versione trifase è a cura del cliente e si raccomandano apparecchiature in accordo con le norme vigenti
- Isolamento classe F – servizio S1- grado di protezione IP 44
- Protezione morsettiera IP 54

ÉLECTROPOMPES CENTRIFUGES AUTOAMORÇANTES

Les électropompes centrifuges autoamorçantes série JET ont été conçues pour aspirer des eaux propres de puits même mélangées à du gaz

- Aspiration jusqu'à 8-9 m de profondeur
- Température max. du liquide jusqu'à 35 °C pour utilisation domestique (CEI EN 60335-2-41) ou 60 °C pour d'autres utilisations et température ambiante jusqu'à 40 °C
- Plage d'utilisation jusqu'à ~ 9.5 m³/h.
- Hauteur manométrique jusqu'à ~ 60 m.

CARACTERISTIQUES DE CONSTRUCTION

- Corps de pompe : En fonte G20 avec traitement anti-corrosion
- Lanterne: aluminium moulé sur pression UNI 5076 (en fonte pour JET 152-302)
- Diffuseur, et groupe venturi:: Technopolymère
- Turbine: Technopolymère (laiton étampé UNI-EN 12165 pour JET 152-302)
- Abre de pompe: acier inox Aisi 420F (Aisi 304 pour JET 152-302)
- Garniture mécanique: Carbone dur - Céramique

MOTOR

Le moteurs sont asynchrones à cage d'écuriel fermés à ventilation extérieure monofasiques,

- Pour les modèles monophasés son avec protection thermique et condensateur connecté en permanence
- Pour les modèles triphasés, la protection est à la charge de l'utilisateur. A recommander l'équipement conformément à la réglementation
- A Classe d'isolation F - service S 1 – protection IP44
- Protection IP54 dans le terminal

SELF-PRIMING CENTRIFUGAL ELECTRIC PUMPS

The self-priming centrifugal electric pumps series JET have been designed to pump clean water from wells, even if mixed with gas

- Maximum suction up to 8-9 m
- Liquid temperature not higher than 35 °C for domestic use (CEI EN 60335-2-41) or 60 °C for other use, while the ambient temperature must not be higher than 40 °C
- Flow rate up to ~ 9.5 m³/h
- Heads up to ~ 60 m

TECHNICAL FEATURES

- Pump body: cast iron G20 with anti-corrosive coating
- Motor bracket: in die casting aluminium UNI 5076 (cast iron for JET 152-302)
- Diffuser, Nozzle & Venturi tube: Techno-polymer
- Impeller: Techno-polymer (stamped brass UNI-EN 12165 JET 152-302)
- Pump shaft: stainless steel Aisi 420F (Aisi 304 for JET 152-302)
- Mechanical seal: carbon-ceramics

MOTOR

The control motors are asynchronous, squirrel cage-type, closed, with external ventilation

- Incorporated motor protection and capacitor always on, for single-phase models
- The motor protection for three-phase models must be installed by the customer. Equipment compliant with current standards should be used
- Class of insulation:F-service:S1-Degree of protection: IP 44
- Terminal board protection: IP 54

ELECTROBOMBAS CENTRÍFUGAS AUTOCEBANTES

Las electrobombas centrifugas autocebantes serie JET han sido proyectadas para aspirar aguas limpias desde pozos aun en el caso de que éstas estén mezcladas con gas.

- Aspiración hasta 8-9 m de profundidad
- Temperatura max. del líquido hasta 35 °C para uso doméstico (CEI EN 60335-2-41) o 60 °C per para otros usos y temperatura ambiente hasta 40 °C
- Caudal hasta ~ 9.5 m³/h.
- Alturas hasta ~ 60 m.

CARACTERÍSTICAS DE CONSTRUCCIÓN

- Cuerpo de bomba: Fundición gris G20 con tratamiento contra-corrosión
- Soporte: fundición de aluminio UNI 5076 (para las JET 152-302)
- Difusores y el grupo venturi: De tecnopolímero
- Rodete: De tecnopolímero (De latón UNI-EN 12165 para las JET 152-302)
- Eje de la bomba: de acero Inox AISI420F (Aisi 304 para las JET 152-302)
- Cierre mecánico: De cerámica y grafito

MOTOR

Los motores de accionamiento son asíncrono de jaula de ardilla cerrados, ventilados externamente

- Para los modelos monofásicos, protección térmica y condensador incorporado
- Para los modelos trifásicos de la protección se encarga el usuario y el equipo recomendado de acuerdo con las normas
- Aislamiento de Clase F – funcionamiento S1- protección IP44
- Protección IP54 para el terminal

50 Hz - min⁻¹ ~ 2900

TIPO TYPE		Potenza nominale Nominal power		Potenza assorbita Input power [W]		Condensatore Capacitor 450 V max	Corrente assorbita Input current [A]			Portata - Capacity																
Monofase Single-phase	Trifase Three-phase	kW	HP	a	b	[μF]	1~230V	3~230V	3~400V	Q [m ³ /h]	0	0,6	1,2	1,8	2,4	3	3,6	Q [l/s]	0	10	20	30	40	50	60	
a	b									Prevalenza (m C.A.) Total head (m W.C.)																
JET 61 M	-	0,44	0,6	600	-	12,5	2,6	-	-	H [m]	35,0	28,6	22,3	18,9	13,8	4,7										
JET 81 M	JET 81 T	0,59	0,8	660	610	14	3	2,2	1,4		37,2	30,6	24,6	20,6	16,0	6,6										
JET 82 M	-	0,59	0,8	820	-	14	3,7	-	-		45,0	38,0	31,0	26,0	20,0	10										
JET 101 M	JET 101 T	0,74	1	980	940	16	4,55	4,1	2,4		46,9	40,3	34,6	29,6	25,6	22,3	19,9									
JET 102 M	JET 102 T	0,74	1	1040	1050	20	4,8	4	2,3		49,5	43,4	37,9	33,0	28,9	25,4	22,6									
JET 122 M	JET 122 T	0,88	1,2	1130	1180	25	5,1	7,6	4,8		54,0	48,3	43,6	38,3	33,5	28,7	24,2									
JET 124 M	JET 124 T	0,88	1,2	1260	1280	25	5,7	5,5	3,2		49,7	46,0	42,4	39,0	35,7	32,5	29,4									

TIPO TYPE		Potenza nominale Nominal power		Potenza assorbita Input power [W]		Condensatore Capacitor 450 V max	Corrente assorbita Input current [A]			Portata - Capacity															
Monofase Single-phase	Trifase Three-phase	kW	HP	a	b	[μF]	1~230V	3~230V	3~400V	Q [m ³ /h]	0	1,2	3	6	7,2	8,4	9,6	Q [l/s]	0	20	50	100	120	140	160
a	b									Prevalenza (m C.A.) Total head (m W.C.)															
JET 152 M	JET 152 T	1,1	1,5	1890	1820	31,5	9	6	3,5	H [m]	45,0	42,0	36,0	27,0	21,0	18									
JET 202 M	JET 202 T	1,5	2	2380	2190	40	11	7,3	4,2		54,0	49,5	43,0	33,0	29,5	27	23								
JET 302 M	JET 302 T	2,2	3,0	2670	2660	50	12,0	8,7	5		60,0	55,0	48,0	38,0	34,0	29,5	27,0								

a) ~ Monofase 230 V

b) ~ Trifase 230/400 V

60 Hz - min⁻¹ ~ 3400

TIPO TYPE		Potenza nominale Nominal power		Potenza assorbita Input power [W]		Condensatore Capacitor 450 V max	Corrente assorbita Input current [A]				Portata - Capacity															
Monofase Single-phase	Trifase Three-phase	kW	HP	a	b	[μF]	1~115 V	1~220 V	3~220 V	3~380 V	Q [m ³ /h]	0	0,6	1,2	1,8	2,4	3	3,6	Q [l/s]	0	10	20	30	40	50	60
a	b										Prevalenza (m C.A.) Total head (m W.C.)															
JET 61 M	-	0,44	0,6	620	-	14	6,4	3	-	-	H [m]	33,3	27,2	21,2	18,0	13,1	4,4									
JET 81 M	-	0,59	0,8	670	-	16	7	3,3	-	-		35,3	29,1	23,4	19,6	15,2	6,6									
JET 82 M	-	0,59	0,8	835	-	16	8	4	-	-		42,8	36,1	29,5	24,7	19,0	9,5									
JET 101 M	JET 101 T	0,74	1	1000	960	20	10,3	4,6	3	1,6		44,6	38,3	32,9	28,1	24,3	21,2	18,9								
JET 102 M	JET 102 T	0,74	1	1035	1060	20	11,0	5,5	3,9	2,2		47,0	41,2	36,0	31,4	27,5	24,1	21,5								
JET 122 M	JET 122 T	0,88	1,2	1150	1200	25	12,0	6,0	4,9	2,6		51,3	45,9	41,4	36,4	31,8	27,3	23,0								
JET 124 M	JET 124 T	0,88	1,2	1260	1380	25	-	7,0	3,6	2,1		50,4	47,2	43,5	40,4	35,1	30,4	29,2								

a) ~ Monofase 115/220 V

b) ~ Trifase 220/380 V

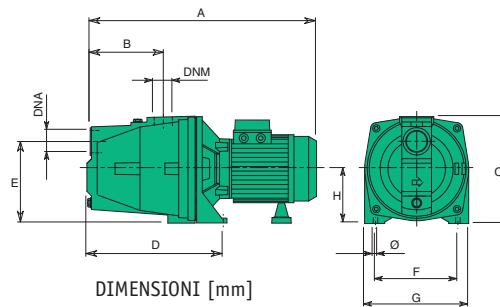

TIPO TYPE	DIMENSIONI [mm] DIMENSIONS [mm]								IMBALLO [mm] PACKING [mm]			PESO WEIGHT [kg]			
	A	B	C	D	E	F	G	Ø	H	DNA	DNM		A	L	P
JET 61	380	110	195	195	155	140	180	9	95	1"	1"	250	190	440	11
JET 81	380	110	195	195	155	140	180	9	95	1"	1"	250	190	440	11,2
JET 82	420	122	210	225	160	140	180	9	95	1"	1"	250	190	440	13,4
JET 101	410	110	210	195	155	140	180	9	95	1"	1"	250	190	440	13,2
JET 102	420	122	210	225	160	140	180	9	95	1"	1"	250	190	440	14,4
JET 122	420	122	210	225	160	140	180	9	95	1"	1"	250	190	440	15,4
JET 124	420	122	210	225	160	140	180	9	95	1"	1"	250	190	440	15,4
JET 152	520	160	235	285	180	180	230	11	120	1" 1/2 G	1" 1/4 G	280	250	600	30,4
JET 202	520	160	235	285	180	180	230	11	120	1" 1/2 G	1" 1/4 G	280	250	600	32,4
JET 302 M	567	160	235	285	180	180	230	11	120	1" 1/2 G	1" 1/4 G	280	250	600	37
JET 302	567	160	235	285	180	180	230	11	120	1" 1/2 G	1" 1/4 G	280	250	600	32,4

min⁻¹ ~ 2900

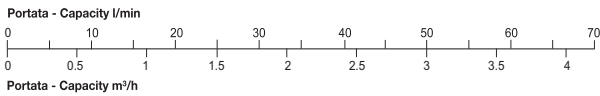
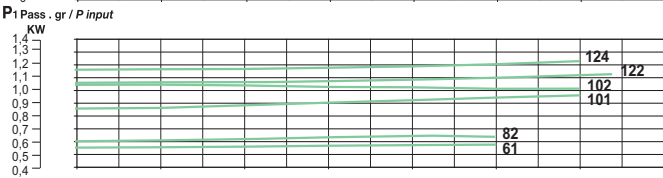
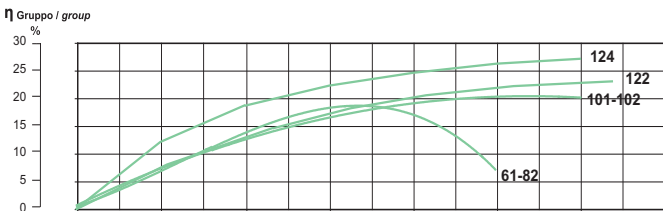
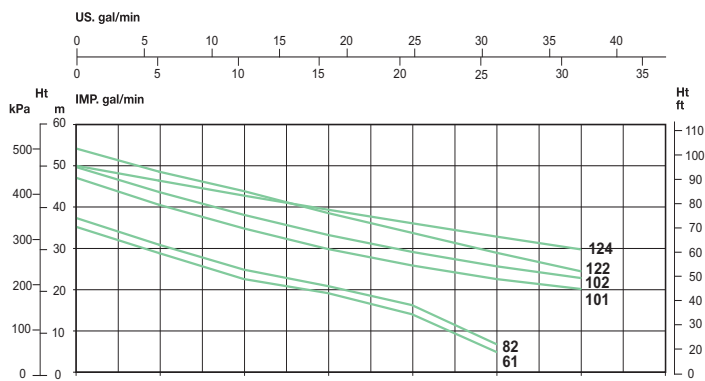

min⁻¹ ~ 3400

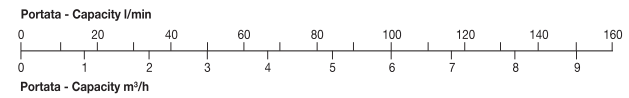
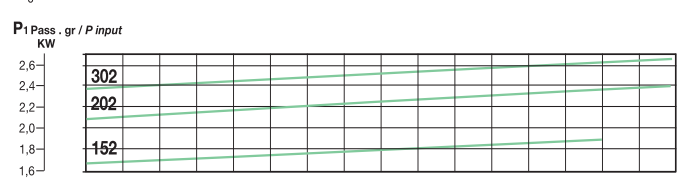
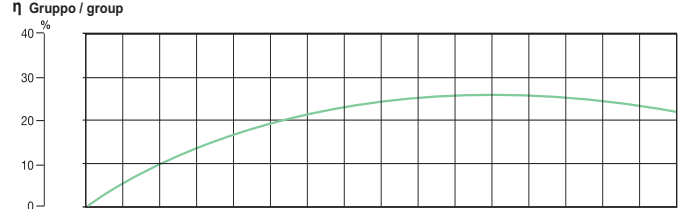
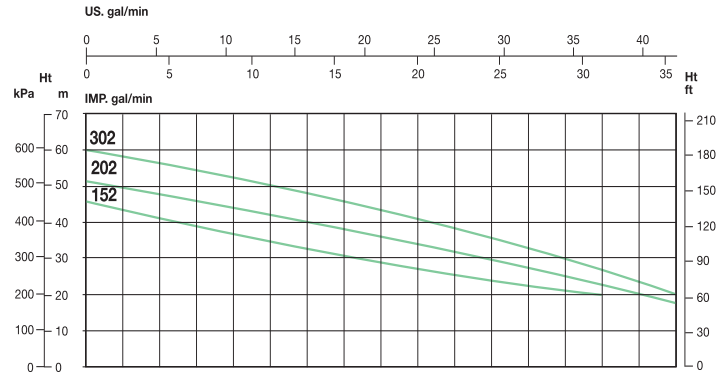
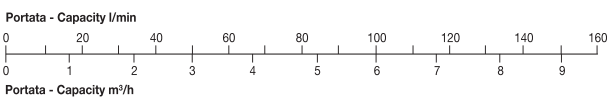
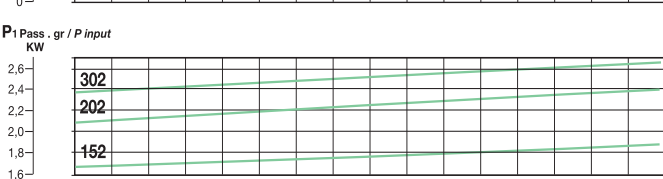
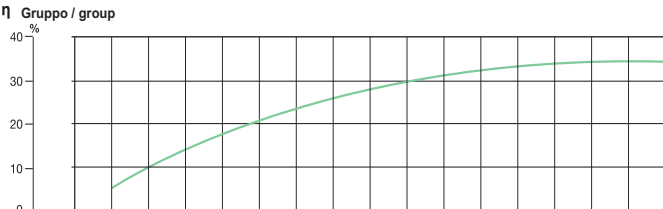
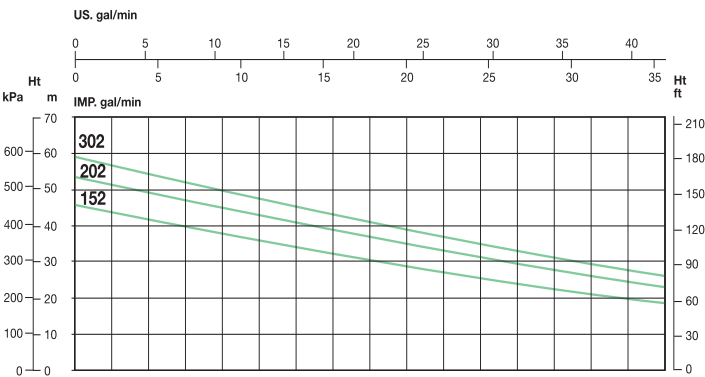
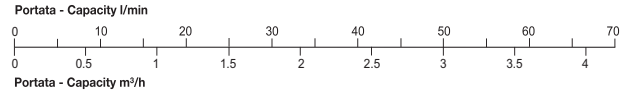
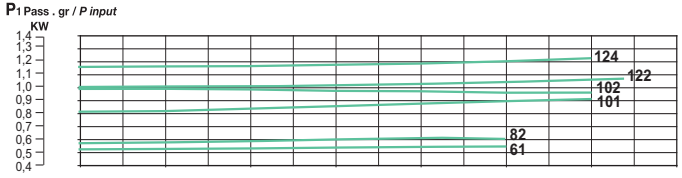
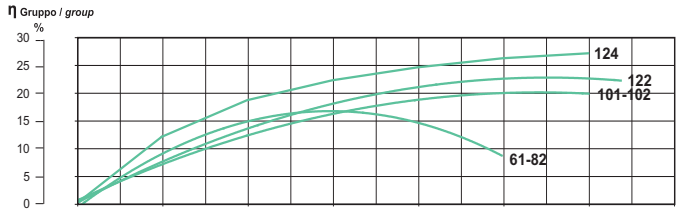
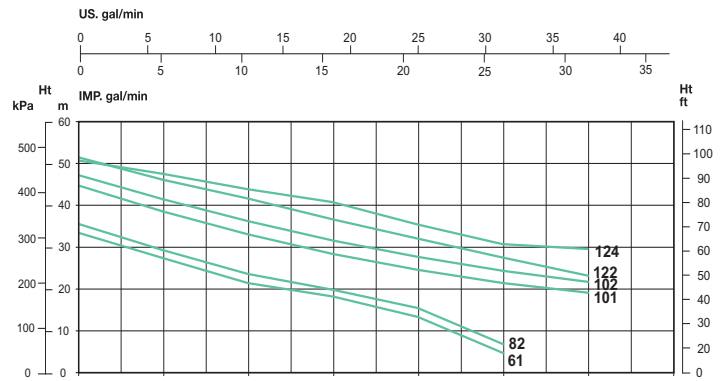

"JEXI"

Electric pumps



NOMENCLATURA PARTI DI RICAMBIO
SPARE PARTS LIST
NOMENCLATURE PIECES DE RECHANGE
NOMENCLATURA REPUESTOS

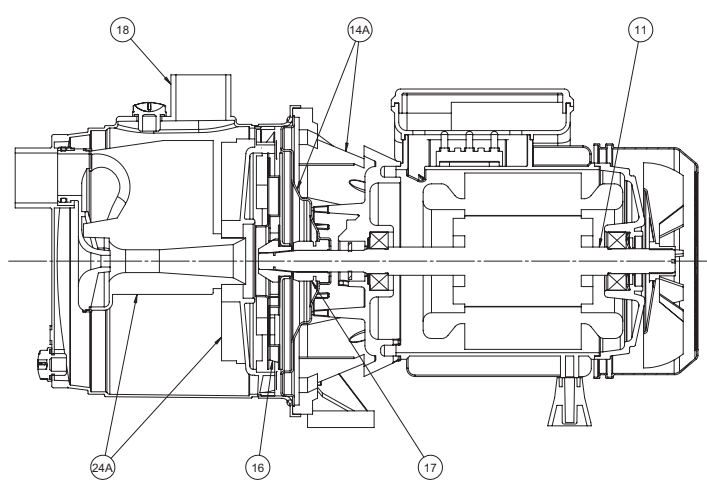

- 11** Albero con rotore – Pump shaft + rotor
Arbre + rotor – Eje rotor
- 14A** Kit supporto – Motor bracket kit
Kit support – Kit soporte
- 16** Girante – Impeller
Turbine – Impulsor
- 17** Tenuta meccanica – Mechanical seal
Garniture mécanique – Cierre mecánico
- 18** Corpo pompa – Pump body
Corp de pompe – Cuerpo bomba
- 24A** Ugello, venturi e diffusore – Diffuser, Nozze & Venturi
Gicleur, venturi et diffuseur – Tobera, venturi y difusor

ELETTROPOMPE CENTRIFUGHE AUTODESCANTI INOX

Le elettropompe centrifughe autoadescenti serie JEXI sono state progettate per aspirare acque pulite da pozzi anche se miscelate a gas

- Aspirazione fino a 8-9 m di profondità
- Temperatura max. del liquido fino a 35 °C per uso domestico (CEI EN 60335-2-41) o 60 °C per altri usi e temperatura ambiente fino a 40 °C
- Portate fino a ~ 4 m³/h.
- Prevalenze fino a ~ 50 m.

CARATTERISTICHE COSTRUTTIVE

- Corpo pompa: acciaio inox Aisi 304
- Supporto motore: alluminio pressofuso UNI 5076
- Diffusore, Ugello e Venturi: Tecnopolimero
- Giranti: acciaio inox Aisi 304 (Tecnopolimero JEXI 65-85-105)
- Albero pompa: acciaio inox Aisi 304 (Aisi 420F JEXI 65-85-105)
- Tenuta meccanica: carbone-ceramica

MOTORE

I motori di comando sono del tipo asincrono a gabbia di scoiattolo chiusi, a ventilazione esterna

- Motoprotettore incorporato e condensatore permanentemente inserito per i tipi monofasi
- La protezione del motore nella versione trifase è a cura del cliente e si raccomandano apparecchiature in accordo con le norme vigenti
- Isolamento classe F –servizio S1- grado di protezione IP 44
- Protezione morsettiera IP 54

ÉLETTROPOMPES CENTRIFUGES AUTOAMORÇANTES INOX

Les électropompes centrifuges autoamorçantes série JEXI ont été conçues pour aspirer des eaux propres de puits même mélangées à du gaz

- Aspiration jusqu'à 8-9 m de profondeur
- Température max. du liquide jusqu'à 35 °C pour utilisation domestique (CEI EN 60335-2-41) ou 60 °C pour d'autres utilisations et température ambiante jusqu'à 40 °C
- Plage d'utilisation jusqu'à ~ 4 m³/h.
- Hauteur manométrique jusqu'à ~ 50 m.

CARACTERISTIQUES DE CONSTRUCTION

- Corps de pompe : acier inox Aisi 304
- Lanterne: aluminium moulé sur pression UNI 5076
- Diffuseur, et groupe venturi : Technopolymère
- Turbine: acier inox Aisi 304 (Technopolymère JEXI 65-85-105)
- Abre de pompe: acier inox Aisi 304 (Aisi 420F JEXI 65-85-105)
- Garniture mécanique: Carbone dur – Céramique

MOTOR

Le moteurs sont asynchrones à cage d'écurieil fermés à ventilation extérieure monofásicos,

- Pour le modèles monophasé son avec protection thermique et condensateur connecté en permanence
- Pour les modèles triphasés, la protection est à la charge de l'utilisateur. A recommandé l'équipement conformément à la réglementation
- A Classe d'isolation F - service S 1 – protection IP44
- Protection IP54 dans le terminal

STAINLESS STEEL SELF-PRIMING ELECTRIC PUMPS

The self-priming centrifugal electric pumps series JEXI have been designed to pump clean water from wells, even if mixed with gas

- Maximum suction up to 8-9 m
- Liquid temperature not higher than 35 °C for domestic use (CEI EN 60335-2-41) or 60 °C for other use, while the ambient temperature must not be higher than 40 °C
- Flow rate up to ~ 4 m³/h
- Heads up to ~ 50 m

TECHNICAL FEATURES

- Pump body: stainless steel Aisi 304
- Motor bracket in die casting aluminium UNI 5076
- Diffuser, Nozzle & Venturi tube: Techno-polymer
- Impeller: stainless steel Aisi 304 (Techno-polymer JEXI 65-85-105)
- Pump shaft: stainless steel Aisi 304 (Aisi 420F JEXI 65-85-105)
- Mechanical seal: carbon-ceramics

MOTOR

The control motors are asynchronous, squirrel cage-type, closed, with external ventilation

- Incorporated motor protection and capacitor always on, for single-phase models
- The motor protection for three-phase models must be installed by the customer. Equipment compliant with current standards should be used
- Class of insulation:F-service:S1-Degree of protection: IP 44
- Terminal board protection: IP 54

ELECTROBOMBAS CENTRÍFUGAS AUTOCEBANTES INOX

Las electrobombas centrifugas autocebantes serie JEXI han sido proyectadas para aspirar aguas limpias desde pozos aun en el caso de que estén mezcladas con gas

- Aspiración hasta 8-9 m de profundidad
- Temperatura max. del líquido hasta 35 °C para uso doméstico (CEI EN 60335-2-41) o 60 °C para otros usos y temperatura ambiente hasta 40 °C
- Caudal hasta ~ 4 m³/h.
- Alturas hasta ~ 50 m.

CARACTERÍSTICAS DE CONSTRUCCIÓN

- Cuerpo de bomba: de acero Inox AISI304
- Soporte: fundición de aluminio UNI 5076
- Difusores y el grupo venturi: De tecnopolímero
- Rodete: de acero Inox AISI304 (De tecnopolímero JEXI 65-85-105)
- Eje de la bomba: de acero Inox AISI 304 (Aisi 420F JEXI 65-85-105)
- Cierre mecánico: De cerámica y grafito

MOTOR

Los motores de accionamiento son asíncrono de jaula de ardilla cerrados, ventilados externamente

- Para los modelos monofásicos, protección térmica y condensador incorporado
- Para los modelos trifásicos de la protección se encarga el usuario y el equipo recomendado de acuerdo con las normas
- Aislamiento de Clase F – funcionamiento S1- proteccion IP44
- Proteccion IP54 para el terminal

50 Hz - min⁻¹ ~ 2900

TIPO TYPE		Potenza nominale Nominal power		Potenza assorbita Input power [W]		Condensatore Capacitor 450 V max	Corrente assorbita Input current [A]			Portata - Capacity							
Monofase Single-phase	Trifase Three-phase	kW	HP	a	b	[μF]	1~230V	3~230V	3~400V	Q [m ³ /h]	0	0,6	1,2	1,8	2,4	3	3,6
JEXI 65 M	JEXI 65 T	0,44	0,6	700	680	12,5	3,1	2,4	1,4	Q [l/1']	0	10	20	30	40	50	60
JEXI 85 M	-	0,59	0,8	900	-	14	4,3	-	-	Prevalenza (m C.A.) Total head (m W.C.)							
JEXI 105 M	JEXI 105 T	0,74	1	1020	1250	16	4,6	3,6	2,3	H [m]	36,1	29,0	23,3	19,0	16,1		
JEXI 101 M	JEXI 101 T	0,74	1	920	930	16	4,3	3,6	2,3		47,2	39,8	33,4	27,8	15,3		
JEXI 121 M	JEXI 121 T	0,88	1,2	1110	1040	25	6,3	4,7	2,7		48,1	43,0	35,0	30,2	25,0	10	
											46,2	39,1	33,0	27,9	23,9	20,9	18,9
											51,3	45,9	41,4	36,4	31,8	27,3	23,0

a) ~ Monofase 230 V

b) ~ Trifase 230/400 V

60 Hz - min⁻¹ ~ 3400

TIPO TYPE		Potenza nominale Nominal power		Potenza assorbita Input power [W]		Condensatore Capacitor 450 V max	Corrente assorbita Input current [A]				Portata - Capacity							
Monofase Single-phase	Trifase Three-phase	kW	HP	a	b	[μF]	1~115 V	1~220 V	3~220 V	3~380 V	Q [m ³ /h]	0	0,6	1,2	1,8	2,4	3	3,6
JEXI 65 M	-	0,44	0,6	710	-	14	7	3,3	-	-	Q [l/1']	0	10	20	30	40	50	60
JEXI 105 M	JEXI 105 T	0,74	1	1230	700	20	11,7	5,5	2,9	1,6	Prevalenza (m C.A.) Total head (m W.C.)							
											H [m]	40,5	34,8	28,0	23,3	5,4		
												38,4	36,4	33,4	29,5	24,8	19,1	12,5

a) ~ Monofase 115/220 V

b) ~ Trifase 220/380 V

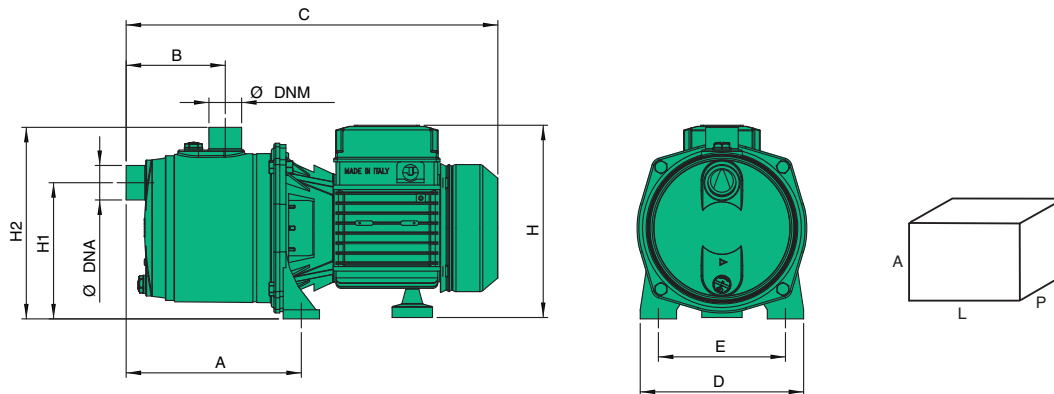

TIPO TYPE	DIMENSIONI [mm] DIMENSIONS [mm]										IMBALLO [mm] PACKING [mm]			PESO WEIGHT [kg]
	A	B	C	D	E	H	H1	H2	DNA	DNM	A	L	P	
JEXI 65	180	95	370	180	140	194	155	200	1"	1"	250	440	200	7,6
JEXI 85	180	95	390	180	140	204	155	200	1"	1"	250	440	200	9
JEXI 105	180	95	390	180	140	204	155	200	1"	1"	250	440	200	9,8
JEXI 101	210	118	428	180	140	204	155	200	1"	1"	250	440	200	10
JEXI 121	210	118	428	180	140	204	155	200	1"	1"	250	440	200	11,2

min⁻¹ ~ 2900

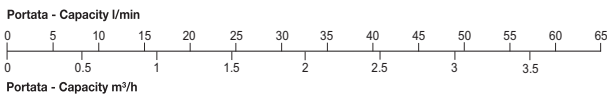
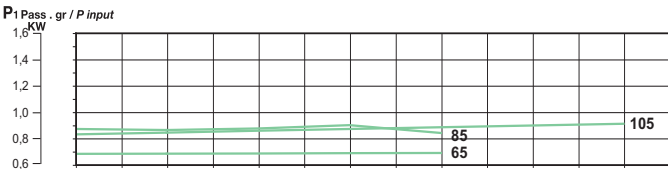
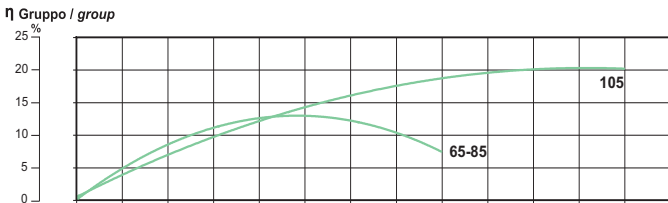
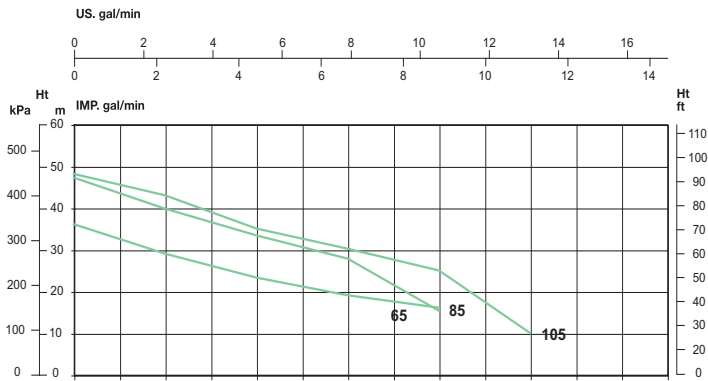

min⁻¹ ~ 3400

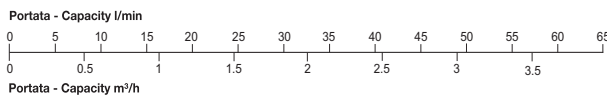
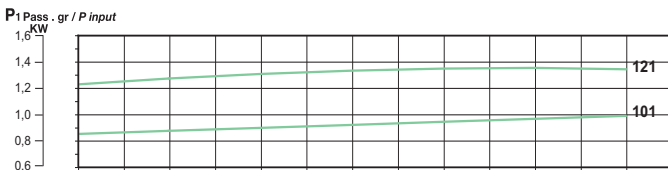
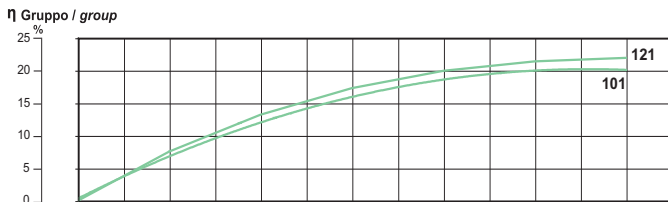
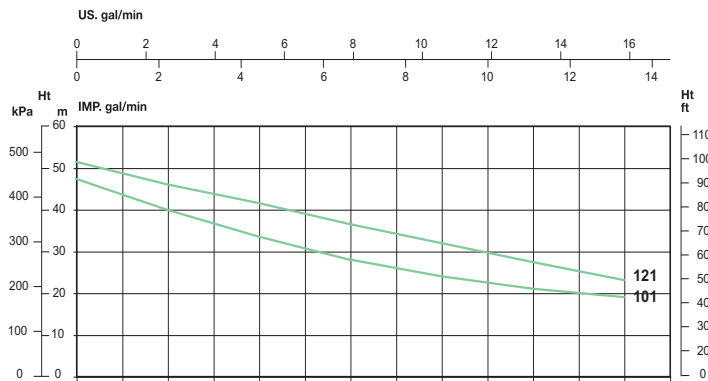
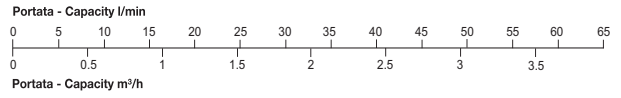
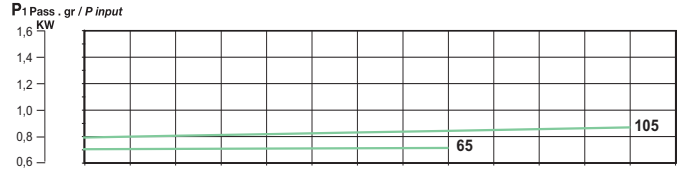
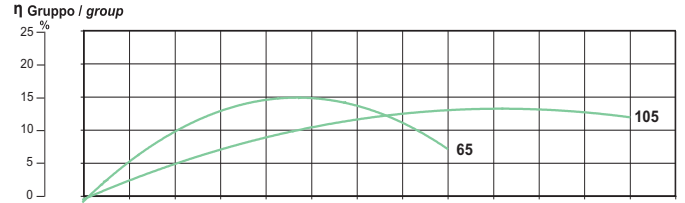
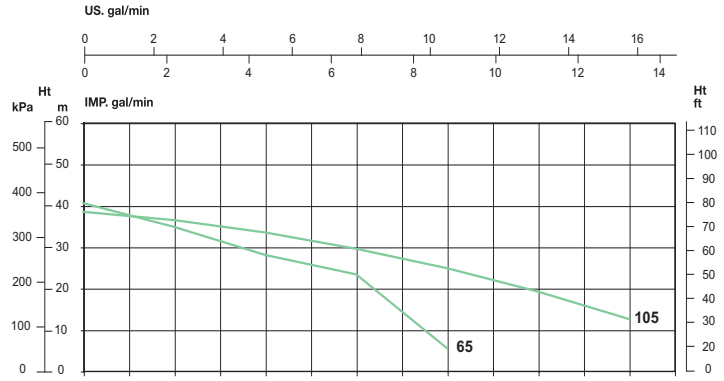

"JB"



NOMENCLATURA PARTI DI RICAMBIO
SPARE PARTS LIST
NOMENCLATURE PIECES DE RECHANGE
NOMENCLATURA REPUESTOS

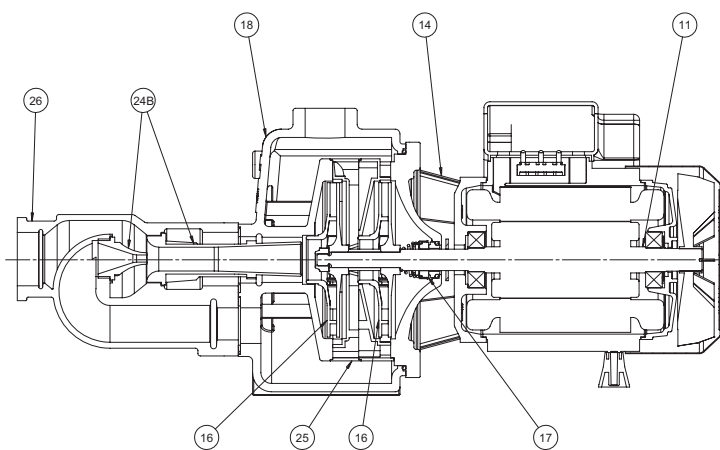

- 11** Albero con rotore – Pump shaft + rotor
Arbre + rotor – Eje rotor
- 14** Supporto mandata – Outlet bracket
Support envoyée – Soporte entrega
- 16** Girante – Impeller
Turbine – Impulsor
- 17** Tenuta meccanica – Mechanical seal
Garniture mécanique – Cierre mecánico
- 18** Corpo pompa – Pump body
Corp de pompe – Cuerpo bomba
- 24B** Ugello e venturi – Nozze & venturi
Gicleur et venturi – Tobera y venturi
- 25** Diffusore – Diffuser
Diffuseur – Difusor
- 26** Eiettore – Ejector
Ejectuer – Eyector

ELETTROPOMPE AUTOADESCANTI BIGIRANTI

Le elettropompe centrifughe autoadescenti serie JB sono state progettate per aspirare acque pulite da pozzi anche se miscelate a gas

- Aspirazione fino a 8-9 m di profondità
- Temperatura max. del liquido fino a 35 °C per uso domestico (CEI EN 60335-2-41) o 60 °C per altri usi e temperatura ambiente fino a 40 °C
- Portate fino a ~ 9 m³/h.
- Prevalenze fino a ~ 60 m.

CARATTERISTICHE COSTRUTTIVE

- Corpo pompa: ghisa G20 con trattamento anticorrosione
- Supporto motore: ghisa G20 con trattamento anticorrosione
- Diffusori, Ugello e Venturi: Tecnopolimero
- Giranti: Tecnopolimero (ottone stampato UNI-EN 12165 disponibile a richiesta)
- Albero pompa: acciaio inox Aisi 304
- Tenuta meccanica: carbone-ceramica

MOTORE

I motori di comando sono del tipo asincrono a gabbia di scoiattolo chiusi, a ventilazione esterna

- Motoprotettore incorporato e condensatore permanentemente inserito per i tipi monofasi
- La protezione del motore nella versione trifase è a cura del cliente e si raccomandano apparecchiature in accordo con le norme vigenti
- Isolamento classe F – servizio S1- grado di protezione IP 44
- Protezione morsettiera IP 54

ÉLETTROPOMPES AUTOAMORÇANTES À DEUX ROUES

Les électropompes centrifuges autoamorçantes série JB ont été conçues pour aspirer des eaux propres de puits même mélangées à du gaz

- Aspiration jusqu'à 8-9 m de profondeur
- Température max. du liquide jusqu'à 35 °C pour utilisation domestique (CEI EN 60335-2-41) o 60 °C pour d'autres utilisations e température ambiante jusqu'à 40 °C
- Plage d'utilisation jusqu'à ~ 9 m³/h.
- Hauteur manométrique jusqu'à ~ 60 m.

CARACTERISTIQUES DE CONSTRUCTION

- Corps de pompe : En fonte G20 avec traitement anti-corrosion
- Lanterne: En fonte G20 avec traitement anti-corrosion
- Diffuseurs, et groupe venturi: Technopolymère
- Turbine: Technopolymère (laiton étampé UNI-EN 12165 sur demande)
- Abre de pompe: acier inox Aisi 304
- Garniture mécanique: Carbone dur - Céramique

MOTOR

Le moteurs sont asynchrones à cage d'écuriel fermés à ventilation extérieure monofasés,

- Pour le modèles monophasés son avec protection thermique et condensateur connecté en permanence
- Pour les modèles triphasés, la protection est à la charge de l'utilisateur. A recommandé l'équipement conformément à la réglementation
- A Classe d'isolation F - service S 1 – protection IP44
- Protection IP54 dans le terminal

SELF-PRIMING ELECTRIC PUMPS 2 IMPELLERS

The self-priming centrifugal electric pumps series JB have been designed to pump clean water from wells, even if mixed with gas

- Maximum suction up to 8-9 m
- Liquid temperature not higher than 35 °C for domestic use (CEI EN 60335-2-41) or 60 °C for other use, while the ambient temperature must not be higher than 40 °C
- Flow rate up to ~ 9 m³/h
- Heads up to ~ 60 m

TECHNICAL FEATURES

- Pump body: cast iron G20 with anti-corrosive coating Motor bracket in die casting aluminium UNI 5076
- Diffusers, Nozzle & Venturi tube: Techno-polymer
- Impellers: Techno-polymer (stamped brass UNI-EN 12165 available on demand)
- Pump shaft:: stainless steel Aisi 304
- Mechanical seal: carbon-ceramics

MOTOR

The control motors are asynchronous, squirrel cage-type, closed, with external ventilation

- Incorporated motor protection and capacitor always on, for single-phase models
- The motor protection for three-phase models must be installed by the customer. Equipment compliant with current standards should be used
- Class of insulation:F-service:S1-Degree of protection: IP 44
- Terminal board protection: IP 54

ELECTROBOMBAS AUTOCEBANTES CON DOBLE IMPULSOR

Las electrobombas centrifugas autocebantes serie JB han sido proyectadas para aspirar aguas limpias desde pozos aun en el caso de que éstas estén mezcladas con gas.

- Aspiración hasta 8-9 m de profundidad
- Temperatura max. del líquido hasta 35 °C para uso doméstico (CEI EN 60335-2-41) o 60 °C para otros usos y temperatura ambiente hasta 40 °C
- Caudal hasta ~ 9 m³/h.
- Alturas hasta ~ 60 m.

CARACTERISTICAS DE CONSTRUCCIÓN

- Cuerpo de bomba: Fundición gris G20 con tratamiento contra-corrosión
- Soporte: Fundición gris G20 con tratamiento contra-corrosión
- Difusores y el grupo venturi: De tecnopolimero
- Rodetes: De tecnopolimero (De latón UNI-EN12165 bajo petición)
- Eje de la bomba: de acero Inox AISI304
- Cierre mecánico: De cerámica y grafito

MOTOR

Los motores de accionamiento son asíncrono de jaula de ardilla cerrados, ventilados externamente

- Para los modelos monofásicos, protección térmica y condensador incorporado
- Para los modelos trifásicos de la protección se encarga el usuario y el equipo recomendado de acuerdo con las normas
- Aislamiento de Clase F – funcionamiento S1- protección IP44
- Protección IP54 para el terminal

50 Hz - min⁻¹ ~ 2900

TIPO TYPE	Potenza nominale Nominal power	Potenza assorbita Input power [W]	Condensatore Capacitor 450 V max	Corrente assorbita Input current [A]	Portata - Capacity																		
					Q [m ³ /h]	0	0,6	1,2	1,8	2,4	3	3,6	4,2	4,8	5,4	6	6,6	7,2	7,8	8,4	9		
Monofase Single-phase						Q [l/s]	0	10	20	30	40	50	60	70	80	90	100	110	120	130	140	150	
						Prevalenza (m C.A.) Total head (m W.C.)																	
a	b	kW	HP	a	b	[μF]	1~230V	3~230V	3~400V														
JB 150 M	JB 150 T	1,1	1,5	1830	1960	31,5	8,3	7,1	4,2	H [m]	64,0	62,7	60,4	57,3	53,3	48,5	42,8	36,2	28,7				
JB 200 M	JB 200 T	1,47	2	2200	2200	40	9,8	6,9	4	H [m]	60,9	59,9	58,7	57,2	55,4	53,3	51,0	48,4	45,5	42,3	38,9	35,7	31,3
-	JB 300 T	2,2	3	-	3100	-	-	9,3	5,4	H [m]	60,1	59,4	58,6	57,7	56,6	55,3	53,9	52,3	50,5	48,6	46,5	44,3	41,9

a) ~ Monofase 230 V

b) ~ Trifase 230/400 V

60 Hz - min⁻¹ ~ 3400

TIPO TYPE	Potenza nominale Nominal power	Potenza assorbita Input power [W]	Condensatore Capacitor 450 V max	Corrente assorbita Input current [A]	Portata - Capacity																		
					Q [m ³ /h]	0	0,6	1,2	1,8	2,4	3	3,6	4,2	4,8	5,4	6	6,6	7,2	7,8	8,4	9		
Monofase Single-phase						Q [l/s]	0	10	20	30	40	50	60	70	80	90	100	110	120	130	140	150	
						Prevalenza (m C.A.) Total head (m W.C.)																	
a	b	kW	HP	a	b	[μF]	1~220V	3~220V	3~380V														
JB 150 M	JB 150 T	1,1	1,5	2010	1350	31,5	9,4	5,6	3,1	H [m]	64,2	63,9	62,8	60,9	58,3	54,8	50,5	45,4	39,5	32,9	25,4		
JB 200 M	JB 200 T	1,47	2	2280	1550	40	10,5	6,4	3,6	H [m]	59,7	58,2	56,6	54,8	52,7	50,5	48,0	45,4	42,5	39,5	36,2	32,8	29,1

a) ~ Monofase 220 V

b) ~ Trifase 220/380 V

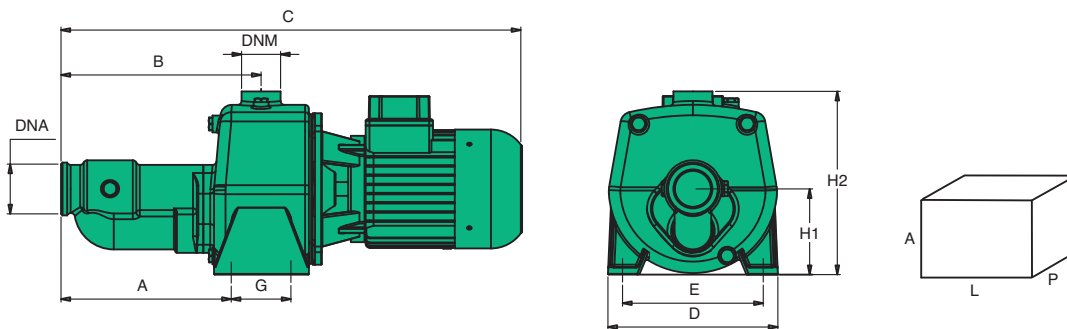

TIPO TYPE	DIMENSIONI [mm] DIMENSIONS [mm]										IMBALLO [mm] PACKING [mm]			PESO WEIGHT [kg]
	A	B	C	D	E	G	H1	H2	DNA	DNM	A	L	P	
JB 150	209	257	596	266	174	104	120	248	1"1/2	1"	290	610	250	29.8
JB 200	209	257	596	266	174	104	120	248	1"1/2	1"	290	610	250	33.8
JB 300	209	257	596	266	174	104	120	248	1"1/2	1"	290	610	250	34.8

min⁻¹ ~ 2900

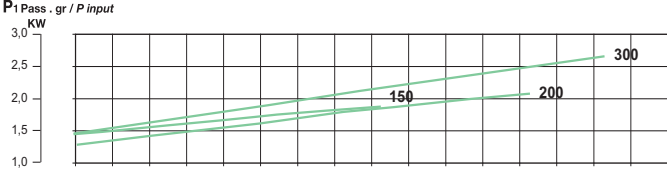
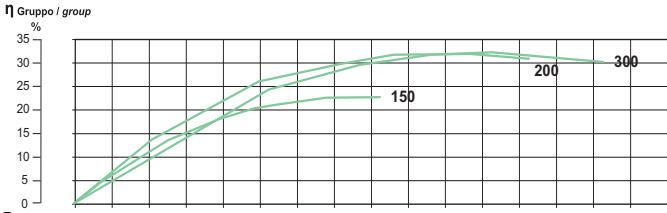
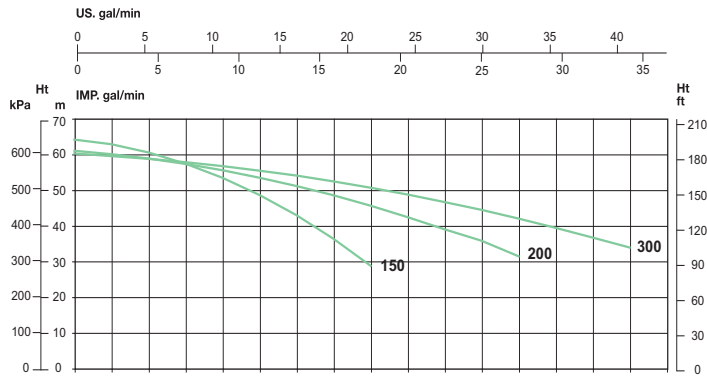

Portata - Capacity l/min
0 20 40 60 80 100 120 140 160

Portata - Capacity m³/h
0 1 2 3 4 5 6 7 8 9 10

min⁻¹ ~ 3400

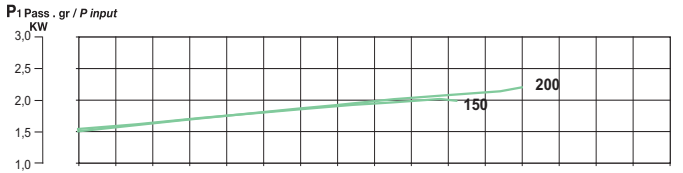
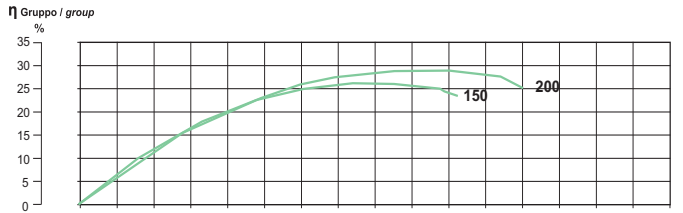
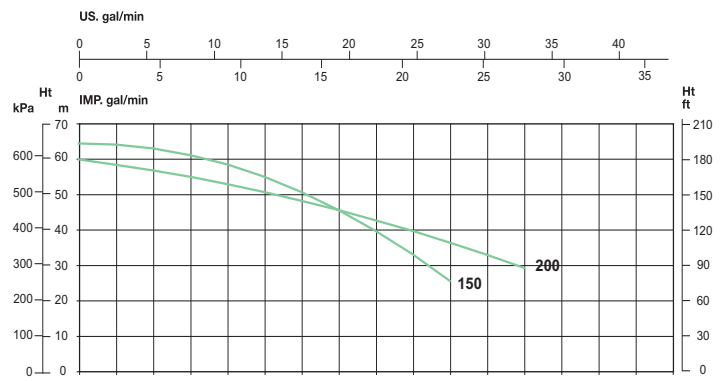

Portata - Capacity l/min
0 20 40 60 80 100 120 140 160

Portata - Capacity m³/h
0 1 2 3 4 5 6 7 8 9 10

"JAP"



NOMENCLATURA PARTI DI RICAMBIO
SPARE PARTS LIST
NOMENCLATURE PIÈCES DE RECHANGE
NOMENCLATURA REPUESTOS

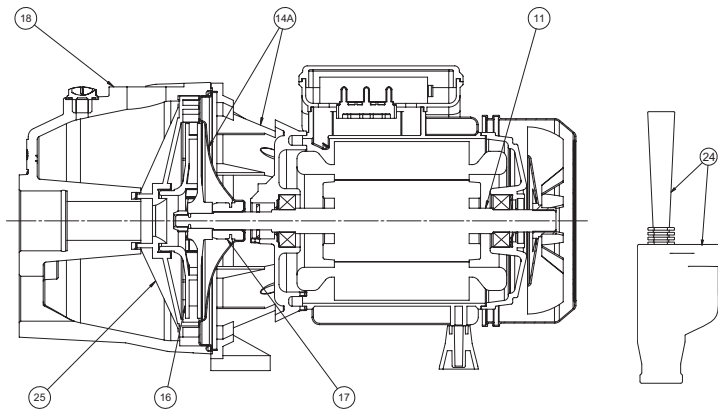

- 11** Albero con rotore – Pump shaft + rotor
Arbre + rotor – Eje rotor
- 14A** Kit supporto – Motor bracket kit
Kit support – Kit soporte
- 16** Girante – Impeller
Turbine – Impulsor
- 17** Tenuta meccanica – Mechanical seal
Garniture mécanique – Cierre mecánico
- 18** Corpo pompa – Pump body
Corp de pompe – Cuerpo bomba
- 24** Eiettore completo – Complete ejector
Ejecteur complet – Ejector completo
- 25** Diffusore – Diffuser
Diffuseur – Difusor

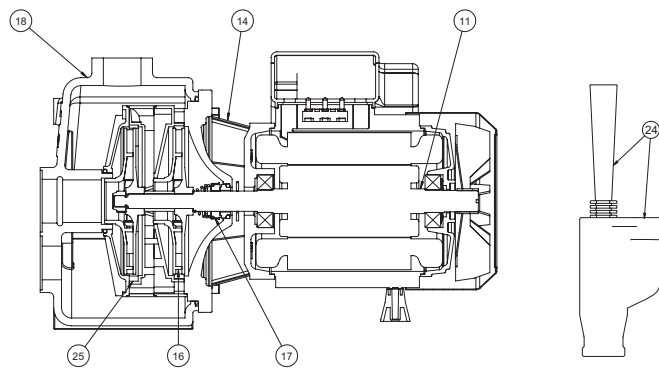

- 11** Albero con rotore – Pump shaft + rotor
Arbre + rotor – Eje rotor
- 14** Supporto mandata – Outlet bracket
Support envoyée – Soporte entrega
- 16** Girante – Impeller
Turbine – Impulsor
- 17** Tenuta meccanica – Mechanical seal
Garniture mécanique – Cierre mecánico
- 18** Corpo pompa – Pump body
Corp de pompe – Cuerpo bomba
- 24** Eiettore completo – Complete ejector
Ejecteur complet – Ejector completo
- 25** Diffusore – Diffuser
Diffuseur – Difusor

ELETTROPOMPE PER PROFONDA ASPIRAZIONE

Le elettropompe centrifughe autoadescenti per aspirazione profonda serie JAP sono state progettate per pompare acque pulite da pozzi di almeno 4" quando il livello dell'acqua supera gli 8 m di profondità

- Temperatura max. del liquido fino a 35 °C per uso domestico (CEI EN 60335-2-41) o 60 °C per altri usi e temperatura ambiente fino a 40 °C.
- Portate fino a ~ 3,6 m³/h.
- Prevalenze fino a ~ 50 m.

CARATTERISTICHE COSTRUTTIVE

- Corpo pompa: ghisa G20 con trattamento anticorrosione
- Supporto motore: alluminio pressofuso UNI 5076 (ghisa per JAP150-200)
- Eiettore: ghisa G20 con trattamento anticorrosione
- Diffusori, Ugello e Venturi: Tecnopolimero
- Giranti: tecnopolimero (ottone stampato UNI-EN 12165 disponibile a richiesta)
- Albero pompa: acciaio inox Aisi 304 (Aisi 420 F per JAP 80-100)
- Tenuta meccanica: carbone-ceramica

MOTORE

I motori di comando sono del tipo asincrono a gabbia di scoiattolo chiusi, a ventilazione esterna

- Motoprotettore incorporato e condensatore permanentemente inserito per i tipi monofasi
- La protezione del motore nella versione trifase è a cura del cliente e si raccomandano apparecchiature in accordo con le norme vigenti
- Isolamento classe F –servizio S1- grado di protezione IP 44
- Protezione morsettiera IP 54

ÉLECTROPOMPES POUR ASPIRATION EN PROFONDEUR

Les électropompes centrifuges autoamorçantes pour aspiration en profondeur série JAP ont été conçues pour pomper des eaux propres de puits d'au moins 4" quand le niveau de l'eau dépasse les 8 m de profondeur

- Température max. du liquide jusqu'à 35 °C pour utilisation domestique (CEI EN 60335-2-41) ou 60 °C pour d'autres utilisations et température ambiante jusqu'à 40 °C.
- Plage d'utilisation jusqu'à ~ 3,6 m³/h.
- Hauteur manométrique jusqu'à ~ 50 m.

CARACTERISTIQUES DE CONSTRUCTION

- Corps de pompe : En fonte G20 avec traitement anti-corrosion
- Lanterne: aluminium moulé sur pression UNI 5076 (en fonte pour JAP150-200)
- Ejecteur: En fonte G20 avec traitement anti-corrosion
- Diffuseurs et groupe venturi : Technopolymère
- Turbine: Technopolymère (laiton étampé UNI-EN 12165 sur demande)
- Abre de pompe: acier inox Aisi 304 (Aisi 420 F pour JAP 80-100)
- Garniture mécanique: Carbone dur - Céramique

MOTOR

Le moteurs sont asynchrones à cage d'écuriel fermés à ventilation extérieure monofasiques,

- Pour les modèles monophasés son avec protection thermique et condensateur connecté en permanence
- Pour les modèles triphasés, la protection est à la charge de l'utilisateur. A recommandé l'équipement conformément à la réglementation
- A Classe d'isolation F - service S 1 – protection IP44
- Protection IP54 dans le terminal

DEEP SUCTION ELECTRIC PUMPS

The self-priming centrifugal deep suction electric pumps series JAP have been designed to pump clean water from wells of at least 4" when the water level is more than 8 m deep

- Liquid temperature not higher than 35 °C for domestic use (CEI EN 60335-2-41) or 60 °C for other use, while the ambient temperature must not be higher than 40 °C
- Flow rate up to ~ 3,6 m³/h
- Heads up to ~ 50 m

TECHNICAL FEATURES

- Pump body: cast iron G20 with anti-corrosive coating
- Motor bracket: in die casting aluminium UNI 5076 (cast iron for JAP 150-200)
- Ejector: cast iron G20 with anti-corrosive coating
- Diffusers, Nozzle & Venturi tube: Techno-polymer
- Impellers: polymer (stamped brass UNI-EN 12165 on demand)
- Pump shaft: stainless steel Aisi 304 (Aisi 420 F for JAP 80-100)
- Mechanical seal: carbon-ceramics

MOTOR

The control motors are asynchronous, squirrel cage-type, closed, with external ventilation

- Incorporated motor protection and capacitor always on, for single-phase models
- The motor protection for three-phase models must be installed by the customer. Equipment compliant with current standards should be used
- Class of insulation:F-service:S1-Degree of protection: IP 44
- Terminal board protection: IP 54

ELECTROBOMBAS PARA ASPIRACIÓN PROFUNDA

Las electrobombas centrifugas autocebadas para aspiración profunda serie JAP han sido proyectadas para bombear aguas limpias desde pozos de al menos 4" cuando el nivel del agua supera los 8 m de profundidad.

- Temperatura max. del líquido hasta 35 °C para uso doméstico (CEI EN 60335-2-41) o 60 °C para otros usos y temperatura ambiente hasta 40 °C.
- Caudal hasta ~3,6 m³/h.
- Alturas hasta ~ 50 m.

CARACTERÍSTICAS DE CONSTRUCCIÓN

- Cuerpo de bomba: Fundición gris G20 con tratamiento contra-corrosión
- Soporte: fundición de aluminio UNI 5076 (Fundición gris G20 para las JAP150-200)
- Inyector: Fundición gris G20 con tratamiento contra-corrosión
- Difusores y el grupo venturi: De tecnopolimero
- Rodetes: De tecnopolimero (De latón UNI-EN 12165 bajo petición)
- Eje de la bomba: de acero Inox AISI304 (Aisi 420 F para las JAP 80-100)
- Cierre mecánico: De cerámica y grafito

MOTOR

Los motores de accionamiento son asíncrono de jaula de ardilla cerrados, ventilados externamente

- Para los modelos monofásicos, protección térmica y condensador incorporado
- Para los modelos trifásicos de la protección se encarga el usuario y el equipo recomendado de acuerdo con las normas
- Aislamiento de Clase F – funcionamiento S1- protección IP44
- Protección IP54 para el terminal

50 Hz - min⁻¹ ~ 2900

TIPO TYPE		Potenza nominale Nominal power		Potenza assorbita Input power [W]		Condensatore Capacitor 450 V max	Corrente assorbita Input current [A]			Tipo eiettore Ejector	Aspirazione Suction depth [m]	Portata - Capacity											
Monofase Single-phase	Trifase Three-phase	kW	HP	a	b	[μF]	1~230V	3~230V	3~400V			Q [m ³ /h]	0.18	0.36	0.6	0.9	1.2	1.5	1.8	2.1	3	3.6	
a	b											Q [l/s]	3	6	10	15	20	25	30	35	50	60	
												Prevalenza (m C.A.) Total head (m W.C.)											
JAP 80 M	JAP 80 T	0.59	0.8	870	890	14	3.9	2.6	1.5	E20	15	31	28	25	22	19	17	15					
										E30	20	28	25	22	15								
JAP 100 M	JAP 100 T	0.74	1	930	970	16	4.1	3.1	1.8	E20	15	40	38	36	31	28	24	20					
										E30	20	38	36	32	26	21	17						
JAP 150 M	JAP 150 T	1.1	1.5	1800	1910	31,5	7.9	6.1	3.5	E20	15								37	32	25	17	
										E30	20							40	30	27	20		
JAP 200 M	JAP 200 T	1.47	2	2340	2100	40	10.3	6.6	3.8	E20	15												
										E30	20												

a) ~ Monofase 230 V

b) ~ Trifase 230/400 V

60 Hz - min⁻¹ ~ 3400

TIPO TYPE		Potenza nominale Nominal power		Potenza assorbita Input power [W]		Condensatore Capacitor 450 V max	Corrente assorbita Input current [A]			Tipo eiettore Ejector	Aspirazione Suction depth [m]	Portata - Capacity											
Monofase Single-phase	Trifase Three-phase	kW	HP	a	b	[μF]	1~220V	3~220V	3~380V			Q [m ³ /h]	0.18	0.36	0.6	0.9	1.2	1.5	1.8	2.1	3	3.6	
a	b											Q [l/s]	3	6	10	15	20	25	30	35	50	60	
												Prevalenza (m C.A.) Total head (m W.C.)											
JAP 80 M	JAP 80 T	0.59	0.8	870	890	14	3.9	2.6	1.5	E20	15	31	28	25	22	19	17	15					
										E30	20	28	25	22	15								
JAP 100 M	JAP 100 T	0.74	1	930	970	16	4.1	3.1	1.8	E20	15	40	38	36	31	28	24	20					
										E30	20	38	36	32	26	21	17						
JAP 150 M	JAP 150 T	1.1	1.5	1800	1910	31,5	7.9	6.1	3.5	E20	15								37	32	25	17	
										E30	20							40	30	27	20		
JAP 200 M	JAP 200 T	1.47	2	2340	2100	40	10.3	6.6	3.8	E20	15												
										E30	20												

a) ~ Monofase 220 V

b) ~ Trifase 220/380 V

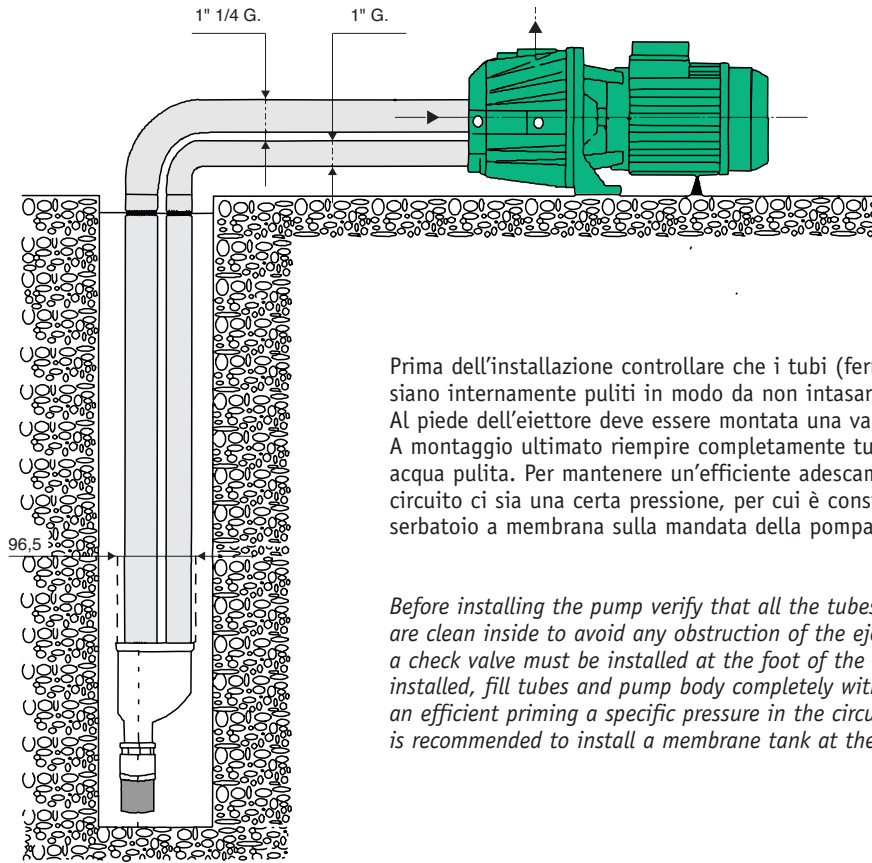

Prima dell'installazione controllare che i tubi (ferro, plastica o gomma) siano internamente puliti in modo da non intasare l'ugello dell'eiettore. Al piede dell'eiettore deve essere montata una valvola di fondo o di ritegno. A montaggio ultimato riempire completamente tubi e corpo pompa con acqua pulita. Per mantenere un'efficiente adescamento è necessario che nel circuito ci sia una certa pressione, per cui è consigliabile montare un serbatoio a membrana sulla mandata della pompa.

Before installing the pump verify that all the tubes (iron, plastic or rubber) are clean inside to avoid any obstruction of the ejector nozzle. A foot valve or a check valve must be installed at the foot of the ejector. After the pump is installed, fill tubes and pump body completely with clean water. To preserve an efficient priming a specific pressure in the circuit is necessary, therefore it is recommended to install a membrane tank at the delivery of the pump.

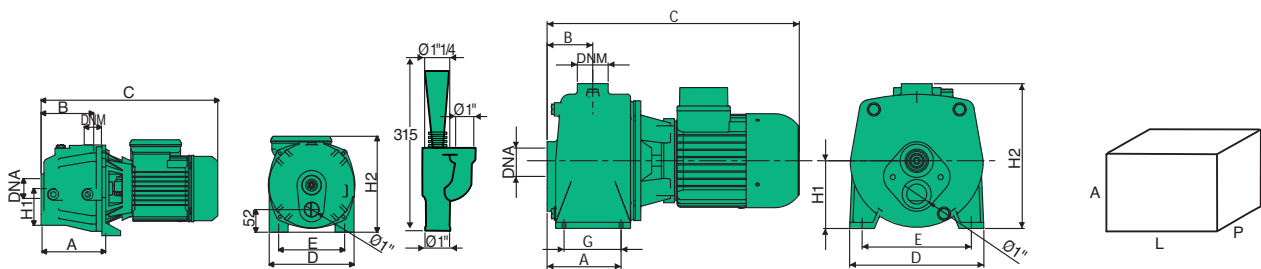

TIPO TYPE	DIMENSIONI [mm] DIMENSIONS [mm]									IMBALLO [mm] PACKING [mm]			PESO WEIGHT [kg]	
	A	B	C	D	E	G	H1	H2	DNA	DNM	A	L		P
JAP 80	160	85	370	180	140	-	100	188	1"1/4	1"	250	450	190	14.2
JAP 100	160	85	370	180	140	-	100	188	1"1/4	1"	250	450	190	14.8
JAP 150	125	74	415	226	174	104	120	248	1"1/4	1"	350	450	250	30
JAP 200	125	74	415	226	174	104	120	248	1"1/4	1"	350	450	250	32

"PA"

Electric pumps

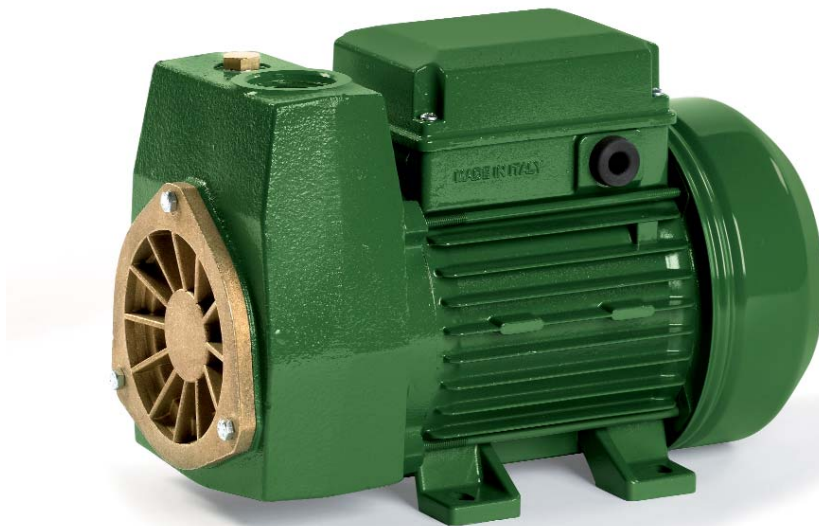

NOMENCLATURA PARTI DI RICAMBIO
SPARE PARTS LIST
NOMENCLATURE PIECES DE RECHANGE
NOMENCLATURA REPUESTOS

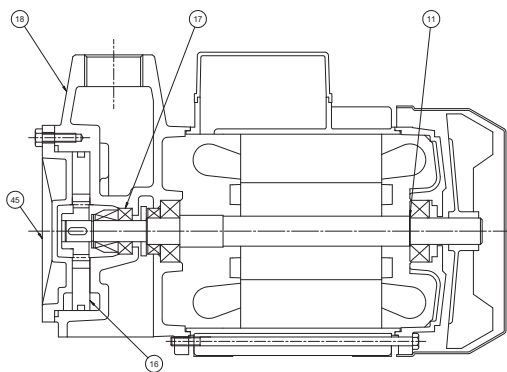

- 11** Albero con rotore – Pump shaft + rotor
Arbre + rotor – Eje rotor
- 16** Girante – Impeller
Turbine – Impulsor
- 17** Tenuta meccanica – Mechanical seal
Garniture mécanique – Cierre mecánico
- 18** Corpo pompa – Pump body
Corp de pompe – Cuerpo bomba
- 45** Coperchio corpo – Cover
Couvercle corps – Tapa cuerpo

TOP RANGE

ELETTROPOMPE AUTOADESCANTI AD ANELLO LIQUIDO

Le elettropompe della serie PA sono autoadescenti ad anello liquido laterale e girante stellare, sono state progettate per pompare liquidi puliti senza parti abrasive, senza corpi solidi in sospensione, non esplosivi o aggressivi per i materiali della pompa

- Temperatura max. del liquido fino a 35 °C per uso domestico (CEI EN 60335-2-41) o 90 °C per altri usi e temperatura ambiente fino a 40 °C.
- Portate fino a ~ 2.5 m³/h.
- Prevalenze fino a ~ 45 m.

CARATTERISTICHE COSTRUTTIVE

- Corpo pompa: ghisa G20 con trattamento anticorrosione
- Coperchio pompa: ottone stampato UNI-EN 12165
- Giranti: ottone stampato UNI-EN 12165
- Albero pompa: acciaio inox Aisi 420F
- Tenuta meccanica: carbone-ceramica

MOTORE

I motori di comando sono del tipo asincrono a gabbia di scoiattolo chiusi, a ventilazione esterna

- Motoprotettore incorporato e condensatore permanentemente inserito per i tipi monofasi
- La protezione del motore nella versione trifase è a cura del cliente e si raccomandano apparecchiature in accordo con le norme vigenti
- Isolamento classe F - servizio S1 - grado di protezione IP 44
- Protezione morsettiera IP 54

ÉLECTROPOMPES AUTOAMORÇANTES À ANNEAU LIQUIDE

Les électropompes de la série PA sont autoamorçantes à anneau liquide latéral et roue en étoile, ont été conçues pour pomper des liquides propres sans parties abrasives, sans corps liquides en suspension, non explosifs ou agressifs pour les matériaux de la pompe

- Température max. du liquide jusqu'à 35 °C pour utilisation domestique (CEI EN 60335-2-41) ou 90 °C pour d'autres utilisations et température ambiante jusqu'à 40 °C.
- Plage d'utilisation jusqu'à ~ 2.5 m³/h.
- Hauteur manométrique jusqu'à ~ 45 m.

CARACTERISTIQUES DE CONSTRUCTION

- Corps de pompe : En fonte G20 avec traitement anti-corrosion
- Couvercle de pompe: laiton étampé UNI-EN 12165
- Turbine: laiton étampé UNI-EN 12165
- Abre de pompe: acier inox Aisi 420F
- Garniture mécanique: Carbone dur - Céramique

MOTOR

Le moteurs sont asynchrones à cage d'écuriel fermés à ventilation extérieure monofasiques,

- Pour les modèles monophasés son avec protection thermique et condensateur connecté en permanence
- Pour les modèles triphasés, la protection est à la charge de l'utilisateur. A recommandé l'équipement conformément à la réglementation
- A Classe d'isolation F - service S 1 - protection IP44
- Protection IP54 dans le terminal

LIQUID RING SELF-PRIMING ELECTRIC PUMPS

This series PA of motor-driven pumps consists of self priming pumps with side liquid rings and stellar impeller, have been designed to pump clean liquids, without abrasives and suspended solids, non-explosive or aggressive for the pump's materials.

- Liquid temperature not higher than 35 °C for domestic use (CEI EN 60335-2-41) or 90 °C for other use, while the ambient temperature must not be higher than 40 °C
- Flow rate up to ~ 2.5 m³/h
- Heads up to ~ 45 m

TECHNICAL FEATURES

- Pump body: cast iron G20 with anti-corrosive coating
- Casing cover: stamped brass UNI- EN 12165
- Impeller: stamped brass UNI- EN 12165
- Pump shaft: stainless steel Aisi 420F
- Mechanical seal: carbon-ceramics

MOTOR

The control motors are asynchronous, squirrel cage-type, closed, with external ventilation

- Incorporated motor protection and capacitor always on, for single-phase models
- The motor protection for three-phase models must be installed by the customer. Equipment compliant with current standards should be used
- Class of insulation:F-service:S1-Degree of protection: IP 44
- Terminal board protection: IP 54

ELECTROBOMBAS AUTOCEBANTES DE ANILLO LÍQUIDO

Las electrobombas de la serie PA, autocebantes de anillo líquido lateral e impulsor estelar, han sido proyectadas para bombear líquidos limpios sin partes abrasivas, sin cuerpos sólidos en suspensión, que no sean explosivos ni agresivos para los materiales de la bomba

- Temperatura max. del líquido hasta 35 °C para uso doméstico (CEI EN 60335-2-41) o 90 °C para otros usos y temperatura ambiente hasta 40 °C.
- Caudal hasta ~ 2.5 m³/h.
- Alturas hasta ~ 45 m.

CARACTERÍSTICAS DE CONSTRUCCIÓN

- Cuerpo de bomba: Fundición gris G20 con tratamiento contra-corrosión
- Tapa delantera: De latónUNI-EN 12165
- Rodete: De latónUNI-EN 12165
- Eje de la bomba: de acero Inox AISI420F
- Cierre mecánico: De cerámica y grafito

MOTOR

Los motores de accionamiento son asíncrono de jaula de ardilla cerrados, ventilados externamente

- Para los modelos monofásicos, protección térmica y condensador incorporado
- Para los modelos trifásicos de la protección se encarga el usuario y el equipo recomendado de acuerdo con las normas
- Aislamiento de Clase F - funcionamiento S1- proteccion IP44
- Proteccion IP54 para el terminal

50 Hz - min⁻¹ ~ 2900

TIPO TYPE	Potenza nominale Nominal power		Potenza assorbita Input power [W]		Condensatore Capacitor 450 V max [μF]	Corrente assorbita Input current [A]			Portata - Capacity														
	Monofase Single-phase	Trifase Three-phase	a	b		1~230V	3~230V	3~400V	Q [m ³ /h]	0	0,6	1,2	1,8	2,1	2,4	2,7	Q [l/s]	0	10	20	30	35	40
PA 80 M	PA 80 T	0,6	0,8	980	990	14	4,5	3,2	1,8	Prevalenza (m C.A.) Total head (m W.C.)													
PA 100 M	PA 100 T	0,75	1	1160	1100	20	5,4	4,2	2,4	H [m]	40,0	35,0	29,0	21,0	16,0	10	46,0	42,0	35,0	29,0	25,0	21	16

a) ~ Monofase 230 V

b) ~ Trifase 230/400 V

60 Hz - min⁻¹ ~ 3400

TIPO TYPE	Potenza nominale Nominal power		Potenza assorbita Input power [W]		Condensatore Capacitor 450 V max [μF]	Corrente assorbita Input current [A]		Portata - Capacity														
	Monofase Single-phase		kW	HP		1~ 115 V	1~ 220 V	Q [m ³ /h]	0	0,6	1,2	1,8	2,1	2,4	2,7	Q [l/s]	0	10	20	30	35	40
PA 80 M		0,6	0,8	1150	20	10,5	5	Prevalenza (m C.A.) Total head (m W.C.)														
PA 100 M		0,75	1	1400	25	12,5	6	H [m]	41,0	33,0	25,1	17,3	13,4	9,6	5,8	50,3	42,3	33,4	23,9	18,9	13,6	8,2

a) ~ Monofase 115/220 V

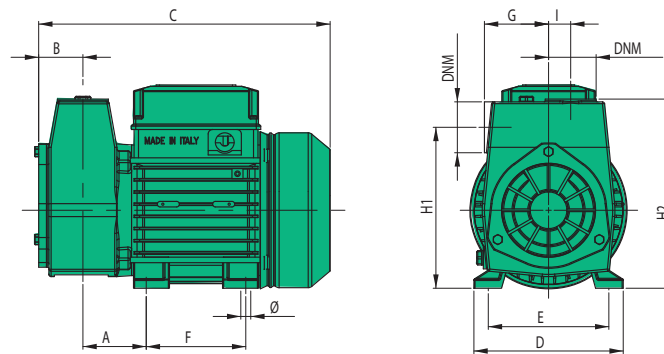

TIPO TYPE	DIMENSIONI [mm] DIMENSIONS [mm]													IMBALLO [mm] PACKING [mm]			PESO WEIGHT [kg]
	A	B	C	D	E	F	G	Ø	H1	H2	I	DNA	DNM	A	L	P	
PA 80	57	40,5	263	135	113	90	79	7	146	171	23	1"	1"	310	170	200	11,4
PA 100	57	40,5	263	135	113	90	79	7	146	171	23	1"	1"	310	170	200	12

min⁻¹ ~ 2900

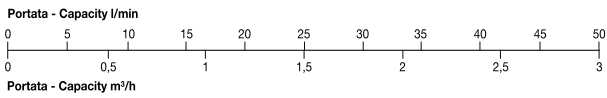
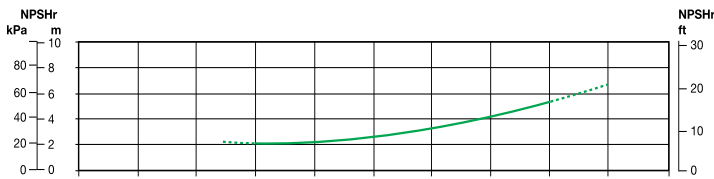
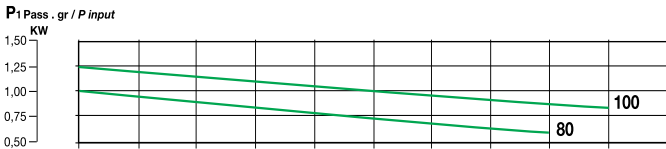
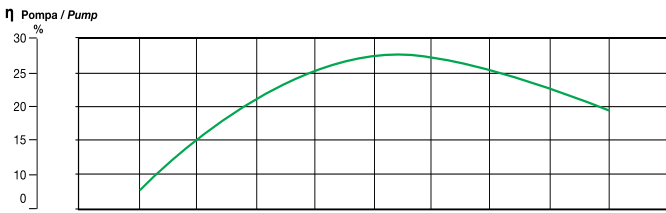
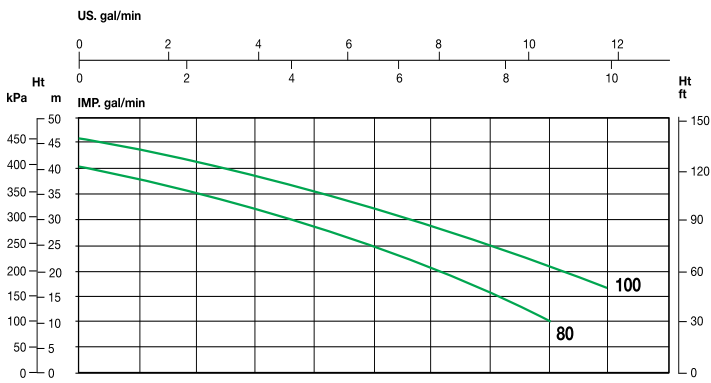

min⁻¹ ~ 3400

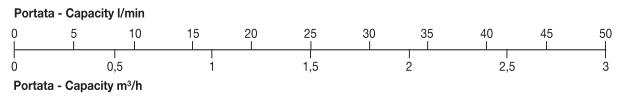
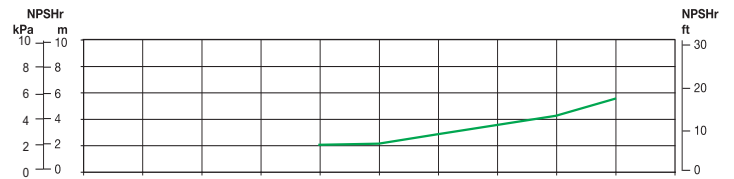
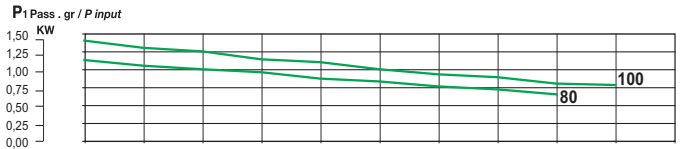
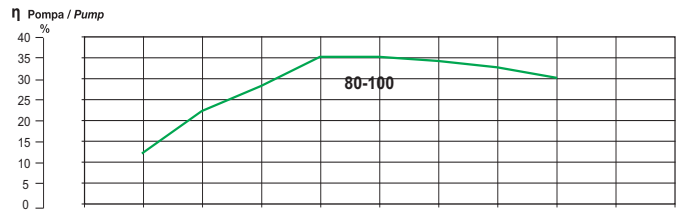
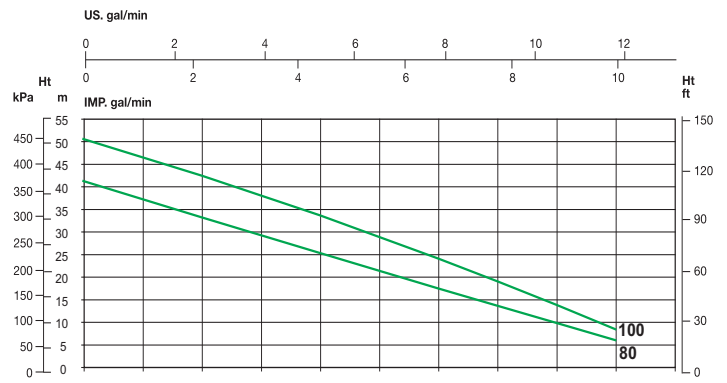

"PLA"

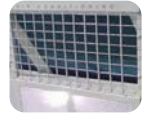

NOMENCLATURA PARTI DI RICAMBIO
SPARE PARTS LIST
NOMENCLATURE PIECES DE RECHANGE
NOMENCLATURA REPUESTOS

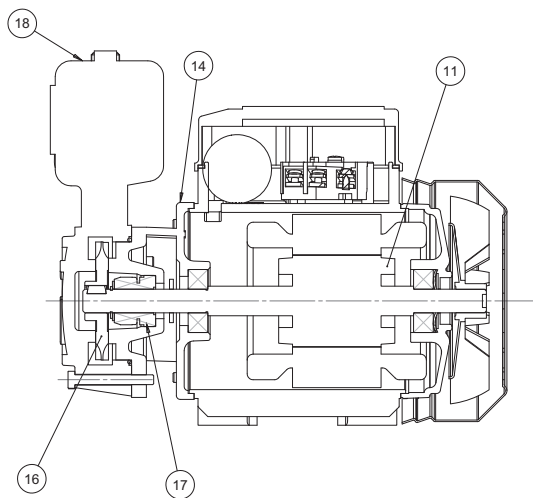

- 11** Albero con rotore – Pump shaft + rotor
Arbre + rotor – Eje rotor
- 14** Supporto mandata – Outlet bracket
Support envoyée – Soporte entrega
- 16** Girante – Impeller
Turbine – Impulsor
- 17** Tenuta meccanica – Mechanical seal
Garniture mécanique – Cierre mecánico
- 18** Corpo pompa – Pump body
Corp de pompe – Cuerpo bomba

ELETTROPOMPA MONOBLOCCO PERIFERICA AUTODESCANTE

Le elettropompe monoblocco con girante periferica della serie PLA sono state progettate per pompare liquidi puliti senza parti abrasive, senza corpi solidi in sospensione, non esplosivi o aggressivi per i materiali della pompa

- Temperatura max. del liquido fino a 35 °C per uso domestico (CEI EN 60335-2-41) o 90 °C per altri usi e temperatura ambiente fino a 40 °C.
- Portate fino a ~ 2 m³/h.
- Prevalenze fino a ~ 38 m.

CARATTERISTICHE COSTRUTTIVE

- Corpo pompa: ghisa G20 con trattamento anticorrosione in cataforesi
- Supporto motore: ghisa G20 con trattamento anticorrosione in cataforesi
- Giranti: ottone stampato UNI-EN 12165
- Albero pompa: acciaio inox Aisi 420F
- Tenuta meccanica: carbone-ceramica

MOTORE

I motori di comando sono del tipo asincrono a gabbia di scoiattolo chiusi, a ventilazione esterna

- Motoprotettore incorporato e condensatore permanentemente inserito per i tipi monofasi
- La protezione del motore nella versione trifase è a cura del cliente e si raccomandano apparecchiature in accordo con le norme vigenti
- Isolamento classe B –servizio S1- grado di protezione IP 44
- Protezione morsettiera IP 54

ÉLECTROPOMPES MONOBLOC PÉRIPHÉRIQUES AUTOMARCANES

Les électropompes monobloc à roue périphérique de la série PLA ont été conçues pour pomper des liquides propres sans parties abrasives, sans corps solides en suspension, non explosifs ou agressifs pour les matériaux de la pompe

- Température max. du liquide jusqu'à 35 °C pour utilisation domestique (CEI EN 60335-2-41) ou 90 °C pour d'autres utilisations et température ambiante jusqu'à 40 °C.
- Plage d'utilisation jusqu'à ~ 2 m³/h.
- Hauteur manométrique jusqu'à ~ 38 m.

CARACTERISTIQUES DE CONSTRUCTION

- Corps de pompe: En fonte G20 avec traitement anti-corrosion en cataphorèse
- Lanterne: En fonte G20 avec traitement anti-corrosion en cataphorèse
- Turbine: laiton estampé UNI-EN 12165
- Abre de pompe: acier inox Aisi 420F
- Garniture mécanique: Carbone dur - Céramique

MOTOR

Le moteurs sont asynchrones à cage d'écuriel fermés a à ventilation extérieure monofasés,

- Pour le modèles monophasés son avec protection thermique et condensateur connecté en permanence
- Pour les modèles triphasés, la protection est à la charge de l'utilisateur. A recommandé l'équipement conformément à la réglementation
- A Classe d'isolation B - service S 1 – protection IP44
- Protection IP54 dans le terminal

CLOSE COUPLED PERIPHERAL SELF-PRIMING PUMPS

The close-coupled pumps with peripheral impeller series PLA have been designed to pump clean liquids, without abrasives and suspended solids, non-explosive or aggressive for the pump's materials

- Liquid temperature not higher than 35 °C for domestic use (CEI EN 60335-2-41) or 90 °C for other use, while the ambient temperature must not be higher than 40 °C
- Flow rate up to ~ 2 m³/h
- Heads up to ~ 38 m

TECHNICAL FEATURES

- Pump body: cast iron G20 with anti-corrosive cathoretic treatment
- Motor bracket: cast iron G20 with anti-corrosive cathoretic treatment
- Impeller: stamped brass UNI- EN 12165
- Pump shaft: stainless steel Aisi 420F
- Mechanical seal: carbon-ceramics

MOTOR

The control motors are asynchronous, squirrel cage-type, closed, with external ventilation

- Incorporated motor protection and capacitor always on, for single-phase models
- The motor protection for three-phase models must be installed by the customer. Equipment compliant with current standards should be used
- Class of insulation: B -service:S1-Degree of protection :IP 44
- Terminal board protection: IP 54

ELECTROBOMBAS MONOBLOQUE PERIFÉRICAS

Las electrobombas monobloque con impulsor periférico de la serie PLA han sido proyectadas para bombear líquidos limpios sin partes abrasivas, sin cuerpos sólidos en suspensión, que no sean explosivos ni agresivos para los materiales de la bomba.

- Temperatura max. del líquido hasta 35 °C para uso doméstico (CEI EN 60335-2-41) o 90 °C para otros usos y temperatura ambiente hasta 40 °C.
- Caudal hasta ~ 2 m³/h.
- Alturas hasta ~ 38 m.

CARACTERÍSTICAS DE CONSTRUCCIÓN

- Cuerpo de bomba: Fundición gris G20 con tratamiento contra-corrosión en cataforesis,
- Soporte: Fundición gris G20 con con tratamiento contra-corrosión en cataforesis
- Rodete: De latón UNI-EN 12165
- Eje de la bomba: de acero Inox AISI420F
- Cierre mecánico: De cerámica y grafito

MOTOR

Los motores de accionamiento son asíncrono de jaula de ardilla cerrados, ventilados externamente

- Para los modelos monofásicos, protección térmica y condensador incorporado
- Para los modelos trifásicos de la protección se encarga el usuario y el equipo recomendado de acuerdo con las normas
- Aislamiento de Clase B – funcionamiento S1- protección IP44
- Protección IP54 para el terminal

50 Hz - min⁻¹ ~ 2900

TIPO TYPE		Potenza nominale Nominal power		Potenza assorbita Input power [W]		Condensatore Capacitor 450 V max	Corrente assorbita Input current [A]			Portata - Capacity							
Monofase Single-phase	Trifase Three-phase	kW	HP	a	b	[μF]	1~230V	3~230V	3~400V	Q [m ³ /h]	0	0,3	0,6	0,9	1,2	1,5	1,8
PLA 50 M	-	0,37	0,5	560	-	10	2,4	-	-	Q [l/s]	0	5	10	15	20	25	30
										Prevalenza (m C.A.) Total head (m W.C.)							
										H [m]	37,0	33,4	29,4	25,2	20,7	10,7	5,3

a) ~ Monofase 230 V

b) ~ Trifase 230/400 V

60 Hz - min⁻¹ ~ 3400

TIPO TYPE		Potenza nominale Nominal power		Potenza assorbita Input power [W]		Condensatore Capacitor 450 V max	Corrente assorbita Input current [A]				Portata - Capacity							
Monofase Single-phase	Trifase Three-phase	kW	HP	a	b	[μF]	1~115 V	1~220 V	3~220 V	3~380 V	Q [m ³ /h]	0	0,3	0,6	0,9	1,2	1,5	1,8
PLA 50 M	-	0,37	0,5	722	-	-	6,7	3,2	-	-	Q [l/s]	0	5	10	15	20	25	30
										Prevalenza (m C.A.) Total head (m W.C.)								
										H [m]	35,5	32,9	29,9	26,5	22,8	18,6	14,6	

a) ~ Monofase 115/220 V

b) ~ Trifase 220/380 V

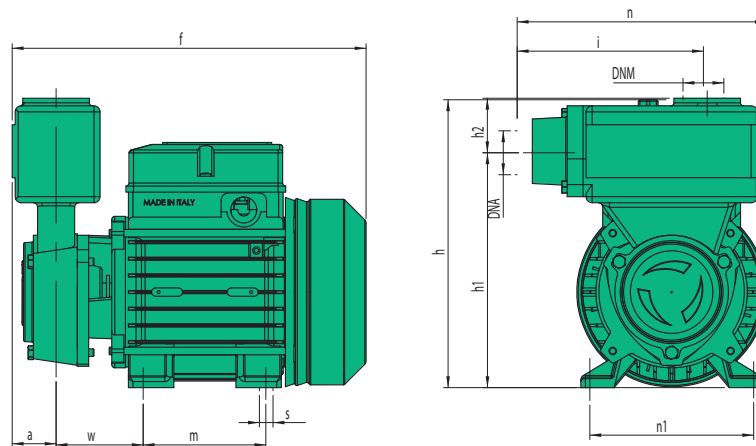

TIPO TYPE	DIMENSIONI [mm] DIMENSIONS [mm]												IMBALLO [mm] PACKING [mm]			PESO WEIGHT [kg]
	a	f	h	h1	h2	i	m	n	n1	w	DNA	DNM	A	L	P	
PLA 50	28	230	190	155	35	123	81	163	95	57	1"	1"	210	180	240	6,5

$\text{min}^{-1} \sim 2900$

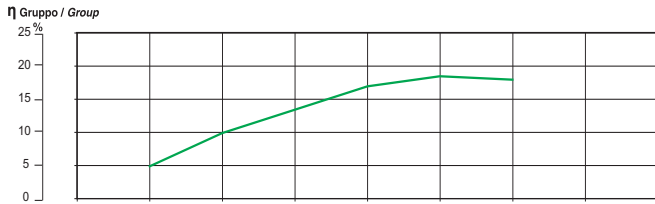
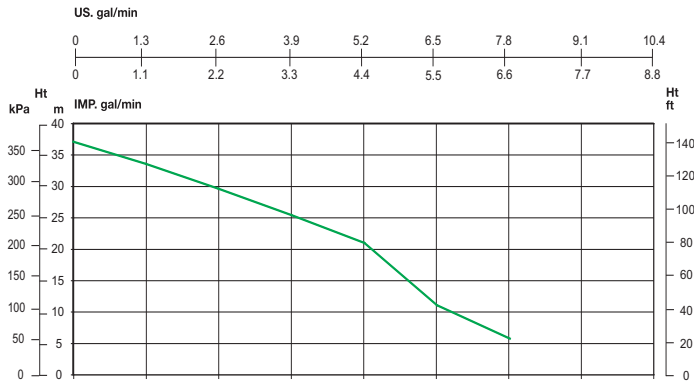

Portata - Capacity l/min: 0, 5, 10, 15, 20, 25, 30, 35, 40
 0, 0.3, 0.6, 0.9, 1.2, 1.5, 1.8, 2.1, 2.4
 Portata - Capacity m³/h

$\text{min}^{-1} \sim 3400$

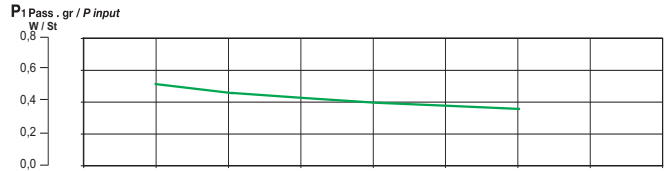
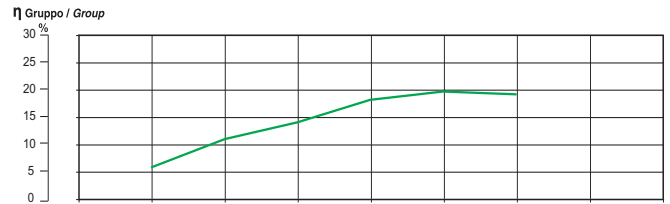
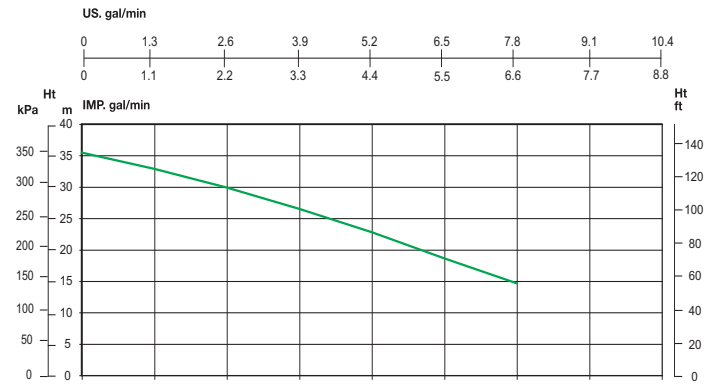

Portata - Capacity l/min: 0, 5, 10, 15, 20, 25, 30, 35, 40
 0, 0.3, 0.6, 0.9, 1.2, 1.5, 1.8, 2.1, 2.4
 Portata - Capacity m³/h

"Basic - Ondina"



Basic

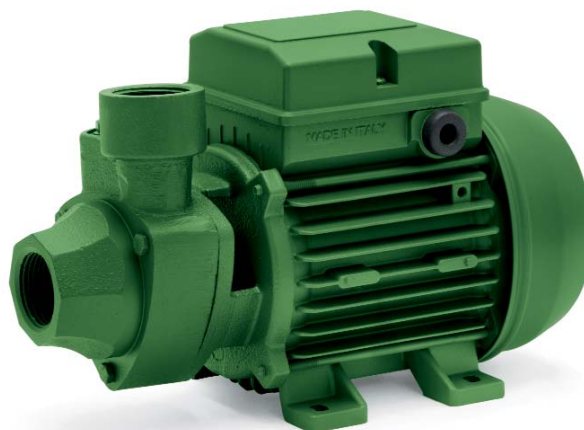

Ondina

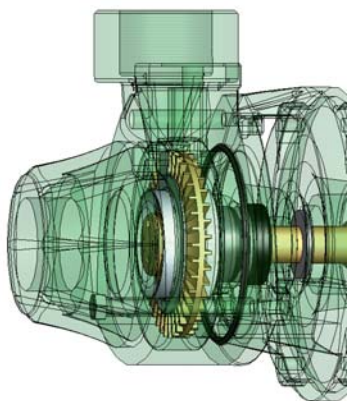

Ondina 50 ABS



NOMENCLATURA PARTI DI RICAMBIO
 SPARE PARTS LIST
 NOMENCLATURE PIECES DE RECHANGE
 NOMENCLATURA REPUESTOS

Sistema antibloccaggio "ABS" in acciaio inox Aisi 304 brevetto internazionale
 ABS" Anti-blocking system in Aisi 304 stainless steel international Patent
 Système antiblocage "ABS" en acier inox Aisi 304 brevet international
 Sistema antibloqueo "ABS" de acero inox Aisi 304 patente internacional

- 11 Albero con rotore – Pump shaft + rotor
Arbre + rotor – Eje rotor
- 14 Supporto mandata – Outlet bracket
Support envoyée – Soporte entrega
- 16 Girante – Impeller
Turbine – Impulsor
- 17 Tenuta meccanica – Mechanical seal
Garniture mécanique – Cierre mecánico
- 18 Corpo pompa – Pump body
Corp de pompe – Cuerpo bomba

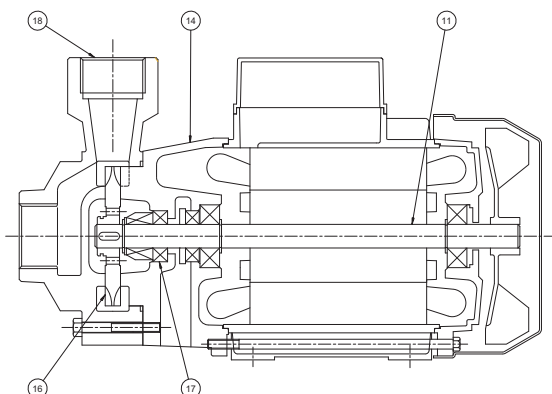

ELETTROPOMPE MONOBLOCCO PERIFERICHE

Le elettropompe monoblocco con girante periferica della serie BASIC & ONDINA sono state progettate per pompare liquidi puliti senza parti abrasive, senza corpi solidi in sospensione, non esplosivi o aggressivi per i materiali della pompa

- Temperatura max. del liquido fino a 35 °C per uso domestico (CEI EN 60335-2-41) o 90 °C per altri usi e temperatura ambiente fino a 40 °C.
- Portate fino a ~ 3 m³/h.
- Prevalenze fino a ~ 55 m

CARATTERISTICHE COSTRUTTIVE

- Corpo pompa: ghisa G20 con trattamento anticorrosione
- Supporto motore: ghisa G20 con trattamento anticorrosione
- Girante: ottone stampato UNI-EN 12165
- Albero pompa: acciaio inox Aisi 420F
- Tenuta meccanica: carbone-ceramica
- Sistema antibloccaggio "ABS" in acciaio inox Aisi 304 (solo ONDINA 50) brevetto internazionale N°IT1315401

MOTORE

I motori di comando sono del tipo asincrono a gabbia di scoiattolo chiusi, a ventilazione esterna

- Motoprotettore incorporato e condensatore permanentemente inserito per i tipi monofasi
- La protezione del motore nella versione trifase è a cura del cliente e si raccomandano apparecchiature in accordo con le norme vigenti
- Isolamento classe F (Classe B per Basic 50) –servizio S1- grado di protezione IP 44
- Protezione morsettiera IP 54

ÉLECTROPOMPES MONOBLOC PÉRIPHÉRIQUES

Les électropompes monobloc à roue périphérique de la série BASIC & ONDINA ont été conçues pour pomper des liquides propres sans parties abrasives, sans corps solides en suspension, non explosifs ou agressifs pour les matériaux de la pompe

- Température max. du liquide jusqu'à 35 °C pour utilisation domestique (CEI EN 60335-2-41) ou 90 °C pour d'autres utilisations et température ambiante jusqu'à 40 °C.
- Plage d'utilisation jusqu'à ~ 3 m³/h.
- Hauteur manométrique jusqu'à ~ 55 m.

CARACTERISTIQUES DE CONSTRUCTION

- Corps de pompe : En fonte G20 avec traitement anti-corrosion
- Lanterne: En fonte G20 avec traitement anti-corrosion
- Turbine: laiton étampé UNI-EN 12165
- Abris de pompe: acier inox Aisi 420F
- Garniture mécanique: Carbone dur - Céramique
- Système antiblocage "ABS" en acier AISI 304 (seulement ONDINA 50) International Patent No. IT1315401

MOTOR

Le moteurs sont asynchrones à cage d'écuriel fermés à ventilation extérieure monophasés,

- Pour les modèles monophasés son avec protection thermique et condensateur connecté en permanence
- Pour les modèles triphasés, la protection est à la charge de l'utilisateur. A recommandé l'équipement conformément à la réglementation
- A Classe d'isolation F - service S 1 – protection IP44
- Protection IP54 dans le terminal

CLOSE COUPLED PERIPHERAL PUMPS

The close-coupled pumps with peripheral impeller series BASIC & ONDINA have been designed to pump clean liquids, without abrasives and suspended solids, non-explosive or aggressive for the pump's materials

- Liquid temperature not higher than 35 °C for domestic use (CEI EN 60335-2-41) or 90 °C for other use, while the ambient temperature must not be higher than 40 °C
- Flow rate up to ~ 3 m³/h
- Heads up to ~ 55 m

TECHNICAL FEATURES

- Pump body: cast iron G20 with anti-corrosive coating
- Motor bracket: cast iron G20 with anti-corrosive coating
- Impeller: stamped brass UNI-EN 12165
- Pump shaft: stainless steel Aisi 420F
- Mechanical seal: carbon-ceramics
- "ABS" Anti-blocking system in Aisi 304 stainless steel (only ONDINA 50) international Patent N° IT1315401

MOTOR

The control motors are asynchronous, squirrel cage-type, closed, with external ventilation

- Incorporated motor protection and capacitor always on, for single-phase models
- The motor protection for three-phase models must be installed by the customer. Equipment compliant with current standards should be used
- Class of insulation: F (Class B per Basic 50)-service:S1-Degree of protection :IP 44
- Terminal board protection: IP 54

ELECTROBOMBAS MONOBLOQUE PERIFÉRICAS

Las electrobombas monobloque con impulsor periférico de la serie BASIC & ONDINA han sido proyectadas para bombear líquidos limpios sin partes abrasivas, sin cuerpos sólidos en suspensión, que no sean explosivos ni agresivos para los materiales de la bomba.

- Temperatura max. del líquido hasta 35 °C para uso doméstico (CEI EN 60335-2-41) o 90 °C para otros usos y temperatura ambiente hasta 40 °C.
- Caudal hasta ~ 3 m³/h.
- Alturas hasta ~ 55 m.

CARACTERÍSTICAS DE CONSTRUCCIÓN

- Cuerpo de bomba: Fundición gris G20 con tratamiento contra-corrosión
- Soporte: Fundición gris G20 con tratamiento contra-corrosión
- Rodete: De latón UNI-EN 12165
- Eje de la bomba: de acero Inox AISI420F
- Cierre mecánico: De cerámica y grafito
- Sistema de antibloqueo "ABS" de acero Inox AISI 304 (sòlo ONDINA 50) International Patent No. IT1315401

MOTOR

Los motores de accionamiento son asíncrono de jaula de ardilla cerrados, ventilados externamente

- Para los modelos monofásicos, protección térmica y condensador incorporado
- Para los modelos trifásicos de la protección se encarga el usuario, y el equipo recomendado de acuerdo con las normas
- Aislamiento de Clase F – funcionamiento S1- protección IP44
- Protección IP54 para el terminal

50 Hz - min⁻¹ ~ 2900

TIPO TYPE Monofase Single-phase	Potenza nominale Nominal power		Potenza assorbita Input power [W]	Condensatore Capacitor 450 V max [μF]	Corrente assorbita Input current [A]	Portata - Capacity										
	kW	HP				Q [m ³ /h]	0	0,3	0,6	1,2	1,8	2,4	3			
a			a		1~ 230 V	Prevalenza (m C.A.) Total head (m W.C.)										
BASIC 50 M	0,37	0,5	550	10	2,4	H [m]	35,0	33,0	29,0	20,0	11,0					
BASIC 80 M	0,6	0,8	1050	16	4,5		49,0	47,0	43,0	32,5	23,5	14,5	6			

a) ~ Monofase 230 V

b) ~ Trifase 230/400 V

TIPO TYPE Monofase Single-phase	TIPO TYPE Trifase Three-phase	Potenza nominale Nominal power		Potenza assorbita Input power [W]		Condensatore Capacitor 450 V max [μF]	Corrente assorbita Input current [A]			Portata - Capacity													
		kW	HP	a	b		1~230V	3~230V	3~400V	Q [m ³ /h]	0	0,3	0,6	0,9	1,2	1,5	1,8	2,1	2,4	2,7	3	3,3	
a	b			a	b		1~230V	3~230V	3~400V	Prevalenza (m C.A.) Total head (m W.C.)													
ONDINA 50 M	ONDINA 50 T	0,37	0,5	560	490	10	2,5	2,1	1	H [m]	37,0	33,4	29,4	25,2	20,7	15,8	10,7	5,3					
ONDINA 80 M	ONDINA 80 T	0,59	0,8	1150	1100	14	5,4	3,8	2,2		57,8	51,8	45,9	40,2	34,7	29,3	24,2	19,2	14,3	9,7	5,2		
ONDINA 100 M	ONDINA 100 T	0,74	1	1200	1230	25	5,7	4,1	2,4		66,4	58,8	51,5	44,6	38,1	31,8	25,9	20,3	15,1	10,2	5,6		

a) ~ Monofase 230 V

b) ~ Trifase 230/400 V

60 Hz - min⁻¹ ~ 3400

TIPO TYPE Monofase Single-phase	Potenza nominale Nominal power		Potenza assorbita Input power [W]	Condensatore Capacitor 450 V max [μF]	Corrente assorbita Input current [A]		Portata - Capacity							
	kW	HP			1~115V	1~220V	Q [m ³ /h]	0	0,3	0,6	1,2	1,8	2,4	3
a			a		1~115V	1~220V	Prevalenza (m C.A.) Total head (m W.C.)							
BASIC 50 M	0,37	0,5	700	16	6,6	2,9	H [m]	37,0	35,0	32,0	25,0	18,0	10	
BASIC 80 M	0,6	0,8	1080	16	-	4,2		56,0	54,0	50,0	42,0	33,0	23	15

a) ~ Monofase 115/220 V

b) ~ Trifase 220/380 V

TIPO TYPE Monofase Single-phase	TIPO TYPE Trifase Three-phase	Potenza nominale Nominal power		Potenza assorbita Input power [W]		Condensatore Capacitor 450 V max [μF]	Corrente assorbita Input current [A]				Portata - Capacity												
		kW	HP	a	b		1~115V	1~220V	3~220V	3~380V	Q [m ³ /h]	0	0,3	0,6	0,9	1,2	1,5	1,8	2,1	2,4	2,7	3	3,3
a	b			a	b		1~115V	1~220V	3~220V	3~380V	Prevalenza (m C.A.) Total head (m W.C.)												
ONDINA 50 M	ONDINA 50 T	0,37	0,5	722	260	12,5	6,7	3,2	1,6	0,6	H [m]	35,5	32,9	29,9	26,5	22,8	18,6	14,6	11,4				
ONDINA 80 M	-	0,59	0,8	1450	-	20	13,5	6,4	-	-		57,0	52,1	47,3	42,7	38,1	33,6	29,2	24,9	20,7	16,6	12,6	
ONDINA 100 M	ONDINA 100 T	0,74	1	2040	1180	20	18,6	8,7	4,8	2,7		80,6	74,2	67,8	61,7	55,6	49,8	44,1	38,5	33,1	27,8	22,7	

a) ~ Monofase 115/220 V

b) ~ Trifase 220/380 V

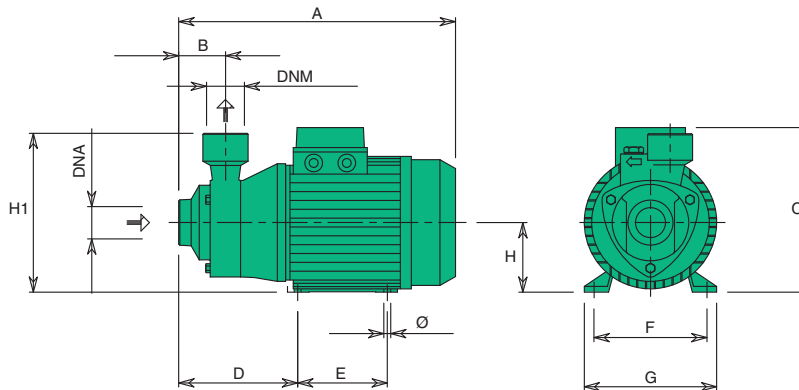

TIPO TYPE	DIMENSIONI [mm] DIMENSIONS [mm]										IMBALLO [mm] PACKING [mm]			PESO WEIGHT [kg]		
	A	B	C	D	E	F	G	Ø	H	H1	DNA	DNM	A		L	P
BASIC 50	262	45	154	115	80	100	120	7	63	148	1"	1"	180	150	280	5,8
BASIC 80	266	48	154	119	80	100	120	7	63	154	1"	1"	180	150	280	8,5
ONDINA 50	250	50	165	110	80	100	120	7	63	145	1"	1"	180	280	250	6,1
ONDINA 80	288	50	180	110	90	112	135	7	71	160	1"	1"	190	310	170	9,7
ONDINA 100	288	50	180	110	90	112	135	7	71	160	1"	1"	190	320	160	10,8

min⁻¹ ~ 2900

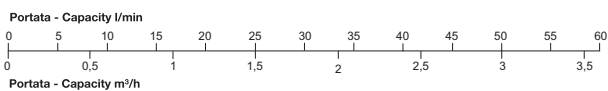
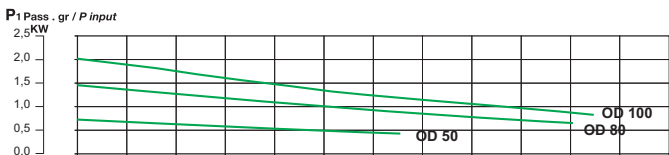
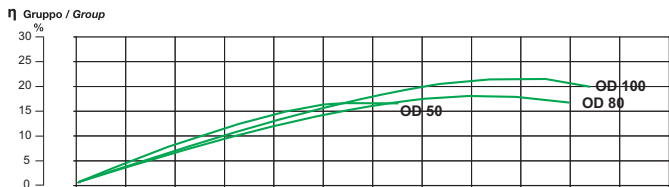
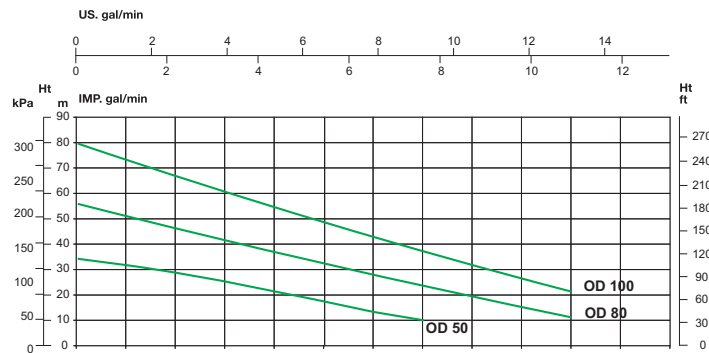
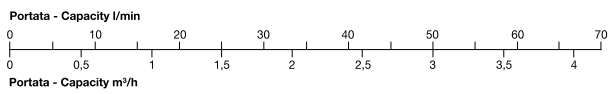
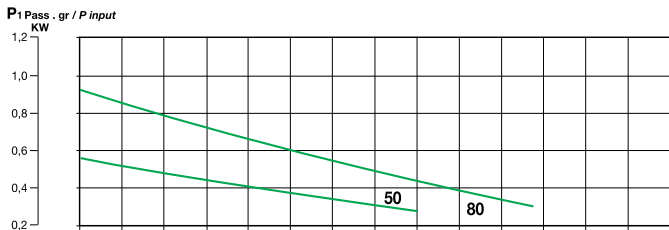
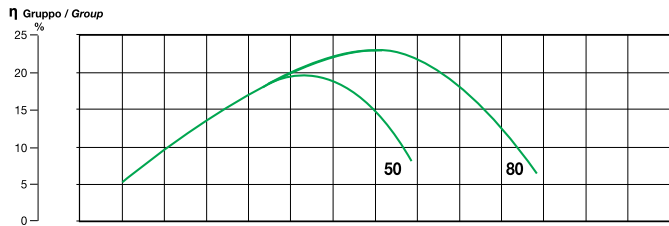
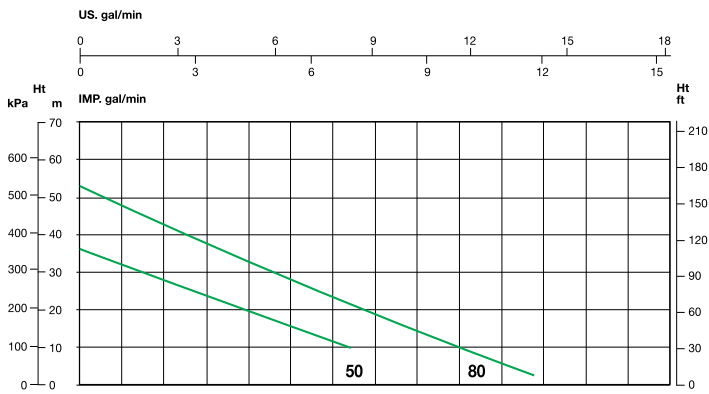

min⁻¹ ~ 3400

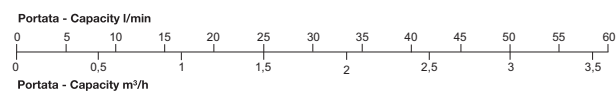
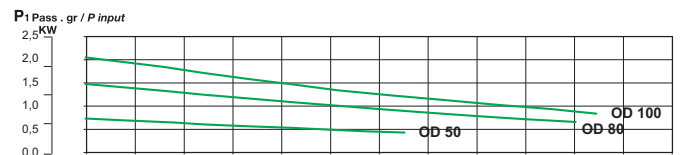
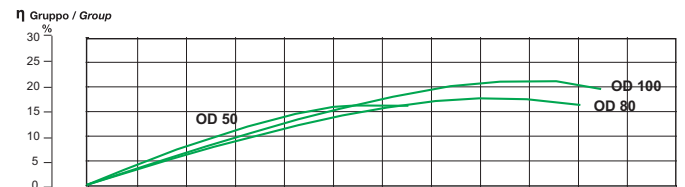
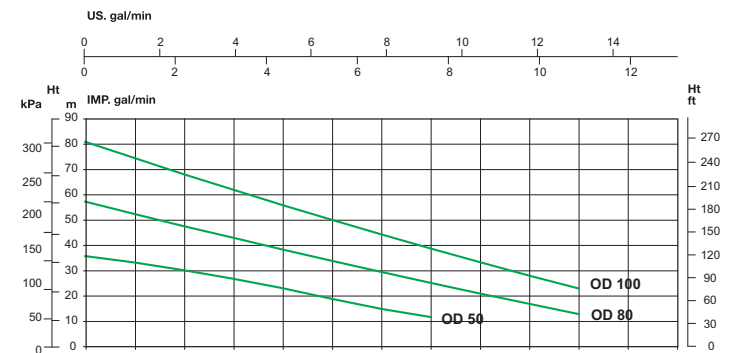
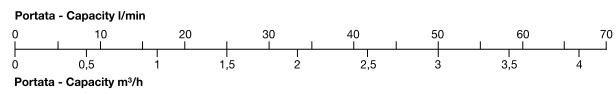
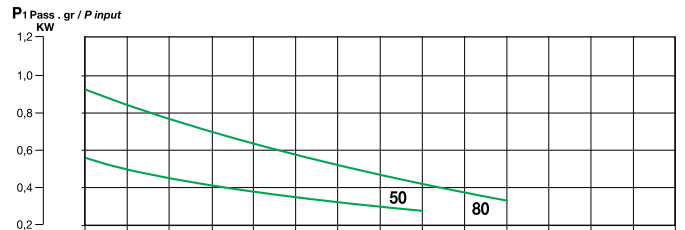
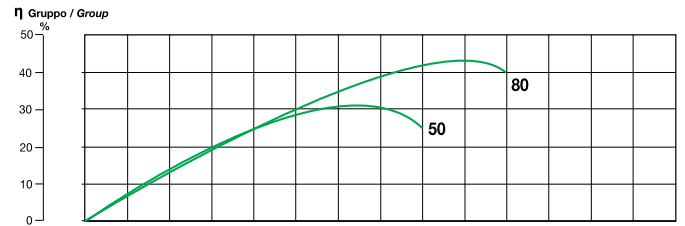
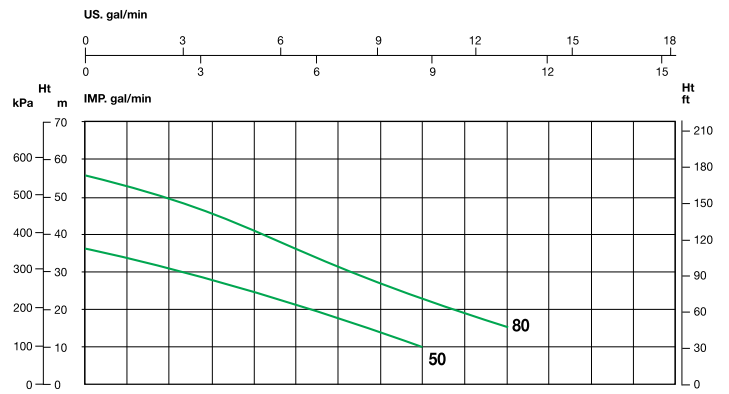

"PL"



NOMENCLATURA PARTI DI RICAMBIO
SPARE PARTS LIST
NOMENCLATURE PIECES DE RECHANGE
NOMENCLATURA REPUESTOS

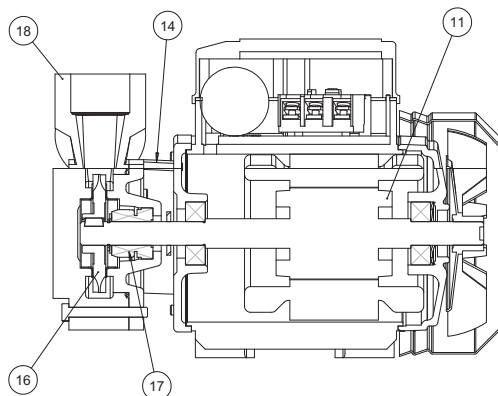

- 11** Albero con rotore – Pump shaft + rotor
Arbre + rotor – Eje rotor
- 14** Supporto mandata – Outlet bracket
Support envoyée – Soporte entrega
- 16** Girante – Impeller
Turbine – Impulsor
- 17** Tenuta meccanica – Mechanical seal
Garniture mécanique – Cierre mecánico
- 18** Corpo pompa – Pump body
Corp de pompe – Cuerpo bomba

ELETTROPOMPE MONOBLOCCO PERIFERICHE

Le elettropompe monoblocco con girante periferica della serie PL sono state progettate per pompare liquidi puliti senza parti abrasive, senza corpi solidi in sospensione, non esplosivi o aggressivi per i materiali della pompa

- Temperatura max. del liquido fino a 35 °C per uso domestico (CEI EN 60335-2-41) o 90 °C per altri usi e temperatura ambiente fino a 40 °C.
- Portate fino a ~ 2 m³/h.
- Prevalenze fino a ~ 55 m.

CARATTERISTICHE COSTRUTTIVE

- Corpo pompa: ghisa G20 con trattamento in cataforesi
- Supporto motore: ghisa G20 con trattamento in cataforesi
- Giranti: ottone stampato UNI-EN 12165
- Albero pompa: acciaio inox Aisi 420F
- Tenuta meccanica: carbone-ceramica
- Sistema antibloccaggio "ABS" in acciaio inox Aisi 304 brevetto internazionale N°IT1315401

MOTORE

I motori di comando sono del tipo asincrono a gabbia di scoiattolo chiusi, a ventilazione esterna

- Motoprotettore incorporato e condensatore permanentemente inserito per i tipi monofasi
- La protezione del motore nella versione trifase è a cura del cliente e si raccomandano apparecchiature in accordo con le norme vigenti
- Isolamento classe B –servizio S1- grado di protezione IP 44
- Protezione morsettiera IP 54

ÉLECTROPOMPES MONOBLOC PÉRIPHÉRIQUES

Les électropompes monobloc à roue périphérique de la série PL ont été conçues pour pomper des liquides propres sans parties abrasives, sans corps solides en suspension, non explosifs ou agressifs pour les matériaux de la pompe

- Température max. du liquide jusqu'à 35 °C pour utilisation domestique (CEI EN 60335-2-41) ou 90 °C pour d'autres utilisations et température ambiante jusqu'à 40 °C.
- Plage d'utilisation jusqu'à ~ 2 m³/h.
- Hauteur manométrique jusqu'à ~ 55 m.

CARACTERISTIQUES DE CONSTRUCTION

- Corps de pompe : En fonte G20 avec traitement en cataphorèse
- Lanterne: En fonte G20 avec traitement en cataphorèse
- Turbine: laiton étampé UNI-EN 12165
- Abre de pompe: acier inox Aisi 420F
- Garniture mécanique: Carbone dur - Céramique
- Système antiblocage "ABS" en acier AISI 304 International Patent No. IT1315401

MOTOR

Le moteurs sont asynchrones à cage d'écurieil fermés a à ventilation extérieure monofásicos,

- Pour le modèles monophasé son avec protection thermique et condensateur connecté en permanence
- Pour les modèles triphasés, la protection est à la charge de l'utilisateur. A recommandé l'équipement conformément à la réglementation
- A Classe d'isolation F - service S 1 – protection IP44
- Protection IP54 dans le terminal

CLOSE COUPLED PERIPHERAL PUMPS

The close-coupled pumps with peripheral impeller series PL have been designed to pump clean liquids, without abrasives and suspended solids, non-explosive or aggressive for the pump's materials

- Liquid temperature not higher than 35 °C for domestic use (CEI EN 60335-2-41) or 90 °C for other use, while the ambient temperature must not be higher than 40 °C
- Flow rate up to ~ 2 m³/h
- Heads up to ~ 55 m

TECHNICAL FEATURES

- Pump body: cast iron G20 with cataphoretic treatment
- Motor bracket: cast iron G20 with cataphoretic treatment
- Impeller: stamped brass UNI-EN 12165
- Pump shaft: stainless steel Aisi 420F
- Mechanical seal: carbon-ceramics
- "ABS" Anti-blocking system in Aisi 304 stainless steel international Patent N° IT1315401

MOTOR

The control motors are asynchronous, squirrel cage-type, closed, with external ventilation

- Incorporated motor protection and capacitor always on, for single-phase models
- The motor protection for three-phase models must be installed by the customer. Equipment compliant with current standards should be used
- Class of insulation: B -service:S1-Degree of protection: IP 44
- Terminal board protection: IP 54

ELECTROBOMBAS MONOBLOQUE PERIFÉRICAS

Las electrobombas monobloque con impulsor periférico de la serie PL han sido proyectadas para bombear líquidos limpios sin partes abrasivas, sin cuerpos sólidos en suspensión, que no sean explosivos ni agresivos para los materiales de la bomba.

- Temperatura max. del líquido hasta 35 °C para uso doméstico (CEI EN 60335-2-41) o 90 °C para otros usos y temperatura ambiente hasta 40 °C.
- Caudal hasta ~ 2 m³/h.
- Alturas hasta ~ 55 m.

CARACTERÍSTICAS DE CONSTRUCCIÓN

- Cuerpo de bomba: Fundición gris G20 con tratamiento en cataforesis
- Soporte: Fundición gris G20 con tratamiento en cataforesis
- Rodete: De latón UNI-EN 12165
- Eje de la bomba: de acero Inox AISI420F
- Cierre mecánico: De cerámica y grafito
- Sistema de antibloqueo "ABS" de acero Inox AISI 304 International Patent No. IT1315401

MOTOR

Los motores de accionamiento son asíncrono de jaula de ardilla cerrados, ventilados externamente

- Para los modelos monofásicos, protección térmica y condensador incorporado
- Para los modelos trifásicos de la protección se encarga el usuario y el equipo recomendado de acuerdo con las normas
- Aislamiento de Clase F – funcionamiento S1- protección IP44
- Protección IP54 para el terminal

50 Hz - min⁻¹ ~ 2900

TIPO TYPE		Potenza nominale Nominal power		Potenza assorbita Input power [W]		Condensatore Capacitor 450 V max	Corrente assorbita Input current [A]			Portata - Capacity							
Monofase Single-phase	Trifase Three-phase	kW	HP	a	b	[μF]	1~230V	3~230V	3~400V	Q [m ³ /h]	0	0,3	0,6	0,9	1,2	1,5	1,8
a	b									Q [l/s]	0	5	10	15	20	25	30
										Prevalenza (m C.A.) Total head (m W.C.)							
PL 50 M	PL 50 T	0,37	0,5	560	490	10	2,4	2,1	1	H [m]	37,0	33,4	29,4	25,2	20,7	10,7	5,3

a) ~ Monofase 230 V

b) ~ Trifase 230/400 V

60 Hz - min⁻¹ ~ 3400

TIPO TYPE		Potenza nominale Nominal power		Potenza assorbita Input power [W]		Condensatore Capacitor 450 V max	Corrente assorbita Input current [A]				Portata - Capacity							
Monofase Single-phase	Trifase Three-phase	kW	HP	a	b	[μF]	1~115 V	1~220 V	3~220 V	3~380 V	Q [m ³ /h]	0	0,3	0,6	0,9	1,2	1,5	1,8
a	b										Q [l/s]	0	5	10	15	20	25	30
										Prevalenza (m C.A.) Total head (m W.C.)								
PL 50 M	PL 50 T	0,37	0,5	722	460	12,5	6,7	3,2	1,8	0,9	H [m]	35,5	32,9	29,9	26,5	22,8	18,6	14,6

a) ~ Monofase 115/220 V

b) ~ Trifase 220/380 V

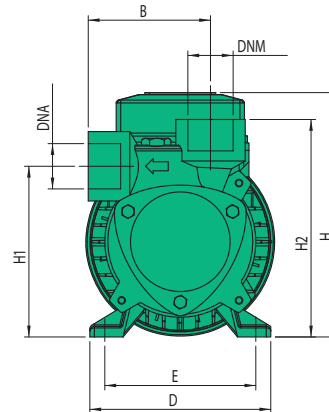
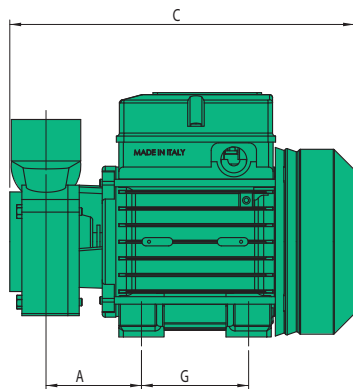

TIPO TYPE	DIMENSIONI [mm] DIMENSIONS [mm]											IMBALLO [mm] PACKING [mm]			PESO WEIGHT [kg]
	A	B	C	D	E	G	H	H1	H2	DNA	DNM	A	L	P	
PL 50	60	80	230	120	100	80	165	117	149	1"	1"	180	280	250	6,5

$\text{min}^{-1} \sim 2900$

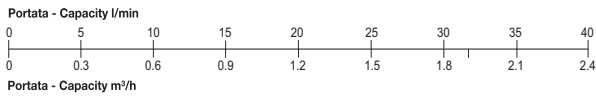
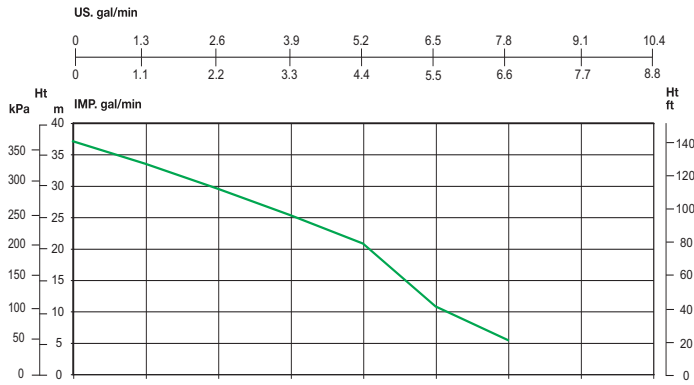

$\text{min}^{-1} \sim 3400$

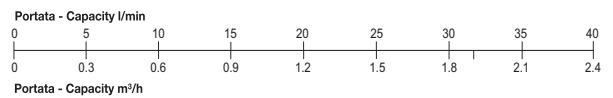
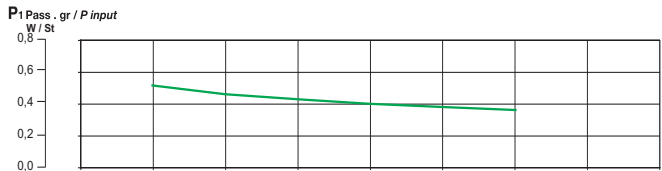
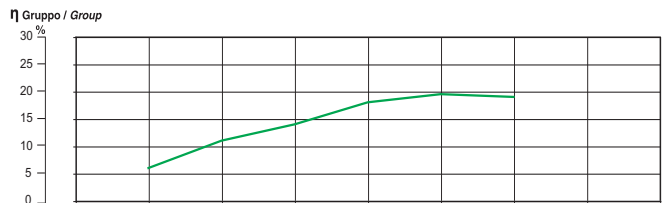
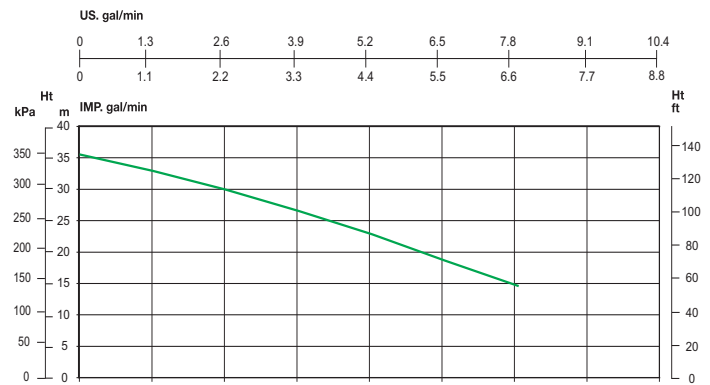

"K"



NOMENCLATURA PARTI DI RICAMBIO
SPARE PARTS LIST
NOMENCLATURE PIECES DE RECHANGE
NOMENCLATURA REPUESTOS

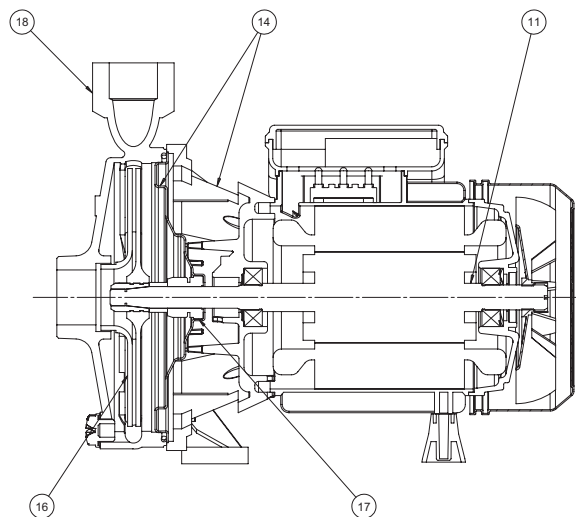

- 11 Albero con rotore – Pump shaft + rotor
Arbre + rotor – Eje rotor
- 14 Supporto mandata – Outlet bracket
Support envoyée – Soporte entrega
- 16 Girante – Impeller
Turbine – Impulsor
- 17 Tenuta meccanica – Mechanical seal
Garniture mécanique – Cierre mecánico
- 18 Corpo pompa – Pump body
Corp de pompe – Cuerpo bomba

ELETTROPOMPE CENTRIFUGHE MONOGIRANTE

Le elettropompe centrifughe monogiranti della serie K, sono state progettate per pompare liquidi, senza parti abrasive, senza corpi solidi in sospensione, non esplosivi o aggressivi per i materiali della pompa

- Temperatura max. del liquido fino a 35 °C per uso domestico (CEI EN 60335-2-41) o 90 °C per altri usi e temperatura ambiente fino a 40 °C.
- Portate fino a 18 m³/h.
- Prevalenze fino a ~ 60 m.

CARATTERISTICHE COSTRUTTIVE

- Corpo pompa: ghisa G20 con trattamento anticorrosione
- Supporto motore: alluminio pressofuso UNI 5076 (ghisa per K 50, 150-550)
- Girante: Tecnopolimero (ottone stampato UNI- EN 12165 per K 150-550)
- Albero pompa: acciaio inox Aisi 304 (Aisi 420 F per K 50-100)
- Tenuta meccanica: carbone-ceramica

MOTORE

I motori di comando sono del tipo asincrono a gabbia di scoiattolo chiusi, a ventilazione esterna

- Motoprotettore incorporato e condensatore permanentemente inserito per i tipi monofasi
- La protezione del motore nella versione trifase è a cura del cliente e si raccomandano apparecchiature in accordo con le norme vigenti
- Isolamento classe F – servizio S1- grado di protezione IP 44
- Protezione morsettiera IP 54

ÉLECTROPOMPES CENTRIFUGES À UNE ROUE

Les électropompes centrifuges à une roue de la série K, ont été conçues pour pomper des liquides, sans parties abrasives, sans corps liquides en suspension, non explosifs ou agressifs pour les matériaux de la pompe

- Température max. du liquide jusqu'à 35 °C pour utilisation domestique (CEI EN 60335-2-41) ou 90 °C pour d'autres utilisations et température ambiante jusqu'à 40 °C.
- Plage d'utilisation jusqu'à 18 m³/h.
- Hauteur manométrique jusqu'à ~ 60 m.

CARACTERISTIQUES DE CONSTRUCTION

- Corps de pompe : En fonte G20 avec traitement anti-corrosion
- Lanterne: aluminium moulé sur pression UNI 5076 (en fonte pour K 50, 150÷550)
- Turbine: Technopolymère (laiton estampé UNI- EN 12165 pour K 150-550)
- Abris de pompe: acier inox Aisi 304 (Aisi 420 F pour K 50-100)
- Garniture mécanique: Carbone dur - Céramique

MOTOR

Le moteurs sont asynchrones à cage d'écuriel fermés à ventilation extérieure monophasés,

- Pour le modèles monophasés son avec protection thermique et condensateur connecté en permanence
- Pour les modèles triphasés, la protection est à la charge de l'utilisateur. A recommandé l'équipement conformément à la réglementation
- A Classe d'isolation F - service S 1 – protection IP44
- Protection IP54 dans le terminal

CENTRIFUGAL ELECTRIC PUMPS ONE IMPELLER

The close-coupled centrifugal electric pumps with one impeller series K have been designed to pump clear liquids, without abrasives and suspended solids, non-explosive or aggressive for the pump's materials

- Liquid temperature not higher than 35 °C for domestic use (CEI EN 60335-2-41) or 90 °C for other use, while the ambient temperature must not be higher than 40 °C
- Flow rate up to ~ 18 m³/h
- Heads up to ~ 60

TECHNICAL FEATURES

- Pump body: cast iron G20 with anti-corrosive coating
- Motor bracket: in die casting aluminium UNI 5076 (cast iron for K 50, 150-550)
- Impeller: Techno-polymer (stamped brass UNI- EN 12165 for K 150-550)
- Pump shaft: stainless steel Aisi 304 (Aisi 420 F for K 50-100)
- Mechanical seal: carbon-ceramics

MOTOR

The control motors are asynchronous, squirrel cage-type, closed, with external ventilation

- Incorporated motor protection and capacitor always on, for single-phase models
- The motor protection for three-phase models must be installed by the customer. Equipment compliant with current standards should be used
- Class of insulation:F-service:S1-Degree of protection: IP 44
- Terminal board protection: IP 54

ELECTROBOMBAS CENTRÍFUGAS MONOIMPULSOR

Las electrobombas centrifugas con monoimpulsor de la serie K, han sido proyectadas para bombear líquidos, sin partes abrasivas, sin cuerpos sólidos en suspensión, que no sean explosivos ni agresivos para los materiales de la bomba.

- Temperatura max. del líquido hasta 35 °C para uso doméstico (CEI EN 60335-2-41) o 90 °C para otros usos y temperatura ambiente hasta 40 °C.
- Caudal hasta 18 m³/h.
- Alturas hasta ~ 60 m.

CARACTERÍSTICAS DE CONSTRUCCIÓN

- Cuerpo de bomba: Fundición gris G20 con tratamiento contra-corrosión
- Soporte: fundición de aluminio UNI 5076 (Fundición gris para las K 50, 150÷550)
- Rodete: De tecnopolímero (De latón UNI- EN 12165 para las 150÷550)
- Eje de la bomba: de acero Inox AISI 304 (Aisi 420 F para las K 50÷100)
- Cierre mecánico: De cerámica y grafito

MOTOR

Los motores de accionamiento son asíncrono de jaula de ardilla cerrados, ventilados externamente

- Para los modelos monofásicos, protección térmica y condensador incorporado
- Para los modelos trifásicos de la protección se encarga el usuario y el equipo recomendado de acuerdo con las normas
- Aislamiento de Clase F – funcionamiento S1- protección IP44
- Protección IP54 para el terminal

50 Hz - min⁻¹ ~ 2900

TIPO TYPE		Potenza nominale Nominal power		Potenza assorbita Input power [W]		Condensatore Capacitor 450 V max	Corrente assorbita Input current [A]			Portata - Capacity								
Monofase Single-phase	Trifase Three-phase	kW	HP	a	b	[μF]	1~230V	3~230V	3~400V	Q [m ³ /h]	0	1,2	2,4	3,6	4,8	6	7,8	
a	b									Q [l/1']	0	20	40	60	80	100	130	
K 50 M	K 50 T	0,37	0,5	680	710	12,5	2,6	1,9	1,1	Prevalenza (m C.A.) Total head (m W.C.)								
K 80 M	K 80 T	0,6	0,8	1170	1040	16	4,8	3,2	1,8	H [m]	20,0	19,5	18,0	16,0	12,5	8,5		
K 100 M	K 100 T	0,75	1	1450	1490	25	5,8	4	2,3	H [m]	30,0	29,0	28,0	25,5	22,5	18		
										H [m]	33,0	32,0	30,5	28,0	25,0	20,5	12,5	

a) ~ Monofase 230 V

b) ~ Trifase 230/400 V

TIPO TYPE		Potenza nominale Nominal power		Potenza assorbita Input power [W]		Condensatore Capacitor 450 V max	Corrente assorbita Input current [A]			Portata - Capacity								
Monofase Single-phase	Trifase Three-phase	kW	HP	a	b	[μF]	1~230V	3~230V	3~400V	Q [m ³ /h]	0	2,4	4,8	7,2	9	10,2	10,8	
a	b									Q [l/1']	0	40	80	120	150	170	180	
K 151 M	K 151 T	1,1	1,5	1980	1990	31,5	9	6	3,5	Prevalenza (m C.A.) Total head (m W.C.)								
K 200 M	K 200 T	1,47	2	2730	2630	45	12	8,3	4,8	H [m]	41,0	40,0	36,8	30,0	20,0			
K 300 M	K 300 T	2,2	3	3100	2970	55	13,6	8,9	5,1	H [m]	47,4	45,9	41,3	33,7	24,2	16,1	10	
										H [m]	52,9	51,5	47,2	40,1	32,8	24	19,5	

a) ~ Monofase 230 V

b) ~ Trifase 230/400 V

TIPO TYPE		Potenza nominale Nominal power		Potenza assorbita Input power [W]		Condensatore Capacitor 450 V max	Corrente assorbita Input current [A]			Portata - Capacity								
Monofase Single-phase	Trifase Three-phase	kW	HP	a	b	[μF]	1~230V	3~230V	3~400V	Q [m ³ /h]	0	3	6	9	12	15	18	
a	b									Q [l/1']	0	50	100	150	200	250	300	
K 400 M	K 400 T	3	4	4180	4470	70	18	13,5	7,8	Prevalenza (m C.A.) Total head (m W.C.)								
-	K 550 T	4	5,5	-	5860	-	-	19	10,2	H [m]	48,5	48,0	48,0	46,0	42,0	38	32	
										H [m]	61,0	61,0	60,0	59,0	57,0	54	49,5	

a) ~ Monofase 230 V

b) ~ Trifase 230/400 V

60 Hz - min⁻¹ ~ 3400

TIPO TYPE		Potenza nominale Nominal power		Potenza assorbita Input power [W]		Condensatore Capacitor 450 V max	Corrente assorbita Input current [A]				Portata - Capacity							
Monofase Single-phase	Trifase Three-phase	kW	HP	a	b	[μF]	1~115V	1~220V	3~220V	3~380V	Q [m ³ /h]	0	1,2	2,4	3,6	4,8	6	7,8
a	b										Q [l/1']	0	20	40	60	80	100	130
K 50 M	K 50 T	0,37	0,5	720	760	16	6,6	2,2	2,1	1,3	Prevalenza (m C.A.) Total head (m W.C.)							
K 80 M	K 80 T	0,6	0,8	1160	1190	20	9,5	3,2	3,3	1,8	H [m]	21,5	20,6	19,0	16,9	13,6	10,3	
K 100 M	K 100 T	0,75	1	1230	1520	20	13	4	4	2,3	H [m]	31,5	30,0	28,0	26,0	24,0	19,0	
											H [m]	33,5	32,5	31,0	29,0	27,0	24	16

a) ~ Monofase 115/220 V

b) ~ Trifase 220/380 V

TIPO TYPE		Potenza nominale Nominal power		Potenza assorbita Input power [W]		Condensatore Capacitor 450 V max	Corrente assorbita Input current [A]			Portata - Capacity								
Monofase Single-phase	Trifase Three-phase	kW	HP	a	b	[μF]	1~220V	3~220V	3~380V	Q [m ³ /h]	0	2,4	4,8	7,2	9	10,2	10,8	
a	b									Q [l/1']	0	40	80	120	150	170	180	
K 151 M	K 151 T	1,1	1,5	1990	2120	31,5	6	6,9	3,5	Prevalenza (m C.A.) Total head (m W.C.)								
K 201 M	K 201 T	1,47	2	2500	2630	45	11,5	7,3	4,2	H [m]	47,6	47,0	44,3	33,8	23,6	10,0		
-	K 300 T	2,2	3	-	3120	-	-	9,8	5,3	H [m]	51,6	50,0	46,8	41,4	34,8	24,1	16,4	

a) ~ Monofase 220 V

b) ~ Trifase 220/380 V

TIPO TYPE		Potenza nominale Nominal power		Potenza assorbita Input power [W]		Corrente assorbita Input current [A]			Portata - Capacity							
	Trifase Three-phase	kW	HP	b	b	3~220V	3~380V		Q [m ³ /h]	0	3	6	9	12	15	18
									Q [l/1']	0	50	100	150	200	250	300
	K 400 T	3	4	4530		14	6,8		H [m]	49,5	48,0	47,0	44,5	42,0	38,7	34
	K 550 T	4	5,5	5700		17	8		H [m]	57,0	56,0	54,0	51,5	49,0	45	41

b) ~ Trifase 220/380 V

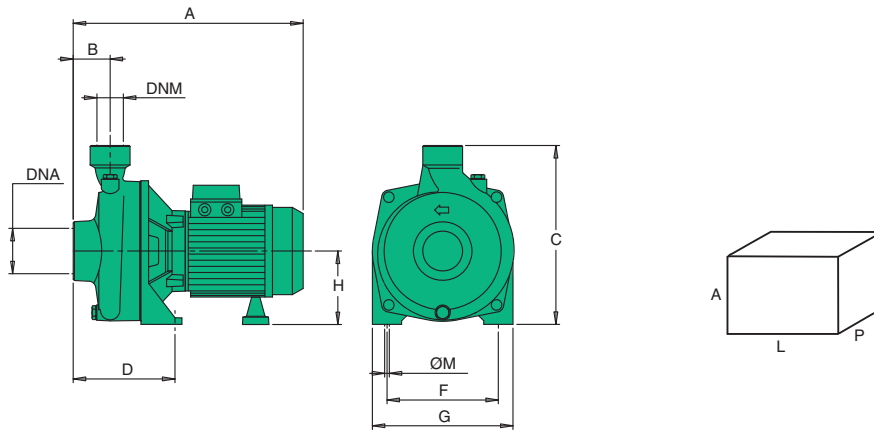

TIPO TYPE	DIMENSIONI [mm] DIMENSIONS [mm]										IMBALLO [mm] PACKING [mm]			PESO WEIGHT [kg]
	A	B	C	D	F	G	Ø	H	DNA	DNM	A	L	P	
K 50	265	45	206	103	124	164	9	85	1"	1"	170	300	250	9,2
K 80	283	45	237	105	140	180	9	97	1"	1"	280	330	200	11,2
K 100	283	45	237	105	140	180	9	97	1"	1"	280	330	200	12,4
K 151	344	47	262	107	149	199	11	110	1" 1/4	1"	320	350	220	20,8
K 201	344	47	262	107	149	199	11	110	1" 1/4	1"	320	350	220	22,8
K 200	373	52	294	30	160	223	11	118	1" 1/4	1"	350	450	260	25,2
K 300	373	52	294	30	160	223	11	118	1" 1/4	1"	350	450	260	26,6
K 400	442	57	340	93	200	250	14	150	1" 1/2	1" 1/4	380	290	520	44,5
K 550	442	57	340	93	200	250	14	150	1" 1/2	1" 1/4	380	290	520	46,5

min⁻¹ ~ 2900

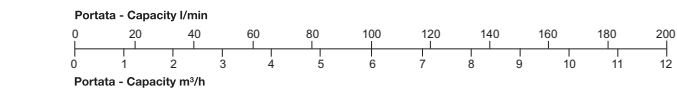
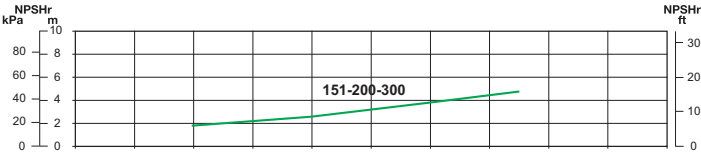
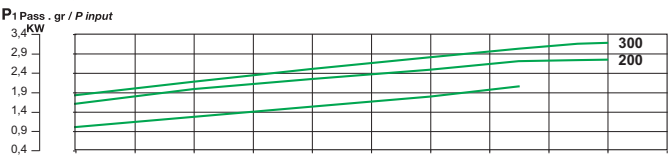
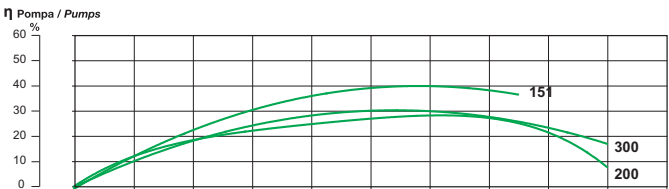
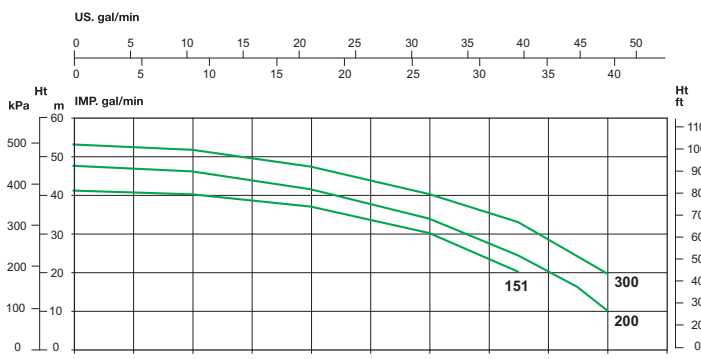
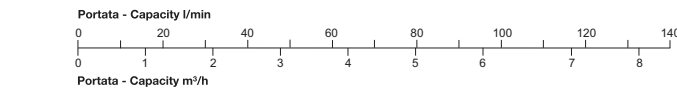
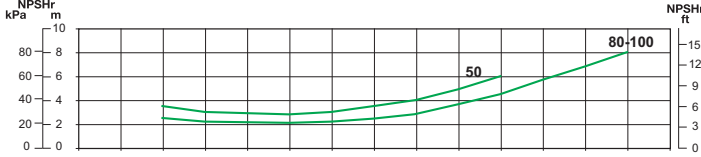
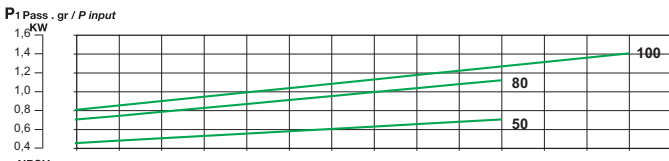
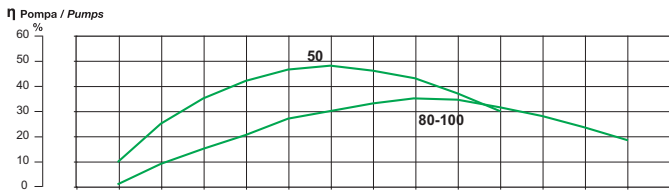
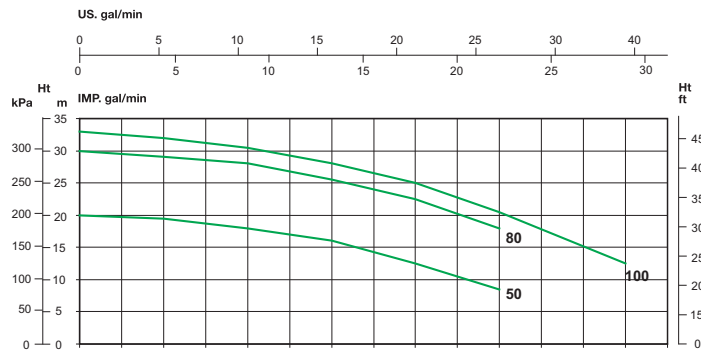

min⁻¹ ~ 3400

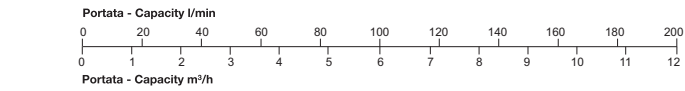
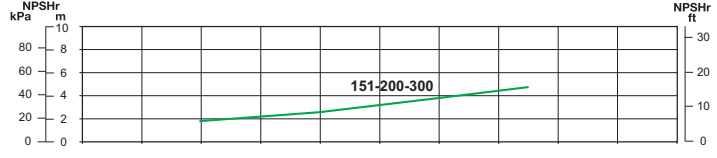
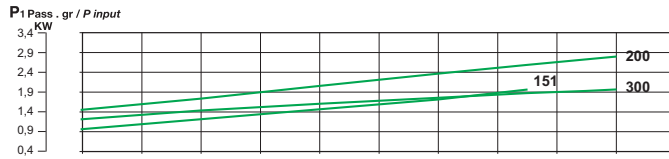
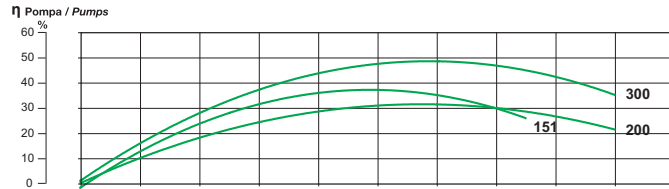
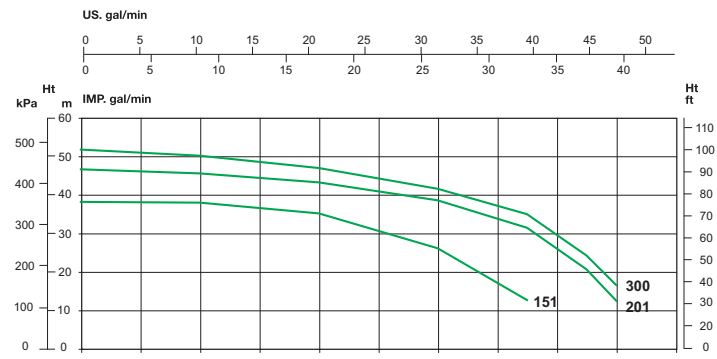
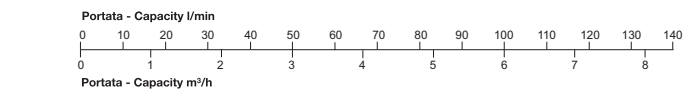
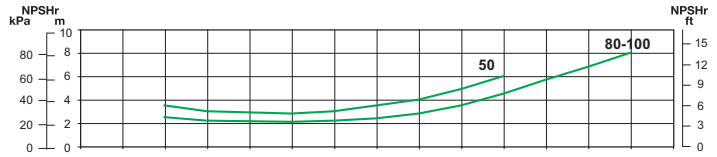
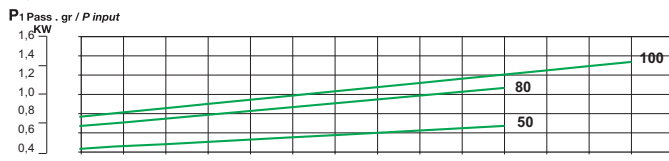
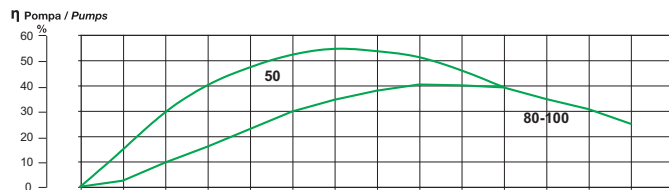
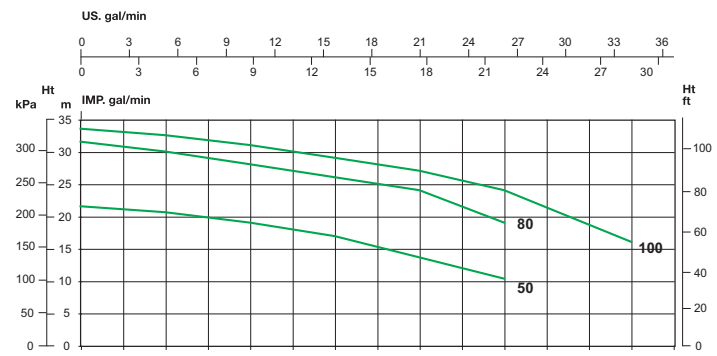

min⁻¹ ~ 2900

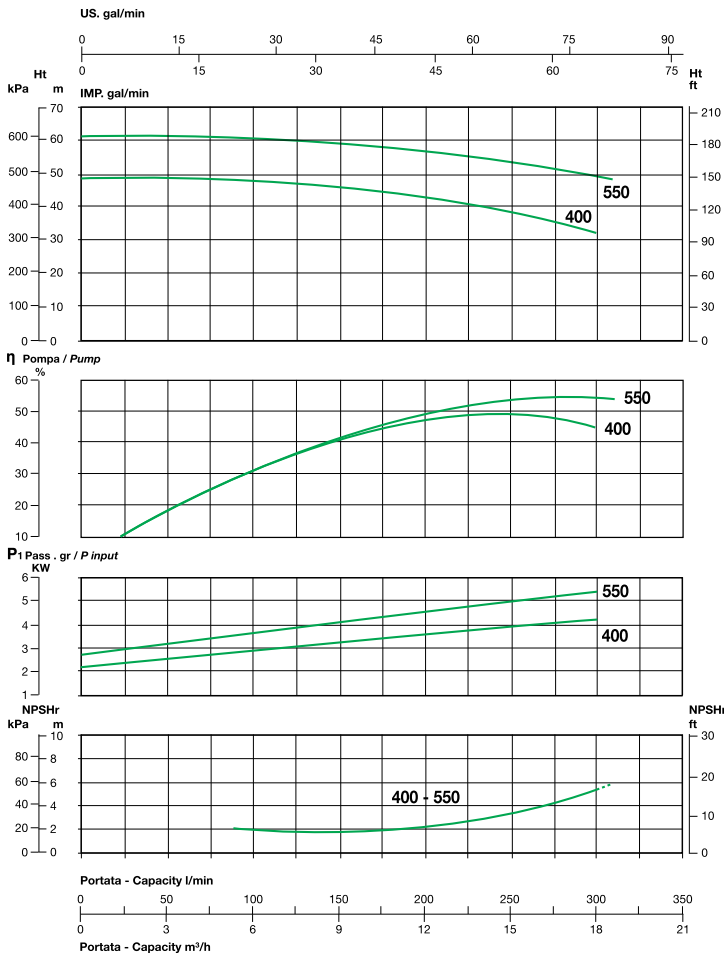

min⁻¹ ~ 3400

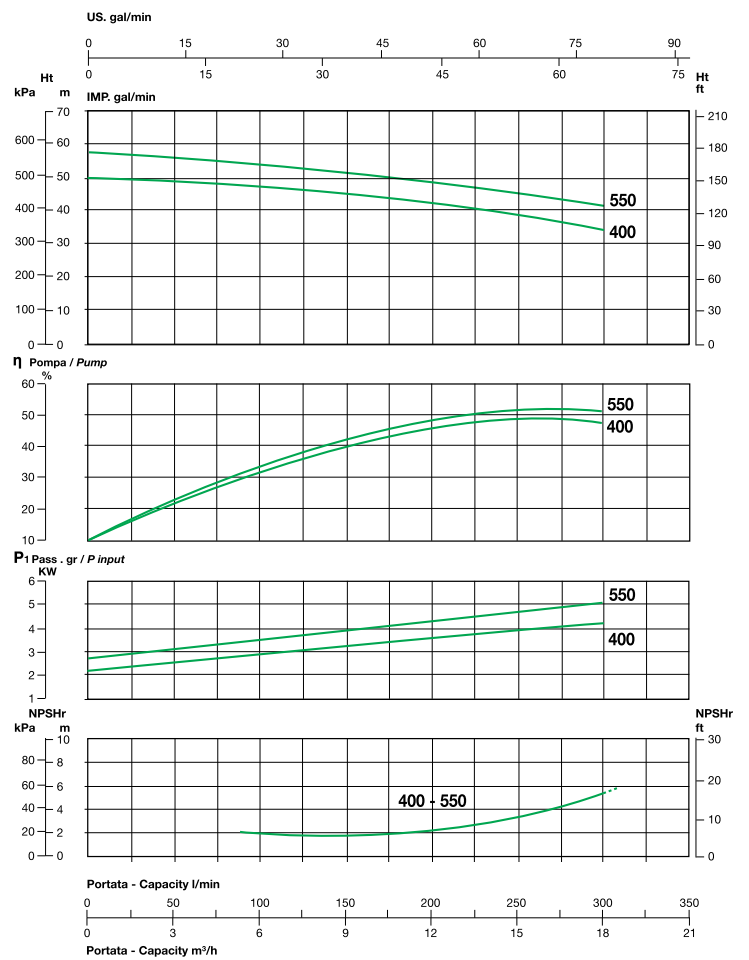

"KA"



NOMENCLATURA PARTI DI RICAMBIO
SPARE PARTS LIST
NOMENCLATURE PIECES DE RECHANGE
NOMENCLATURA REPUESTOS

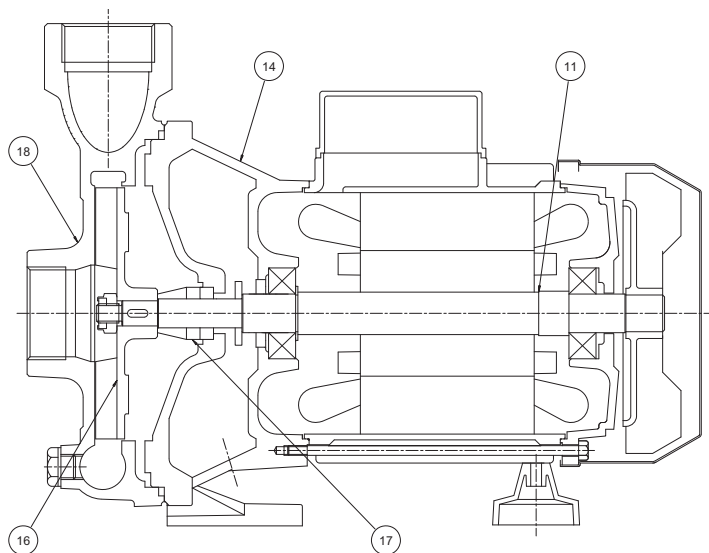

- 11** Albero con rotore – Pump shaft + rotor
Arbre + rotor – Eje rotor
- 14** Supporto mandata – Outlet bracket
Support envoyée – Soporte entrega
- 16** Girante – Impeller
Turbine – Impulsor
- 17** Tenuta meccanica – Mechanical seal
Garniture mécanique – Cierre mecánico
- 18** Corpo pompa – Pump body
Corp de pompe – Cuerpo bomba

ELETTROPOMPE CENTRIFUGHE A GIRANTE APERTA 1"1/2

Le elettropompe centrifughe monogiranti della serie KA sono state progettate per pompare liquidi puliti senza parti abrasive, senza corpi solidi in sospensione, non esplosivi o aggressivi per i materiali della pompa

- Temperatura max. del liquido fino a 35 °C per uso domestico (CEI EN 60335-2-41) o 90 °C per altri usi e temperatura ambiente fino a 40 °C.
- Portate fino a 30 m³/h.
- Prevalenze fino a ~ 22 m.

CARATTERISTICHE COSTRUTTIVE

- Corpo pompa: ghisa G20 con trattamento anticorrosione
- Supporto motore: ghisa G20 con trattamento anticorrosione
- Girante: ghisa G20 con trattamento anticorrosione (Tecnopolimero per KA 80-100)
- Albero pompa: acciaio inox Aisi 304 (Aisi 420 F per KA 80-100)
- Tenuta meccanica: carbone-ceramica

MOTORE

I motori di comando sono del tipo asincrono a gabbia di scoiattolo chiusi, a ventilazione esterna

- Motoprotettore incorporato e condensatore permanentemente inserito per i tipi monofasi
- La protezione del motore nella versione trifase è a cura del cliente e si raccomandano apparecchiature in accordo con le norme vigenti
- Isolamento classe F –servizio S1- grado di protezione IP 44
- Protezione morsettiera IP 54

ÉLETTROPOMPES CENTRIFUGES À ROUE OUVERTE 1"1/2

Les électropompes centrifuges à une roue de la série KA ont été conçues pour pomper des liquides propres sans parties abrasives, sans corps liquides en suspension, non explosifs ou agressifs pour les matériaux de la pompe

- Température max. du liquide jusqu'à 35 °C pour utilisation domestique (CEI EN 60335-2-41) ou 90 °C pour d'autres utilisations et température ambiante jusqu'à 40 °C.
- Plage d'utilisation jusqu'à 30 m³/h.
- Hauteur manométrique jusqu'à ~ 22 m.

CARACTERISTIQUES DE CONSTRUCTION

- Corps de pompe : En fonte G20 avec traitement anti-corrosion
- Lanterne: En fonte G20 avec traitement anti-corrosion
- Turbine: En fonte G20 avec traitement anti-corrosion (Technopolymère pour KA 80-100)
- Abre de pompe: acier inox Aisi 304 (Aisi 420 F pour KA 80-100)
- Garniture mécanique: Carbone dur – Céramique

MOTOR

Le moteurs sont asynchrones à cage d'écuriel fermés à ventilation extérieure monofásicos,

- Pour les modèles monophasés son avec protection thermique et condensateur connecté en permanence
- Pour les modèles triphasés, la protection est à la charge de l'utilisateur. A recommandé l'équipement conformément à la réglementation
- A Classe d'isolation F - service S 1 – protection IP44
- Protection IP54 dans le terminal

CENTRIFUGAL ELECTRIC PUMPS WITH OPEN IMPELLER 1"1/2

The close-coupled centrifugal electric pumps with one impeller series KA have been designed to pump clear liquids, without abrasives and suspended solids, non-explosive or aggressive for the pump's materials

- Liquid temperature not higher than 35 °C for domestic use (CEI EN 60335-2-41) or 90 °C for other use, while the ambient temperature must not be higher than 40 °C
- Flow rate up to ~ 30 m³/h
- Heads up to ~ 22 m

TECHNICAL FEATURES

- Pump body: cast iron G20 with anti-corrosive coating
- Motor bracket: cast iron G20 with anti-corrosive coating
- Impeller: cast iron G20 with anti-corrosive coating (Technopolymer for KA 80-100)
- Pump shaft: stainless steel Aisi 304 (Aisi 420 F for KA 80-100)
- Mechanical seal: carbon-ceramics

MOTOR

The control motors are asynchronous, squirrel cage-type, closed, with external ventilation

- Incorporated motor protection and capacitor always on, for single-phase models
- The motor protection for three-phase models must be installed by the customer. Equipment compliant with current standards should be used
- Class of insulation:F-service:S1-Degree of protection: IP 44
- Terminal board protection: IP 54

ELECTROBOMBAS CENTRÍFUGAS A IMPULSOR ABIERTO 1"1/2

Las electrobombas centrifugas con monoimpulsor della serie KA han sido proyectadas para bombear líquidos limpios sin partes abrasivas, sin cuerpos sólidos en suspensión, que no sean explosivos ni agresivos para los materiales de la bomba.

- Temperatura max. del líquido hasta 35 °C para uso doméstico (CEI EN 60335-2-41) o 90 °C para otros usos y temperatura ambiente hasta 40 °C.
- Caudal hasta 30 m³/h.
- Alturas hasta ~ 22 m.

CARACTERISTICAS DE CONSTRUCCIÓN

- Cuerpo de bomba: Fundición gris G20 con tratamiento contra-corrosión
- Soporte: Fundición gris G20 con tratamiento contra-corrosión
- Rodete: Fundición gris G20 con tratamiento contra-corrosión (De tecnopolimero para las KA 80=100)
- Eje de la bomba: de acero Inox AISI304 (Aisi 420 F para las KA 80=100)
- Cierre mecánico: De cerámica y grafito

MOTOR

Los motores de accionamiento son asíncrono de jaula de ardilla cerrados, ventilados externamente

- Para los modelos monofásicos, protección térmica y condensador incorporado
- Para los modelos trifásicos de la protección se encarga el usuario y el equipo recomendado de acuerdo con las normas
- Aislamiento de Clase F – funcionamiento S1- proteccion IP44
- Proteccion IP54 para el terminal

50 Hz - min⁻¹ ~ 2900

TIPO TYPE		Potenza nominale Nominal power		Potenza assorbita Input power [W]		Condensatore Capacitor 450 V max	Corrente assorbita Input current [A]			Portata - Capacity													
Monofase Single-phase	Trifase Three-phase	kW	HP	a	b	[μF]	1~230V	3~230V	3~400V	Q [m ³ /h]	Q [l/s]	Prevalenza (m C.A.) Total head (m W.C.)											
a	b									H [m]													
KA 80 M	KA 80 T	0,6	0,8	890	790	16	4,2	2,8	1,6	0	3	6	9	12	16,5	18	17,0	16,3	14,5	13,0	11,0	6	
KA 100 M	KA 100 T	0,75	1	1130	1010	18	5,5	3,5	2	0	50	100	150	200	275	300	20,0	18,5	17,0	15,2	13,0	8,6	6

a) ~ Monofase 230 V

b) ~ Trifase 230/400 V

TIPO TYPE		Potenza nominale Nominal power		Potenza assorbita Input power [W]		Condensatore Capacitor 450 V max	Corrente assorbita Input current [A]			Portata - Capacity												
Monofase Single-phase	Trifase Three-phase	kW	HP	a	b	[μF]	1~230V	3~230V	3~400V	Q [m ³ /h]	Q [l/s]	Prevalenza (m C.A.) Total head (m W.C.)										
a	b									H [m]												
KA 150 M	KA 150 T	1,1	1,5	2060	2020	31,5	9	6	3,5	0	6	12	18	24	27	19,0	18,5	18,0	16,5	13,5	11	
KA 200 M	KA 200 T	1,5	2	2370	2350	40	11,5	7,2	4,2	0	100	200	300	400	450	20,5	21,0	20,5	19,0	16,0	14	

a) ~ Monofase 230 V

b) ~ Trifase 230/400 V

60 Hz - min⁻¹ ~ 3400

TIPO TYPE		Potenza nominale Nominal power		Potenza assorbita Input power [W]		Condensatore Capacitor 450 V max	Corrente assorbita Input current [A]				Portata - Capacity													
Monofase Single-phase	Trifase Three-phase	kW	HP	a	b	[μF]	1~115V	1~220V	3~220V	3~380V	Q [m ³ /h]	Q [l/s]	Prevalenza (m C.A.) Total head (m W.C.)											
a	b										H [m]													
KA 80 M	KA 80 T	0,6	0,8	870	760	18	8,5	4,5	3	1,6	0	3	6	9	12	16,5	18	18,0	17,0	15,8	13,9	12,0	8,1	6,1
KA 100 M	KA 100 T	0,75	1	1110	980	20	10,5	5,8	4,1	2,3	0	50	100	150	200	275	300	22,0	21,0	19,8	18,4	16,5	13	11,9

a) ~ Monofase 115/220V

b) ~ Trifase 230/400 V

TIPO TYPE		Potenza nominale Nominal power		Potenza assorbita Input power [W]		Condensatore Capacitor 450 V max	Corrente assorbita Input current [A]			Portata - Capacity												
Monofase Single-phase	Trifase Three-phase	kW	HP	a	b	[mF]	1~220V	3~220V	3~380V	Q [m ³ /h]	Q [l/s]	Prevalenza (m C.A.) Total head (m W.C.)										
a	b									H [m]												
KA 150 M	KA 150 T	1,1	1,5	2040	1990	36	9,5	5,7	3,2	0	6	12	18	24	27	21,0	20,8	19,9	17,5	13,7	11,3	
KA 200 M	KA 200 T	1,5	2	2330	2320	40	12,5	7	4,6	0	100	200	300	400	450	24,0	23,8	23,0	22,0	19,0	17	

a) ~ Monofase 220 V

b) ~ Trifase 220/380 V

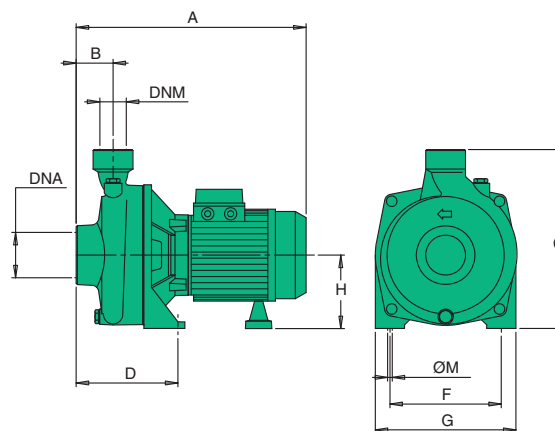

TIPO TYPE	DIMENSIONI [mm] DIMENSIONS [mm]								IMBALLO [mm] PACKING [mm]			PESO WEIGHT [kg]		
	A	B	C	D	F	G	Ø	H	DNA	DNM	A		L	P
KA 80	288	40	237	114	140	180	9	97	1" 1/2 G	1" 1/2 G	300	200	340	14,2
KA 100	288	40	237	114	140	180	9	97	1" 1/2 G	1" 1/2 G	300	200	340	14,6
KA 150	349	42	260	136	149	199	11	110	1" 1/2 G	1" 1/2 G	320	220	360	21
KA 200	349	42	260	136	149	199	11	110	1" 1/2 G	1" 1/2 G	320	220	360	23

min⁻¹ ~ 2900

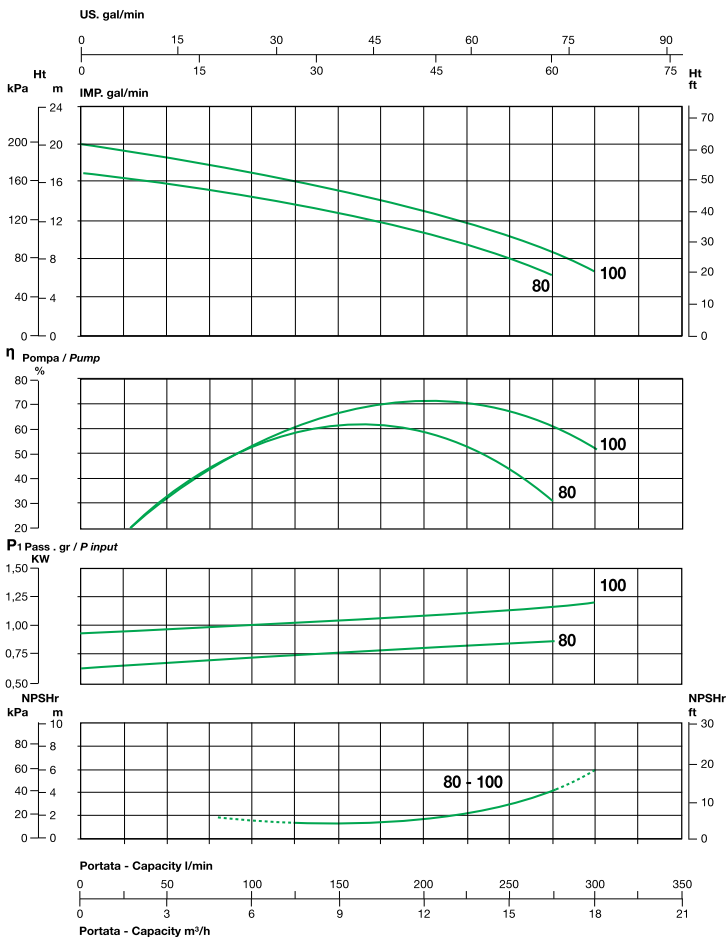

min⁻¹ ~ 3400

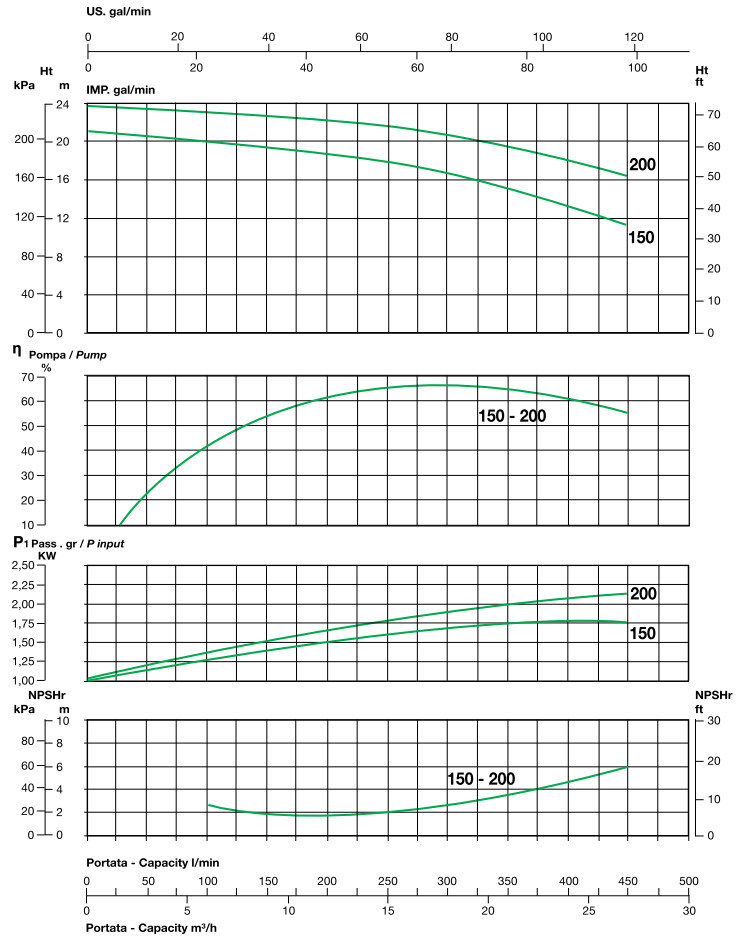
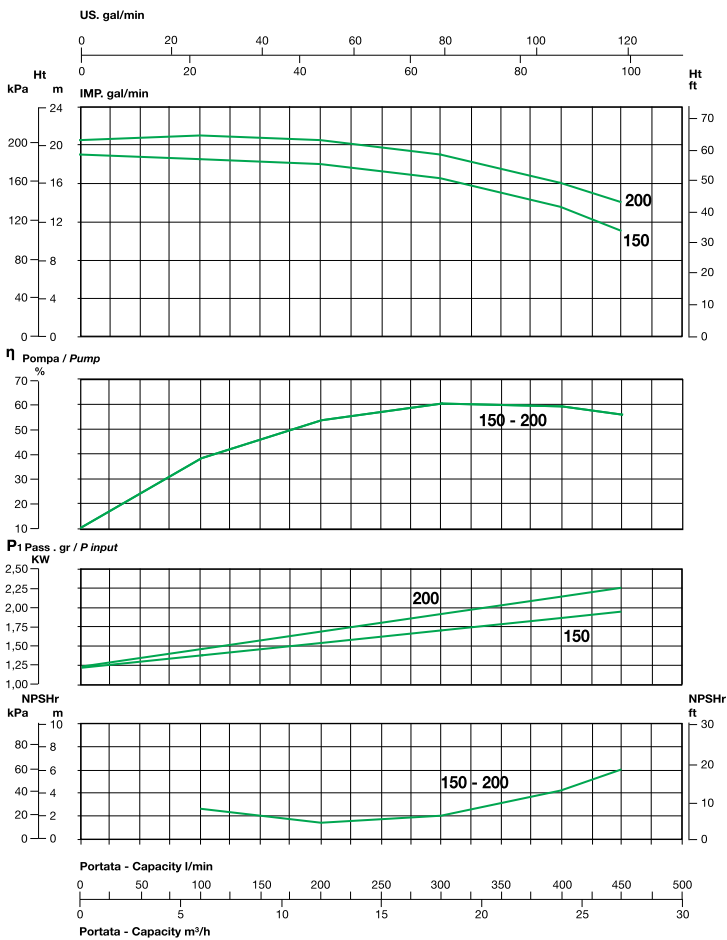
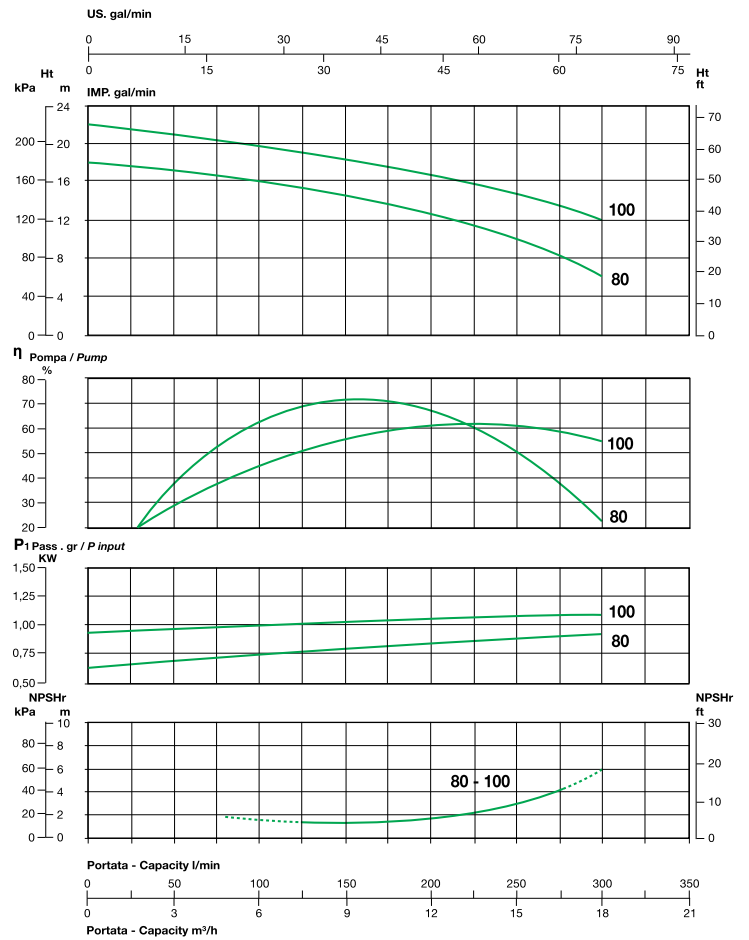

"KC"



NOMENCLATURA PARTI DI RICAMBIO
SPARE PARTS LIST
NOMENCLATURE PIECES DE RECHANGE
NOMENCLATURA REPUESTOS

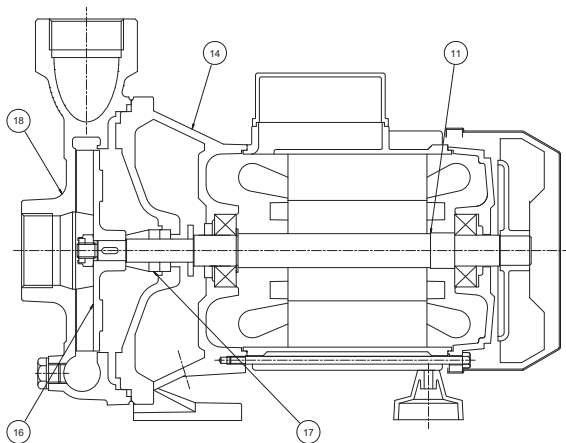

- 11** Albero con rotore – Pump shaft + rotor
Arbre + rotor – Eje rotor
- 14** Supporto mandata – Outlet bracket
Support envoyée – Soporte entrega
- 16** Girante – Impeller
Turbine – Impulsor
- 17** Tenuta meccanica – Mechanical seal
Garniture mécanique – Cierre mecánico
- 18** Corpo pompa – Pump body
Corp de pompe – Cuerpo bomba

ELETTROPOMPE CENTRIFUGHE MONOGIRANTE 1"1/2

Le elettropompe centrifughe monogiranti della serie KC sono state progettate per pompare liquidi puliti senza parti abrasive, senza corpi solidi in sospensione, non esplosivi o aggressivi per i materiali della pompa

- Temperatura max. del liquido fino a 35 °C per uso domestico (CEI EN 60335-2-41) o 90 °C per altri usi e temperatura ambiente fino a 40 °C.
- Portate fino a 21 m³/h.
- Prevalenze fino a ~ 35 m.

CARATTERISTICHE COSTRUTTIVE

- Corpo pompa: ghisa G20 con trattamento anticorrosione
- Supporto motore: ghisa G20 con trattamento anticorrosione
- Girante: ottone stampato UNI-EN 12165
- Albero pompa: acciaio inox Aisi 304
- Tenuta meccanica: carbone-ceramica

MOTORE

I motori di comando sono del tipo asincrono a gabbia di scoiattolo chiusi, a ventilazione esterna

- Motoprotettore incorporato e condensatore permanentemente inserito per i tipi monofasi
- La protezione del motore nella versione trifase è a cura del cliente e si raccomandano apparecchiature in accordo con le norme vigenti
- Isolamento classe F –servizio S1- grado di protezione IP 44
- Protezione morsettiera IP 54

ÉLECTROPOMPES CENTRIFUGES À UNE ROUE 1"1/2

Les électropompes centrifuges à une roue de la série KC ont été conçues pour pomper des liquides propres sans parties abrasives, sans corps liquides en suspension, non explosifs ou agressifs pour les matériaux de la pompe

- Température max. du liquide jusqu'à 35 °C pour utilisation domestique (CEI EN 60335-2-41) ou 90 °C pour d'autres utilisations et température ambiante jusqu'à 40 °C.
- Plage d'utilisation jusqu'à 21 m³/h.
- Hauteur manométrique jusqu'à ~ 35 m.

CARACTERISTIQUES DE CONSTRUCTION

- Corps de pompe : En fonte G20 avec traitement anti-corrosion
- Lanterne: En fonte G20 avec traitement anti-corrosion
- Turbine: laiton étampé UNI-EN 12165
- Abre de pompe: acier inox Aisi 304
- Garniture mécanique: Carbone dur - Céramique

MOTOR

Le moteurs sont asynchrones à cage d'écurueil fermés à ventilation extérieure monofásicos,

- Pour le modèles monophasé son avec protection thermique et condensateur connecté en permanence
- Pour les modèles triphasés, la protection est à la charge de l'utilisateur. A recommandé l'équipement conformément à la réglementation
- A Classe d'isolation F - service S 1 – protection IP44
- Protection IP54 dans le terminal

CENTRIFUGAL ELECTRIC PUMPS ONE IMPELLER 1"1/2

The close-coupled centrifugal electric pumps with one impeller series KC have been designed to pump clear liquids, without abrasives and suspended solids, non-explosive or aggressive for the pump's materials

- Liquid temperature not higher than 35 °C for domestic use (CEI EN 60335-2-41) or 90 °C for other use, while the ambient temperature must not be higher than 40 °C
- Flow rate up to ~ 21 m³/h
- Heads up to ~ 35 m

TECHNICAL FEATURES

- Pump body: cast iron G20 with anti-corrosive coating
- Motor bracket: cast iron G20 with anti-corrosive coating
- Impeller: stamped brass UNI-EN 12165
- Pump shaft: stainless steel Aisi 304
- Mechanical seal: carbon-ceramics

MOTOR

The control motors are asynchronous, squirrel cage-type, closed, with external ventilation

- Incorporated motor protection and capacitor always on, for single-phase models
- The motor protection for three-phase models must be installed by the customer. Equipment compliant with current standards should be used
- Class of insulation:F-service:S1-Degree of protection: IP 44
- Terminal board protection: IP 54

ELECTROBOMBAS CENTRÍFUGAS MONOIMPULSOR 1"1/2

Las electrobombas centrifugas con monoimpulsor de la serie KC han sido proyectadas para bombear líquidos limpios sin partes abrasivas, sin cuerpos sólidos en suspensión, que no sean explosivos ni agresivos para los materiales de la bomba.

- Temperatura max. del líquido hasta 35 °C para uso doméstico (CEI EN 60335-2-41) o 90 °C para otros usos y temperatura ambiente hasta 40 °C.
- Caudal hasta 21 m³/h.
- Alturas hasta ~ 35 m.

CARACTERÍSTICAS DE CONSTRUCCIÓN

- Cuerpo de bomba: Fundición gris G20 con tratamiento contra-corrosión
- Soporte: Fundición gris G20 con tratamiento contra-corrosión
- Rodete: De latón UNI-EN 12165
- Eje de la bomba: de acero Inox AISI304
- Cierre mecánico: De cerámica y grafito

MOTOR

Los motores de accionamiento son asíncrono de jaula de ardilla cerrados, ventilados externamente

- Para los modelos monofásicos, protección térmica y condensador incorporado
- Para los modelos trifásicos de la protección se encarga el usuario y el equipo recomendado de acuerdo con las normas
- Aislamiento de Clase F – funcionamiento S1- protección IP44
- Protección IP54 para el terminal

50 Hz - min⁻¹ ~ 2900

TIPO TYPE		Potenza nominale Nominal power		Potenza assorbita Input power [W]		Condensatore Capacitor 450 V max	Corrente assorbita Input current [A]			Portata - Capacity									
Monofase Single-phase	Trifase Three-phase	kW	HP	a	b	[µF]	1~230V	3~230V	3~400V	Q [m³/h]	0	3	6	9	12	15	18	21	
a	b									Q [l/1']	0	50	100	150	200	250	300	350	
										Prevalenza (m C.A.) Total head (m W.C.)									
										H [m]	24.5	24.3	23.7	22.8	21.5	19.8	17.7	15.2	
											30.1	29.4	28.6	27.4	26.1	24.5	22.7	20.7	
											35.5	34.4	33.0	31.4	29.6	27.5	25.3	22.8	
KC 150 M	KC 150 T	1.1	1.5	1920	1850	31,5	8.5	6.4	3.7										
KC 200 M	KC 200 T	1.47	2	2670	2450	45	11.7	8.3	4.8										
	KC 300 T	2.2	3	-	3030	-	-	8.9	5.1										

a) ~ Monofase 230 V

b) ~ Trifase 230/400 V

60 Hz - min⁻¹ ~ 3400

TIPO TYPE		Potenza nominale Nominal power		Potenza assorbita Input power [W]		Condensatore Capacitor 450 V max	Corrente assorbita Input current [A]			Portata - Capacity									
Monofase Single-phase	Trifase Three-phase	kW	HP	a	b	[µF]	1~220V	3~220V	3~380V	Q [m³/h]	0	3	6	9	12	15	18	21	
a	b									Q [l/1']	0	50	100	150	200	250	300	350	
										Prevalenza (m C.A.) Total head (m W.C.)									
										H [m]	23,3	23,2	23,0	22,5	21,6	20	18,3	16,2	
											30,3	30,0	29,9	29,5	28,4	27,3	25,6	23,7	
											34,6	34,3	34,0	33,4	32,1	30,7	29,0	26,9	
KC 150 M	KC 150 T	1,1	1,5	2065	1250	36	9,6	5,9	3,3										
KC 200 M	KC 200 T	1,47	2	2870	1710	45	13	7,6	4,5										
	KC 300 T	2,2	3	-	3250	-	-	9,1	5,5										

a) ~ Monofase 220 V

b) ~ Trifase 220/380 V

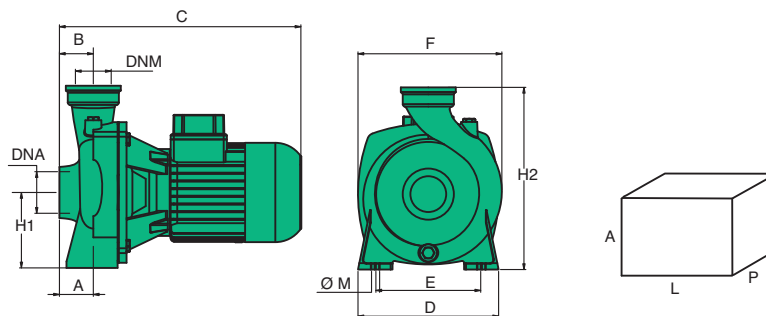

TIPO TYPE	DIMENSIONI [mm] DIMENSIONS [mm]											IMBALLO [mm] PACKING [mm]			PESO WEIGHT [kg]
	A	B	C	D	E	F	Ø M	H1	H2	DNA	DNM	A	L	P	
KC 150	33	54	370	223	160	230	11	118	292	1"1/2	1"1/2	350	430	240	24.5
KC 200	33	54	382	223	160	230	11	118	292	1"1/2	1"1/2	350	430	240	25.4
KC 300	33	54	382	223	160	230	11	118	292	1"1/2	1"1/2	350	440	260	27

min⁻¹ ~ 2900

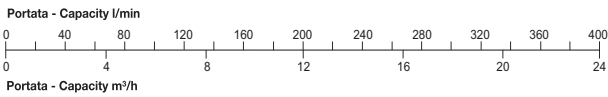
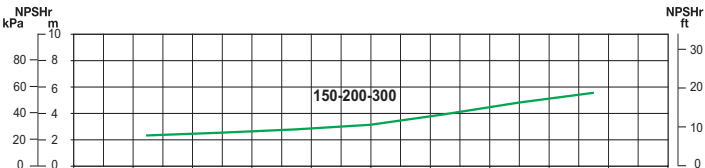
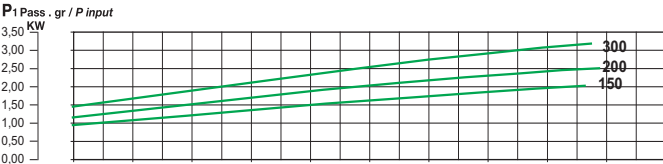
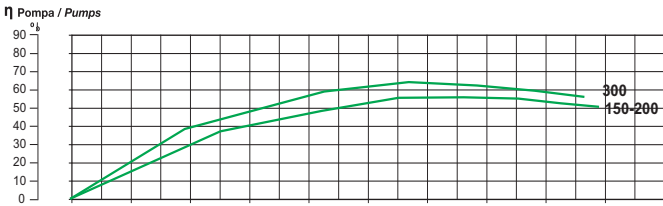
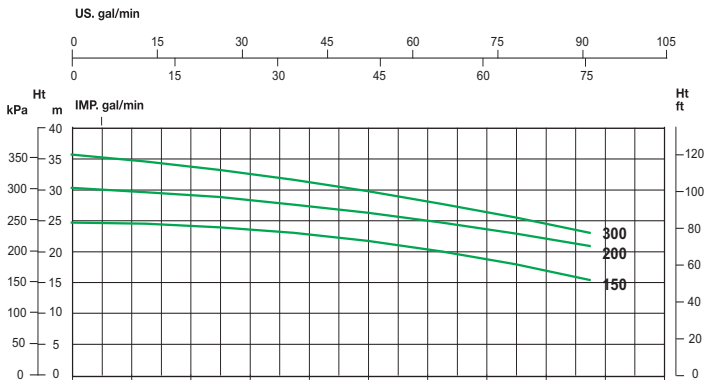

min⁻¹ ~ 3400

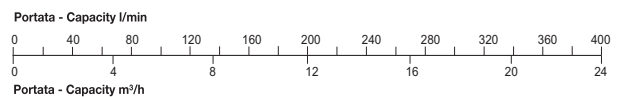
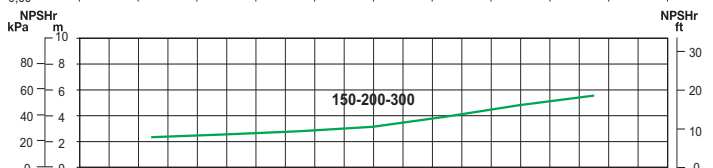
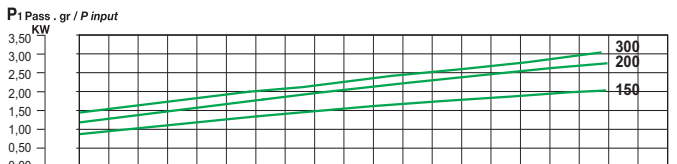
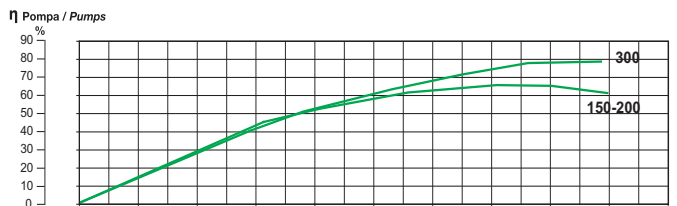
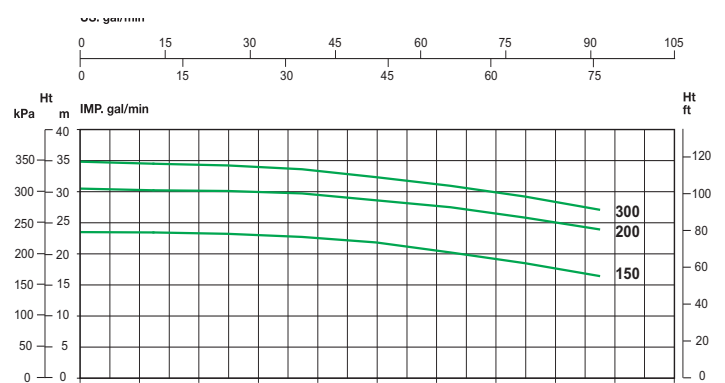

"KP"

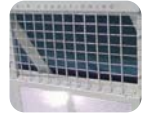

NOMENCLATURA PARTI DI RICAMBIO
SPARE PARTS LIST
NOMENCLATURE PIECES DE RECHANGE
NOMENCLATURA REPUESTOS

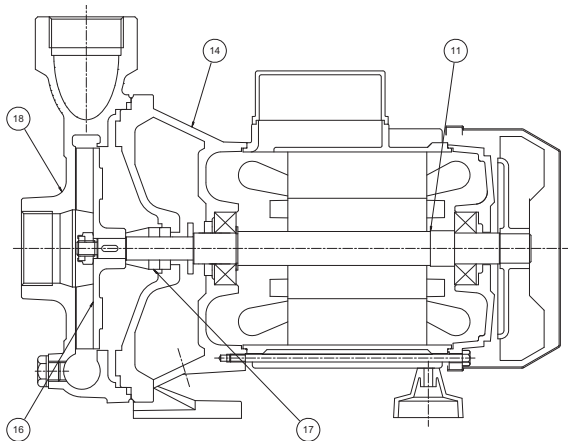

- 11** Albero con rotore – Pump shaft + rotor
Arbre + rotor – Eje rotor
- 14** Supporto mandata – Outlet bracket
Support envoyée – Soporte entrega
- 16** Girante – Impeller
Turbine – Impulsor
- 17** Tenuta meccanica – Mechanical seal
Garniture mécanique – Cierre mecánico
- 18** Corpo pompa – Pump body
Corp de pompe – Cuerpo bomba

ELETTROPOMPE CENTRIFUGHE MONOGIRANTE 2"

Le elettropompe centrifughe monogiranti a media portata della serie KP sono state progettate per pompare liquidi puliti senza parti abrasive, senza corpi solidi in sospensione, non esplosivi o aggressivi per i materiali della pompa

- Temperatura max. del liquido fino a 35 °C per uso domestico (CEI EN 60335-2-41) o 90 °C per altri usi e temperatura ambiente fino a 40 °C.
- Portate fino a 36 m³/h.
- Prevalenze fino a ~ 30 m.

CARATTERISTICHE COSTRUTTIVE

- Corpo pompa: ghisa G20 con trattamento anticorrosione
- Supporto motore: ghisa G20 con trattamento anticorrosione
- Girante: ottone stampato UNI-EN 12165 (Technopolimero per KP 80-100-120)
- Albero pompa: acciaio inox Aisi 304 (Aisi 420 F per KP 80-100-120)
- Tenuta meccanica: carbone-ceramica

MOTORE

I motori di comando sono del tipo asincrono a gabbia di scoiattolo chiusi, a ventilazione esterna

- Motoprotettore incorporato e condensatore permanentemente inserito per i tipi monofasi
- La protezione del motore nella versione trifase è a cura del cliente e si raccomandano apparecchiature in accordo con le norme vigenti
- Isolamento classe F – servizio S1- grado di protezione IP 44
- Protezione morsettiera IP 54

ÉLECTROPOMPES CENTRIFUGES À UNE ROUE 2"

Les électropompes centrifuges à une roue à débit moyen de la série KP ont été conçues pour pomper des liquides propres sans parties abrasives, sans corps liquides en suspension, non explosifs ou agressifs pour les matériaux de la pompe

- Température max. du liquide jusqu'à 35 °C pour utilisation domestique (CEI EN 60335-2-41) ou 90 °C pour d'autres utilisations et température ambiante jusqu'à 40 °C.
- Plage d'utilisation jusqu'à 36 m³/h.
- Hauteur manométrique jusqu'à ~ 30 m.

CARACTERISTIQUES DE CONSTRUCTION

- Corps de pompe : En fonte G20 avec traitement anti-corrosion
- Lanterne: En fonte G20 avec traitement anti-corrosion
- Turbine: laiton étampé UNI-EN 12165
- Abre de pompe: acier inox Aisi 304
- Garniture mécanique: Carbone dur - Céramique

MOTOR

Le moteurs sont asynchrones à cage d'écurieil fermés à ventilation extérieure monofásicos,

- Pour le modèles monophasé son avec protection thermique et condensateur connecté en permanence
- Pour les modèles triphasés, la protection est à la charge de l'utilisateur. A recommandé l'équipement conformément à la réglementation
- A Classe d'isolation F - service S 1 – protection IP44
- Protection IP54 dans le terminal

CENTRIFUGAL ELECTRIC PUMPS ONE IMPELLER 2"

The close-coupled centrifugal electric pumps with one impeller medium flow series KP have been designed to pump clean liquids, without abrasives and suspended solids, non-explosive or aggressive for the pump's materials

- Liquid temperature not higher than 35 °C for domestic use (CEI EN 60335-2-41) or 90 °C for other use, while the ambient temperature must not be higher than 40 °C
- Flow rate up to ~ 36 m³/h
- Heads up to ~ 30 m

TECHNICAL FEATURES

- Pump body: cast iron G20 with anti-corrosive coating
- Motor bracket: cast iron G20 with anti-corrosive coating
- Impeller: stamped brass UNI-EN 12165 (Techno-polymer for KP 80-100-120)
- Pump shaft: stainless steel Aisi 304 (Aisi 420 F for KP 80-100-120)
- Mechanical seal: carbon-ceramics

MOTOR

The control motors are asynchronous, squirrel cage-type, closed, with external ventilation

- Incorporated motor protection and capacitor always on, for single-phase models
- The motor protection for three-phase models must be installed by the customer. Equipment compliant with current standards should be used
- Class of insulation:F-service:S1-Degree of protection: IP 44
- Terminal board protection: IP 54

ELECTROBOMBAS CENTRÍFUGAS MONOIMPULSOR 2"

Las electrobombas centrifugas con monoimpulsor de capacidad media de la serie KP han sido proyectadas para bombear líquidos limpios sin partes abrasivas, sin cuerpos sólidos en suspensión, que no sean explosivos ni agresivos para los materiales de la bomba.

- Temperatura max. del líquido hasta 35 °C para uso doméstico (CEI EN 60335-2-41) o 90 °C para otros usos y temperatura ambiente hasta 40 °C.
- Caudal hasta 36 m³/h.
- Alturas hasta ~ 30 m.

CARACTERÍSTICAS DE CONSTRUCCIÓN

- Cuerpo de bomba: Fundición gris G20 con tratamiento contra-corrosión
- Soporte: Fundición gris G20 con tratamiento contra-corrosión
- Rodete: De latón UNI-EN 12165
- Eje de la bomba: de acero Inox AISI304
- Cierre mecánico: De cerámica y grafito

MOTOR

Los motores de accionamiento son asíncrono de jaula de ardilla cerrados, ventilados externamente

- Para los modelos monofásicos, protección térmica y condensador incorporado
- Para los modelos trifásicos de la protección se encarga el usuario y el equipo recomendado de acuerdo con las normas
- Aislamiento de Clase F – funcionamiento S1- protección IP44
- Protección IP54 para el terminal

50 Hz - min⁻¹ ~ 2900

TIPO TYPE		Potenza nominale Nominal power		Potenza assorbita Input power [W]		Condensatore Capacitor 450 V max	Corrente assorbita Input current [A]			Portata - Capacity						
Monofase Single-phase	Trifase Three-phase	kW	HP	a	b		[μF]	1~230V	3~230V	3~400V	Q [m ³ /h]	Q [l/s]	Prevalenza (m C.A.) Total head (m W.C.)			
a	b									H [m]						
KP 80 M	KP 80 T	0,59	0,8	960	860	16	4,5	3	1,7	12,0 11,8 11,0 9,0 5,5						
KP 100 M	KP 100 T	0,75	1	1190	1010	18	5,4	3,5	2	13,5 13,3 12,3 10,3 7,5						
KP 120 M	KP 120 T	0,9	1,2	1340	1210	25	6	4	2,3	15,0 15,0 14,0 12,0 9,5						

a) ~ Monofase 230 V

b) ~ Trifase 230/400 V

TIPO TYPE		Potenza nominale Nominal power		Potenza assorbita Input power [W]		Condensatore Capacitor 450 V max	Corrente assorbita Input current [A]			Portata - Capacity												
Monofase Single-phase	Trifase Three-phase	kW	HP	a	b		[μF]	1~230V	3~230V	3~400V	Q [m ³ /h]	Q [l/s]	Prevalenza (m C.A.) Total head (m W.C.)									
a	b									H [m]												
KP 150 M	KP 150 T	1,1	1,5	2200	2450	31,5	8,5	6,4	3,7	21,7	20,9	20,3	19,7	18,9	18,1	17,1	15,9	14,5	12	9,5	5,5	
KP 200 M	KP 200 T	1,47	2	2490	2300	45	11,5	7,5	4,4	24,3	24,0	23,5	22,9	22,0	21	19,8	18,4	16,7	14,9	12,7	10,5	
KP 300 M	KP 300 T	2,2	3	3000	3150	55	12,7	8,9	5,2	29,5	28,4	27,7	27,1	26,3	25,2	23,7	22,1	20,2	17,4	14,7	11,9	

a) ~ Monofase 230 V

b) ~ Trifase 230/400 V

60 Hz - min⁻¹ ~ 3400

TIPO TYPE		Potenza nominale Nominal power		Potenza assorbita Input power [W]		Condensatore Capacitor 450 V max	Corrente assorbita Input current [A]			Portata - Capacity						
Monofase Single-phase	Trifase Three-phase	kW	HP	a	b		[μF]	1~220 V	3~220 V	3~380 V	Q [m ³ /h]	Q [l/s]	Prevalenza (m C.A.) Total head (m W.C.)			
a	b									H [m]						
KP 80 M	KP 80 T	0,59	0,8	980	890	16	3,8	3,1	1,8	12 11,9 11,1 9,3 6,5						
KP 100 M	KP 100 T	0,75	1	1050	980	20	4	4	2,3	12,8 13 12,3 10,4 7,5						
KP 120 M	KP 120 T	0,9	1,2	1300	1220	25,0	6,1	4,3	2,5	14,0 14,0 13,2 11,3 8,6						

a) ~ Monofase 220 V

b) ~ Trifase 220/380 V

TIPO TYPE		Potenza nominale Nominal power		Potenza assorbita Input power [W]		Condensatore Capacitor 450 V max	Corrente assorbita Input current [A]			Portata - Capacity												
Monofase Single-phase	Trifase Three-phase	kW	HP	a	b		[μF]	1~220 V	3~220 V	3~380 V	Q [m ³ /h]	Q [l/s]	Prevalenza (m C.A.) Total head (m W.C.)									
a	b									H [m]												
KP 150 M	KP 150 T	1,1	1,5	2160	1450	36	10	6,5	3,9	20,6	19,9	19,3	18,8	18,0	17,2	16,3	14,7	13,1	11,4	8,3	4,3	
KP 200 M	KP 200 T	1,47	2	2500	1680	45	11,5	7,6	4,4	23,4	22,7	22,3	22,0	21,0	20,3	19	17,4	15,6	13	9,7	6,4	
KP 300 M	KP 300 T	2,2	3	3000	2280	55	13,9	10,8	6	27,6	26,9	26,3	25,6	24,7	23,7	22,5	21,1	19,7	18,0	15,3	9,8	

a) ~ Monofase 220 V

b) ~ Trifase 220/380 V

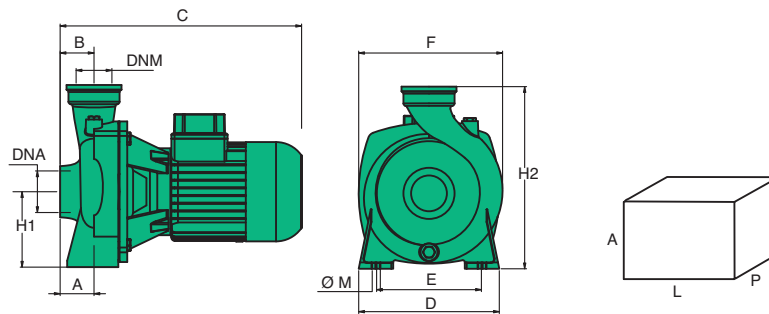

TIPO TYPE	DIMENSIONI [mm] DIMENSIONS [mm]											IMBALLO [mm] PACKING [mm]			PESO WEIGHT [kg]
	A	B	C	D	E	F	Ø M	H1	H2	DNA	DNM	A	L	P	
KP 80	125	45	305	180	145	185	9	97	247	2"	2"	280	200	330	14,2
KP 100	125	45	305	180	145	185	9	97	247	2"	2"	280	200	330	14,6
KP 120	125	45	305	180	145	185	9	97	247	2"	2"	280	200	330	15,4
KP 150	20	53	369	224	160	228	11	118	290	2"	2"	350	450	250	23,2
KP 200	20	53	383	224	160	228	11	118	290	2"	2"	350	450	250	27,6
KP 300	20	53	383	224	160	228	11	118	290	2"	2"	350	450	250	28,8

min⁻¹ ~ 2900

min⁻¹ ~ 3400

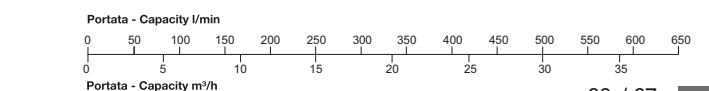
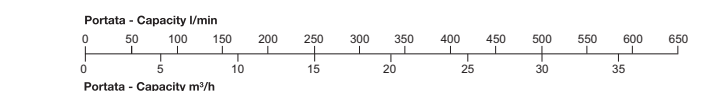
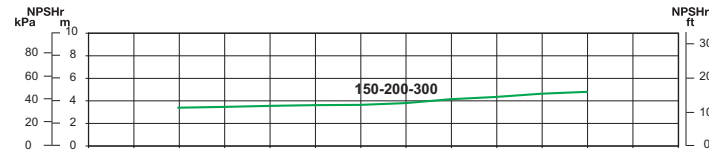
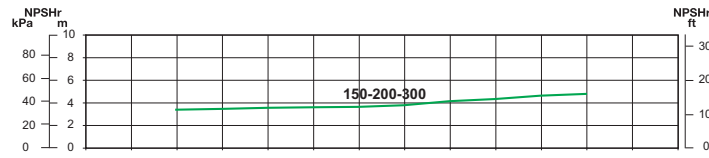
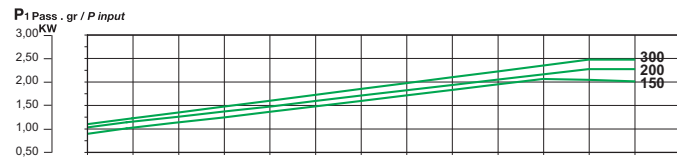
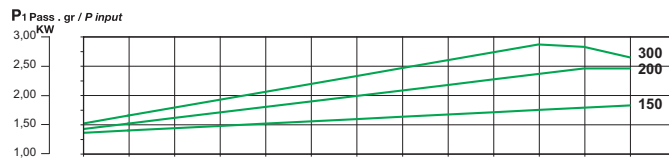
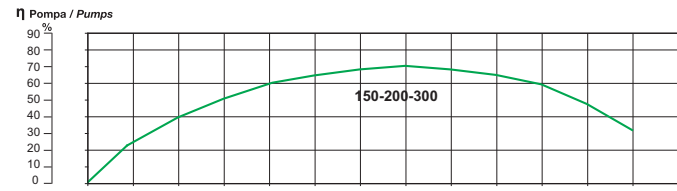
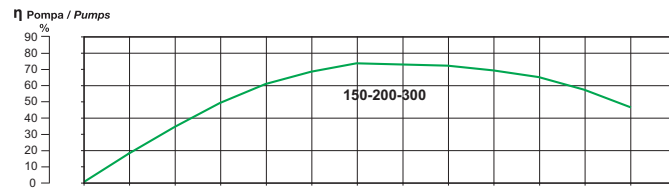
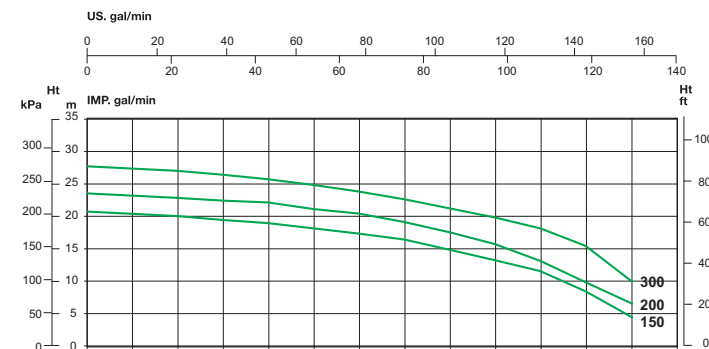
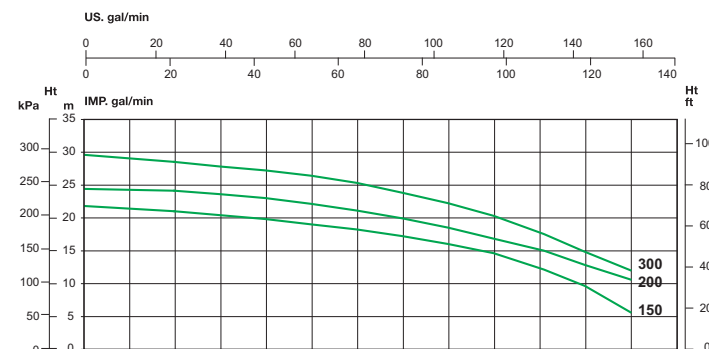
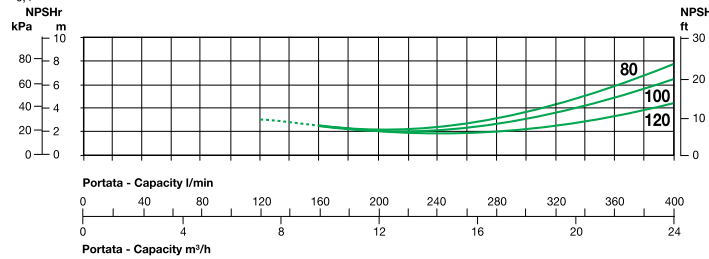
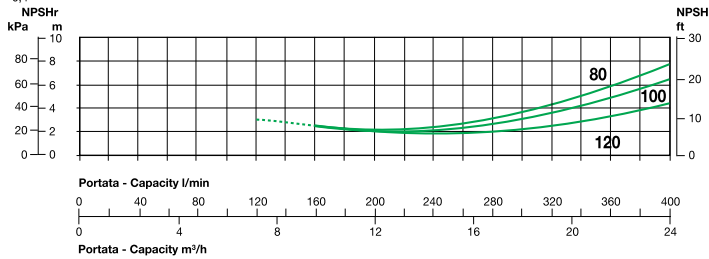
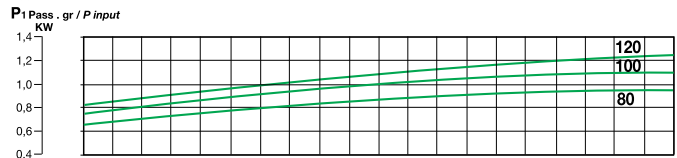
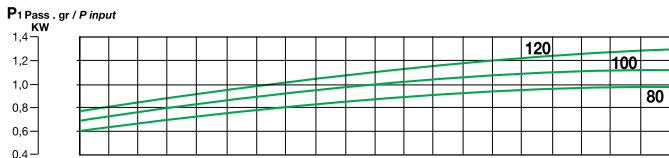
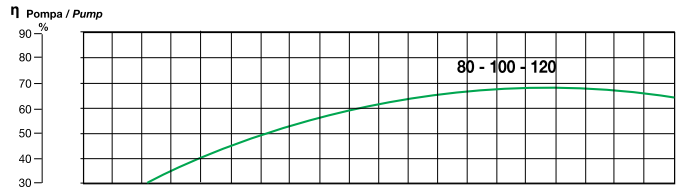
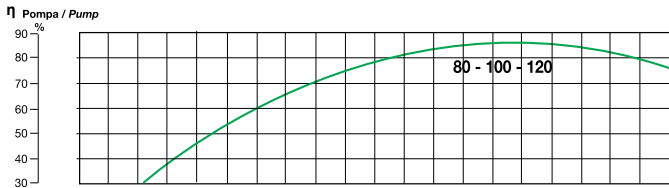
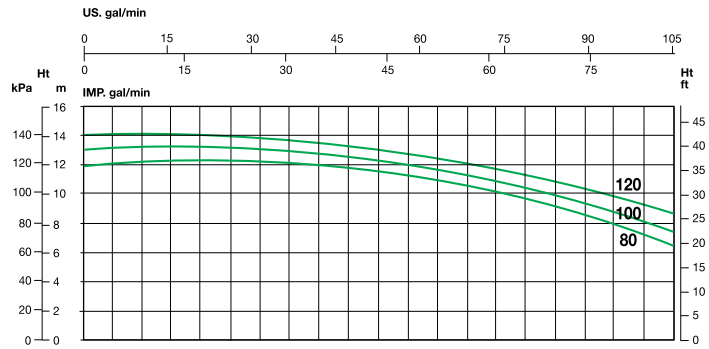
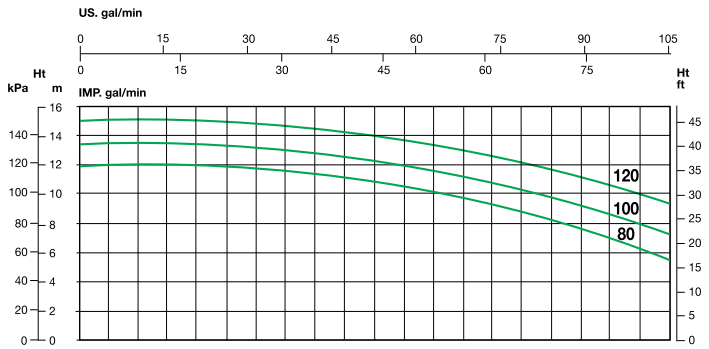

"KL"



NOMENCLATURA PARTI DI RICAMBIO
SPARE PARTS LIST
NOMENCLATURE PIECES DE RECHANGE
NOMENCLATURA REPUESTOS

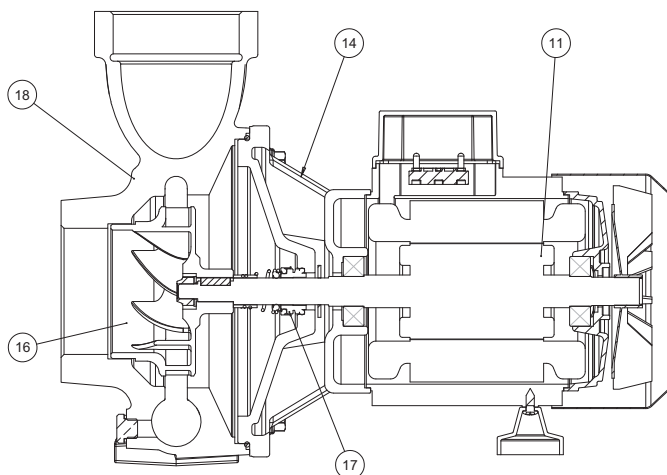

- 11** Albero con rotore – Pump shaft + rotor
Arbre + rotor – Eje rotor
- 14** Supporto mandata – Outlet bracket
Support envoyée – Soporte entrega
- 16** Girante – Impeller
Turbine – Impulsor
- 17** Tenuta meccanica – Mechanical seal
Garniture mécanique – Cierre mecánico
- 18** Corpo pompa – Pump body
Corp de pompe – Cuerpo bomba

ELETTROPOMPE CENTRIFUGHE MONOGIRANTE 3"

Le elettropompe centrifughe monogiranti ad alta portata della serie KL sono state progettate per pompare liquidi puliti senza parti abrasive, senza corpi solidi in sospensione, non esplosivi o aggressivi per i materiali della pompa

- Temperatura max. del liquido fino a 35 °C per uso domestico (CEI EN 60335-2-41) o 90 °C per altri usi e temperatura ambiente fino a 40 °C.
- Portate fino a 72 m³/h.
- Prevalenze fino a ~ 17 m.

CARATTERISTICHE COSTRUTTIVE

- Corpo pompa: ghisa G20 con trattamento anticorrosione
- Supporto motore: ghisa G20 con trattamento anticorrosione
- Girante: ottone stampato UNI-EN 12165
- Albero pompa: acciaio inox Aisi 304
- Tenuta meccanica: carbone-ceramica

MOTORE

I motori di comando sono del tipo asincrono a gabbia di scoiattolo chiusi, a ventilazione esterna

- Motoprotettore incorporato e condensatore permanentemente inserito per i tipi monofasi
- La protezione del motore nella versione trifase è a cura del cliente e si raccomandano apparecchiature in accordo con le norme vigenti
- Isolamento classe F - servizio S1- grado di protezione IP 44
- Protezione morsettiera IP 54

ÉLECTROPOMPES CENTRIFUGES À UNE ROUE 3"

Les électropompes centrifuges à une roue à haut débit de la série KL ont été conçues pour pomper des liquides propres sans parties abrasives, sans corps liquides en suspension, non explosifs ou agressifs pour les matériaux de la pompe

- Température max. du liquide jusqu'à 35 °C pour utilisation domestique (CEI EN 60335-2-41) ou 90 °C pour d'autres utilisations et température ambiante jusqu'à 40 °C.
- Plage d'utilisation jusqu'à 72 m³/h.
- Hauteur manométrique jusqu'à ~ 17 m.

CARACTERISTIQUES DE CONSTRUCTION

- Corps de pompe : En fonte G20 avec traitement anti-corrosion
- Lanterne: En fonte G20 avec traitement anti-corrosion
- Turbine: laiton étampé UNI-EN 12165
- Abre de pompe: acier inox Aisi 304
- Garniture mécanique: Carbone dur - Céramique

MOTOR

Le moteurs sont asynchrones à cage d'écurueil fermés à ventilation extérieure monofásicos,

- Pour le modèles monophasé son avec protection thermique et condensateur connecté en permanence
- Pour les modèles triphasés, la protection est à la charge de l'utilisateur. A recommandé l'équipement conformément à la réglementation
- A Classe d'isolation F - service S 1 - protection IP44
- Protection IP54 dans le terminal

CENTRIFUGAL ELECTRIC PUMPS ONE IMPELLER 3"

The close-coupled centrifugal electric pumps with one impeller high flow series KL have been designed to pump clean liquids, without abrasives and suspended solids, non-explosive or aggressive for the pump's materials

- Liquid temperature not higher than 35 °C for domestic use (CEI EN 60335-2-41) or 90 °C for other use, while the ambient temperature must not be higher than 40 °C
- Flow rate up to ~ 72 m³/h
- Heads up to ~ 17 m

TECHNICAL FEATURES

- Pump body: cast iron G20 with anti-corrosive coating
- Motor bracket: cast iron G20 with anti-corrosive coating
- Impeller: stamped brass UNI-EN 12165
- Pump shaft: stainless steel Aisi 304
- Mechanical seal: carbon-ceramics

MOTOR

The control motors are asynchronous, squirrel cage-type, closed, with external ventilation

- Incorporated motor protection and capacitor always on, for single-phase models
- The motor protection for three-phase models must be installed by the customer. Equipment compliant with current standards should be used
- Class of insulation:F-service:S1-Degree of protection: IP 44
- Terminal board protection: IP 54

ELECTROBOMBAS CENTRÍFUGAS MONOIMPULSOR 3"

Las electrobombas centrifugas con monoimpulsor de alta capacidad de la serie KL han sido proyectadas para bombear líquidos limpios sin partes abrasivas, sin cuerpos sólidos en suspensión, que no sean explosivos ni agresivos para los materiales de la bomba.

- Temperatura max. del líquido hasta 35 °C para uso doméstico (CEI EN 60335-2-41) o 90 °C para otros usos y temperatura ambiente hasta 40 °C.
- Caudal hasta 72 m³/h.
- Alturas hasta ~ 17 m.

CARACTERÍSTICAS DE CONSTRUCCIÓN

- Cuerpo de bomba: Fundición gris G20 con tratamiento contra-corrosión
- Soporte: Fundición gris G20 con tratamiento contra-corrosión
- Rodete: De latón UNI-EN 12165
- Eje de la bomba: de acero Inox AISI304
- Cierre mecánico: De cerámica y grafito

MOTOR

Los motores de accionamiento son asíncrono de jaula de ardilla cerrados, ventilados externamente

- Para los modelos monofásicos, protección térmica y condensador incorporado
- Para los modelos trifásicos de la protección se encarga el usuario y el equipo recomendado de acuerdo con las normas
- Aislamiento de Clase F - funcionamiento S1- proteccion IP44
- Proteccion IP54 para el terminal

50 Hz - min⁻¹ ~ 2900

TIPO TYPE		Potenza nominale Nominal power		Potenza assorbita Input power [W]		Condensatore Capacitor 450 V max	Corrente assorbita Input current [A]			Portata - Capacity													
Monofase Single-phase	Trifase Three-phase	kW	HP	a	b	[µF]	1~230V	3~230V	3~400V	Q [m ³ /h]	0	12	15	18	21	24	27	30	33	36	42	48	60
a	b									Q [l/1']	0	200	250	300	350	400	450	500	550	600	700	800	1000
KL 150 M	KL 150 T	1.1	1.5	2200	2180	31,5	9.2	7.3	3.8	Prevalenza (m C.A.) Total head (m W.C.)													
KL 200 M	KL 200 T	1.47	2	2400	2180	45	9.8	7.9	4.1	H [m]	13,5	12,7	12,4	12,0	11,6	11,1	10,6	10	9,3	8,6	7	5,2	
KL 300 M	KL 300 T	2.2	3	2980	2920	55	13.1	9.6	4.9		14,9	14,5	14,2	13,8	13,6	13,3	12,8	12,3	11,5	10,9	8,9	6,6	
											17,1	16,5	16,2	15,9	15,6	15,2	14,8	14,3	13,8	13,3	12,0	10,6	7,3

a) ~ Monofase 230 V

b) ~ Trifase 230/400 V

60 Hz - min⁻¹ ~ 3400

TIPO TYPE		Potenza nominale Nominal power		Potenza assorbita Input power [W]		Condensatore Capacitor 450 V max	Corrente assorbita Input current [A]			Portata - Capacity													
Monofase Single-phase	Trifase Three-phase	kW	HP	a	b	[µF]	1~220V	3~220V	3~380V	Q [m ³ /h]	0	12	15	18	21	24	27	30	33	36	42	48	60
a	b									Q [l/1']	0	200	250	300	350	400	450	500	550	600	700	800	1000
KL 150 M	KL 150 T	1,1	1,5	2200	1940	36	10,1	6,9	3,8	Prevalenza (m C.A.) Total head (m W.C.)													
KL 200 M	KL 200 T	1,47	2	2520	2150	45	11,6	7,9	4,5	H [m]	12,2	11,3	11,2	11,1	10,9	10,5	10	9,5	8,9	8,2	6,7	4,6	
KL 300 M	KL 300 T	2,2	3	3220	2930	55	14,7	8,9	5,1		14,8	14,3	14,1	13,8	13,6	13,2	12,7	12,1	11,5	10,8	9,1	7	
											17,9	16,5	16,1	15,6	15,2	14,6	14,1	13,5	12,9	12,2	10,8	8,8	5,7

a) ~ Monofase 220 V

b) ~ Trifase 220/380 V

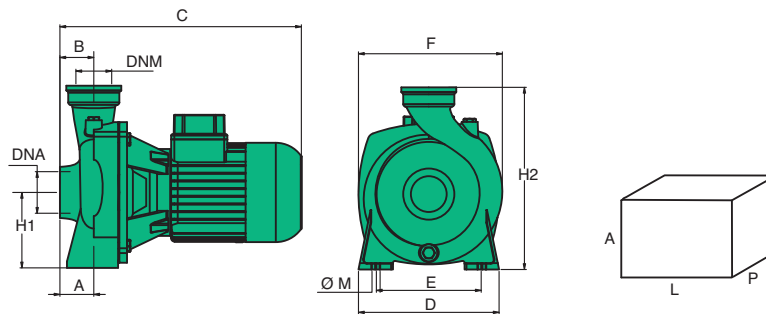

TIPO TYPE	DIMENSIONI [mm] DIMENSIONS [mm]											IMBALLO [mm] PACKING [mm]			PESO WEIGHT [kg]
	A	B	C	D	E	F	Ø M	H1	H2	DNA	DNM	A	L	P	
KL 150	40	80	409	225	160	230	11	118	310	3"	3"	350	450	250	30,6
KL 200	40	80	421	225	160	230	11	118	310	3"	3"	350	450	250	31,8
KL 300	40	80	421	225	160	230	11	118	310	3"	3"	350	450	250	32,8

min⁻¹ ~ 2900

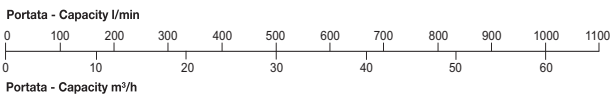
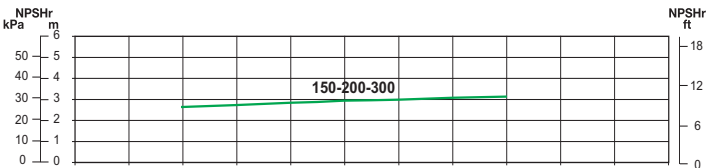
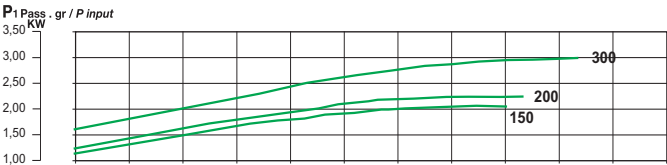
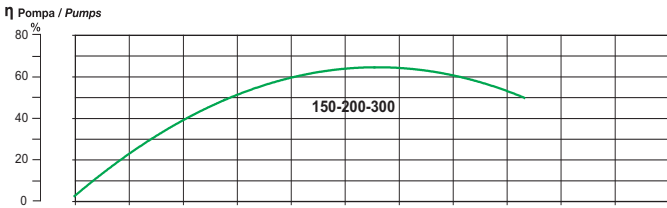
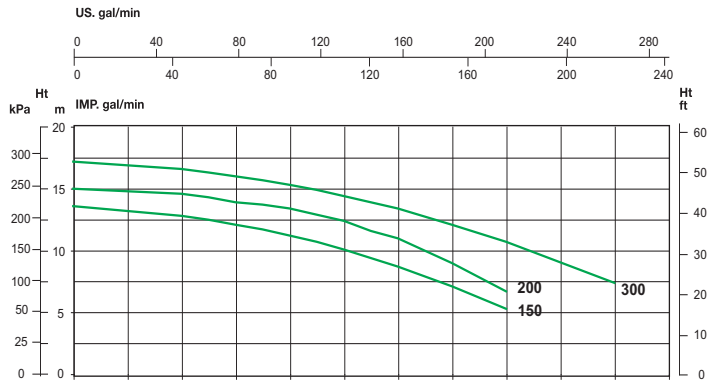

min⁻¹ ~ 3400

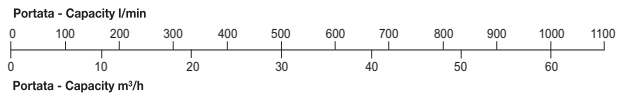
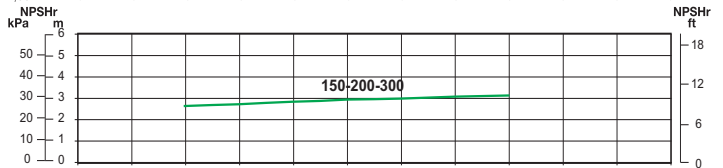
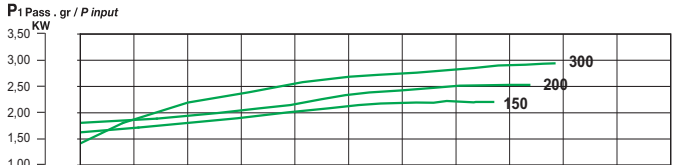
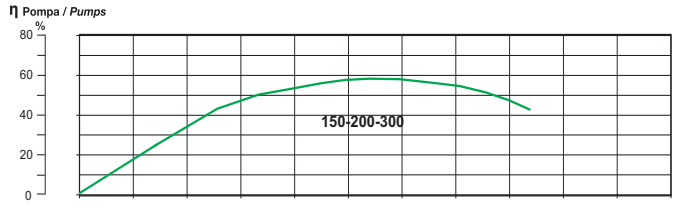
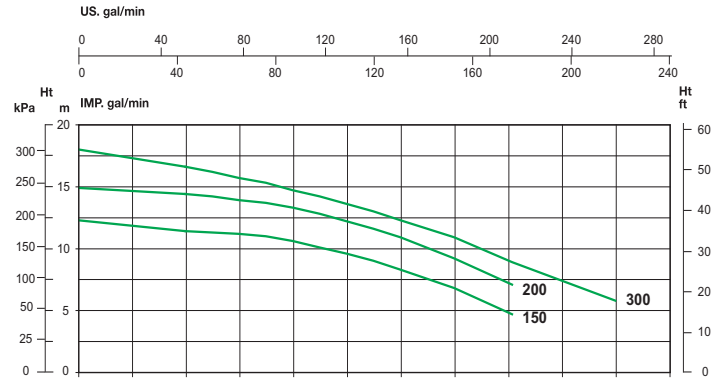

"KXL"



NOMENCLATURA PARTI DI RICAMBIO
SPARE PARTS LIST
NOMENCLATURE PIECES DE RECHANGE
NOMENCLATURA REPUESTOS

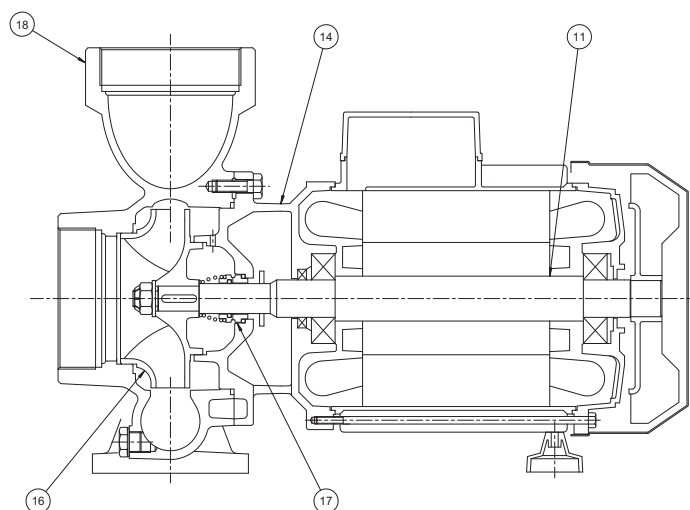

- 11** Albero con rotore – Pump shaft + rotor
Arbre + rotor – Eje rotor
- 14** Supporto mandata – Outlet bracket
Support envoyée – Soporte entrega
- 16** Girante – Impeller
Turbine – Impulsor
- 17** Tenuta meccanica – Mechanical seal
Garniture mécanique – Cierre mecánico
- 18** Corpo pompa – Pump body
Corp de pompe – Cuerpo bomba

ELETTROPOMPE CENTRIFUGHE MONOGIRANTE 4"

Le elettropompe centrifughe monogiranti ad alta portata della serie KXL sono state progettate per pompare liquidi puliti senza parti abrasive, senza corpi solidi in sospensione, non esplosivi o aggressivi per i materiali della pompa

- Temperatura max. del liquido fino a 35 °C per uso domestico (CEI EN 60335-2-41) o 90 °C per altri usi e temperatura ambiente fino a 40 °C.
- Portate fino a ~ 100 m³/h.
- Prevalenze fino a ~ 22.5 m.

CARATTERISTICHE COSTRUTTIVE

- Corpo pompa: ghisa G20 con trattamento anticorrosione
- Supporto motore: ghisa G20 con trattamento anticorrosione
- Girante: Ghisa G20 con trattamento anticorrosione
- Albero pompa: acciaio inox Aisi 304
- Tenuta meccanica: carbone-ceramica

MOTORE

I motori di comando sono del tipo asincrono a gabbia di scoiattolo chiusi, a ventilazione esterna

- Motoprotettore incorporato e condensatore permanentemente inserito per i tipi monofasi
- La protezione del motore nella versione trifase è a cura del cliente e si raccomandano apparecchiature in accordo con le norme vigenti
- Isolamento classe F –servizio S1- grado di protezione IP 44
- Protezione morsettiera IP 54

ÉLECTROPOMPES CENTRIFUGES À UNE ROUE 4"

Les électropompes centrifuges à une roue à haut débit de la série KXL ont été conçues pour pomper des liquides propres sans parties abrasives, sans corps liquides en suspension, non explosifs ou agressifs pour les matériaux de la pompe

- Température max. du liquide jusqu'à 35 °C pour utilisation domestique (CEI EN 60335-2-41) ou 90 °C pour d'autres utilisations et température ambiante jusqu'à 40 °C.
- Plage d'utilisation jusqu'à ~ 100 m³/h.
- Hauteur manométrique jusqu'à ~ 22.5 m.

CARACTERISTIQUES DE CONSTRUCTION

- Corps de pompe : En fonte G20 avec traitement anti-corrosion
- Lanterne: En fonte G20 avec traitement anti-corrosion
- Turbine: En fonte G20 avec traitement anti-corrosion
- Abre de pompe: acier inox Aisi 304
- Garniture mécanique: Carbone dur – Céramique

MOTOR

Le moteurs sont asynchrones à cage d'écurueil fermés à ventilation extérieure monofásicos,

- Pour le modèles monophasé son avec protection thermique et condensateur connecté en permanence
- Pour les modèles triphasés, la protection est à la charge de l'utilisateur. A recommandé l'équipement conformément à la réglementation
- A Classe d'isolation F - service S 1 – protection IP44
- Protection IP54 dans le terminal

CENTRIFUGAL ELECTRIC PUMPS ONE IMPELLER 4"

The close-coupled centrifugal electric pumps with one impeller high flow series KXL have been designed to pump clean liquids, without abrasives and suspended solids, non-explosive or aggressive for the pump's materials

- Liquid temperature not higher than 35 °C for domestic use (CEI EN 60335-2-41) or 90 °C for other use, while the ambient temperature must not be higher than 40 °C
- Flow rate up to ~ 100 m³/h
- Heads up to ~ 22.5 m

TECHNICAL FEATURES

- Pump body: cast iron G20 with anti-corrosive coating
- Motor bracket: cast iron G20 with anti-corrosive coating
- Impeller: cast iron G20 with anti-corrosive coating
- Pump shaft: stainless steel Aisi 304
- Mechanical seal: carbon-ceramics

MOTOR

The control motors are asynchronous, squirrel cage-type, closed, with external ventilation

- Incorporated motor protection and capacitor always on, for single-phase models
- The motor protection for three-phase models must be installed by the customer. Equipment compliant with current standards should be used
- Class of insulation:F-service:S1-Degree of protection IP 44
- Terminal board protection: IP 54

ELECTROBOMBAS CENTRÍFUGAS MONOIMPULSOR 4"

Las electrobombas centrifugas con monoimpulsor de alta capacidad de la serie KXL han sido proyectadas para bombear líquidos limpios sin partes abrasivas, sin cuerpos sólidos en suspensión, que no sean explosivos ni agresivos para los materiales de la bomba.

- Temperatura max. del líquido hasta 35 °C para uso doméstico (CEI EN 60335-2-41) o 90 °C para otros usos y temperatura ambiente hasta 40 °C.
- Caudal hasta ~ 100 m³/h.
- Alturas hasta ~ 22.5 m.

CARACTERÍSTICAS DE CONSTRUCCIÓN

- Cuerpo de bomba: Fundición gris G20 con tratamiento contra-corrosión
- Soporte: Fundición gris G20 con tratamiento contra-corrosión
- Rodete: Fundición gris G20 con tratamiento contra-corrosión
- Eje de la bomba: de acero Inox AISI304
- Cierre mecánico: De cerámica y grafito

MOTOR

Los motores de accionamiento son asíncrono de jaula de ardilla cerrados, ventilados externamente

- Para los modelos monofásicos, protección térmica y condensador incorporado
- Para los modelos trifásicos de la protección se encarga el usuario y el equipo recomendado de acuerdo con las normas
- Aislamiento de Clase F – funcionamiento S1- protección IP44
- Protección IP54 para el terminal

50 Hz - min⁻¹ ~ 2900

TIPO TYPE	Potenza nominale Nominal power		Potenza assorbita Input power	Corrente assorbita Input current [A]		Portata - Capacity									
						Q [m ³ /h]	0	30	45	60	72	96			
						Q [l/s]	0	500	750	1000	1200	1600			
						Prevalenza (m C.A.) Total head (m W.C.)									
b	kW	HP	b	3~ 220 V	3~ 380 V	H [m]	14,5	16,5	15,5	14,0	12,0	6			
KXL 400 T	3	4	3700	11,5	6,5		18,0	20,0	19,0	17,8	15,5	10			
KXL 550 T	4	5,5	5200	19,5	9,3		22,5	24,3	24,0	22,5	20,5	15,0			
KXL 750 T	5,5	7,5	7000	23,4	11,6										

b) ~ Trifase 230/400 V

60 Hz - min⁻¹ ~ 3400

TIPO TYPE	Potenza nominale Nominal power		Potenza assorbita Input power	Corrente assorbita Input current [A]		Portata - Capacity									
						Q [m ³ /h]	0	30	45	60	72	96			
						Q [l/s]	0	500	750	1000	1200	1600			
						Prevalenza (m C.A.) Total head (m W.C.)									
b	kW	HP	b	3~ 220 V	3~ 380 V	H [m]	14,5	16,1	15,7	14,5	12,5	5,3			
KXL 400 T	3	4	3980	13	7,5		18,5	20,0	19,5	18,5	16	10,0			
KXL 550 T	4	5,5	5280	18,5	10,7		22,0	24,7	24,1	23,0	21,3	16,3			
KXL 750 T	5,5	7,5	6600	22	12,7										

b) ~ Trifase 220/380 V

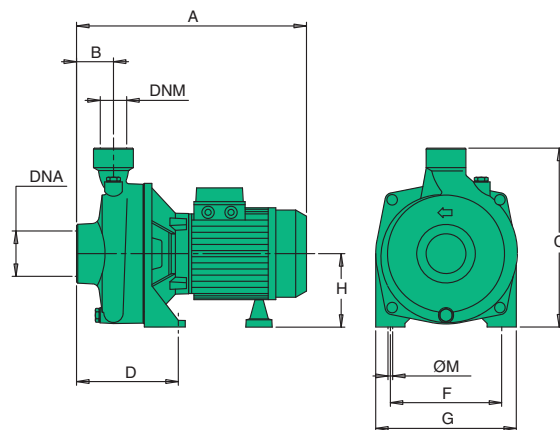

TIPO TYPE	DIMENSIONI [mm] DIMENSIONS [mm]										IMBALLO [mm] PACKING [mm]			PESO WEIGHT [kg]
	A	B	C	D	F	G	Ø	H	DNA	DNM	A	L	P	
KXL 400	447	90	341	139	212	280	14	140	4" G	4" G	380	330	530	40,5
KXL 550	447	90	341	139	212	280	14	140	4" G	4" G	380	330	530	42
KXL 750	505	90	341	139	212	280	14	140	4" G	4" G	380	330	530	52,5

min⁻¹ ~ 2900

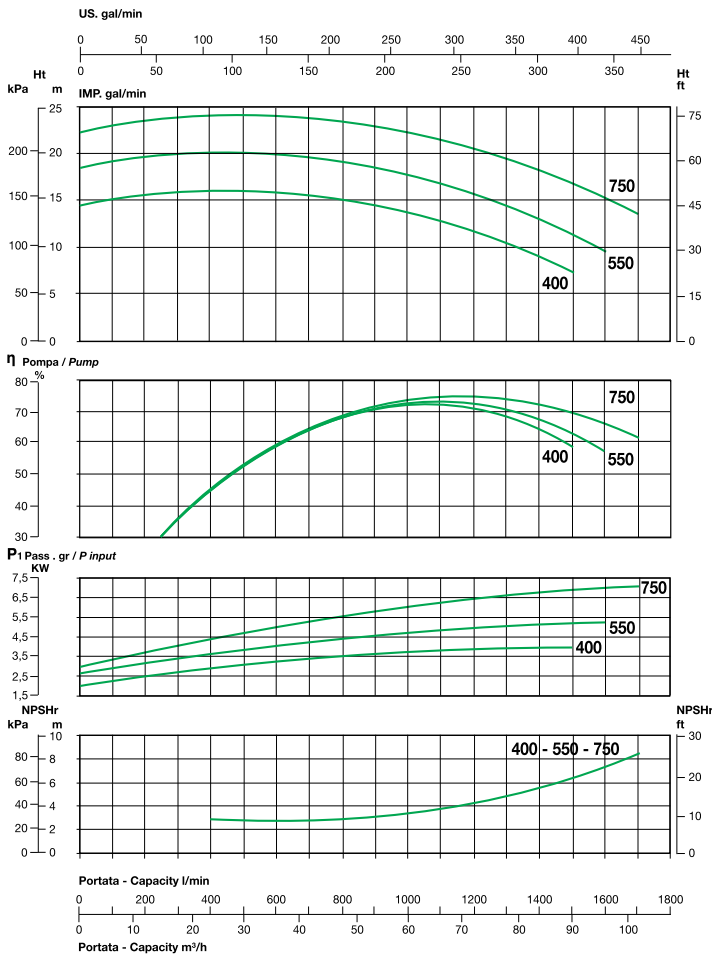

min⁻¹ ~ 3400

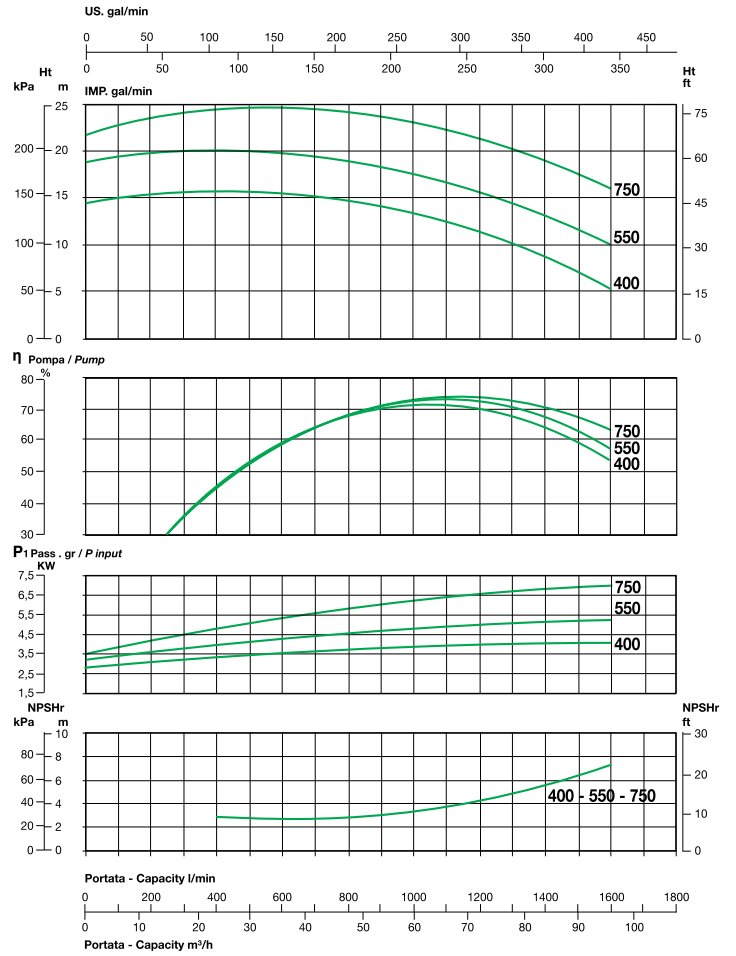

"MC"



NOMENCLATURA PARTI DI RICAMBIO
SPARE PARTS LIST
NOMENCLATURE PIECES DE RECHANGE
NOMENCLATURA REPUESTOS

Giranti in acciaio
Stainless Steel impeller
Roues en acier
Impulsores de acero

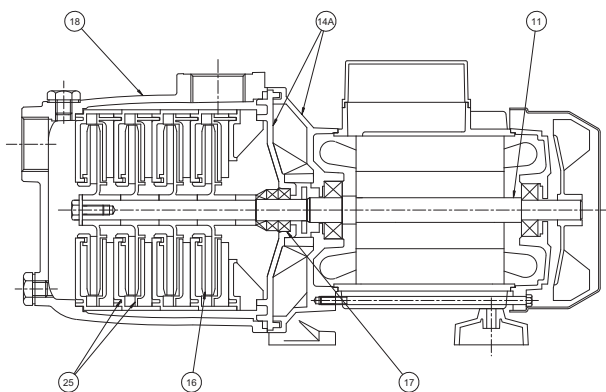

- 11** Albero con rotore – Pump shaft + rotor
Arbre + rotor – Eje rotor
- 14A** Kit supporto – Motor bracket kit
Kit support – Kit soporte
- 16** Girante – Impeller
Turbine – Impulsor
- 17** Tenuta meccanica – Mechanical seal
Garniture mécanique – Cierre mecánico
- 18** Corpo pompa – Pump body
Corp de pompe – Cuerpo bomba
- 25** Diffusore – Diffuser
Diffuseur – Difusor

TOP RANGE

ELETTROPOMPE CENTRIFUGHE MULTISTADIO

Estremamente silenziose ed affidabili le elettropompe centrifughe multistadio della serie MC sono state progettate per pompare da serbatoi o vasche di raccolta, liquidi puliti, senza parti abrasive, senza corpi solidi in sospensione, non esplosivi o aggressivi per i materiali della pompa.

- Temperatura max. del liquido fino a 35 °C per uso domestico (CEI EN 60335-2-41) o 90 °C per altri usi e temperatura ambiente fino a 40 °C.
- Portate fino a 5.5 m³/h.
- Prevalenze fino a ~ 40 m.

CARATTERISTICHE COSTRUTTIVE

- Corpo pompa: ghisa G20 con trattamento anticorrosione
- Supporto motore: alluminio pressofuso UNI 5076
- Disco portatenuta: Tecnopolimero
- Diffusori: tecnopolimero
- Giranti: in acciaio inox Aisi 304
- Albero pompa: acciaio inox Aisi 420F
- Tenuta meccanica: carbone-ceramica

MOTORE

I motori di comando sono del tipo asincrono a gabbia di scoiattolo chiusi, a ventilazione esterna

- Motoprotettore incorporato e condensatore permanentemente inserito per i tipi monofasi
- La protezione del motore nella versione trifase è a cura del cliente e si raccomandano apparecchiature in accordo con le norme vigenti
- Isolamento classe F - servizio S1- grado di protezione IP 44
- Protezione morsettiera IP 54

ÉLECTROPOMPES CENTRIFUGES MULTISTADIO

Extrêmement silencieuses et fiables les électropompes centrifuges multistadio de la série MC ont été conçues pour pomper de réservoirs ou de cuves, des liquides propres, sans parties abrasives, sans corps liquides en suspension, non explosifs ou agressifs pour les matériaux de la pompe.

- Température max. du liquide jusqu'à 35 °C pour utilisation domestique (CEI EN 60335-2-41) ou 90 °C pour d'autres utilisations et température ambiante jusqu'à 40 °C.
- Plage d'utilisation jusqu'à 5.5 m³/h.
- Hauteur manométrique jusqu'à ~ 40 m.

CARACTERISTIQUES DE CONSTRUCTION

- Corps de pompe : En fonte G20 avec traitement anti-corrosion
- Lanterne: aluminium moulé sur pression UNI 5076
- Disque porte garniture: Technopolymère
- Diffuseurs: Technopolymère
- Turbine: in acier inox Aisi 304
- Abre de pompe: acier inox Aisi 420F
- Garniture mécanique: Carbone dur - Céramique

MOTOR

Le moteurs sont asynchrones à cage d'écureuil fermés à ventilation extérieure monofasiques,

- Pour le modèles monophasés son avec protection thermique et condensateur connecté en permanence
- Pour les modèles triphasés, la protection est à la charge de l'utilisateur. A recommandé l'équipement conformément à la réglementation
- A Classe d'isolation F - service S 1 - protection IP44
- Protection IP54 dans le terminal

MULTISTAGE CENTRIFUGAL ELECTRIC PUMPS

Extremely noiseless and reliable the multistage centrifugal electric pumps series MC have been designed to pump from basins or storage tanks, clean liquids, non-explosive or aggressive for the pump's materials, without abrasives and suspended solids.

- Liquid temperature not higher than 35 °C for domestic use (CEI EN 60335-2-41) or 90 °C for other use, while the ambient temperature must not be higher than 40 °C
- Flow rate up to ~ 5.5 m³/h
- Heads up to ~ 40 m

TECHNICAL FEATURES

- Pump body: G20 cast iron
- Motor bracket: in die casting aluminium UNI 5076
- Seal plate: Techno-polymer
- Diffusers: : Techno-polymer
- Impellers: stainless steel Aisi 304
- Pump shaft: stainless steel Aisi 420F
- Mechanical seal: carbon-ceramics

MOTOR

The control motors are asynchronous, squirrel cage-type, closed, with external ventilation

- Incorporated motor protection and capacitor always on, for single-phase models
- The motor protection for three-phase models must be installed by the customer. Equipment compliant with current standards should be used
- Class of insulation:F-service:S1-Degree of protection: IP 44
- Terminal board protection: IP 54

ELECTROBOMBAS CENTRÍFUGAS MULTIETAPA

Extremadamente silenciosas y fiables las electrobombas centrifugas multi-etapa de la serie MC han sido proyectadas para bombear desde depósitos o tanques de recogida, líquidos limpios sin partes abrasivas, sin cuerpos sólidos en suspensión, que no sean explosivos ni agresivos para los materiales de la bomba.

- Temperatura max. del líquido hasta 35 °C para uso doméstico (CEI EN 60335-2-41) o 90 °C para otros usos y temperatura ambiente hasta 40 °C.
- Caudal hasta 5.5 m³/h.
- Alturas hasta ~ 40 m.

CARACTERÍSTICAS DE CONSTRUCCIÓN

- Cuerpo de bomba: Fundición gris G20 con tratamiento contra-corrosión
- Soporte: fundición de aluminio UNI 5076
- Brida de cierre: De tecnopolimero
- Difusores: De tecnopolimero
- Rodetes: in de acero Inox AISI304
- Eje de la bomba: de acero Inox AISI420F
- Cierre mecánico: De cerámica y grafito

MOTOR

Los motores de accionamiento son asíncrono de jaula de ardilla cerrados, ventilados externamente

- Para los modelos monofásicos, protección térmica y condensador incorporado
- Para los modelos trifásicos de la protección se encarga el usuario y el equipo recomendado de acuerdo con las normas
- Aislamiento de Clase F - funcionamiento S1- protección IP44
- Protección IP54 para el terminal

50 Hz - min⁻¹ ~ 2900

TIPO TYPE		Potenza nominale Nominal power		Potenza assorbita Input power [W]		Condensatore Capacitor 450 V max	Corrente assorbita Input current [A]		Portata - Capacity							
Monofase Single-phase	Trifase Three-phase	kW	HP	a	b	[μF]	1~230V		Q [m ³ /h]	0	0,6	1,2	2,4	3	3,6	4,2
MC 2 M	-	0,37	0,5	500	-	12,5	2,2		Q [l/1']	0	10	20	40	50	60	70
MC 3 M	MC 3 T	0,44	0,6	600	580	14	3,5		Prevalenza (m C.A.) Total head (m W.C.)							
MC 4 M	MC 4 T	0,6	0,8	900	870	16	4		H [m]	21,1	20,1	18,7	14,8	12,0	9,2	6,0
										30,0	29,0	26,7	20,0	16,5	12,5	7,5
										40,0	39,0	36,5	28,5	24,0	18,5	12,0

a) ~ Monofase 230 V

b) ~ Trifase 230/400 V

60 Hz - min⁻¹ ~ 3400

TIPO TYPE		Potenza nominale Nominal power		Potenza assorbita Input power [W]		Condensatore Capacitor 450 V max	Corrente assorbita Input current [A]		Portata - Capacity							
		kW	HP			[μF]	1~115V	1~220V	Q [m ³ /h]	0	0,6	1,2	2,4	3	3,6	4,2
MC 3 M		0,45	0,6	830		14	7,7	3,6	Q [l/1']	0	10	20	40	50	60	70
									Prevalenza (m C.A.) Total head (m W.C.)							
									H [m]	30,4	28,8	26,9	22,0	19,0	15,6	11,9
										30,4	28,8	26,9	22,0	19,0	15,6	11,9

a) ~ Monofase 115/220 V

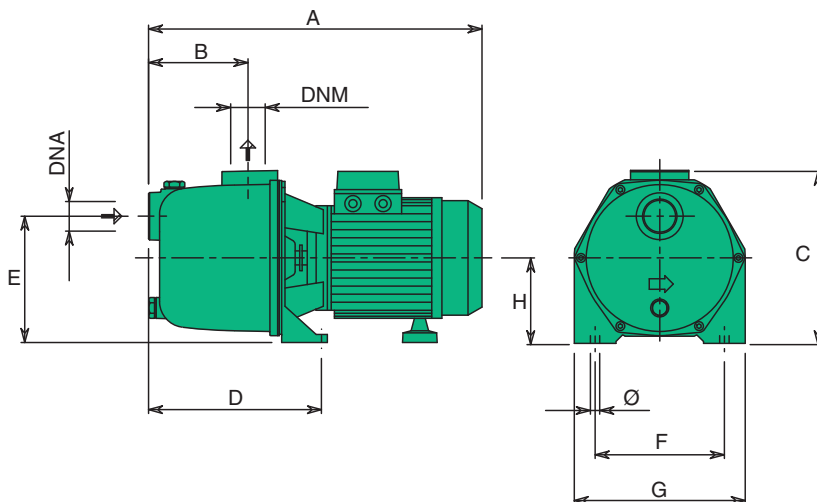

TIPO TYPE	DIMENSIONI [mm] DIMENSIONS [mm]											IMBALLO [mm] PACKING [mm]			PESO WEIGHT [kg]
	A	B	C	D	E	F	G	Ø	H	DNA	DNM	A	L	P	
MC 2	328	96	173	160	122	124	164	9	82	1"	1"	250	190	450	9,6
MC 3	328	96	173	160	122	124	164	9	82	1"	1"	250	190	450	9,8
MC 4	352	119	173	185	122	124	164	9	82	1"	1"	250	190	450	11,2

$\text{min}^{-1} \sim 2900$

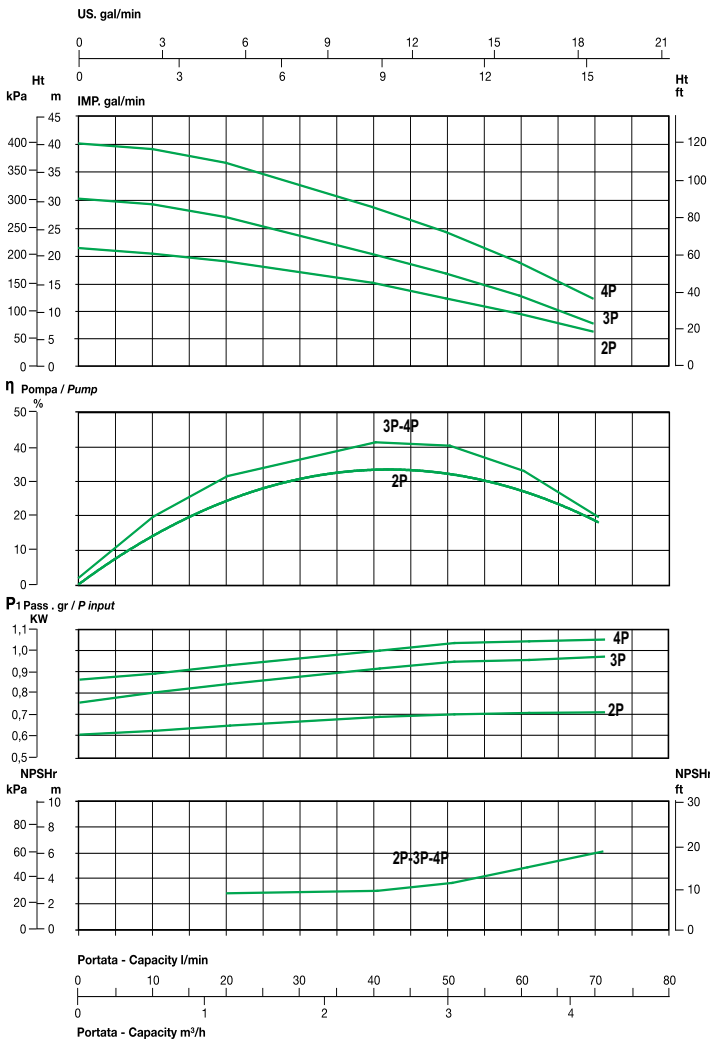

$\text{min}^{-1} \sim 3400$

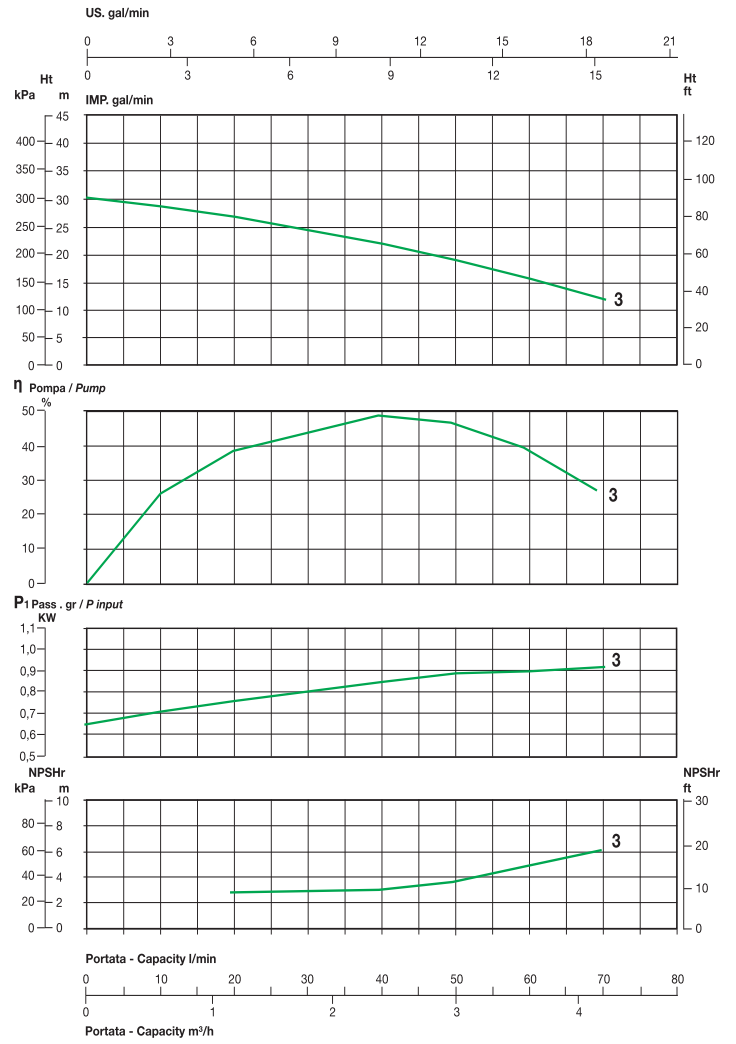

"MK"

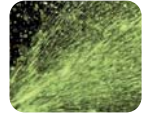

NOMENCLATURA PARTI DI RICAMBIO
SPARE PARTS LIST
NOMENCLATURE PIECES DE RECHANGE
NOMENCLATURA REPUESTOS

Giranti in acciaio
Stainless Steel impeller
Roues en acier
Impulsores de acero

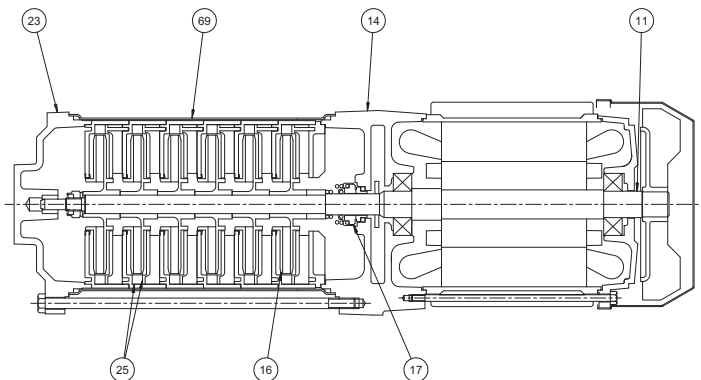

- 11** Albero con rotore – Pump shaft + rotor
Arbre + rotor – Eje rotor
- 14** Supporto mandata – Outlet bracket
Support envoyée – Soporte entrega
- 16** Girante – Impeller
Turbine – Impulsor
- 17** Tenuta meccanica – Mechanical seal
Garniture mécanique – Cierre mecánico
- 23** Corpo flangia aspirante – Suction flange body
Corp bride aspirant – Cuerpo brida entrega
- 25** Diffusore – Diffuser
Diffuseur – Difusor
- 69** Camicia – Cover
Chemise – Camisa

ELETTROPOMPE CENTRIFUGHE MULTISTADIO

Estremamente silenziose ed affidabili le elettropompe centrifughe multistadio della serie MK sono state progettate per pompare da serbatoi o vasche di raccolta, liquidi puliti, senza parti abrasive, senza corpi solidi in sospensione, non esplosivi o aggressivi per i materiali della pompa.

- Temperatura max. del liquido fino a 35 °C per uso domestico (CEI EN 60335-2-41) o 90 °C per altri usi e temperatura ambiente fino a 40 °C.
- Portate fino a 10 m³/h.
- Prevalenze fino a ~ 70 m.

CARATTERISTICHE COSTRUTTIVE

- Corpo pompa: ghisa G20 con trattamento anticorrosione
- Supporto mandata: ghisa G20 con trattamento anticorrosione
- Corpo pompa: acciaio inox Aisi 304
- Diffusori: Tecnopolimero
- Giranti: in acciaio inox Aisi 304
- Albero pompa: acciaio inox Aisi 304
- Tenuta meccanica: carbone-ceramica

MOTORE

I motori di comando sono del tipo asincrono a gabbia di scoiattolo chiusi, a ventilazione esterna

- Motoprotettore incorporato e condensatore permanentemente inserito per i tipi monofasi
- La protezione del motore nella versione trifase è a cura del cliente e si raccomandano apparecchiature in accordo con le norme vigenti
- Isolamento classe F – servizio S1- grado di protezione IP 44
- Protezione morsettiera IP 54

ÉLECTROPOMPES CENTRIFUGES MULTISTADIO

Extrêmement silencieuses et fiables les électropompes centrifuges multistadio de la série MK ont été conçues pour pomper de réservoirs ou de cuves, des liquides propres, sans parties abrasives, sans corps liquides en suspension, non explosifs ou agressifs pour les matériaux de la pompe.

- Température max. du liquide jusqu'à 35 °C pour utilisation domestique (CEI EN 60335-2-41) ou 90 °C pour d'autres utilisations et température ambiante jusqu'à 40 °C.
- Plage d'utilisation jusqu'à 10 m³/h.
- Hauteur manométrique jusqu'à ~ 70 m.

CARACTERISTIQUES DE CONSTRUCTION

- Corps de pompe : En fonte G20 avec traitement anti-corrosion
- Support refoulement: En fonte G20 avec traitement anti-corrosion
- Corps de pompe : acier inox Aisi 304
- Diffuseurs: Technopolymère
- Turbine: en acier inox Aisi 304
- Abre de pompe: acier inox Aisi 304
- Garniture mécanique: Carbone dur - Céramique

MOTOR

Le moteurs sont asynchrones à cage d'écuriel fermés à ventilation extérieure monofásicos,

- Pour le modèles monophasé son avec protection thermique et condensateur connecté en permanence
- Pour les modèles triphasés, la protection est à la charge de l'utilisateur. A recommandé l'équipement conformément à la réglementation
- A Classe d'isolation F - service S 1 – protection IP44
- Protection IP54 dans le terminal

MULTISTAGE CENTRIFUGAL ELECTRIC PUMPS

Extremely noiseless and reliable the multistage centrifugal electric pumps series MK have been designed to pump from basins or storage tanks, clean liquids, non-explosive or aggressive for the pump's materials, without abrasives and suspended solids.

- Liquid temperature not higher than 35 °C for domestic use (CEI EN 60335-2-41) or 90 °C for other use, while the ambient temperature must not be higher than 40 °C
- Flow rate up to ~ 10 m³/h
- Heads up to ~ 70 m

TECHNICAL FEATURES

- Pump body: stainless steel AISI 304
- Suction flange: cast iron G20 with anti-corrosive coating
- Outlet bracket: cast iron G20 with anti-corrosive coating
- Diffusers: Techno-polymer
- Impellers: stainless steel Aisi 304
- Pump shaft: stainless steel Aisi 304
- Mechanical seal: carbon-ceramics

MOTOR

The control motors are asynchronous, squirrel cage-type, closed, with external ventilation

- Incorporated motor protection and capacitor always on, for single-phase models
- The motor protection for three-phase models must be installed by the customer. Equipment compliant with current standards should be used
- Class of insulation:F-service:S1-Degree of protection: IP 44
- Terminal board protection: IP 54

ELECTROBOMBAS CENTRÍFUGAS MULTIETAPA

Extremadamente silenciosas y fiables las electrobombas centrifugas multi-etapa de la serie MK han sido proyectadas para bombear desde depósitos o tanques de recogida, líquidos limpios sin partes abrasivas, sin cuerpos sólidos en suspensión, que no sean explosivos ni agresivos para los materiales de la bomba.

- Temperatura max. del líquido hasta 35 °C para uso doméstico (CEI EN 60335-2-41) o 90 °C para otros usos y temperatura ambiente hasta 40 °C.
- Caudal hasta 10 m³/h.
- Alturas hasta ~ 70 m.

CARACTERÍSTICAS DE CONSTRUCCIÓN

- Cuerpo de bomba: Fundición gris G20 con tratamiento contra-corrosión
- Suporte de salida : Fundición gris G20 con tratamiento contra-corrosión
- Cuerpo de bomba: de acero Inox Aisi 304
- Difusores: De tecnopolímero
- Rodetes: de acero Inox Aisi 304
- Eje de la bomba: de acero Inox Aisi 304
- Cierre mecánico: De cerámica y grafito

MOTOR

Los motores de accionamiento son asíncrono de jaula de ardilla cerrados, ventilados externamente

- Para los modelos monofásicos, protección térmica y condensador incorporado
- Para los modelos trifásicos de la protección se encarga el usuario y el equipo recomendado de acuerdo con las normas
- Aislamiento de Clase F – funcionamiento S1- protección IP44
- Protección IP54 para el terminal

50 Hz - min⁻¹ ~ 2900

TIPO TYPE		Potenza nominale Nominal power		Potenza assorbita Input power [W]		Condensatore Capacitor 450 V max	Corrente assorbita Input current [A]			Portata - Capacity						
Monofase Single-phase	Trifase Three-phase	kW	HP	a	b		[μF]	1~230V	3~230V	3~400V	Q [m ³ /h]	Q [l/s]	Prevalenza (m C.A.) Total head (m W.C.)			
a	b									H [m]						
MK 80 M	MK 80 T	0,59	0,8	960	900	16	4,2	2,8	1,62	0	1,2	2,4	3,6	4,8	5,4	
MK 100 M	MK 100 T	0,75	1	1360	1110	20	6	3,8	2,2	0	20	40	60	80	90	
MK 120 M	MK 120 T	0,88	1,2	1540	1420	25	7,2	4,5	2,6	34,5	31,5	28,0	22,5	15,0	10	
										46,0	43,5	38,5	32,0	23,5	18,5	
										58,0	54,0	48,0	40,0	29,0	23,0	

a) ~ Monofase 230 V

b) ~ Trifase 230/400 V

TIPO TYPE		Potenza nominale Nominal power		Potenza assorbita Input power [W]		Condensatore Capacitor 450 V max	Corrente assorbita Input current [A]			Portata - Capacity						
Monofase Single-phase	Trifase Three-phase	kW	HP	a	b		[μF]	1~230V	3~230V	3~400V	Q [m ³ /h]	Q [l/s]	Prevalenza (m C.A.) Total head (m W.C.)			
a	b									H [m]						
MK 150 M	MK 150 T	1,1	1,5	1980	1880	31,5	9	6	3,5	0	1,2	3	4,8	7,2	8,4	9,6
MK 200 M	MK 200 T	1,5	2	2290	2180	40	11	7,2	4,2	0	20	50	80	120	140	160
MK 300 M	MK 300 T	2,2	3	2970	2810	55	12,5	9,4	5,4	49,5	48,0	44,0	39,2	28,0	20,8	11,2
										62,0	60,0	55,0	49,0	35,0	26	14
										74,0	70,0	65,0	58,5	42,0	31,5	16,0

a) ~ Monofase 230 V

b) ~ Trifase 230/400 V

60 Hz - min⁻¹ ~ 3400

TIPO TYPE		Potenza nominale Nominal power		Potenza assorbita Input power [W]		Condensatore Capacitor 450 V max	Corrente assorbita Input current [A]				Portata - Capacity						
Monofase Single-phase	Trifase Three-phase	kW	HP	a	b		[μF]	1~115V	1~220V	3~220V	3~380V	Q [m ³ /h]	Q [l/s]	Prevalenza (m C.A.) Total head (m W.C.)			
a	b										H [m]						
MK 80 M	MK 80 T	0,59	0,8	860	800	20	8,5	4,1	2,6	1,5	0	1,2	2,4	3,6	4,8	5,4	
MK 100 M	MK 100 T	0,75	1	1200	1000	25	10	5	3,5	1,75	0	20	40	60	80	90	
MK 120 M	MK 120 T	0,88	1,2	1550	1430	25	14,2	6,8	4,76	2,75	31,8	29,1	25	19,2	11,9	7,7	
											44,5	38,8	33,5	25,0	16,1	9,5	
											60,3	54,3	45,5	33,9	19,6	11,5	

a) ~ Monofase 115/220 V

b) ~ Trifase 220/380 V

TIPO TYPE		Potenza nominale Nominal power		Potenza assorbita Input power [W]		Condensatore Capacitor 450 V max	Corrente assorbita Input current [A]			Portata - Capacity							
Monofase Single-phase	Trifase Three-phase	kW	HP	a	b		[μF]	1~220V	3~220V	3~380V	Q [m ³ /h]	Q [l/s]	Prevalenza (m C.A.) Total head (m W.C.)				
a	b									H [m]							
MK 200 M	MK 200 T	1,47	2	2380	2390	40	12	7,8	4	0	1,2	3	4,8	7,2	8,4	9,6	
MK 300 M	MK 300 T	2,2	3	3180	3150	50	16,0	9,5	4,8	0	20	50	80	120	140	160	
											54,0	52,5	50,0	45,0	37	34	27,5
											70,0	69,0	64,0	59,0	48,0	42,0	33,0

a) ~ Monofase 220 V

b) ~ Trifase 220/380 V

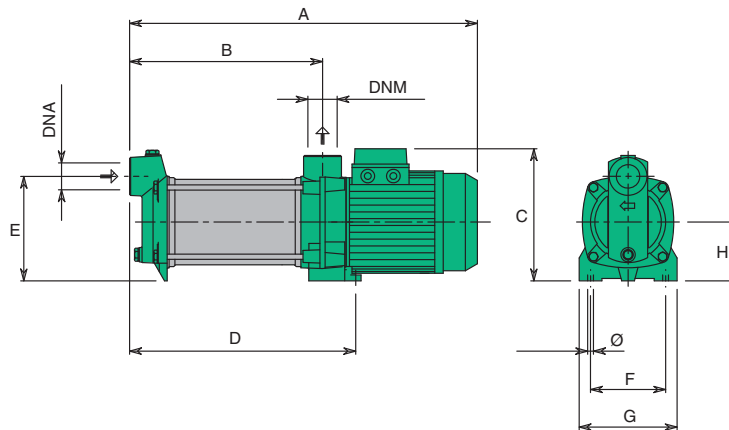

TIPO TYPE	DIMENSIONI [mm] DIMENSIONS [mm]									IMBALLO [mm] PACKING [mm]			PESO WEIGHT [kg]		
	A	B	C	D	E	F	G	∅	H	DNA	DNM	A		L	P
MK 80	400	185	182	225	130	110	145	9	77	1" G	1" G	230	200	450	14,4
MK 100	422	207	182	247	130	110	145	9	77	1" G	1" G	230	200	450	15,4
MK 120	444	230	182	269	130	110	145	9	77	1" G	1" G	230	200	450	16,4
MK 150	535	296	205	342	160	115	148	9	90	1" 1/4 G	1" 1/4 G	280	250	610	20
MK 200	535	296	205	342	160	115	148	9	90	1" 1/4 G	1" 1/4 G	280	250	610	23
MK 300	560	296	205	342	160	115	148	9	90	1" 1/4 G	1" 1/4 G	280	250	610	23,2

min⁻¹ ~ 2900

min⁻¹ ~ 3400

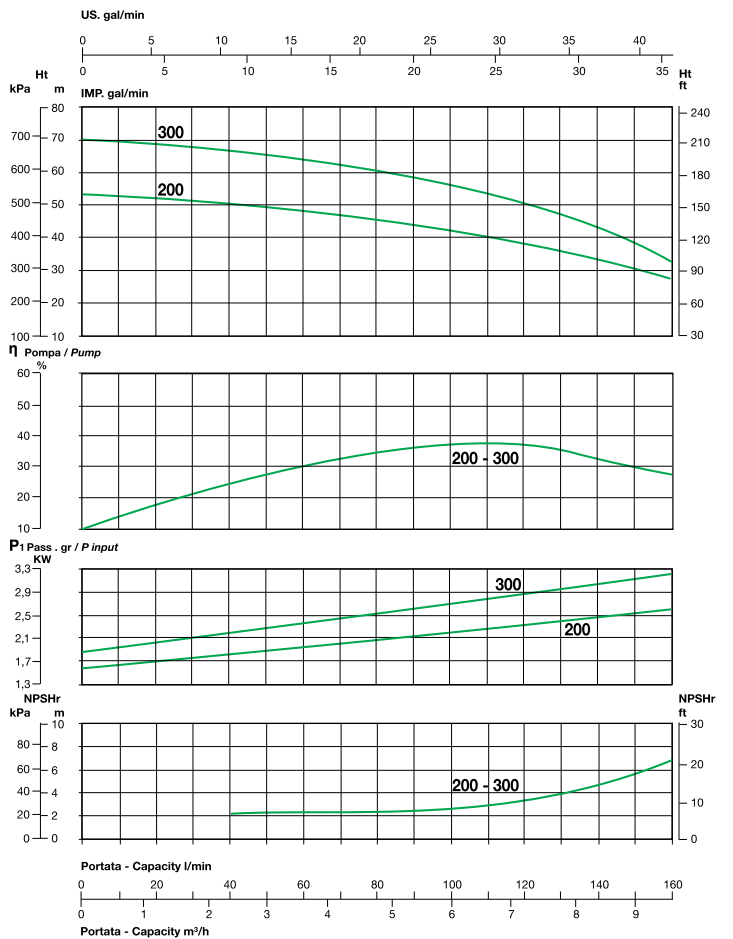
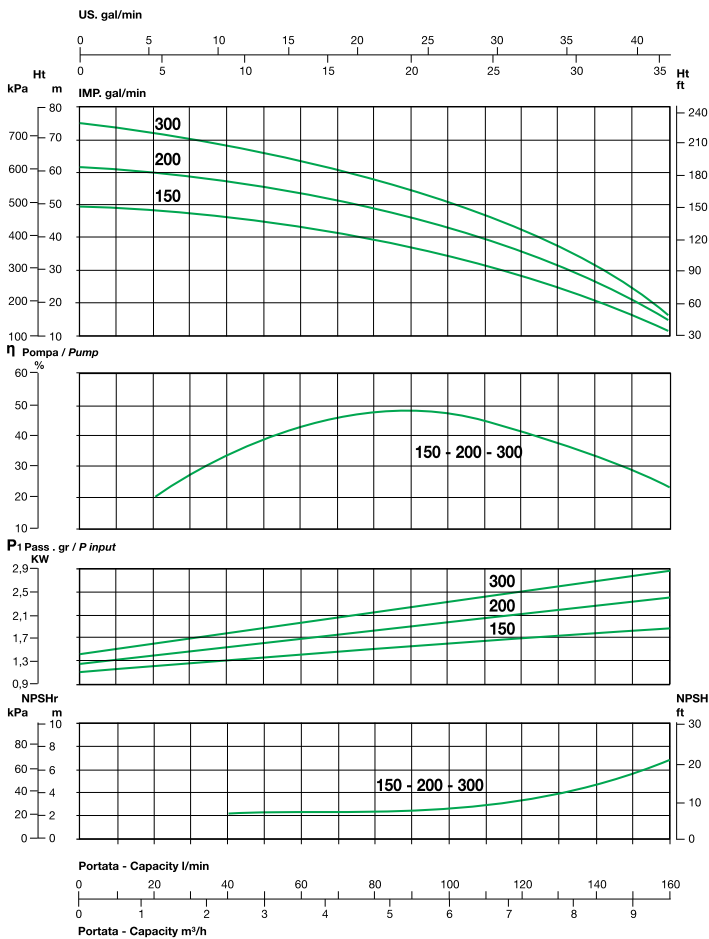
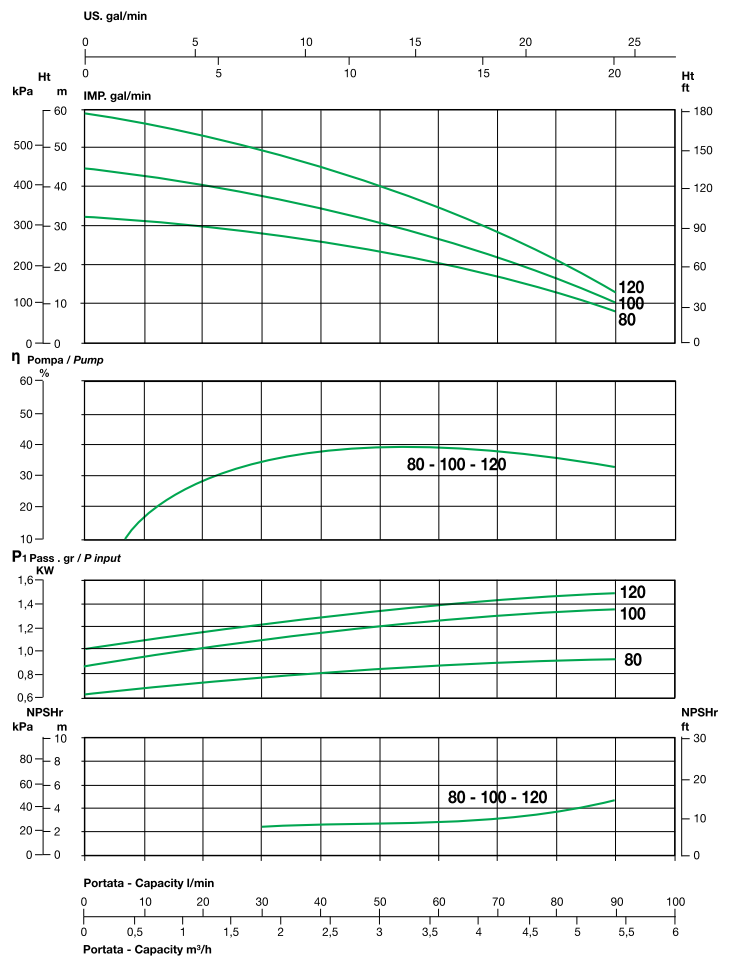
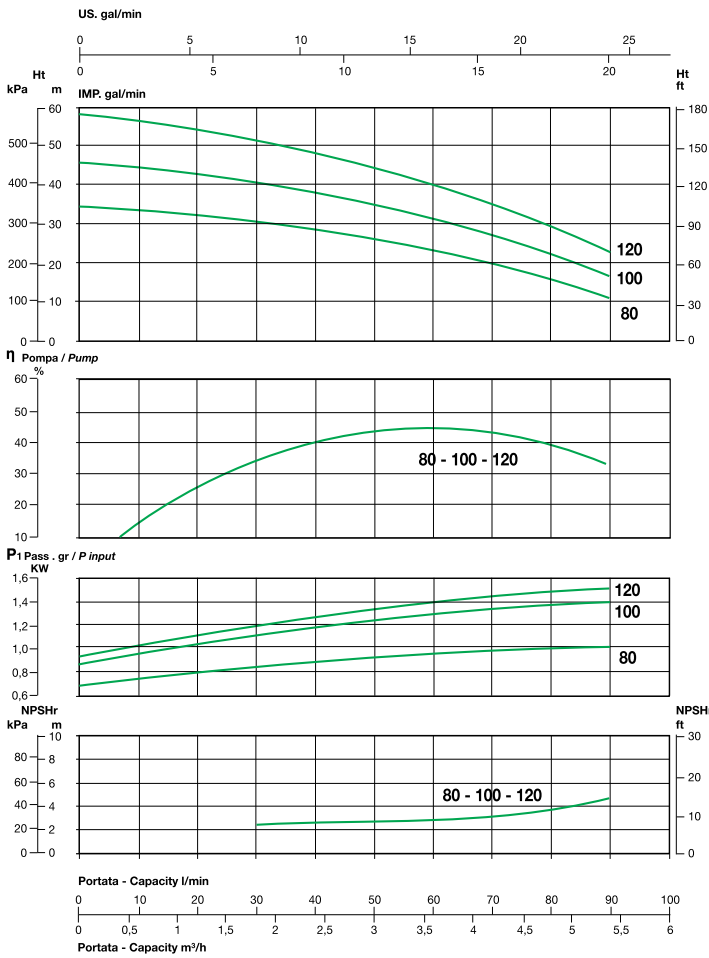

"KD"

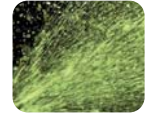

NOMENCLATURA PARTI DI RICAMBIO
SPARE PARTS LIST
NOMENCLATURE PIECES DE RECHANGE
NOMENCLATURA REPUESTOS

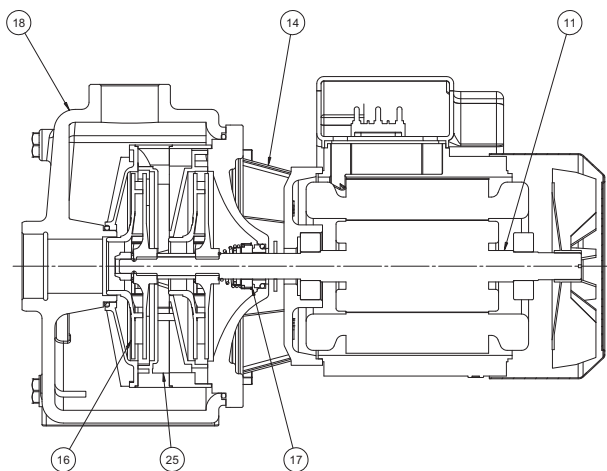

- 11** Albero con rotore – Pump shaft + rotor
Arbre + rotor – Eje rotor
- 14** Supporto mandata – Outlet bracket
Support envoyée – Soporte entrega
- 16** Girante – Impeller
Turbine – Impulsor
- 17** Tenuta meccanica – Mechanical seal
Garniture mécanique – Cierre mecánico
- 18** Corpo pompa – Pump body
Corp de pompe – Cuerpo bomba
- 25** Diffusore – Diffuser
Diffuseur – Difusor

ELETTROPOMPE CENTRIFUGHE BIGIRANTI

Elettropompe monoblocco a due giranti della serie KD sono state progettate per pompare da serbatoi o vasche di raccolta, liquidi puliti senza parti abrasive, senza corpi solidi in sospensione, non esplosivi o aggressivi per i materiali della pompa

- Temperatura max. del liquido fino a 35 °C per uso domestico (CEI EN 60335-2-41) o 60 °C per altri usi e temperatura ambiente fino a 40 °C.
- Portate fino a 12 m³/h.
- Prevalenze fino a ~45 m.

CARATTERISTICHE COSTRUTTIVE

- Corpo pompa: ghisa G20 con trattamento anticorrosione
- Supporto motore: ghisa G20 con trattamento anticorrosione
- Diffusori: Tecnopolimero
- Giranti: Tecnopolimero
- Albero pompa: acciaio inox Aisi 304
- Tenuta meccanica: carbone-ceramica

MOTORE

I motori di comando sono del tipo asincrono a gabbia di scoiattolo chiusi, a ventilazione esterna

- Motoprotettore incorporato e condensatore permanentemente inserito per i tipi monofasi
- La protezione del motore nella versione trifase è a cura del cliente e si raccomandano apparecchiature in accordo con le norme vigenti
- Isolamento classe F –servizio S1- grado di protezione IP 44
- Protezione morsettiera IP 54

ÉLECTROPOMPES CENTRIFUGES À DEUX ROUES

Électropompes monobloc à deux roues de la série KD ont été conçues pour pomper de réservoirs ou de cuves, des liquides propres sans parties abrasives, sans corps liquides en suspension, non explosifs ou agressifs pour les matériaux de la pompe

- Température max. du liquide jusqu'à 35 °C pour utilisation domestique (CEI EN 60335-2-41) ou 60 °C pour d'autres utilisations et température ambiante jusqu'à 40 °C.
- Plage d'utilisation jusqu'à 12 m³/h.
- Hauteur manométrique jusqu'à ~45 m.

CARACTERISTIQUES DE CONSTRUCTION

- Corps de pompe : En fonte G20 avec traitement anti-corrosion
- Lanterne: En fonte G20 avec traitement anti-corrosion
- Diffuseur: Technopolymère
- Turbine: Technopolymère
- Abre de pompe: acier inox Aisi 304
- Garniture mécanique: Carbone dur - Céramique

MOTOR

Le moteurs sont asynchrones à cage d'écuriel fermés à ventilation extérieure monofásicos,

- Pour les modèles monophasés son avec protection thermique et condensateur connecté en permanence
- Pour les modèles triphasés, la protection est à la charge de l'utilisateur. A recommandé l'équipement conformément à la réglementation
- A Classe d'isolation F - service S 1 – protection IP44
- Protection IP54 dans le terminal

DOUBLE IMPELLER CENTRIFUGAL ELECTRIC PUMPS

The close-coupled double impeller electric pumps series KD have been designed to pump from basins or storage tanks, clean liquids, without abrasives and suspended solids, non-explosive or aggressive for the pump's materials

- Liquid temperature not higher than 35 °C for domestic use (CEI EN 60335-2-41) or 60 °C for other use, while the ambient temperature must not be higher than 40 °C
- Flow rate up to ~ 12 m³/h
- Heads up to ~ 45 m

TECHNICAL FEATURES

- Pump body: cast iron G20 with anti-corrosive coating
- Motor bracket: cast iron G20 with anti-corrosive coating
- Diffusers: Techno-polymer
- Impellers: Techno-polymer
- Pump shaft: stainless steel Aisi 304
- Mechanical seal: carbon-ceramics

MOTOR

The control motors are asynchronous, squirrel cage-type, closed, with external ventilation

- Incorporated motor protection and capacitor always on, for single-phase models
- The motor protection for three-phase models must be installed by the customer. Equipment compliant with current standards should be used
- Class of insulation: F-service: S1- Degree of protection: IP 44
- Terminal board protection: IP 54

ELECTROBOMBAS CENTRÍFUGAS DOBLE IMPULSOR

Las electrobombas monobloque con dos impulsores de la serie KD han sido proyectadas para bombear desde depósitos o tanques de recogida, líquidos limpios sin partes abrasivas, sin cuerpos sólidos en suspensión, que no sean explosivos ni agresivos para los materiales de la bomba.

- Temperatura max. del líquido hasta 35 °C para uso doméstico (CEI EN 60335-2-41) o 60 °C para otros usos y temperatura ambiente hasta 40 °C.
- Caudal hasta 12 m³/h.
- Alturas hasta ~45 m.

CARACTERÍSTICAS DE CONSTRUCCIÓN

- Cuerpo de bomba: Fundición gris G20 con tratamiento contra-corrosión
- Soporte: Fundición gris G20 con tratamiento contra-corrosión
- Difusores: De tecnopolímero
- Rodetes: De tecnopolímero
- Eje de la bomba: de acero Inox AISI304
- Cierre mecánico: De cerámica y grafito

MOTOR

Los motores de accionamiento son asíncrono de jaula de ardilla cerrados, ventilados externamente

- Para los modelos monofásicos, protección térmica y condensador incorporado
- Para los modelos trifásicos de la protección se encarga el usuario y el equipo recomendado de acuerdo con las normas
- Aislamiento de Clase F – funcionamiento S1- protección IP44
- Protección IP54 para el terminal

50 Hz - min⁻¹ ~ 2900

TIPO TYPE		Potenza nominale Nominal power		Potenza assorbita Input power [W]		Condensatore Capacitor 450 V max	Corrente assorbita Input current [A]			Portata - Capacity														
Monofase Single-phase	Trifase Three-phase	kW	HP	a	b	[μF]	1~230V	3~230V	3~400V	Q [m ³ /h]	0	1,2	2,4	3	3,6	4,8	5,4	6	6,6	7,2	8,4	9,6	10,8	12
										Q [l/s]	0	20	40	50	60	80	90	100	110	120	140	160	180	200
									Prevalenza (m C.A.) Total head (m W.C.)															
a	b									H [m]	44,6	44,4	44,0	43,5	43,0	41,6	40,8	39,7	37,9	35,7	30,5	24,2		
KD 150 M	KD 150 T	1,1	1,5	1780	1860	40	8,1	6,9	3,9		46,5	46,2	46,1	45,8	45,6	44,3	43,8	43,2	42,1	40,8	37	32,1		
KD 200 M	KD 200 T	1,47	2	2140	2160	45	9,6	7,3	4,2		48,2	48,0	47,7	47,5	47,2	46,5	46,1	45,6	45,2	44,3	42,0	38,4	34,0	27,9
KD 300 M	KD 300 T	2,2	3	-	3280	-	-	9,3	5,6															

a) ~ Monofase 230 V

b) ~ Trifase 230/400 V

60 Hz - min⁻¹ ~ 3400

TIPO TYPE		Potenza nominale Nominal power		Potenza assorbita Input power [W]		Condensatore Capacitor 450 V max	Corrente assorbita Input current [A]			Portata - Capacity														
Monofase Single-phase	Trifase Three-phase	kW	HP	a	b	[μF]	1~220V	3~220V	3~380V	Q [m ³ /h]	0	1,2	2,4	3	3,6	4,8	5,4	6	6,6	7,2	8,4	9,6	10,8	12
										Q [l/s]	0	20	40	50	60	80	90	100	110	120	140	160	180	200
									Prevalenza (m C.A.) Total head (m W.C.)															
a	b									H [m]	48	47	46,2	45,6	44,9	42,5	41,1	39,3	37,8	35,4	29,8	21,5		
KD 150 M	KD 150 T	1,1	1,5	2100	1390	40	9,7	5,9	3,2		48,6	48,0	47,1	46,8	46,2	45,3	44	43,2	41,2	38,9	34,9	28,5		
KD 200 M	KD 200 T	1,47	2	2440	1690	45	11,2	7,1	3,9		51,1	50,8	49,9	49,3	48,7	47,5	46,6	45,9	45,2	44,3	42,0	38,4	33,0	24,9
-	KD 300 T	2,2	3	-	2450	-	-	9,3	5,6															

a) ~ Monofase 220 V

b) ~ Trifase 220/380 V

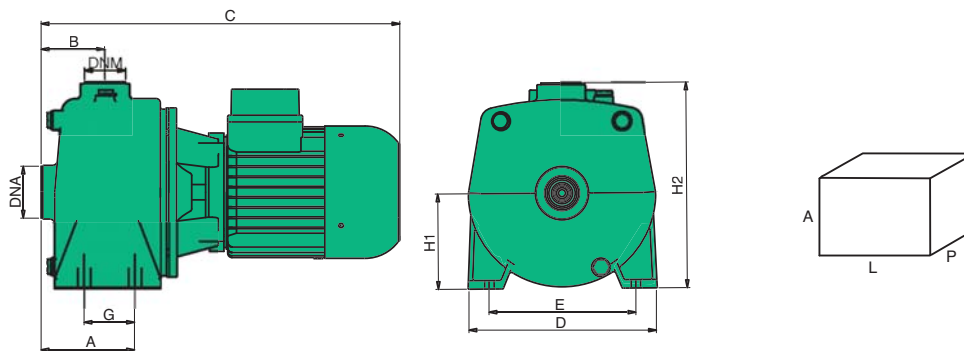

TIPO TYPE	DIMENSIONI [mm] DIMENSIONS [mm]										IMBALLO [mm] PACKING [mm]			PESO WEIGHT [kg]
	A	B	C	D	E	G	H1	H2	DNA	DNM	A	L	P	
KD 150	125	74	415	226	174	104	120	248	1"1/2	1"1/4	250	450	190	14.3
KD 200	125	74	415	226	174	104	120	248	1"1/2	1"1/4	350	430	240	27.3
KD 300	125	74	415	226	174	104	120	248	1"1/2	1"1/4	350	430	240	28.9

$\text{min}^{-1} \sim 2900$

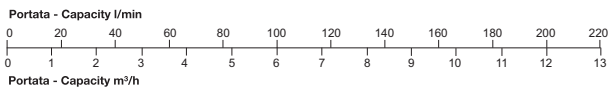
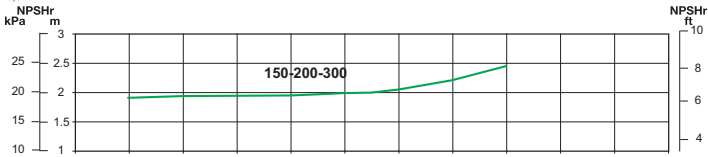
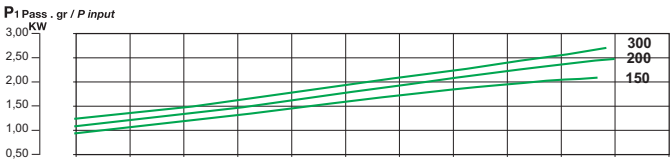
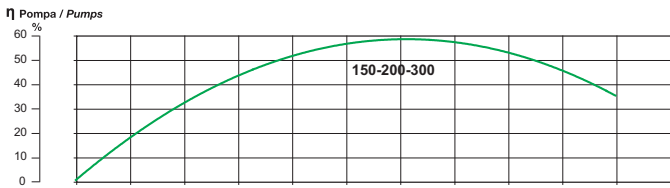
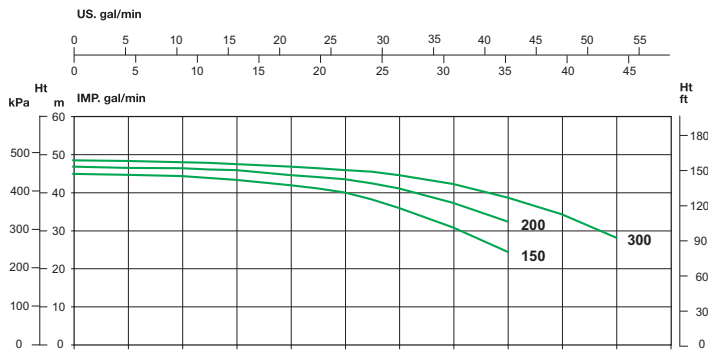

$\text{min}^{-1} \sim 3400$

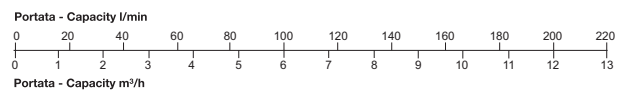
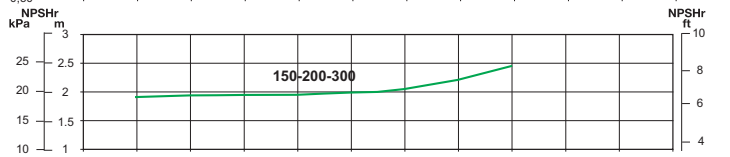
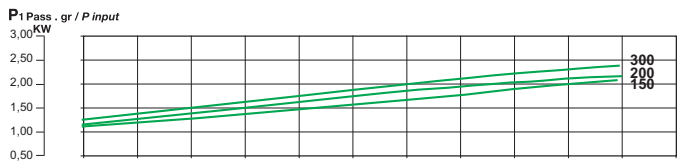
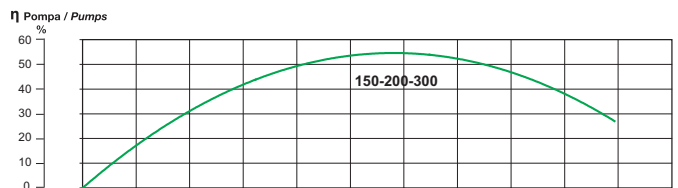
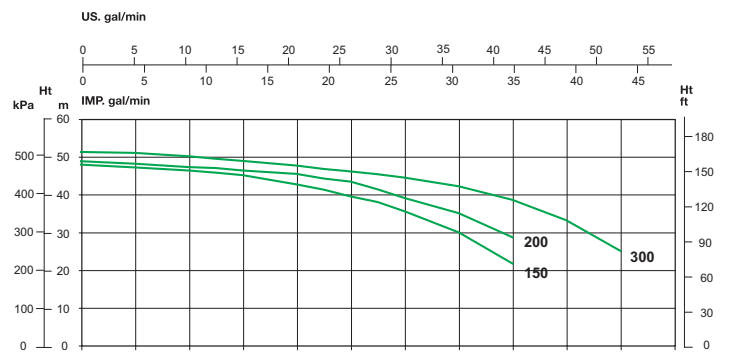

"BK"



NOMENCLATURA PARTI DI RICAMBIO
SPARE PARTS LIST
NOMENCLATURE PIECES DE RECHANGE
NOMENCLATURA REPUESTOS

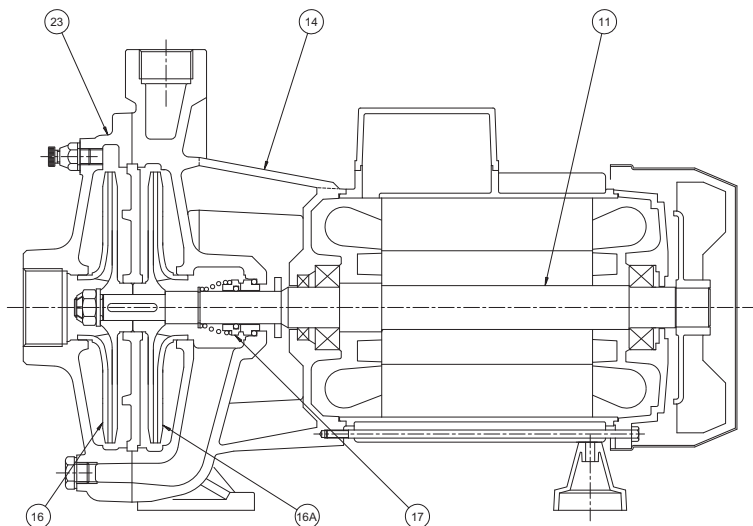

- 11** Albero con rotore – Pump shaft + rotor
Arbre + rotor – Eje rotor
- 14** Supporto mandata – Outlet bracket
Support envoyée – Soporte entrega
- 16** Girante – Impeller
Turbine – Impulsor
- 16A** Girante posteriore – Impeller back
Turbine postérieur – Impulsor espalda
- 17** Tenuta meccanica – Mechanical seal
Garniture mécanique – Cierre mecánico
- 23** Corpo flangia aspirante – Suction flange body
Corp bride aspirant – Cuerpo brida entrega

ELETTROPOMPE CENTRIFUGHE BIGIRANTI

Elettropompe monoblocco a due giranti contrapposte (con spinta assiale equilibrata) della serie BK sono state progettate per pompare da serbatoi o vasche di raccolta, liquidi puliti senza parti abrasive, senza corpi solidi in sospensione, non esplosivi o aggressivi per i materiali della pompa

- Temperatura max. del liquido fino a 35 °C per uso domestico (CEI EN 60335-2-41) o 90 °C per altri usi e temperatura ambiente fino a 40 °C.
- Portate fino a ~ 30 m³/h.
- Prevalenze fino a ~110 m.

CARATTERISTICHE COSTRUTTIVE

- Corpo pompa: ghisa G20 con trattamento anticorrosione
- Flangia aspirazione: ghisa G20 con trattamento anticorrosione
- Flangia intermedia: ghisa G20 con trattamento anticorrosione
- Giranti: ottone stampato UNI-EN 12165 serie BK
- Giranti: Ghisa G20 per serie BK 753/1503
- Albero pompa: acciaio inox Aisi 304 (Aisi 420 F per BK 100)
- Tenuta meccanica: carbone-ceramica

MOTORE

I motori di comando sono del tipo asincrono a gabbia di scoiattolo chiusi, a ventilazione esterna

- Motoprotettore incorporato e condensatore permanentemente inserito per i tipi monofasi
- La protezione del motore nella versione trifase è a cura del cliente e si raccomandano apparecchiature in accordo con le norme vigenti
- Isolamento classe F - servizio S1- grado di protezione IP 44
- Protezione morsettiera IP 54

ÉLECTROPOMPES CENTRIFUGES À DEUX ROUES

Les électropompes monobloc à deux roues opposées (avec poussée axiale équilibrée) de la série BK ont été conçues pour pomper de réservoirs ou de cuves, des liquides propres sans parties abrasives, sans corps liquides en suspension, non explosifs ou agressifs pour les matériaux de la pompe

- Température max. du liquide jusqu'à 35 °C pour utilisation domestique (CEI EN 60335-2-41) ou 90 °C pour d'autres utilisations et température ambiante jusqu'à 40 °C.
- Plage d'utilisation jusqu'à ~ 30 m³/h.
- Hauteur manométrique jusqu'à ~110 m.

CARACTERISTIQUES DE CONSTRUCTION

- Corps de pompe : En fonte G20 avec traitement anti-corrosion
- Bride de aspiration : En fonte G20 avec traitement anti-corrosion
- Bride Intermediaire: En fonte G20 avec traitement anti-corrosion
- Turbine: laiton étampé UNI-EN 12165
- Turbine: En Fonte G20 pour série BK 753/1503
- Abre de pompe: acier inox Aisi 304 (Inox 420 F pour BK 100)
- Garniture mécanique: Carbone dur - Céramique

MOTOR

Le moteurs sont asynchrones à cage d'écuriel fermés à ventilation extérieure monofasiques,

- Pour le modèles monophasé son avec protection thermique et condensateur connecté en permanence
- Pour les modèles triphasés, la protection est à la charge de l'utilisateur. A recommandé l'équipement conformément à la réglementation
- A Classe d'isolation F - service S 1 – protection IP44
- Protection IP54 dans le terminal

TWIN IMPELLER CENTRIFUGAL ELECTRIC PUMPS

The close-coupled electric pumps with back to back impellers (with an axial balanced thrust) series BK have been designed to pump from basins or storage tanks, clean liquids, without abrasives and suspended solids, non-explosive or aggressive for the pump's materials

- Liquid temperature not higher than 35 °C for domestic use (CEI EN 60335-2-41) or 90 °C for other use, while the ambient temperature must not be higher than 40 °C
- Flow rate up to ~ 30 m³/h
- Heads up to ~ 110 m

TECHNICAL FEATURES

- Pump body: cast iron G20 with anti-corrosive coating
- Suction flange: cast iron G20 with anti-corrosive coating
- Middle flange: cast iron G20 with anti-corrosive coating
- Impellers: stamped brass UNI- EN 12165 for the BK series
- Impellers: G20 cast iron for the BK 753/1503
- Pump shaft: stainless steel Aisi 304 (Aisi 420 F for BK 100)
- Mechanical seal: carbon-ceramics

MOTOR

The control motors are asynchronous, squirrel cage-type, closed, with external ventilation

- Incorporated motor protection and capacitor always on, for single-phase models
- The motor protection for three-phase models must be installed by the customer. Equipment compliant with current standards should be used
- Class of insulation:F-service:S1-Degree of protection: IP 44
- Terminal board protection: IP 54

ELECTROBOMBAS CENTRÍFUGAS DOBLE IMPULSOR

Las electrobombas monobloque con dos impulsores contrapuestos (con esfuerzo axial equilibrado) de la serie BK han sido proyectadas para bombear, desde depósitos o tanques de recogida, líquidos limpios sin partes abrasivas, sin cuerpos sólidos en suspensión, que no sean explosivos ni agresivos para los materiales de la bomba.

- Temperatura max. del líquido hasta 35 °C para uso doméstico (CEI EN 60335-2-41) o 90 °C para otros usos y temperatura ambiente hasta 40 °C.
- Caudal hasta ~ 30 m³/h.
- Alturas hasta ~110 m.

CARACTERÍSTICAS DE CONSTRUCCIÓN

- Cuerpo de bomba: Fundición gris G20 con tratamiento contra-corrosión
- Tapa delantera: Fundición gris G20 con tratamiento contra-corrosión
- Tapa intermedias: Fundición gris G20 con tratamiento contra-corrosión
- Rodetes: De latón UNI-EN 12165
- Rodetes: Fundición gris G20 para las BK 753/1503
- Eje de la bomba: de acero Inox AISI304 (Inox 420 F para las BK 100)
- Cierre mecánico: De cerámica y grafito

MOTOR

Los motores de accionamiento son asíncrono de jaula de ardilla cerrados, ventilados externamente

- Para los modelos monofásicos, protección térmica y condensador incorporado
- Para los modelos trifásicos de la protección se encarga el usuario. y el equipo recomendado de acuerdo con las normas
- Aislamiento de Clase F – funcionamiento S1- protección IP44
- Protección IP54 para el terminal

50 Hz - min⁻¹ ~ 2900

TIPO TYPE		Potenza nominale Nominal power		Potenza assorbita Input power [W]		Condensatore Capacitor 450 V max	Corrente assorbita Input current [A]			Portata - Capacity								
Monofase Single-phase	Trifase Three-phase	kW	HP	a	b	[µF]	1~230V	3~230V	3~400V	Q [m ³ /h]	Q [l/s]	Prevalenza (m C.A.) Total head (m W.C.)						
a	b									H [m]								
BK 100 M	BK 100 T	0,75	1	1250	1140	20	5,5	4	2,3	43,5	42,0	39,5	35,0	29,0	20,5	13		

a) ~ Monofase 230 V

b) ~ Trifase 230/400 V

TIPO TYPE		Potenza nominale Nominal power		Potenza assorbita Input power [W]		Condensatore Capacitor 450 V max	Corrente assorbita Input current [A]			Portata - Capacity								
Monofase Single-phase	Trifase Three-phase	kW	HP	a	b	[µF]	1~230V	3~230V	3~400V	Q [m ³ /h]	Q [l/s]	Prevalenza (m C.A.) Total head (m W.C.)						
a	b									H [m]								
BK 150 M	BK 150 T	1,1	1,5	2200	2140	31,5	9,5	6,2	3,6	48,0	47,0	41,5	33,0	20,0	16			
BK 200 M	BK 200 T	1,5	2	2490	2450	40	11,5	7,6	4,3	54,5	53,5	48,5	38,5	25,0	20			
BK 300 M	BK 300 T	2,2	3	2900	3060	60	13,5	9	5,2	60,0	60,0	54,5	46,0	33,0	29,5			

a) ~ Monofase 230 V

b) ~ Trifase 230/400 V

TIPO TYPE		Potenza nominale Nominal power		Potenza assorbita Input power [W]		Condensatore Capacitor 450 V max	Corrente assorbita Input current [A]			Portata - Capacity								
Monofase Single-phase	Trifase Three-phase	kW	HP	a	b	[µF]	1~230V	3~230V	3~400V	Q [m ³ /h]	Q [l/s]	Prevalenza (m C.A.) Total head (m W.C.)						
a	b									H [m]								
BK 400 M	BK 400 T	3	4	4470	4530	70	18	15,7	9	66,0	65,0	61,5	58,0	50,5	42	37		
-	BK 550 T	4	5,5	-	6110	-	-	18,2	10,5	79,5	79,0	78,0	72,0	65,0	56	50		
-	BK 750 T	5,5	7,5	-	7230	-	-	20	12	89,0	87,0	83,0	78,0	71,5	62	58	45	
-	BK 1000 T	7,5	10	-	9730	-	-	27,7	16	110,0	107,0	102,0	96,0	90,0	83	80	66	

a) ~ Monofase 230 V

b) ~ Trifase 230/400 V

TIPO TYPE	Potenza nominale Nominal power		Potenza assorbita Input power [W]	Corrente assorbita Input current [A]		Portata - Capacity									
Trifase Three-phase	kW	HP		3~230V	3~400V	Q [m ³ /h]	Q [l/s]	Prevalenza (m C.A.) Total head (m W.C.)							
						H [m]									
BK 753 T	5,5	7,5	7080	19	11	70,0	69,0	61,0	51,0	34,0	20				
BK 1003 T	7,5	10	10000	28,4	16,4	85,0	86,5	81,0	70,0	52,0	40	25			
BK 1253 T	9,2	12,5	11380	32	19,5	93,0	92,5	88,0	79,0	63,0	51	39			
BK 1503 T	11	15	13130	36,4	23	105,0	106,0	100,0	90,0	73,0	61	50			

b) ~ Trifase 230/400 V

TIPO TYPE	DIMENSIONI [mm] DIMENSIONS [mm]								IMBALLO [mm] PACKING [mm]			PESO WEIGHT [kg]		
	A	B	C	D	F	G	Ø	H	DNA	DNM	A		L	P
BK 100	325	71	227	100	140	180	9	97	1" G	1" G	320	220	360	16,2
BK 150	395	88	284	131	185	235	9,5	125	1" 1/2G	1" G	325	265	430	27,8
BK 200	395	88	284	131	185	235	9,5	125	1" 1/2G	1" G	325	265	430	28,6
BK 300	440	88	284	131	185	235	9,5	125	1" 1/2G	1" G	380	280	520	34,2
BK 300 T	395	88	284	131	185	235	9,5	125	1" 1/2G	1" G	380	280	520	29,8
BK 400 M	490	103,5	312,5	160	220	270	9,5	140	2" G	1" 1/4 G	380	290	520	48,8
BK 400	490	103,5	312,5	160	220	270	9,5	140	2" G	1" 1/4 G	380	290	520	46
BK 550	490	103,5	312,5	160	220	270	9,5	140	2" G	1" 1/4 G	380	290	520	49,2
BK 750	496	103,5	357,5	160	240	300	13	160	2" G	1" 1/4 G	550	350	580	65
BK 1000	496	103,5	357,5	160	240	300	13	160	2" G	1" 1/4 G	550	350	580	86
BK 753	540	117,5	345	179,5	230	295	13	160	2" G	1" 1/2 G	550	350	580	65
BK 1003	608	117,5	345	179,5	230	295	13	160	2" G	1" 1/2 G	560	350	700	81
BK 1253	608	117,5	345	179,5	230	295	13	160	2" G	1" 1/2 G	560	350	700	87
BK 1503	646	117,5	345	179,5	230	295	13	160	2" G	1" 1/2 G	560	350	700	95

60 Hz - min⁻¹ ~ 3400

TIPO TYPE		Potenza nominale Nominal power		Potenza assorbita Input power [W]		Condensatore Capacitor 450 V max	Corrente assorbita Input current [A]				Portata - Capacity													
Monofase Single-phase	Trifase Three-phase	kW	HP	a	b	[μF]	1~115V	1~220V	3~220V	3~380V	Prevalenza (m C.A.) Total head (m W.C.)													
a	b										H [m]													
BK 100 M	BK 100 T	0,75	1	1290	1200	25	11,5	5,8	4,3	2,4	0	0,9	1,8	2,7	3,6	4,5	5,1	0	15	30	45	60	75	85

a) ~ Monofase 115/220 V

b) ~ Trifase 220/380 V

TIPO TYPE		Potenza nominale Nominal power		Potenza assorbita Input power [W]		Condensatore Capacitor 450 V max	Corrente assorbita Input current [A]			Portata - Capacity																		
Monofase Single-phase	Trifase Three-phase	kW	HP	a	b	[μF]	1~220V	3~220V	3~380V	Prevalenza (m C.A.) Total head (m W.C.)																		
a	b									H [m]																		
BK 150 M	BK 150 T	1,1	1,5	2300	2230	31,5	10	5,9	3,2	0	1,2	3,6	6	8,4	9	0	20	60	100	140	150	51,0	49,0	43,0	35,0	20,0	17	
BK 200 M	BK 200 T	1,5	2	2750	2730	40	12,5	9	4,6	51,0	49,0	43,0	35,0	20,0	17	56,5	55,5	50,8	41,6	28,2	22	64,5	63,6	59,2	50,0	35,0	30	
BK 300 M	BK 300 T	2,2	3	3140	3200	60	15	11,2	5,6	64,5	63,6	59,2	50,0	35,0	30													

a) ~ Monofase 220 V

b) ~ Trifase 220/380 V

TIPO TYPE		Potenza nominale Nominal power		Potenza assorbita Input power [W]		Condensatore Capacitor 450 V max	Corrente assorbita Input current [A]			Portata - Capacity																		
Monofase Single-phase	Trifase Three-phase	kW	HP	a	b	[μF]	1~220V	3~220V	3~380V	Prevalenza (m C.A.) Total head (m W.C.)																		
a	b									H [m]																		
BK 400 M	BK 400 T	3	4	5120	5230	70	19,5	13,8	8	69,0	68,0	65,2	60,0	55,0	46,4	40												
-	BK 550 T	4	5,5	-	5620	-	-	18,2	10,5	80,0	79,0	76,5	71,5	64,0	55	49,2												
-	BK 750 T	5,5	7,5	-	6810	-	-	23,4	13,5	96,5	93,3	88,3	82,0	75,0	66,3	60	45											
-	BK 1000 T	7,5	10	-	9720	-	-	28,5	16,5	109,0	104,0	98,0	93,0	87,0	79,6	73,3	60											

a) ~ Monofase 220 V

b) ~ Trifase 220/380 V

TIPO TYPE	Potenza nominale Nominal power		Potenza assorbita Input power [W]	Corrente assorbita Input current [A]		Portata - Capacity																					
Trifase Three-phase	kW	HP		3~220V	3~380V	Prevalenza (m C.A.) Total head (m W.C.)																					
						H [m]																					
BK 753 T	5,5	7,5	7170	21	13,5	0	6	12	18	24	27	30	0	100	200	300	400	450	500	72,0	70,0	65,2	57,3	41,0	32,0		
BK 1003 T	7,5	10	9560	29	16,5	86,0	85,6	81,0	72,4	56,8	45,0	27,6	93,0	93,2	89,8	80,0	63,8	50,0	39,7								
BK 1253 T	9,2	12,5	11000	34	19,5	105,0	104,7	100,0	91,0	76,7	70,0	50,0															
BK 1503 T	11	15	12810	38	22																						

a) ~ Monofase 220 V

b) ~ Trifase 220/380 V

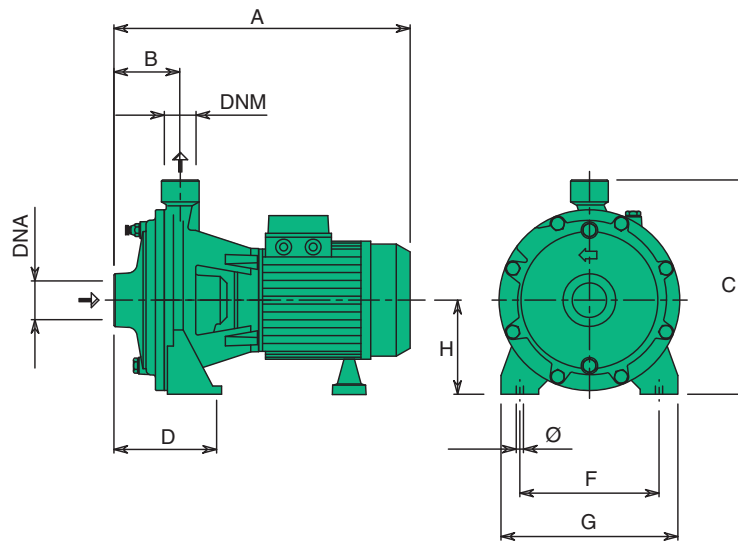

min⁻¹ ~ 2900

min⁻¹ ~ 3400

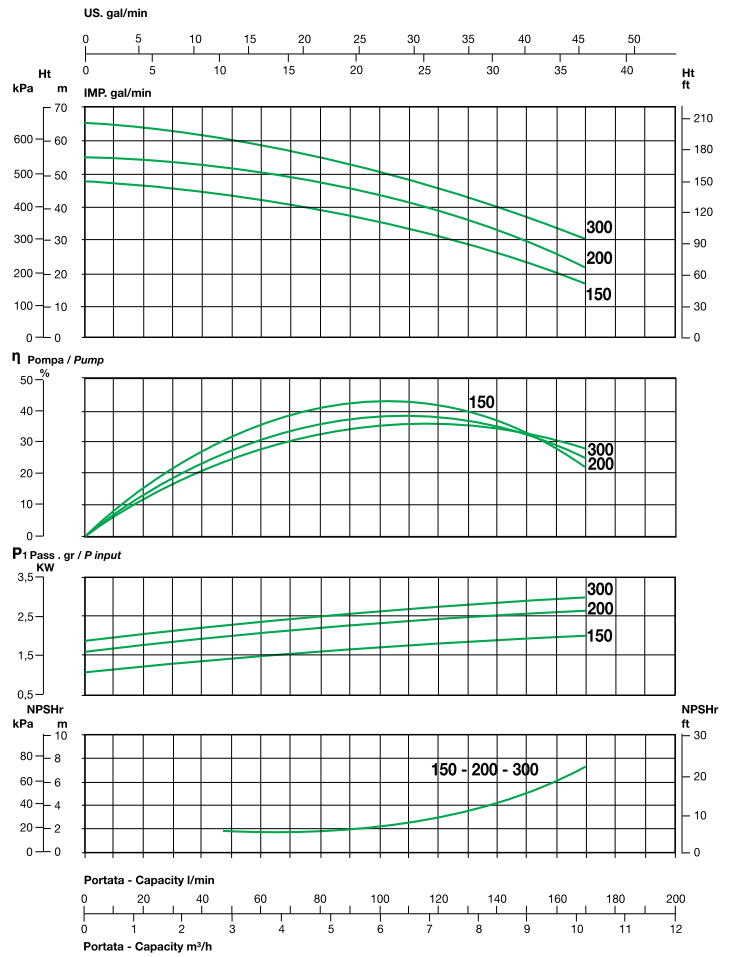
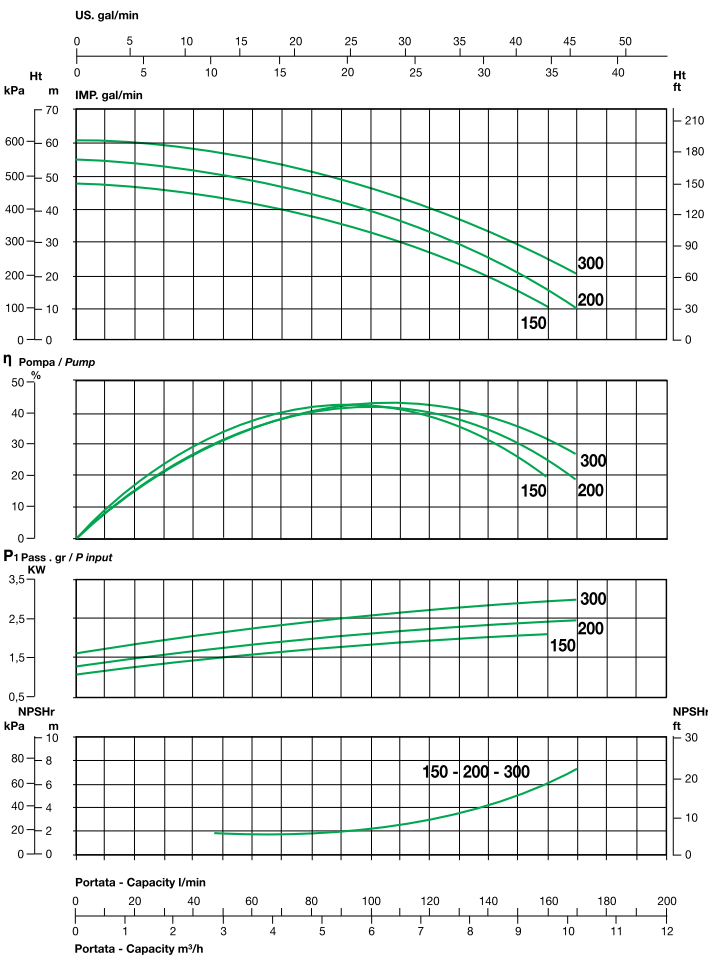
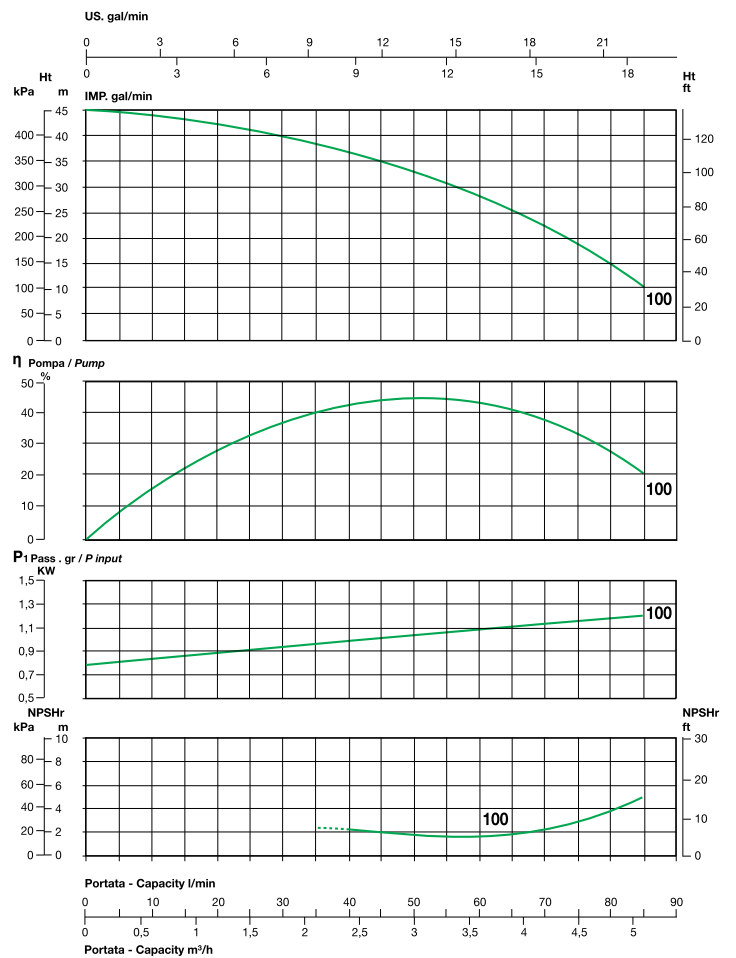
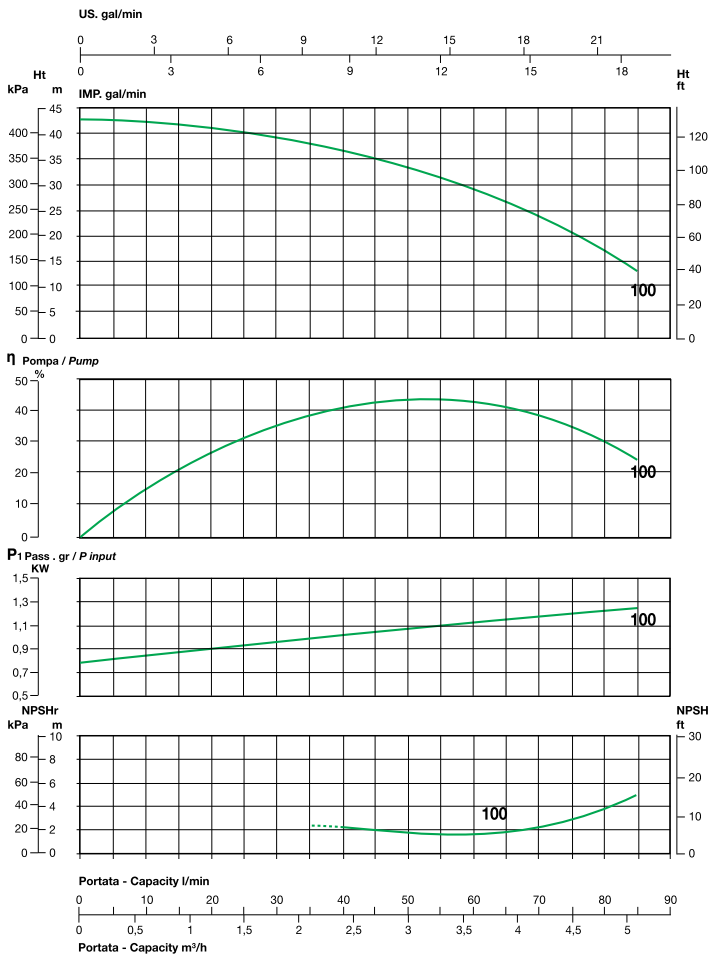

min⁻¹ ~ 2900

min⁻¹ ~ 3400

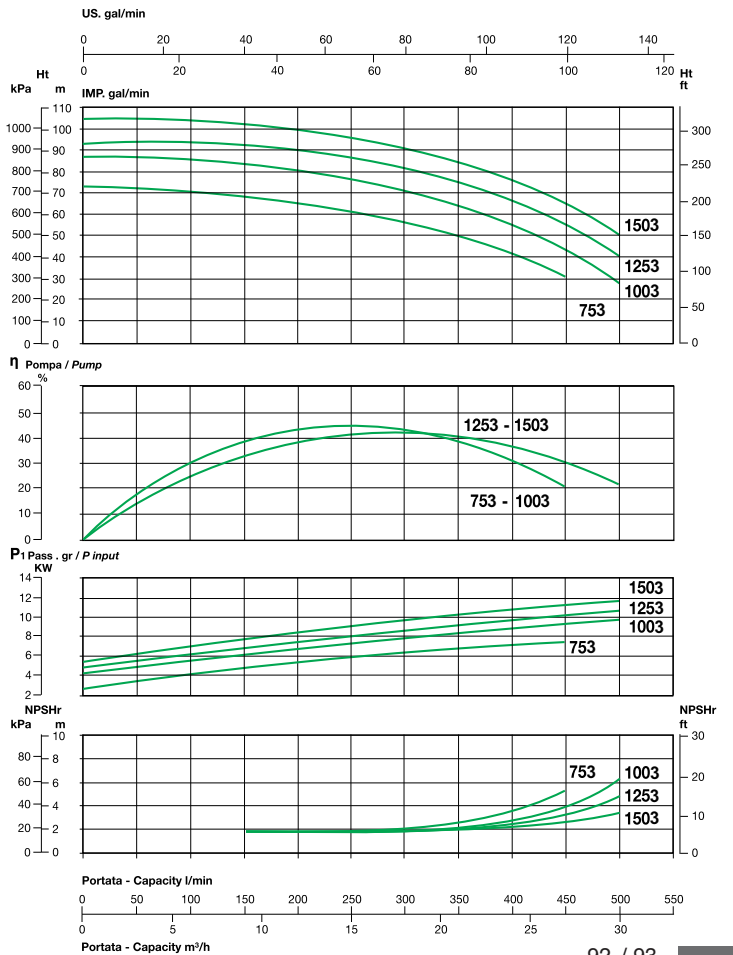
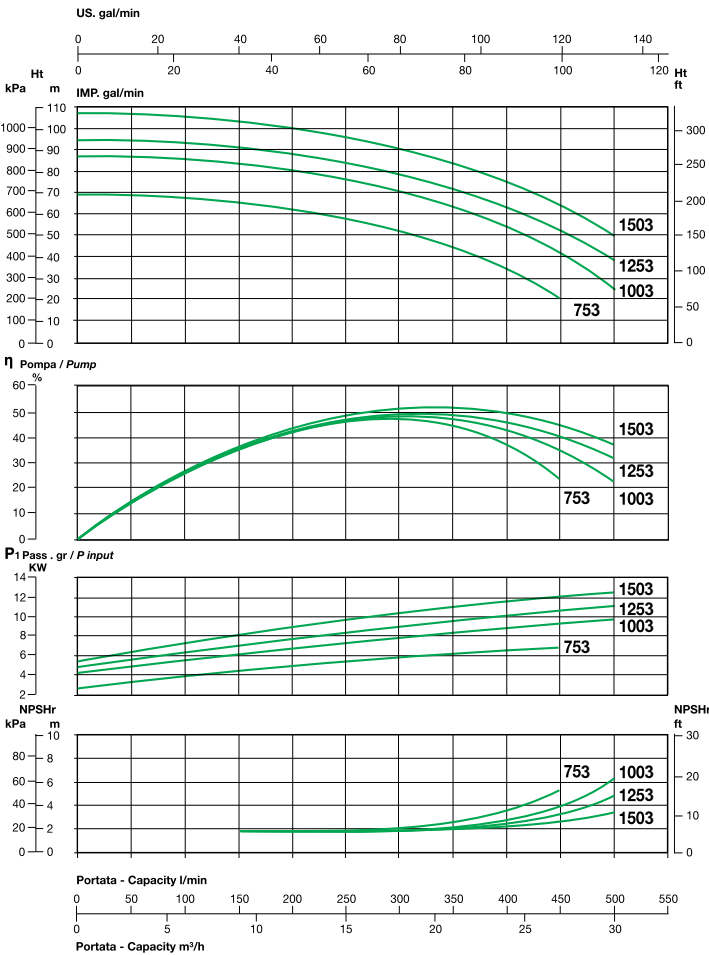
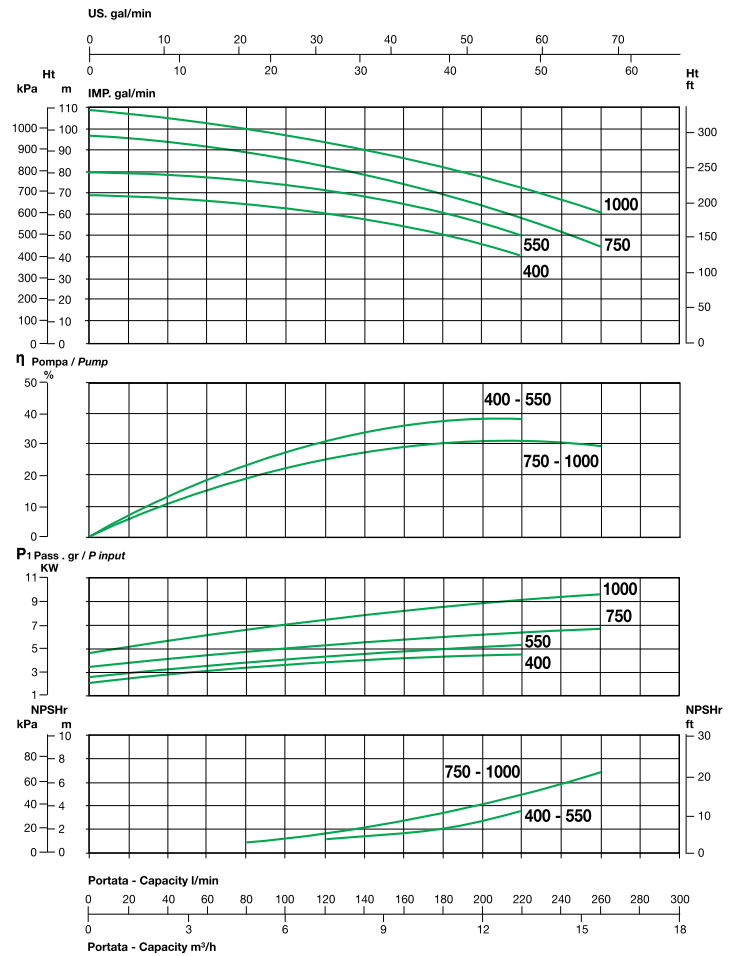
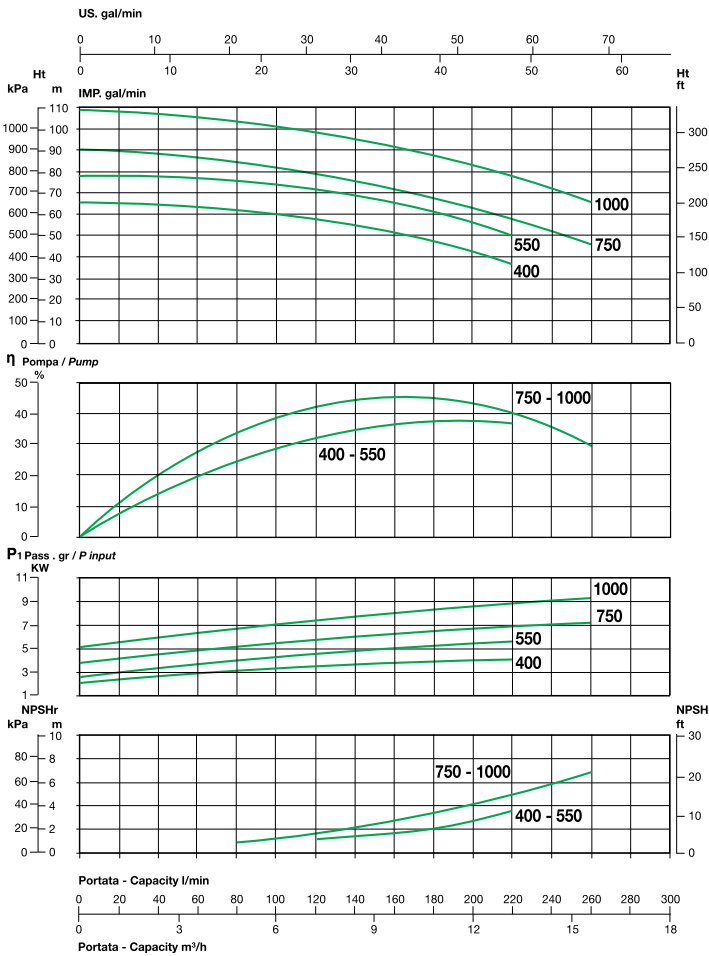

"CN"

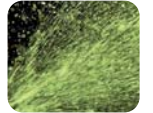

NOMENCLATURA PARTI DI RICAMBIO
SPARE PARTS LIST
NOMENCLATURE PIECES DE RECHANGE
NOMENCLATURA REPUESTOS

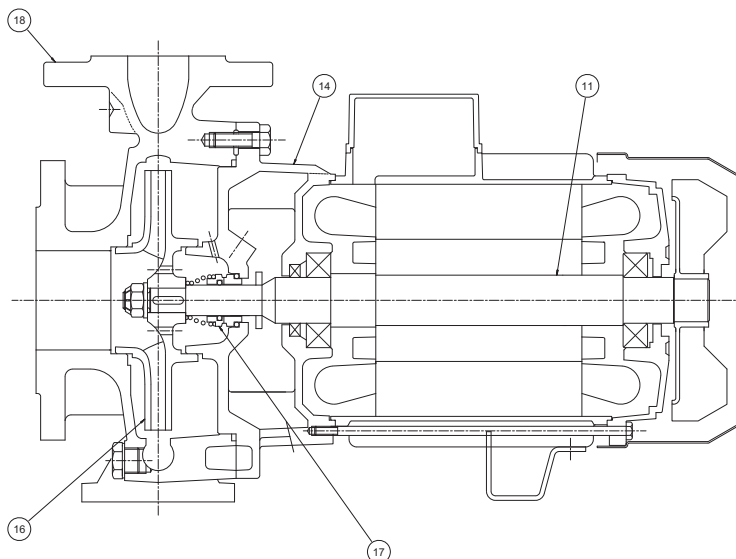

- 11** Albero con rotore – Pump shaft + rotor
Arbre + rotor – Eje rotor
- 14** Supporto mandata – Outlet bracket
Support envoyée – Soporte entrega
- 16** Girante – Impeller
Turbine – Impulsor
- 17** Tenuta meccanica – Mechanical seal
Garniture mécanique – Cierre mecánico
- 18** Corpo pompa – Pump body
Corp de pompe – Cuerpo bomba

ELETTROPOMPE CENTRIFUGHE MONOBLOCCO NORMALIZZATE

Le elettropompe centrifughe monoblocco della serie “CN” sono costruite in accordo con le normative UNI EN 733 (DIN 24255). Sono state progettate per il pompaggio di liquidi puliti, senza parti abrasive, senza corpi solidi in sospensione, non esplosivi o aggressivi per i materiali della pompa

- Temperatura max. del liquido fino a 35 °C per uso domestico (CEI EN 60335-2-41) o 90 °C per altri usi e temperatura ambiente fino a 40 °C.
- Portate fino a 180 m3/h.
- Prevalenze fino a 90 m.

CARATTERISTICHE COSTRUTTIVE

- Corpo pompa: ghisa G20 con trattamento anticorrosione
- Supporto motore: ghisa G20 con trattamento anticorrosione
- Bocche aspirazione/mandata: a norme DIN 2532
- Girante: ghisa G20 con trattamento anticorrosione
- Controflange filettate: acciaio zincato complete di guarnizioni in EPDM
- Albero pompa: acciaio inox Aisi 304
- Tenuta meccanica: carbone-ceramica

MOTORE

I motori di comando sono del tipo asincrono a gabbia di scoiattolo chiusi, a ventilazione esterna

- Motoprotettore incorporato e condensatore permanentemente inserito per i tipi monofasi
- La protezione del motore nella versione trifase è a cura del cliente e si raccomandano apparecchiature in accordo con le norme vigenti
- Isolamento classe F –servizio S1- grado di protezione IP 44
- Protezione morsettiera IP 54

ÉLECTROPOMPES CENTRIFUGES MONOBLOC NORMALISÉES

Les électropompes centrifuges monobloc de la série “CN” sont construites en accord avec les réglementations UNI EN 733 (DIN 24255). Elles ont été conçues pour le pompage de liquides propres, sans parties abrasives, sans corps liquides en suspension, non explosifs ou agressifs pour les matériaux de la pompe

- Température max. du liquide jusqu’à 35 °C pour utilisation domestique (CEI EN 60335-2-41) ou 90 °C pour d’autres utilisations et température ambiante jusqu’à 40 °C.
- Plage d’utilisation jusqu’à 180 m3/h.
- Hauteur manométrique jusqu’à 90 m.

CARACTERISTIQUES DE CONSTRUCTION

- Corps de pompe : En fonte G20 avec traitement anti-corrosion
- Lanterne: En fonte G20 avec traitement anti-corrosion
- Aspiration/refoulement : norme DIN 2532
- Turbine: En fonte G20 avec traitement anti-corrosion
- Contre brides filettées: en acier galvanisé avec joints en EPDM
- Abre de pompe: acier inox Aisi 304
- Garniture mécanique: Carbone dur - Céramique

MOTOR

Le moteurs sont asynchrones à cage d’écureuil fermés à ventilation extérieure monofásicos

- Pour le modèles monophasé son avec protection thermique et condensateur connecté en permanence
- Pour les modèles triphasés, la protection est à la charge de l’utilisateur. A recommandé l’équipement conformément à la réglementation
- A Classe d’isolation F - service S 1 – protection IP44
- Protection IP54 dans le terminal

NORMALIZED CLOSE COUPLED CENTRIFUGAL ELECTRIC PUMPS

The close-coupled electric pumps of the series “CN” are manufactured according to DIN 24255 (UNI EN 733) standards. They have been designed to pump clean liquids, without abrasives and suspended solids, non-explosive or aggressive for the pump’s materials.

- Liquid temperature not higher than 35 °C for domestic use (CEI EN 60335-2-41) or 90 °C for other use, while the ambient temperature must not be higher than 40 °C
- Flow rates up to 180 m3/h.
- Heads up to 90 m.

TECHNICAL FEATURES

- Pump body: cast iron G20 with anti-corrosive coating
- Motor bracket: cast iron G20 with anti-corrosive coating
- Orifices in/outlet: DIN 2532 standards
- Impeller: cast iron G20 with anti-corrosive coating
- Threaded counter flanges: galvanized steel complete with EPDM gaskets
- Pump shaft: stainless steel Aisi 304
- Mechanical seal: carbon-ceramics

MOTOR

The control motors are asynchronous, squirrel cage-type, closed, with external ventilation

- Incorporated motor protection and capacitor always on, for single-phase models
- The motor protection for three-phase models must be installed by the customer. Equipment compliant with current standards should be used
- Class of insulation:F-service:S1-Degree of protection :IP 44
- Terminal board protection: IP 54

ELECTROBOMBAS CENTRÍFUGAS MONOBLOQUE NORMALIZADAS

Las electrobombas centrifugas monobloque de la serie “CN” han sido construidas conforme las normativas UNI EN 733 (DIN 24255). Han sido proyectadas para bombear líquidos limpios sin partes abrasivas, sin cuerpos sólidos en suspensión, que no sean explosivos ni agresivos para los materiales de la bomba.

- Temperatura max. del líquido hasta 35 °C para uso doméstico (CEI EN 60335-2-41) o 90 °C para otros usos y temperatura ambiente hasta 40 °C.
- Caudal hasta 180 m3/h.
- Alturas hasta 90 m.

CARACTERÍSTICAS DE CONSTRUCCIÓN

- Cuerpo de bomba: Fundición gris G20 con tratamiento contra-corrosión
- Soporte: Fundición gris G20 con tratamiento contra-corrosión
- Bocas de entrada y salida : normalizadas DIN 2532
- Rodete: Fundición gris G20 con tratamiento contra-corrosión
- Contra bridas roscadas: de acero galvanizado con juntas de EPDM
- Eje de la bomba: de acero Inox AISI304
- Cierre mecánico: De cerámica y grafito

MOTOR

Los motores de accionamiento son asíncrono de jaula de ardilla cerrados, ventilados externamente

- Para los modelos monofásicos, protección térmica y condensador incorporado
- Para los modelos trifásicos de la protección se encarga el usuario. y el equipo recomendado de acuerdo con las normas
- Aislamiento de Clase F – funcionamiento S1- proteccion IP44
- Proteccion IP54 para el terminal

"CNG"

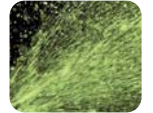

NOMENCLATURA PARTI DI RICAMBIO
SPARE PARTS LIST
NOMENCLATURE PIECES DE RECHANGE
NOMENCLATURA REPUESTOS

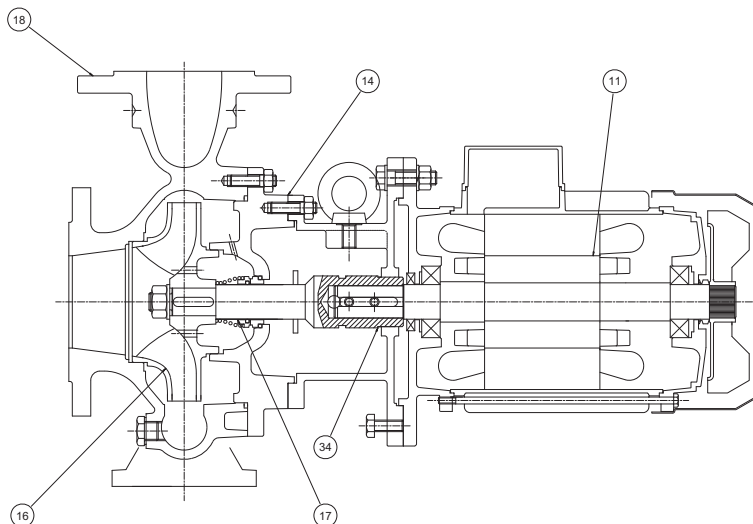

- 11** Albero con rotore – Pump shaft + rotor
Arbre + rotor – Eje rotor
- 14** Supporto mandata – Outlet bracket
Support envoyée – Soporte entrega
- 16** Girante – Impeller
Turbine – Impulsor
- 17** Tenuta meccanica – Mechanical seal
Garniture mécanique – Cierre mecánico
- 18** Corpo pompa – Pump body
Corp de pompe – Cuerpo bomba
- 34** Giunto – Coupling
Manchon – Acoplamiento

ELETTROPOMPE CENTRIFUGHE NORMALIZZATE CON GIUNTO RIGIDO E MOTORE NORMALIZZATO

Le elettropompe centrifughe con giunto rigido della serie "CNG" sono costruite in accordo con le normative UNI EN 733 (DIN 24255). Sono state progettate per il pompaggio di liquidi puliti, senza parti abrasive, senza corpi solidi in sospensione, non esplosivi o aggressivi per i materiali della pompa

- Temperatura max. del liquido fino a 35 °C per uso domestico (CEI EN 60335-2-41) o 90 °C per altri usi e temperatura ambiente fino a 40 °C.
- Portate fino a 240 m³/h.
- Prevalenze fino a 100 m.

CARATTERISTICHE COSTRUTTIVE

- Corpo pompa: ghisa G20 con trattamento anticorrosione
- Supporto motore: ghisa G20 con trattamento anticorrosione
- Bocche aspirazione/mandata: a norme DIN 2532
- Girante: ghisa G20 con trattamento anticorrosione
- Controflange filettate: acciaio zincato complete di guarnizioni in EPDM
- Albero pompa: acciaio inox Aisi 304
- Tenuta meccanica: carbone-ceramica

MOTORE

I motori di comando sono del tipo asincrono a gabbia di scoiattolo chiusi, a ventilazione esterna

- La protezione del motore nella versione trifase è a cura del cliente e si raccomandano apparecchiature in accordo con le norme vigenti
- Forme costruttive IM B3/B5
- Isolamento classe F – servizio S1- grado di protezione IP 44
- Protezione morsettiera IP 54

ÉLECTROPOMPES CENTRIFUGES NORMALISÉES À ACCOUPLEMENT PERMANENT ET MOTEUR NORMALISÉ

Les électropompes centrifuges à accouplement permanent de la série "CNG" sont construites en accord avec les réglementations UNI EN 733 (DIN 24255). Elles ont été conçues pour le pompage de liquides propres, sans parties abrasives, sans corps liquides en suspension, non explosifs ou agressifs pour les matériaux de la pompe

- Température max. du liquide jusqu'à 35 °C pour utilisation domestique (CEI EN 60335-2-41) o 90 °C pour d'autres utilisations et température ambiante jusqu'à 40 °C.
- Plage d'utilisation jusqu'à 240 m³/h.
- Hauteur manométrique jusqu'à 100 m.

CARACTERISTIQUES DE CONSTRUCTION

- Corps de pompe : En fonte G20 avec traitement anti-corrosion
- Lanterne: En fonte G20 avec traitement anti-corrosion
- Aspiration/refoulement : norme DIN 2532
- Turbine: En fonte G20 avec traitement anti-corrosion
- Contre brides filettées: en acier galvanisé avec joints en EPDM
- Abre de pompe: acier inox Aisi 304
- Garniture mécanique: Carbone dur - Céramique

MOTOR

Le moteurs sont asynchrones à cage d'écurieil fermés à ventilation extérieure monofásicos,

- Pour les modèles triphasés, la protection est à la charge de l'utilisateur. A recommandé l'équipement conformément à la réglementation
- A Classe d'isolation F - service S 1 – protection IP44
- Protection IP54 dans le terminal

NORMALIZED CENTRIFUGAL ELECTRIC PUMPS WITH STUB SHAFT AND STANDARD MOTOR

The electric pumps with stub shaft of the series "CNG" are manufactured according to DIN 24255 (UNI EN 733) standards. They have been designed to pump clean liquids, without abrasives and suspended solids, non-explosive or aggressive for the pump's materials.

- Liquid temperature not higher than 35 °C for domestic use (CEI EN 60335-2-41) or 90 °C for other use, while the ambient temperature must not be higher than 40 °C
- Flow rates up to 240 m³/h.
- Heads up to 100 m.

TECHNICAL FEATURES

- Pump body: cast iron G20 with anti-corrosive coating
- Motor bracket: cast iron G20 with anti-corrosive coating
- Orifices in/outlet: DIN 2532 standards
- Impeller: cast iron G20 with anti-corrosive coating
- Threaded counter flanges: galvanized steel complete with EPDM gaskets
- Pump shaft: stainless steel Aisi 304
- Mechanical seal: carbon-ceramics

MOTOR

The control motors are asynchronous, squirrel cage-type, closed, with external ventilation

- The motor protection for three-phase models must be installed by the customer. Equipment compliant with current standards should be used
- IM B3/B5 enclosure
- Class of insulation:F-service:S1-Degree of protection: IP 44
- Terminal board protection: IP 54

ELECTROBOMBAS CENTRÍFUGAS NORMALIZADAS CON ACOPLAMIENTO RÍGIDO Y MOTOR NORMALIZADO

Las electrobombas centrifugas con acoplamiento rígido de la serie "CNG" han sido construidas conforme las normativas UNI EN 733 (DIN 24255). Han sido proyectadas para bombear líquidos limpios sin partes abrasivas, sin cuerpos sólidos en suspensión, que no sean explosivos ni agresivos para los materiales de la bomba.

- Temperatura max. del líquido hasta 35 °C para uso doméstico (CEI EN 60335-2-41) o 90 °C para otros usos y temperatura ambiente hasta 40 °C.
- Caudal hasta 240 m³/h.
- Alturas hasta 100 m.

CARACTERÍSTICAS DE CONSTRUCCIÓN

- Cuerpo de bomba: Fundición gris G20 con tratamiento contra-corrosión
- Soporte: Fundición gris G20 con tratamiento contra-corrosión
- Bocas de entrada y salida : normalizadas DIN 2532
- Rodete: Fundición gris G20 con tratamiento contra-corrosión
- Contra bridas roscadas: de acero galvanizado con juntas de EPDM
- Eje de la bomba: de acero Inox AISI304
- Cierre mecánico: De cerámica y grafito

MOTOR

Los motores de accionamiento son asíncrono de jaula de ardilla cerrados, ventilados externamente

- Para los modelos trifásicos de la protección se encarga el usuario y el equipo recomendado de acuerdo con las normas
- Aislamiento de Clase F – funcionamiento S1- protección IP44
- Protección IP54 para el terminal

"ING"



NOMENCLATURA PARTI DI RICAMBIO
SPARE PARTS LIST
NOMENCLATURE PIECES DE RECHANGE
NOMENCLATURA REPUESTOS

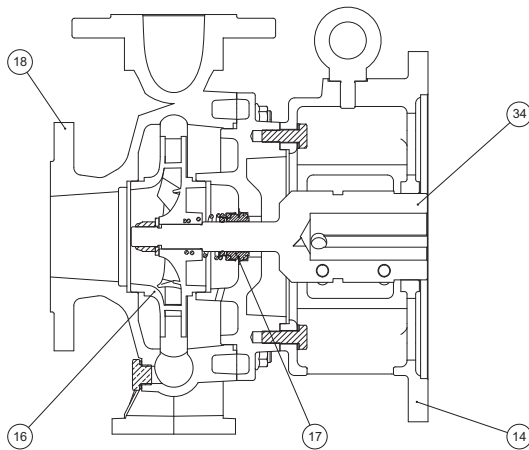

- 14** Supporto mandata – Outlet bracket
Support envoyée – Soporte entrega
- 16** Girante – Impeller
Turbine – Impulsor
- 17** Tenuta meccanica – Mechanical seal
Garniture mécanique – Cierre mecánico
- 18** Corpo pompa – Pump body
Corp de pompe – Cuerpo bomba
- 34** Giunto – Coupling
Manchon – Acoplamiento

POMPE CENTRIFUGHE NORMALIZZATE CON GIUNTO RIGIDO E MOTORE NORMALIZZATO

Le pompe centrifughe con giunto rigido della serie "ING" sono costruite in accordo con le normative UNI EN 733 (DIN 24255). Sono state progettate per il pompaggio di liquidi puliti, senza parti abrasive, senza corpi solidi in sospensione, non esplosivi o aggressivi per i materiali della pompa

- Temperatura max. del liquido fino a 35 °C per uso domestico (CEI EN 60335-2-41) o 90 °C per altri usi e temperatura ambiente fino a 40 °C.
- Portate fino a 240 m³/h.
- Prevalenze fino a 100 m.

CARATTERISTICHE COSTRUTTIVE

- Corpo pompa: ghisa G20 con trattamento anticorrosione
- Supporto motore: ghisa G20 con trattamento anticorrosione
- Bocche aspirazione/mandata: a norme DIN 2532
- Girante: ghisa G20 con trattamento anticorrosione
- Controflange filettate: acciaio zincato complete di guarnizioni in EPDM
- Albero pompa: acciaio inox Aisi 304
- Tenuta meccanica: carbone-ceramica
- Forme costruttive IM B3/B5

NORMALIZED CENTRIFUGAL PUMPS WITH STUB SHAFT AND STANDARD MOTOR

The pumps with stub shaft of the series "ING" are manufactured according to DIN 24255 (UNI EN 733) standards. They have been designed to pump clean liquids, without abrasives and suspended solids, non-explosive or aggressive for the pump's materials.

- Liquid temperature not higher than 35 °C for domestic use (CEI EN 60335-2-41) or 90 °C for other use, while the ambient temperature must not be higher than 40 °C
- Flow rates up to 240 m³/h.
- Heads up to 100 m.

TECHNICAL FEATURES

- Pump body: cast iron G20 with anti-corrosive coating
- Motor bracket: cast iron G20 with anti-corrosive coating
- Orifices in/outlet: DIN 2532 standards
- Impeller: cast iron G20 with anti-corrosive coating
- Threaded counter flanges: galvanized steel complete with EPDM gaskets
- Pump shaft: stainless steel Aisi 304
- Mechanical seal: carbon-ceramics
- IM B3/B5 enclosure

POMPE CENTRIFUGES NORMALISÉES À ACCOUPLEMENT PERMANENT ET MOTEUR NORMALISÉ

Les pompes centrifuges à accouplement permanent de la série "ING" sont construites en accord avec les réglementations UNI EN 733 (DIN 24255). Elles ont été conçues pour le pompage de liquides propres, sans parties abrasives, sans corps liquides en suspension, non explosifs ou agressifs pour les matériaux de la pompe

- Température max. du liquide jusqu'à 35 °C pour utilisation domestique (CEI EN 60335-2-41) ou 90 °C pour d'autres utilisations et température ambiante jusqu'à 40 °C.
- Plage d'utilisation jusqu'à 240 m³/h.
- Hauteur manométrique jusqu'à 100 m.

CARACTERISTIQUES DE CONSTRUCTION

- Corps de pompe : En fonte G20 avec traitement anti-corrosion
- Lanterne: En fonte G20 avec traitement anti-corrosion
- Aspiration/refoulement : norme DIN 2532
- Turbine: En fonte G20 avec traitement anti-corrosion
- Contre brides filettées: en acier galvanisé avec joints en EPDM
- Abre de pompe: acier inox Aisi 304
- Abre de pompe: acier inox Aisi 304
- Garniture mécanique: Carbone dur - Céramique
- Construction: B3/B5

BOMBAS CENTRÍFUGAS NORMALIZADAS CON ACOPLAMIENTO RÍGIDO Y MOTOR NORMALIZADO

Las bombas centrifugas con acoplamiento rígido de la serie "ING" han sido construidas conforme las normativas UNI EN 733 (DIN 24255). Han sido proyectadas para bombear líquidos limpios, sin partes abrasivas, sin cuerpos sólidos en suspensión, que no sean explosivos ni agresivos para los materiales de la bomba.

- Temperatura max. del líquido hasta 35 °C para uso doméstico (CEI EN 60335-2-41) o 90 °C para otros usos y temperatura ambiente hasta 40 °C.
- Caudal hasta 240 m³/h.
- Alturas hasta 100 m.

CARACTERÍSTICAS DE CONSTRUCCIÓN

- Cuerpo de bomba: Fundición gris G20 con tratamiento contra-corrosión
- Soporte: Fundición gris G20 con tratamiento contra-corrosión
- Bocas de entrada y salida : normalizadas DIN 2532
- Rodete: Fundición gris G20 con tratamiento contra-corrosión
- Contra bridas roscadas: de acero galvanizado con juntas de EPDM
- Eje de la bomba: de acero Inox AISI304
- Eje de la bomba: de acero Inox AISI304
- Cierre mecánico: De cerámica y grafito
- Construcción: B3/B5

50 Hz - min⁻¹ ~ 2900

TIPO TYPE	Monofase Single-phase	Trifase Three-phase	Potenza nominale Nominal power		Q [m3/h] Q [l/1']	Portata - Capacity																DNA mm	DNM mm							
			[kW]	[HP]		0	3	6	9	12	15	18	21	24	27	30	33	36	39	42	45			48	57	60	66	72	78	
						Prevalenza (m C.A.) Total head (m W.C.)																								
						21,5	21,0	20,5	20,0	18,5	17	14,5	12														50	32		
						26,0	26,5	26,5	26,0	24,0	22,5	20	16,5	12,5														50	32	
						30,5	30,5	30,0	29,5	28,5	27,5	25,5	23	20,5	17													50	32	
						37,0	37,5	37,5	37,0	36,5	34,5	33	31	28	25	22												50	32	
						44,0	44,5	44,0	43,0	42,0	41,0	39,0	37,5	35	32,5	30												50	32	
						51,0	51,5	51,0	50,5	50,0	48,0	46,5	45,0	42,5	40	38												50	32	
						59,5	59,5	59,5	59,0	58,0	57,5	56,0	54,5	52,5	50	47,5												50	32	
						75	75	75	74,5	74	73	72	70	68	65,5	62,5	60											50	32	
						89,5	89,5	89,5	89	88,5	88	87	85,5	83	81	77,5	74											50	32	
						98	98	98	98	98	98	97,5	96	94	92	87,5	83											50	32	
						17,5	17,8	18	19	18,3	18	17,5	17	16	15	13,5	12,5	11	8,5									65	40	
						22	22,3	22,5	22,5	22,5	22,3	22	21,5	20,5	19,5	18,5	18	16,5	14,5	12,5								65	40	
						26,5	27	27,5	27,5	27,5	27	26,5	26,3	25,5	25	23,7	23	21,5	19,5	17,5	16							65	40	
						31	31,2	31,5	31	30	29,8	28,5	27,5	27	25	23,5	22	19,5	17	14,5								65	40	
						38,5	39	38,8	38,5	37,8	37,5	36,5	35,5	34,5	33	32	29,5	27,5	25	23								65	40	
						44,5	44,5	44,8	45	44,5	44,3	43,5	43	42	40,5	39	37	34,5	32	29	25							65	40	
						54,5	54,8	55	55	55	55	54,8	54,5	53,8	53	51,5	49,5	48	45,5	43	40	36,5						65	40	
						72	72	72,5	72,3	72	71	70,5	70	69	68	66,5	65	63,5	61,5	59	56	54,5						65	40	
						84,5	85	85,5	85,8	85,5	85,5	85,2	85	84,5	84	82,5	81	79,5	78	75,5	73,5	70,5						65	40	
						17,5	18	18	18	18	18	18	17,8	17,5	17	16,5	16	15,5	15	14	13,5	12,5	10					65	50	
						22,5	22,5	22,5	22,5	22,5	22,5	22	21,8	21,5	21	20,5	20	19,5	19	18,5	17,5	17	14,5					65	50	
						25,5	25,8	26	26	26	25,8	25,5	25,3	25	24,8	24,5	24	23,5	23	22,5	22	19,5						65	50	
						31,5	32	32	32	32	32	31,8	31,5	31	30,5	30	29,7	29,5	28,5	28	27	26,5	23,5	22	19,5			65	50	
						39,5	40	40	40	40	40	40	40	39,8	39,5	39	38,5	38	37,7	37,5	37	36,5	34	33	31	28		65	50	
						45	46	46,5	46,7	47	47,3	47,5	47	46,5	46	45,5	45	44,5	43,5	42,5	41	40	34,5	32,5	28	23		65	50	
						52,5	53,5	54	54,5	54,5	54,5	54,5	54,3	54	53,8	53,5	52	51	50	49	47,5	46,5	42	39,5	35,5	30		65	50	
						59,5	60,5	61	61,5	61,5	61,5	61,3	61	60,5	60	59	58,5	57	56	55	53,5	48	46,5	42	37,5			65	50	
						73	73,5	74	74,5	75	75	75	75	75	74,8	74,5	73,5	72,5	72	71,5	71	70	67	65	62	58	54		65	50
						82	82,3	82,5	82,5	82,5	82,5	82,5	82,5	82,5	82,3	82	81,5	81	80	79,5	79	78	74	72,5	70	66,5	61,5		65	50
						89,5	90	90,5	90,8	91	91	91	90,8	90,5	90,2	90	89,5	89	88,5	88	87	86,5	83	80,5	78	74	69,5		65	50

CAMPO DELLE PRESTAZIONI / RANGE OF PERFORMANCES

50 Hz - min⁻¹ ~ 2900

TIPO TYPE	Monofase Single-phase	Trifase Three-phase	Potenza nominale Nominal power		Q [m3/h] Q [l/1']	Portata - Capacity																DNA mm	DNM mm								
			[kW]	[HP]		0	12	24	30	36	42	48	54	60	66	72	78	84	96	102	120			132	144	156	168	180	192	240	
						Prevalenza (m C.A.) Total head (m W.C.)																									
						23,5	24,5	25,0	25,0	24,5	24	23,5	23	22,5	21,5	20,5	19	16	14										80	65	
						26,0	26,5	27,0	27,0	26,8	26,6	26,4	26	26	24,5	23,5	23	21,5	18,5	17									80	65	
						31,5	32,5	33,5	34,0	34,0	33,5	33	32,8	32,5	32	31	30	29,5	27,5	26,5	22								80	65	
						36,5	38,0	38,5	39,0	39,0	39	38,8	38,5	38,2	38	37	36,5	35,5	33,5	32,5	28								80	65	
						41,5	43,5	44,5	44,8	44,8	45,0	44,8	44,5	44,2	44	43,5	43	42	40	39	34,5								80	65	
						44,5	45,5	46,5	46,5	46,5	46,5	46,5	46,2	46	45,8	45,5	45	44,5	42,5	41,5	37,5	34,5	30,5					80	65		
						48,0	49,5	50,0	50,2	50,5	50,5	50,5	50,2	50	49,8	49,5	49	48,5	47	46	42,5	39	35,5					80	65		
						52,5	53,5	54	54,5	54,7	54,8	54,8	54,5	54	53,5	53,5	53	52	51	47,5	44,5	41						80	65		
						71	71,5	72,5	72,5	73	73	73	72,8	72,5	72,5	72	71,5	71	70	69	65,5	63	59,5					80	65		
						79,5	81	81,5	82	82,5	82,5	82,5	82,5	82,5	82	81,8	81,5	81	79,8	79	75,5	73	69,5					80	65		
						18	19	20	20,2	20,4	20,5	20,5	20	19,8	19,5	19	18,5	18	16,5	15,5	12,5	10,5	8					100	80		
						24	25,5	25,8	26	26	26	26	26	25,5	25	24,5	24	23,8	22,5	22	19,5	17,5	15					100	80		
						27	28,3	28,8	29	29,5	29,7	29,8	29,8	29,8	29,8	29,5	29,2	29	28,5	28	26,5	25	23,5	22	20			100	80		
						32	33	33,5	34	34,5	34,7	34,5	34,5	34,5	34,5	34,5	34,2	34	33,5	33	32	30,5	29	27,5	26			100	80		
						35	36	36,5	37	37,5	37,5	37,5	37,5	37,5	37,5	37,5	37,5	37	37	36,5	35	34,5	33	32	30			100	80		
						39	39,5	40	40,5	41	41	41	41,5	41,5	41,5	41,2	41	40,5	40	39	38	37,5	36,5	35				100	80		
						53	53,5	54	54,5	54,8	55	55	55	55	55,3	55,5	55,5	55,8	56	56	56,3	56	55,3	54	49,5	40		100	80		
						62,5	63	63,5	64	64,5	64,8	64,8	65	65	65	65,3	65,5	65,5	66	66	66,3	66	65,5	65	63	59	53		100	80	
						67,5	68,5	69	69,5	70	70	70	70	70	70	70	70	70	70	70	70	70	68,5	67,5	66	65	63	60,5	50	100	80
						82	83,5	85	86	86,5	87	87	87,5	88	88	88	88	88	87,5	87,5	86	85	83,5	82	81	79,5	70		100	80	
						101,5	101,8	102	102,5	103	103	103	103,5	103,5	104	104	104	104	104	104,5	104,5	103,5	103	102,5	102	101,5	100	92	100	80	

CAMPO DELLE PRESTAZIONI / RANGE OF PERFORMANCES

° Disponibile anche in versione giunto rigido "CNG"
 ° Also available in rigid coupling "CNG"
 ° Aussi disponible en accouplement rigide "CNG"
 ° Disponible en acoplamiento rigido también "CNG"

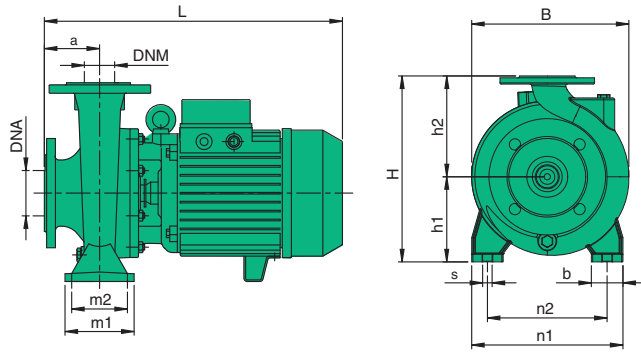

Flange - Flanges - Brides - Bridas
mm

DN	K	D	B	fori - holes - orifices - orificios	
				n°	∅
32	100	140	18	4	18
40	110	150	18	4	18
50	125	165	19	4	18
65	145	185	19	4	18
80	160	200	22	4	18
100	180	220	24	8	18

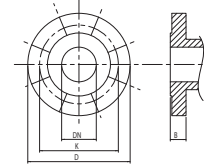

TIPO TYPE	DIMENSIONI [mm] DIMENSIONS [mm]														IMBALLO [mm] PACKING [mm]			PESO WEIGHT [kg]
	a	b	s	L	B	H	n1	n2	m1	m2	h1	h2	DNA	DNM	A	L	P	
CN 32 125B	80	50	14	400	203	252	190	140	100	70	112	140	50	32	380	290	520	38
CN 32 125A	80	50	14	400	203	252	190	140	100	70	112	140	50	32	380	290	520	40
CN 32 160B	80	50	14	437	240	292	240	190	100	70	132	160	50	32	380	290	520	43,5
CN 32 160A	80	50	14	400	240	292	240	190	100	70	132	160	50	32	380	290	520	51
CN 32 200C	80	50	14	468	273	340	240	190	100	70	160	180	50	32	380	290	520	55,5
CN 32 200B	80	50	14	495	273	340	240	190	100	70	160	180	50	32	550	350	580	67,5
CN 32 200A	80	50	14	537	273	340	240	190	100	70	160	180	50	32	560	350	700	81,5
CN 32 250C	100	65	14	561	326	405	320	250	125	95	180	225	50	32	560	350	700	98
CN 32 250B	100	65	14	600	326	405	320	250	125	95	180	225	50	32	560	350	700	105
CN 32 250A	100	65	14	682	326	405	320	250	125	95	180	225	50	32	570	470	890	148
CN 40 125C	80	50	14	400	216	252	210	160	100	70	112	140	65	40	380	290	520	38
CN 40 125B	80	50	14	437	216	252	210	160	100	70	112	140	65	40	380	290	520	43
CN 40 125A	80	50	14	463	216	252	210	160	100	70	112	140	65	40	380	290	520	48
CN 40 160B	80	50	14	463	242	292	240	190	100	70	132	160	65	40	380	290	520	50
CN 40 160A	80	50	14	463	242	292	240	190	100	70	132	160	65	40	380	290	520	52
CN 40 200B	100	50	14	515	278	340	265	212	100	70	160	180	65	40	550	350	580	71
CN 40 200A	100	50	14	557	278	340	265	212	100	70	160	180	65	40	560	350	700	84,5
CN 40 250B	100	65	14	600	328	405	320	250	125	95	180	225	65	40	560	350	700	104,5
CN 40 250A	100	65	14	682	328	405	320	250	125	95	180	225	65	40	570	470	890	149
CN 50 125C	100	50	14	457	248	292	240	190	100	70	132	160	65	50	380	290	520	45
CN 50 125B	100	50	14	483	248	292	240	190	100	70	132	160	65	50	380	290	520	41,5
CN 50 125A	100	50	14	483	248	292	240	190	100	70	132	160	65	50	380	290	520	52
CN 50 160B	100	50	14	515	268	340	265	212	100	70	160	180	65	50	550	350	580	67,5
CN 50 160A	100	50	14	557	268	340	265	212	100	70	160	180	65	50	560	350	700	80,5
CN 50 200C	100	50	14	561	290	360	265	212	100	70	160	200	65	50	560	350	700	92,5
CN 50 200B	100	50	14	600	290	360	265	212	100	70	160	200	65	50	560	350	700	99,5
CN 50 200A	100	50	14	682	290	360	265	212	100	70	160	200	65	50	570	470	890	141
CN 50 250C	100	65	14	682	334	405	320	250	125	95	180	225	65	50	570	470	890	151
CN 50 250B	100	65	14	682	334	405	320	250	125	95	180	225	65	50	570	470	890	156
CN 50 250A	100	65	14	726	334	405	320	250	125	95	180	225	65	50	570	470	890	168
CN 65 125B	100	65	14	515	283	340	280	212	125	95	160	180	80	65	550	350	580	68,5
CN 65 125A	100	65	14	557	283	340	280	212	125	95	160	180	80	65	560	350	700	81,5
CN 65 160C	100	65	14	565	290	360	280	212	125	95	160	200	80	65	560	350	700	92,5
CN 65 160B	100	65	14	605	290	360	280	212	125	95	160	200	80	65	560	350	700	99
CN 65 160A	100	65	14	686	290	360	280	212	125	95	160	200	80	65	570	470	890	142
CN 65 200C	100	65	14	686	330	405	320	250	125	95	180	225	80	65	570	470	890	144,5
CN 65 200B	100	65	14	686	330	405	320	250	125	95	180	225	80	65	570	470	890	151
CN 65 200A	100	65	14	730	330	405	320	250	125	95	180	225	80	65	570	470	890	162
CN 80 125B	100	65	14	520	285	340	280	212	125	95	160	180	100	80	550	350	580	73
CN 80 125A	100	65	14	561	285	340	280	212	125	95	160	180	100	80	560	350	700	86
CN 80 160D	125	65	14	628	330	405	320	250	125	95	180	225	100	80	560	350	700	106
CN 80 160C	125	65	14	710	330	405	320	250	125	95	180	225	100	80	570	470	890	147,5
CN 80 160B	125	65	14	710	330	405	320	250	125	95	180	225	100	80	570	470	890	153,5
CN 80 160A	125	65	14	755	330	405	320	250	125	95	180	225	100	80	570	470	890	164,5

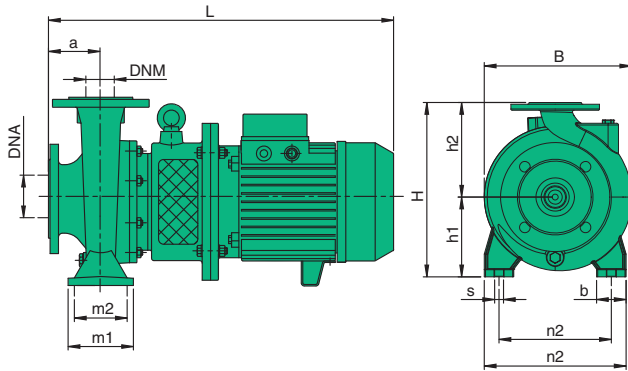

Flange - Flanges - Brides - Bridas
mm

DN	K	D	B	fori - holes - orifices - orificios	
				n°	∅
32	100	140	18	4	18
40	110	150	18	4	18
50	125	165	19	4	18
65	145	185	19	4	18
80	160	200	22	4	18
100	180	220	24	8	18

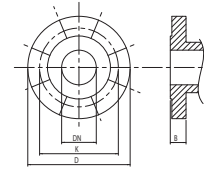

TIPO TYPE	DIMENSIONI [mm] DIMENSIONS [mm]													IMBALLO [mm] PACKING [mm]			PESO WEIGHT [kg]	
	a	b	s	L	B	H	n1	n2	m1	m2	h1	h2	DNA	DNM	A	L		P
CNG 32 200B	80	50	14	700	273	340	240	190	100	70	160	180	50	32	420	360	760	103
CNG 32 200A	80	50	14	740	273	340	240	190	100	70	160	180	50	32	420	360	760	109,5
CNG 32 250C	100	65	14	760	326	405	320	250	125	95	180	225	50	32	580	510	970	136
CNG 32 250B	100	65	14	800	326	405	320	250	125	95	180	225	50	32	580	510	970	193,5
CNG 32 250A	100	65	14	890	326	405	320	250	125	95	180	225	50	32	580	510	970	204
CNG 40 200B	100	50	14	720	278	340	265	212	100	70	160	180	65	40	420	360	760	106
CNG 40 200A	100	50	14	760	278	340	265	212	100	70	160	180	65	40	420	360	760	112
CNG 40 250B	100	65	14	800	328	405	320	250	125	95	180	225	65	40	580	510	970	195
CNG 40 250A	100	65	14	890	328	405	320	250	125	95	180	225	65	40	580	510	970	205,5
CNG 50 160B	100	50	14	720	268	340	265	212	100	70	160	180	65	50	420	360	760	102,5
CNG 50 160A	100	50	14	760	268	340	265	212	100	70	160	180	65	50	420	360	760	109
CNG 50 200C	100	50	14	760	290	360	265	212	100	70	160	200	65	50	580	510	970	130
CNG 50 200B	100	50	14	800	290	360	265	212	100	70	160	200	65	50	580	510	970	187,5
CNG 50 200A	100	50	14	890	290	360	265	212	100	70	160	200	65	50	580	510	970	198
CNG 50 250C	100	65	14	890	334	405	320	250	125	95	180	225	65	50	580	510	970	205
CNG 50 250B	100	65	14	890	334	405	320	250	125	95	180	225	65	50	650	570	1080	226
CNG 50 250A	100	65	14	930	334	405	320	250	125	95	180	225	65	50	650	570	1080	257
CNG 65 125B	100	65	14	720	283	340	280	212	125	95	160	180	80	65	420	360	760	102
CNG 65 125A	100	65	14	760	283	340	280	212	125	95	160	180	80	65	420	360	760	108,5
CNG 65 160C	100	65	14	765	290	360	280	212	125	95	160	200	80	65	580	510	970	131
CNG 65 160B	100	65	14	810	290	360	280	212	125	95	160	200	80	65	580	510	970	188,5
CNG 65 160A	100	65	14	890	290	360	280	212	125	95	160	200	80	65	580	510	970	199
CNG 65 200C	100	65	14	890	330	405	320	250	125	95	180	225	80	65	580	510	970	201,5
CNG 65 200B	100	65	14	890	330	405	320	250	125	95	180	225	80	65	650	570	1080	222
CNG 65 200A	100	65	14	930	330	405	320	250	125	95	180	225	80	65	650	570	1080	252,5
CNG 65 250B	100	80	18	1062	375	450	360	280	160	120	200	250	80	65	770	680	1300	318,5
CNG 65 250A	100	80	18	1062	375	450	360	280	160	120	200	250	80	65	770	680	1300	345,5
CNG 80 125B	100	65	14	720	285	340	280	212	125	95	160	180	100	80	420	360	760	105
CNG 80 125A	100	65	14	861	285	340	280	212	125	95	160	180	100	80	420	360	760	111,5
CNG 80 160D	125	65	14	828	330	405	320	250	125	95	180	225	100	80	580	510	970	192,5
CNG 80 160C	125	65	14	910	330	405	320	250	125	95	180	225	100	80	580	510	970	203
CNG 80 160B	125	65	14	910	330	405	320	250	125	95	180	225	100	80	650	570	1080	223,5
CNG 80 160A	125	65	14	955	330	405	320	250	125	95	180	225	100	80	650	570	1080	254
CNG 80 200B	125	65	18	1087	370	430	345	280	125	95	180	250	100	80	770	680	1300	327
CNG 80 200A	125	65	18	1087	370	430	345	280	125	95	180	250	100	80	770	680	1300	354
CNG 80 250C	125	80	18	1132	420	480	400	315	160	120	200	280	100	80	770	680	1300	454
CNG 80 250B	125	80	18	1260	420	480	400	315	160	120	200	280	100	80	770	680	1300	530
CNG 80 250A	125	80	18	1320	420	480	400	315	160	120	200	280	100	80	770	680	1300	681

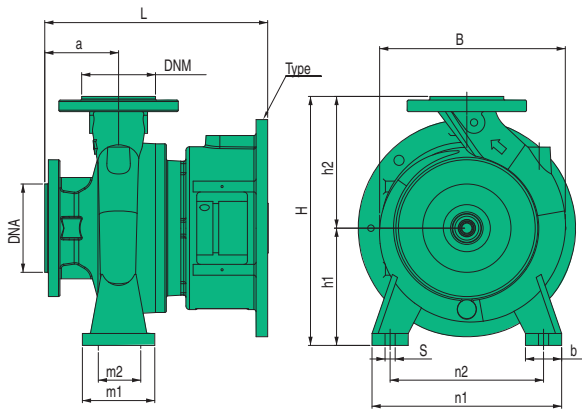

Flange - Flanges - Brides - Bridas
mm

DN	K	D	B	fori - holes - orifices - orificios	
				n°	Ø
32	100	140	18	4	18
40	110	150	18	4	18
50	125	165	19	4	18
65	145	185	19	4	18
80	160	200	22	4	18
100	180	220	24	8	18

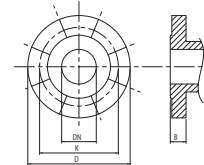

TIPO TYPE	DIMENSIONI [mm] DIMENSIONS [mm]														Motor MEC Size Motor	Flangia Coupling	IMBALLO [mm] PACKING [mm]		
	a	b	s	L	B	H	n1	n2	m1	m2	h1	h2	DNA	DNM	Type	Type	A	L	P
ING 32 200B	80	50	14	286	273	340	240	190	100	70	160	180	50	32	132	B5	410	550	320
ING 32 200A	80	50	14	286	273	340	240	190	100	70	160	180	50	32	132	B5	410	550	320
ING 32 250C	100	65	14	341	326	405	320	250	125	95	180	225	50	32	132	B5	410	550	320
ING 32 250B	100	65	14	341	326	405	320	250	125	95	180	225	50	32	160	B5	440	630	360
ING 32 250A	100	65	14	341	326	405	320	250	125	95	180	225	50	32	160	B5	440	630	360
ING 40 200B	100	50	14	307	278	340	265	212	100	70	160	180	65	40	132	B5	410	550	320
ING 40 200A	100	50	14	307	278	340	265	212	100	70	160	180	65	40	132	B5	410	550	320
ING 40 250B	100	65	14	343	328	405	320	250	125	95	180	225	65	40	160	B5	440	630	360
ING 40 250A	100	65	14	343	328	405	320	250	125	95	180	225	65	40	160	B5	440	630	360
ING 50 160B	100	50	14	306	268	340	265	212	100	70	160	180	65	50	132	B5	410	550	320
ING 50 160A	100	50	14	306	268	340	265	212	100	70	160	180	65	50	132	B5	410	550	320
ING 50 200C	100	50	14	342	290	360	265	212	100	70	160	200	65	50	132	B5	410	550	320
ING 50 200B	100	50	14	342	290	360	265	212	100	70	160	200	65	50	160	B5	440	630	360
ING 50 200A	100	50	14	342	290	360	265	212	100	70	160	200	65	50	160	B5	440	630	360
ING 50 250C	100	65	14	342	334	405	320	250	125	95	180	225	65	50	160	B5	440	630	360
ING 50 250B	100	65	14	342	334	405	320	250	125	95	180	225	65	50	160	B5	440	630	360
ING 50 250A	100	65	14	342	334	405	320	250	125	95	180	225	65	50	180	B5	440	630	360
ING 65 125B	100	65	14	310	283	340	280	212	125	95	160	180	80	65	132	B5	410	550	320
ING 65 125A	100	65	14	310	283	340	280	212	125	95	160	180	80	65	132	B5	410	550	320
ING 65 160C	100	65	14	347	290	360	280	212	125	95	160	200	80	65	132	B5	410	550	320
ING 65 160B	100	65	14	347	290	360	280	212	125	95	160	200	80	65	160	B5	440	630	360
ING 65 160A	100	65	14	347	290	360	280	212	125	95	160	200	80	65	160	B5	440	630	360
ING 65 200C	100	65	14	349	330	405	320	250	125	95	180	225	80	65	160	B5	440	630	360
ING 65 200B	100	65	14	349	330	405	320	250	125	95	180	225	80	65	160	B5	440	630	360
ING 65 200A	100	65	14	349	330	405	320	250	125	95	180	225	80	65	180	B5	440	630	360
ING 65 250B	100	80	18	350	375	450	360	280	160	120	200	250	80	65	200	B5	500	500	500
ING 65 250A	100	80	18	350	375	450	360	280	160	120	200	250	80	65	200	B5	500	500	500
ING 80 125B	100	65	14	311	285	340	280	212	125	95	160	180	100	80	132	B5	410	550	320
ING 80 125A	100	65	14	311	285	340	280	212	125	95	160	180	100	80	132	B5	410	550	320
ING 80 160D	125	65	14	373	330	405	320	250	125	95	180	225	100	80	160	B5	440	630	360
ING 80 160C	125	65	14	373	330	405	320	250	125	95	180	225	100	80	160	B5	440	630	360
ING 80 160B	125	65	14	373	330	405	320	250	125	95	180	225	100	80	160	B5	440	630	360
ING 80 160A	125	65	14	373	330	405	320	250	125	95	180	225	100	80	180	B5	440	630	360
ING 80 200B	125	65	18	394	370	430	345	280	125	95	180	250	100	80	200	B5	500	500	500
ING 80 200A	125	65	18	394	370	430	345	280	125	95	180	250	100	80	200	B5	500	500	500
ING 80 250C	125	80	18	423	420	480	400	315	160	120	200	280	100	80	200	B5	500	500	500
ING 80 250B	125	80	18	423	420	480	400	315	160	120	200	280	100	80	250	B5	500	500	500
ING 80 250A	125	80	18	423	420	480	400	315	160	120	200	280	100	80	280	B5	500	500	500

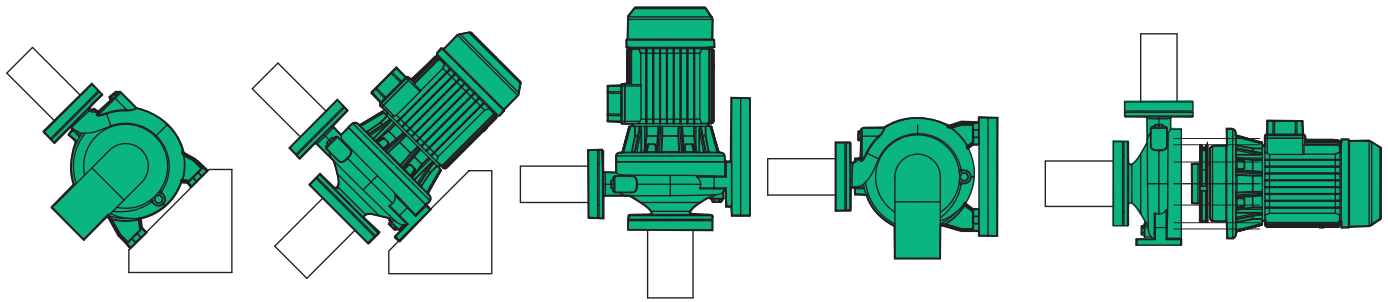

MOTOR TYPE MOTOR TYPE		IEC SIZE	INPUT CURRENT A SINGLE-PHASE			Noise Lpa/dB	MOTOR 230V - 50Hz				
kW	HP	MEC	230V			70	min ⁻¹	ls/lm	Cos φ	Nm	Ts/Tn
1,1	1,5	80	7,50	-	-	70	2830	6,78	0,94	3,70	3,49
1,5	2,0	90	9,30	-	-	70	2835	7,44	0,90	5,10	3,08
2,2	3,0	100	12,80	-	-	70	2795	9,36	0,98	7,50	3,98
3,0	4,0	100	18,20	-	-	70	2800	9,89	0,95	2,00	4,07

MOTOR TYPE MOTOR TYPE		IEC SIZE	INPUT CURRENT A THREE-PHASE			Noise Lpa/dB	MOTOR 400V - 50Hz				
kW	HP	MEC	230V	400V	690V	70	min ⁻¹	ls/lm	Cos φ	Nm	Ts/Tn
1,1	1,5	80	4,6	2,7	-	70	2875	6,78	0,77	3,65	3,49
1,5	2	90	5,3	3	-	70	2885	7,44	0,85	4,97	3,08
2,2	3	90	8,1	4,7	-	70	2890	8,3	0,79	7,3	3,72
3	4	100	10	5,8	-	70	2910	9,36	0,85	9,84	3,98
4	5,5	112	16	7,6	-	71	2890	8,62	0,87	13,2	3,5
5,5	7,5	132	-	10,7	6,2	71	2935	9,82	0,83	17,9	3,47
7,5	10	132	-	13,9	8	71	2925	9,52	0,87	24,5	3,24
9,2	12,5	132	-	17	9,3	71	2920	8,72	0,88	28,6	2,14
11	15	160	-	20	11,5	73	2940	7,59	0,89	35,7	2,11
15	20	160	-	26,3	15,3	78	2945	8,23	0,89	48,6	2,37
18,5	25	160	-	33	20	80	2955	9,25	0,86	59,8	2,62
22	30	180	-	41,7	24,1	80	2930	7,1	0,84	72	2,5
30	40	200	-	54	31,3	80	2950	6,8	0,87	97	2,4
37	50	200	-	65	37,5	80	2950	7,2	0,88	120	2,5
45	60	200	-	80	46	84	2960	6,7	0,88	145	2,4
55	75	250	-	99	57	84	2955	6,7	0,87	178	2,4
75	100	280	-	133	77	84	2960	6,8	0,87	242	2,3

MOTOR TYPE MOTOR TYPE		IEC SIZE	INPUT CURRENT A SINGLE-PHASE		Noise Lpa/dB	MOTOR 220V - 60Hz				
kW	HP	MEC	220V		70	min ⁻¹	ls/lm	Cos φ	Nm	Ts/Tn
1,10	1,50	80	8,00	-	70	3420	6,78	0,94	3,70	3,49
1,50	2,00	90	9,80	-	70	3435	7,44	0,90	5,10	3,08
2,20	3,00	100	13,40	-	70	3480	9,36	0,98	7,50	3,98
3,0	4,0	100	18,20	-	70	3400	9,89	0,95	2,00	4,07

MOTOR TYPE MOTOR TYPE		IEC SIZE	INPUT CURRENT A THREE-PHASE		Noise Lpa/dB	MOTOR 380V - 60Hz				
kW	HP	MEC	220V	380V	70	min ⁻¹	ls/lm	Cos φ	Nm	Ts/Tn
1,1	1,5	80	4,2	2,5	70	3420	6,26	0,88	3,07	2,52
1,5	2	90	5,8	3,3	70	3435	5,14	0,89	4,17	1,71
2,2	3	90	7,9	4,6	70	3445	7,23	0,89	6,11	2,79
3	4	100	10,5	6	70	3480	7,1	0,89	8,36	2,96
4	5,5	112	13	7,7	71	3475	7,2	0,93	11,1	2,46
5,5	7,5	132,0	18,3	10,6	71	3465	8,09	0,91	14,9	2,48
7,5	10	132	24	14	71	3505	7,54	0,91	20,4	2,31
9,2	12,5	132	31	18	71	3520	5,9	0,91	26	2,2
11	15	160	35	21	73	3520	6,04	0,92	29,9	1,6
15	20	160	47	27	78	3525	6,5	0,92	40,6	1,77
18,5	25	160	57	33,2	80	3540	7,94	0,91	50	2,2
22	30	180	74	43	80	3516	5,3	0,8	35	1,9
30	40	200	97	56	80	3540	5,1	0,9	45	1,8
37	50	200	116	67	80	3540	5,4	0,9	54	1,9
45	60	200	143	83	84	3552	5	0,9	67	1,8
55	75	250	176	103	84	3546	5	0,9	83	1,8
75	100	280	235	138	84	3556	5,1	0,9	111	1,7

EFFICIENCY CLASSES OF MOTOR - IE CODE 50 Hz

Output kW	IE1 code Standard Efficiency		IE2 code Standard Efficiency		IE3 code Standard Efficiency	
	2 poles	4 poles	2 poles	4 poles	2 poles	4 poles
1,10	75,00	75,00	79,60	81,40	82,70	84,10
1,50	77,20	77,20	81,30	82,80	84,20	85,30
2,20	79,70	79,70	83,20	84,30	85,90	86,70
3,00	81,50	81,50	84,60	85,50	87,10	87,70
4,00	83,10	83,10	85,80	86,60	88,10	88,60
5,50	84,70	84,70	87,00	87,70	89,20	89,60
7,50	86,00	86,00	88,10	88,70	90,10	90,40
11,00	87,60	87,60	89,40	89,80	91,20	91,40
15,00	88,70	88,70	90,30	90,60	91,90	92,10
18,50	89,30	89,30	90,90	91,20	92,40	92,60
22,00	89,90	89,90	91,30	91,60	92,70	93,00
30,00	90,70	90,70	92,00	92,30	93,30	93,60
37,00	91,20	91,20	92,50	92,70	93,70	93,90
45,00	91,70	91,70	92,90	93,10	94,00	94,20
55,00	92,10	92,10	93,20	93,50	94,30	94,60
75,00	92,70	92,70	93,80	94,00	94,70	95,00

EFFICIENCY CLASSES OF MOTOR - IE CODE 60 Hz

Output kW	IE1 code Standard Efficiency		IE2 code Standard Efficiency		IE3 code Standard Efficiency	
	2 poles	4 poles	2 poles	4 poles	2 poles	4 poles
1,1	78,50	79,00	82,50	84,00	84,00	86,50
1,5	81,00	81,50	84,00	84,00	85,50	86,50
2,2	81,50	83,00	85,50	87,50	86,50	89,50
3,0	84,50	85,00	87,50	87,50	88,50	89,50
4,0	84,50	85,00	87,50	87,50	88,50	89,50
5,5	86,00	87,00	88,50	89,50	89,50	91,70
7,5	87,50	87,50	89,50	89,50	90,20	91,70
11,0	87,50	88,50	90,20	91,00	91,00	92,40
15,0	88,50	89,50	90,20	91,00	91,00	93,00
18,5	89,50	90,50	91,00	92,40	91,70	93,60
22,0	89,50	91,00	91,00	92,40	91,70	93,60
30,0	90,20	91,70	91,70	93,00	92,40	94,10
37,0	91,50	92,40	92,40	93,00	93,00	94,50
45,0	91,70	93,00	93,00	93,60	93,60	95,00
55,0	92,40	93,00	93,00	94,10	93,60	95,40
75,0	93,00	93,20	93,60	94,50	94,10	95,40

min⁻¹ ~ 2900

min⁻¹ ~ 3400

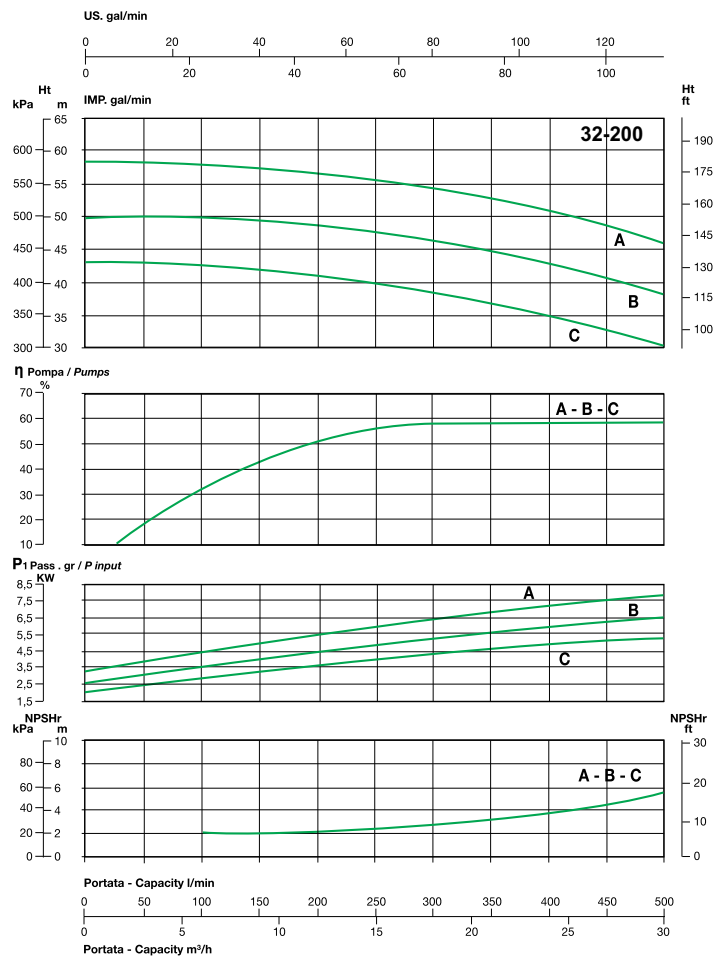
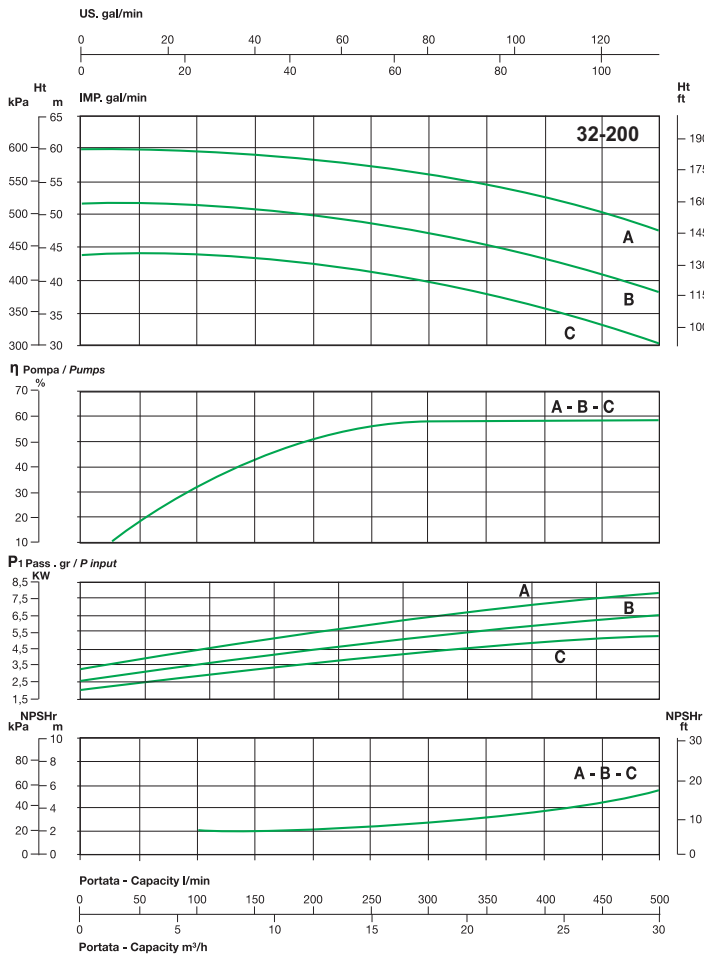
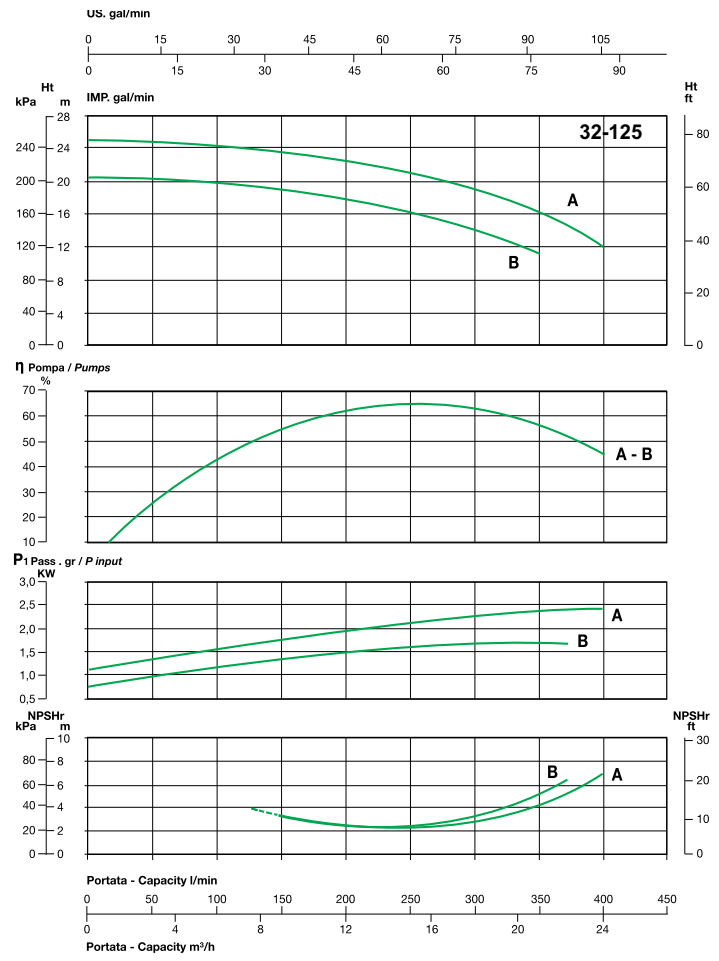
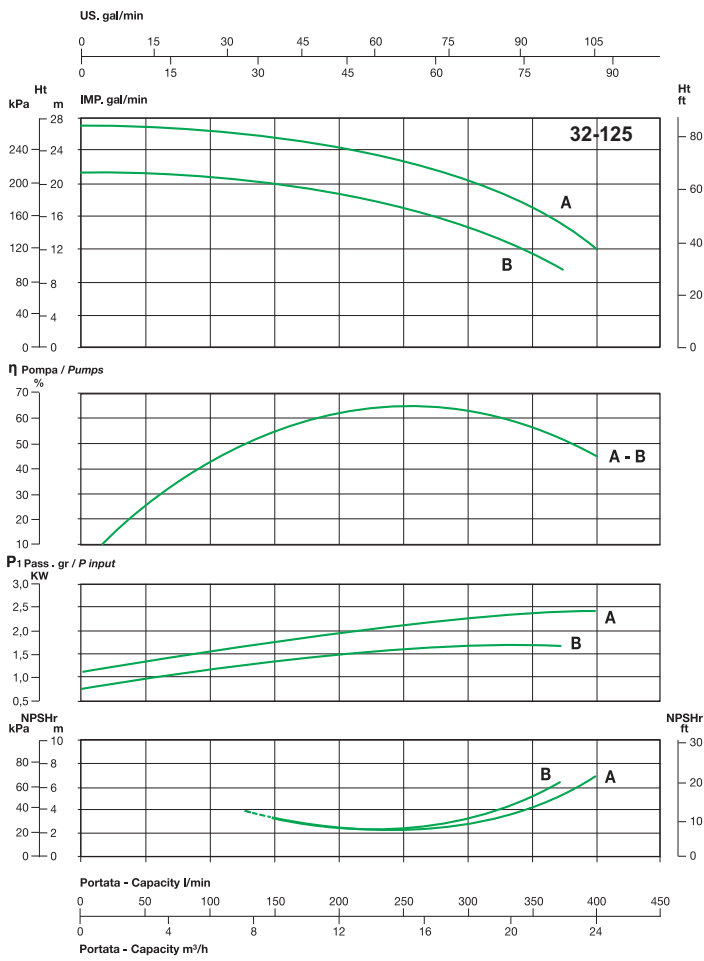

min⁻¹ ~ 2900

min⁻¹ ~ 3400

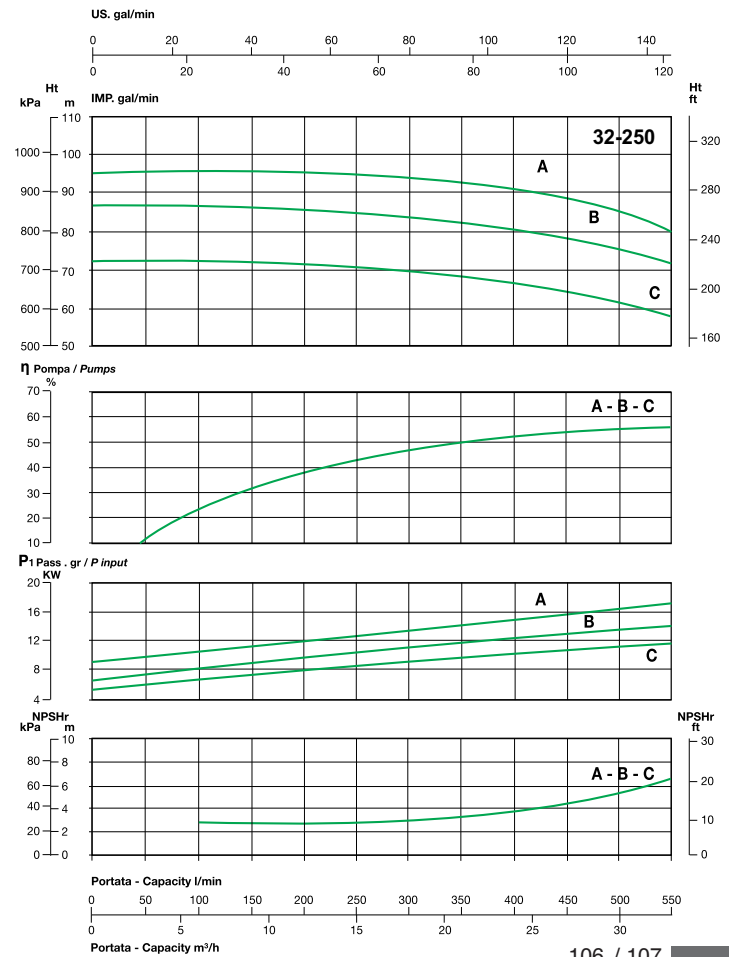
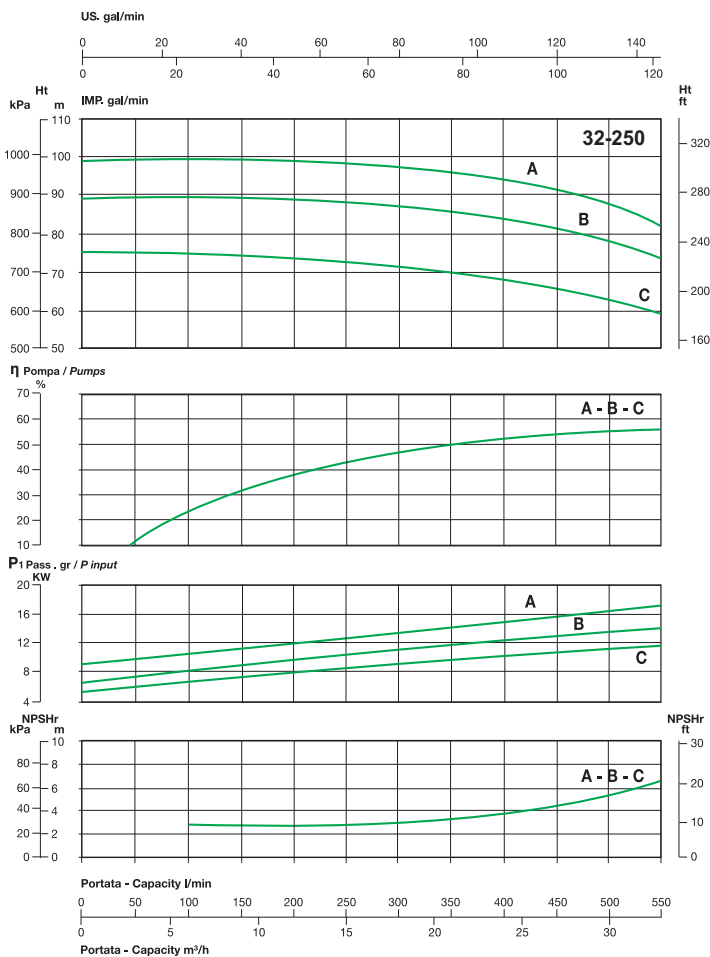
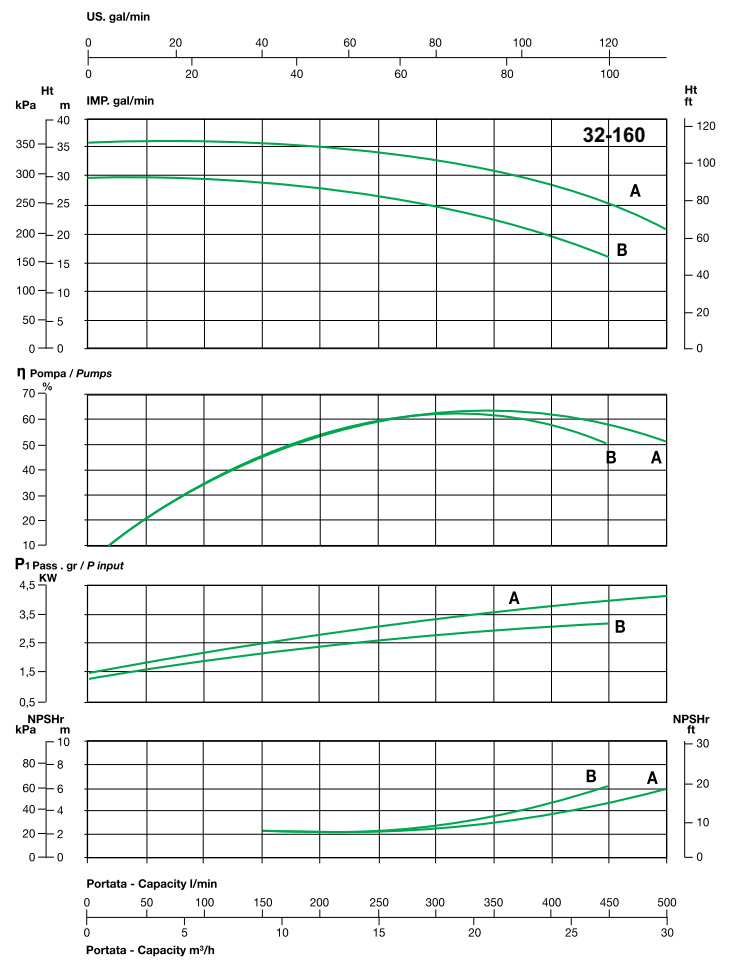
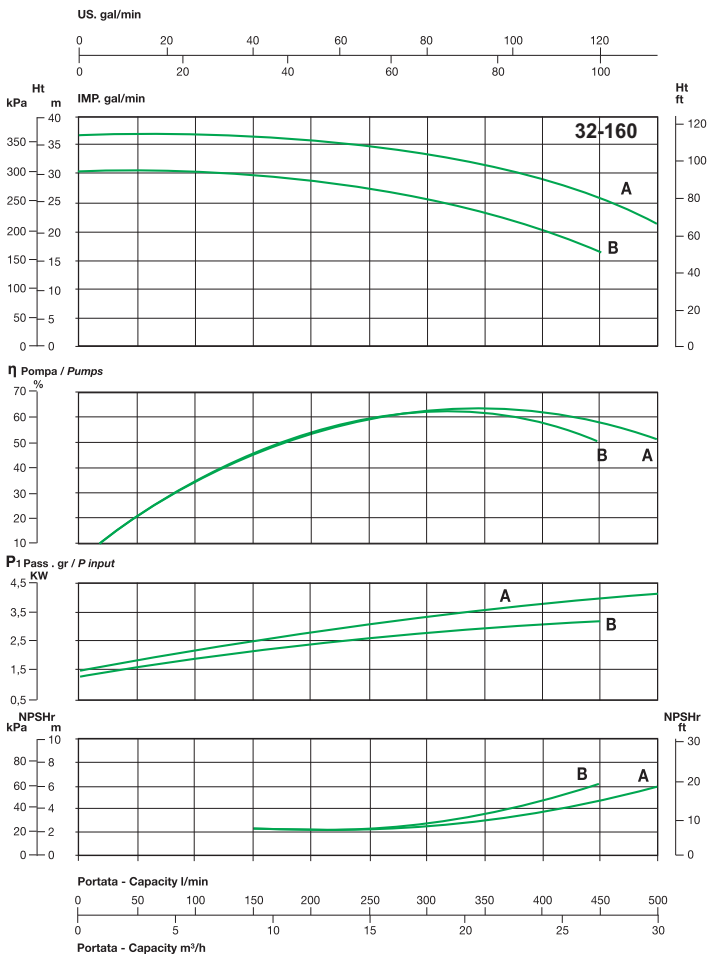

min⁻¹ ~ 2900

min⁻¹ ~ 3400

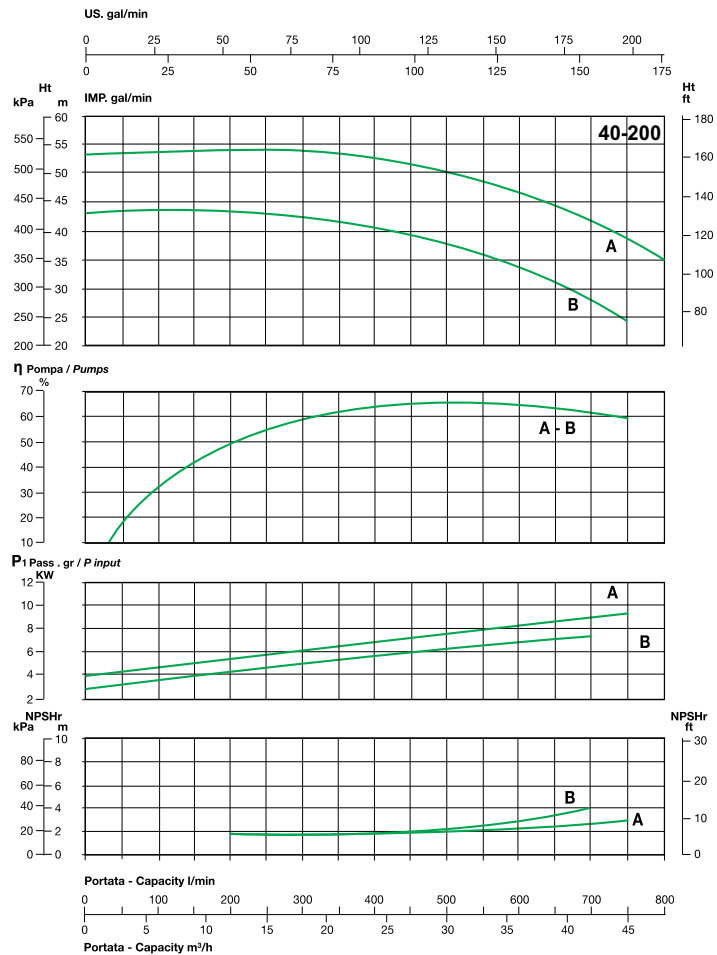
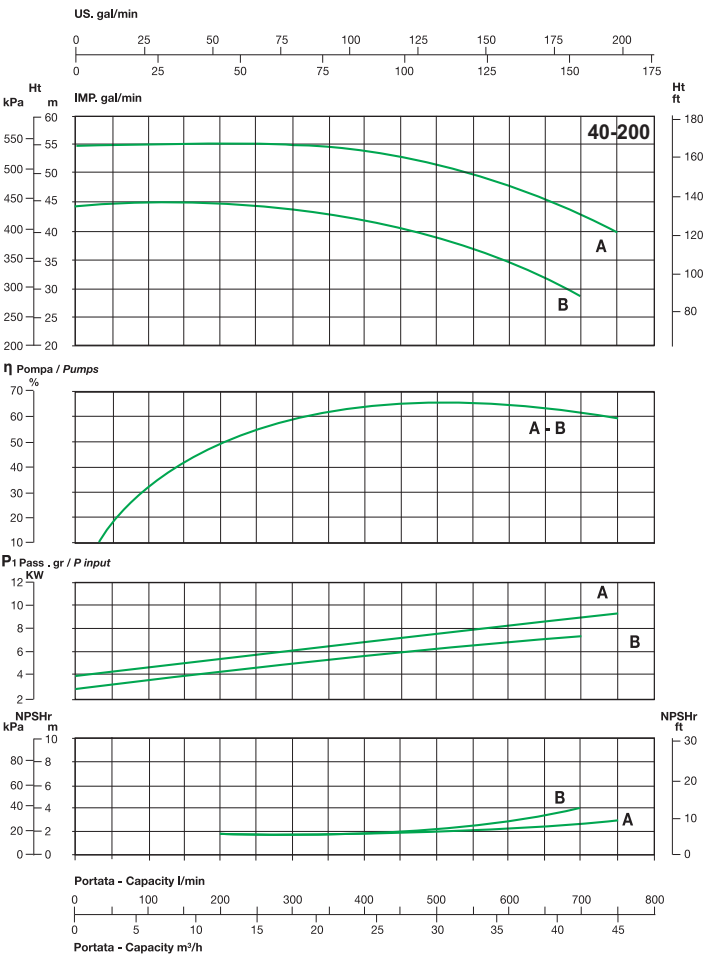
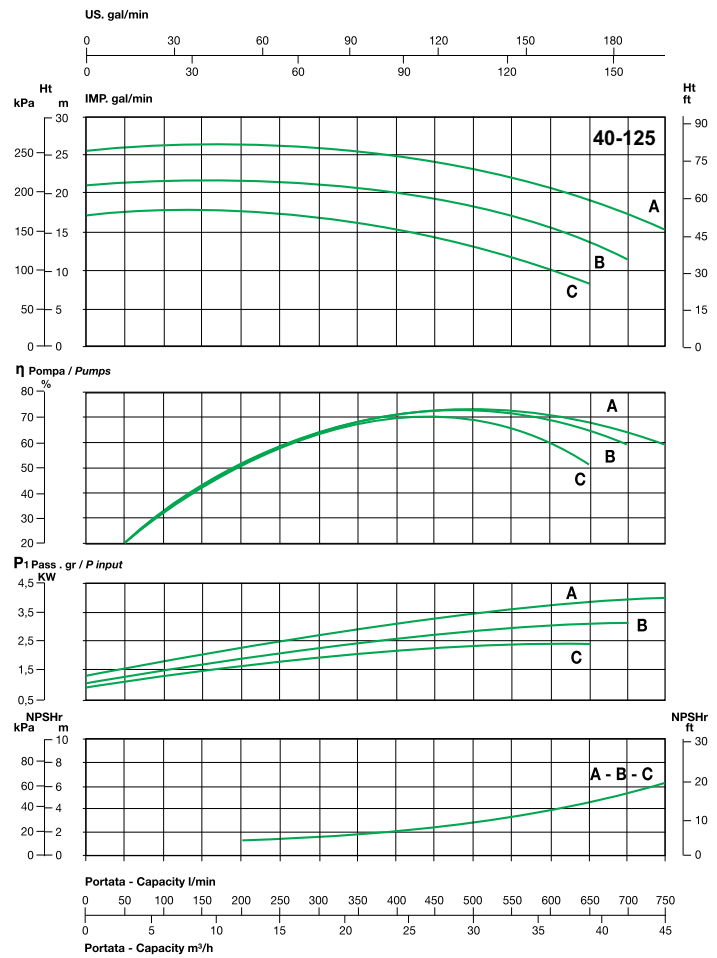
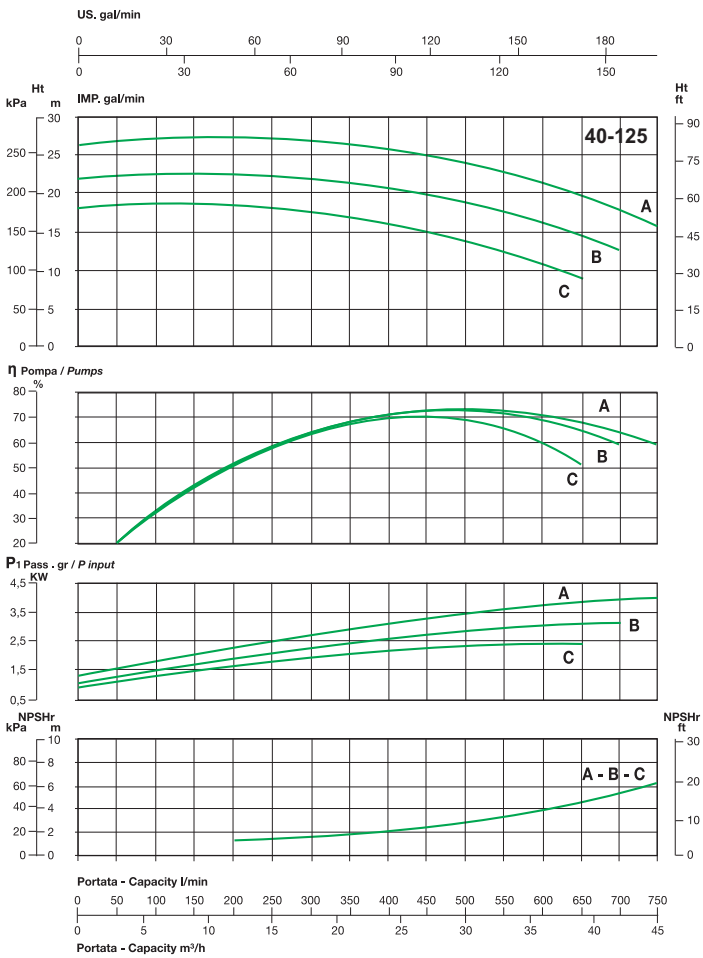

min⁻¹ ~ 2900

min⁻¹ ~ 3400

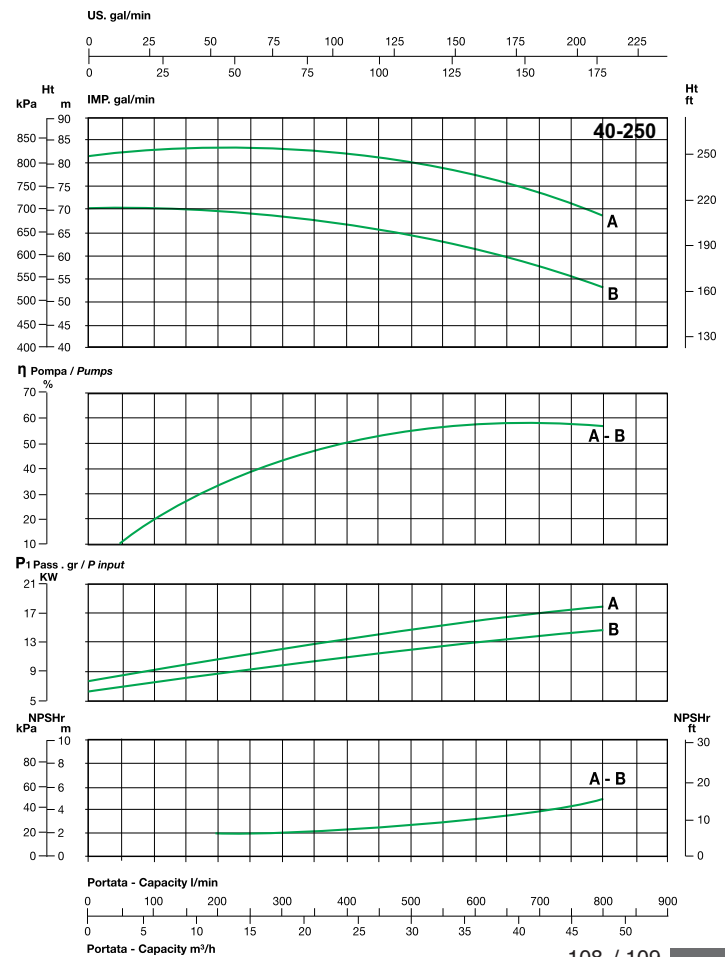
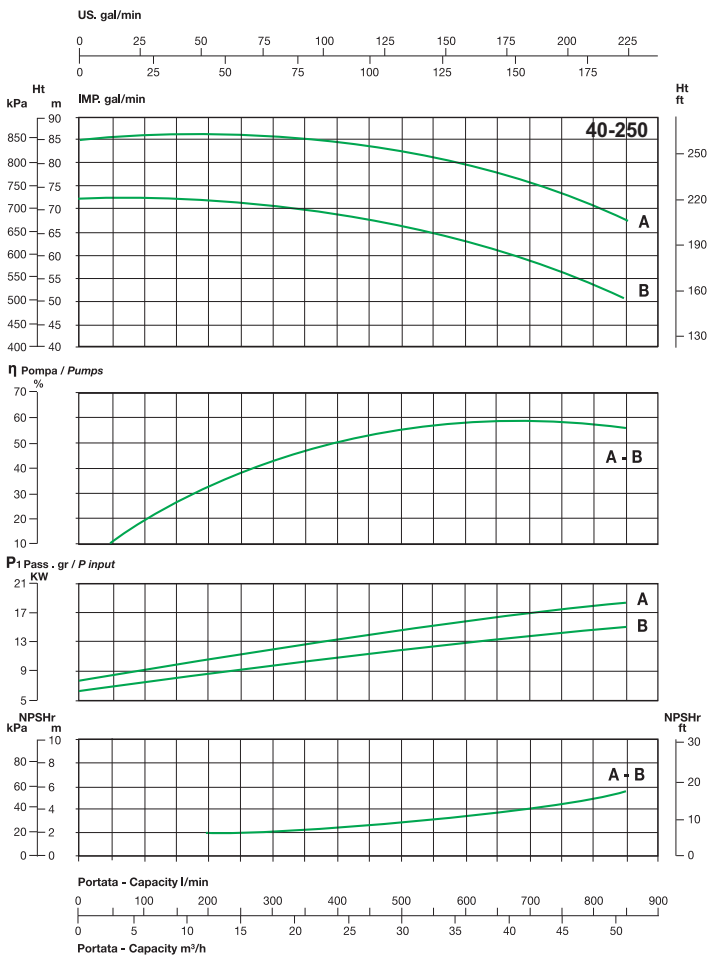
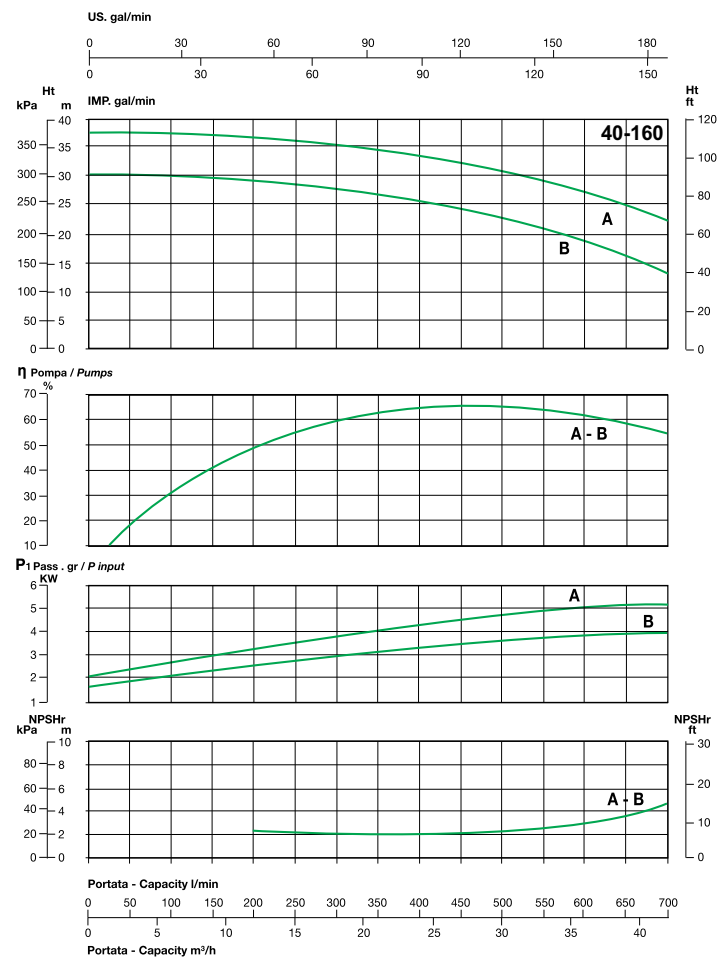
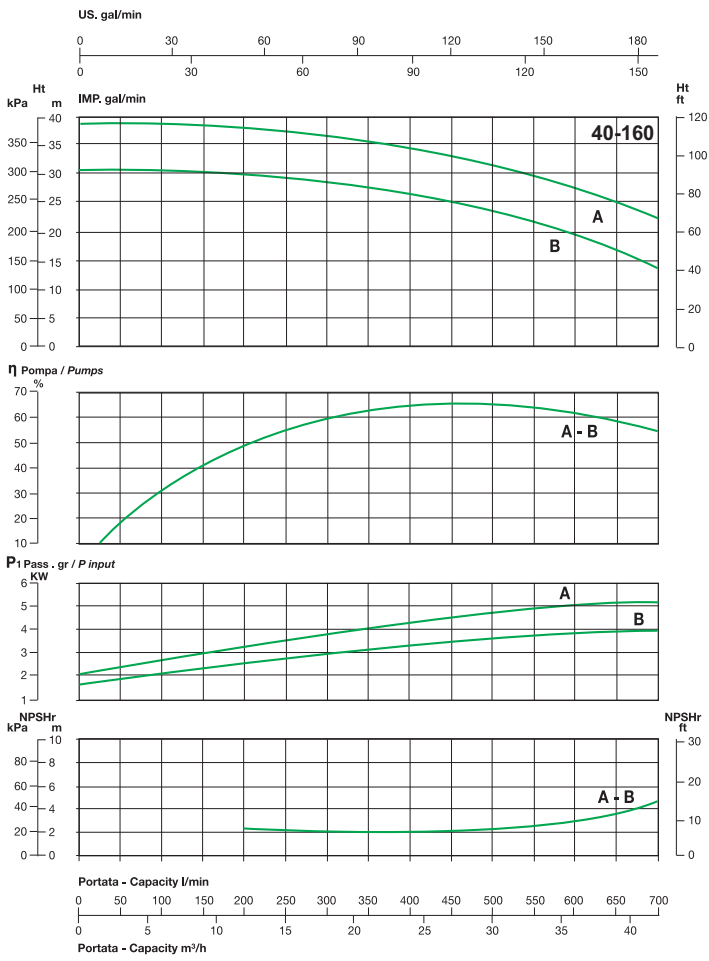

min⁻¹ ~ 2900

min⁻¹ ~ 3400

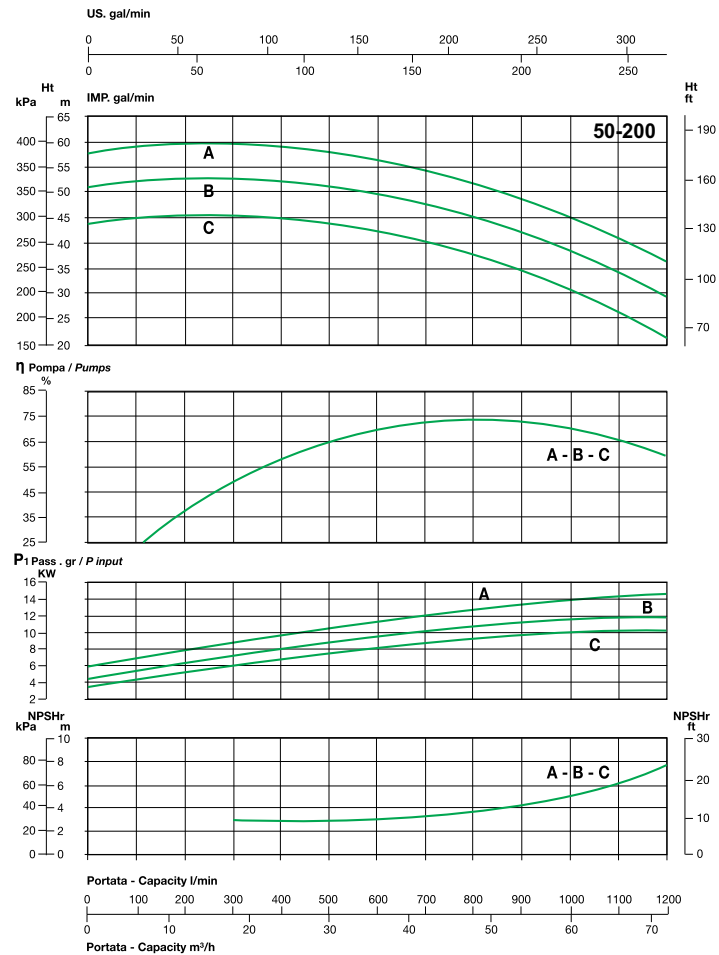
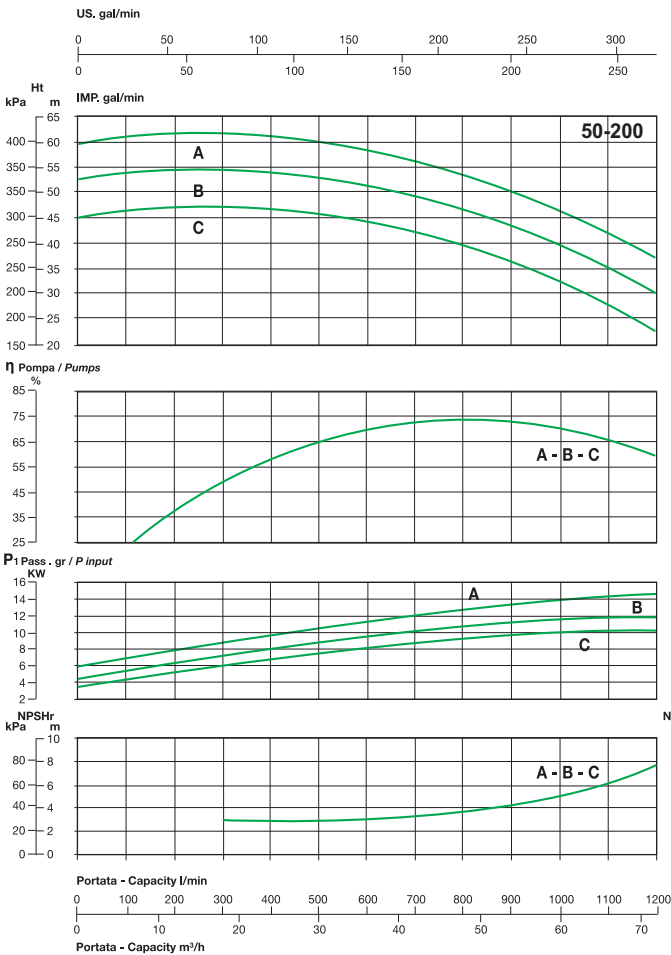
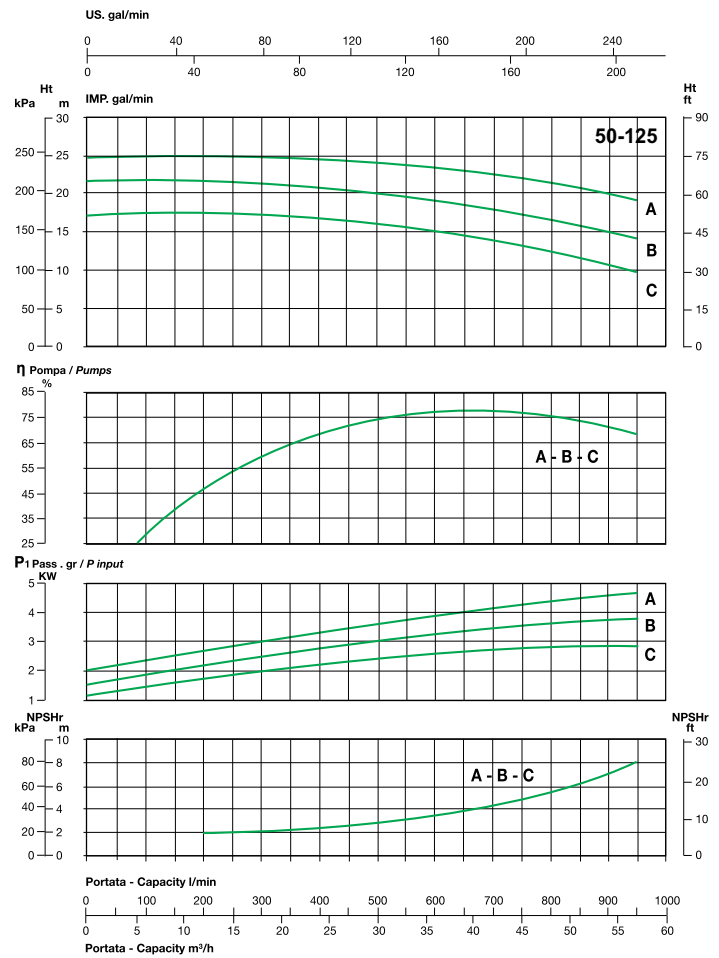
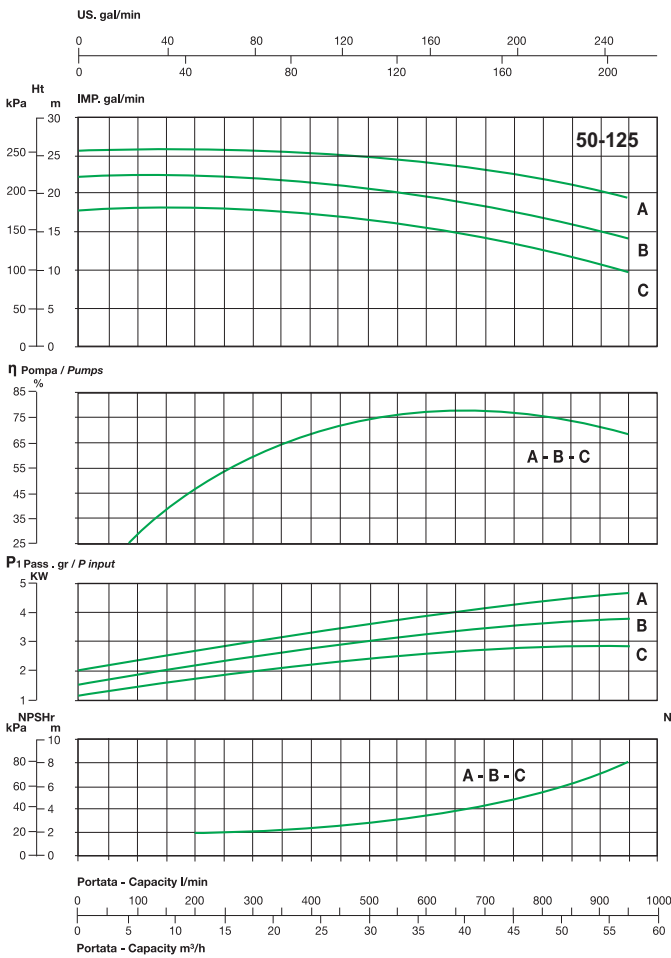

min⁻¹ ~ 2900

min⁻¹ ~ 3400

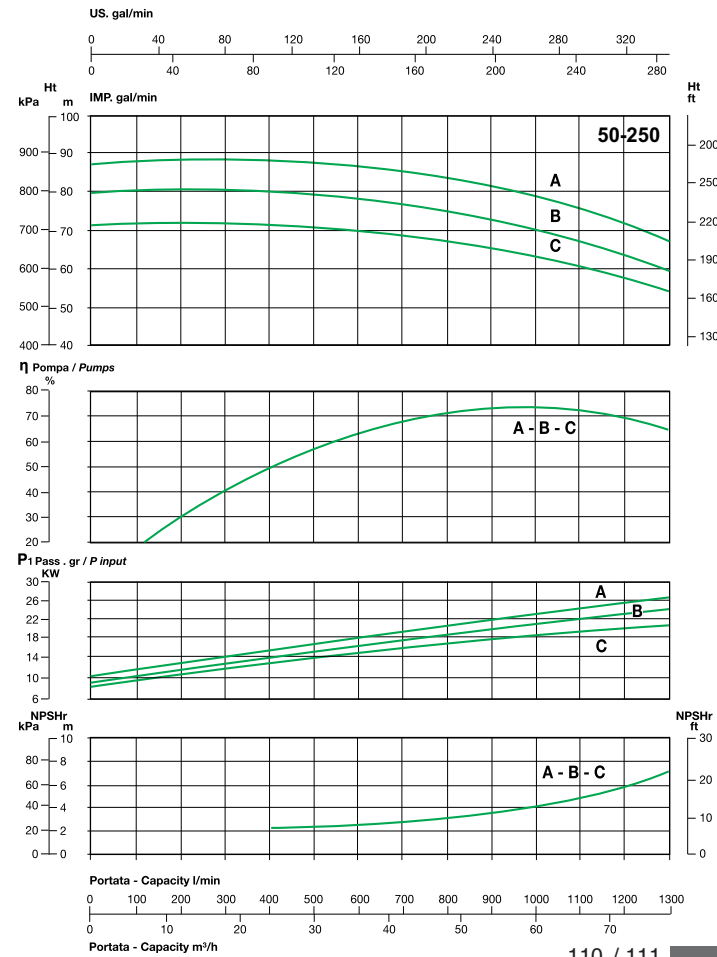
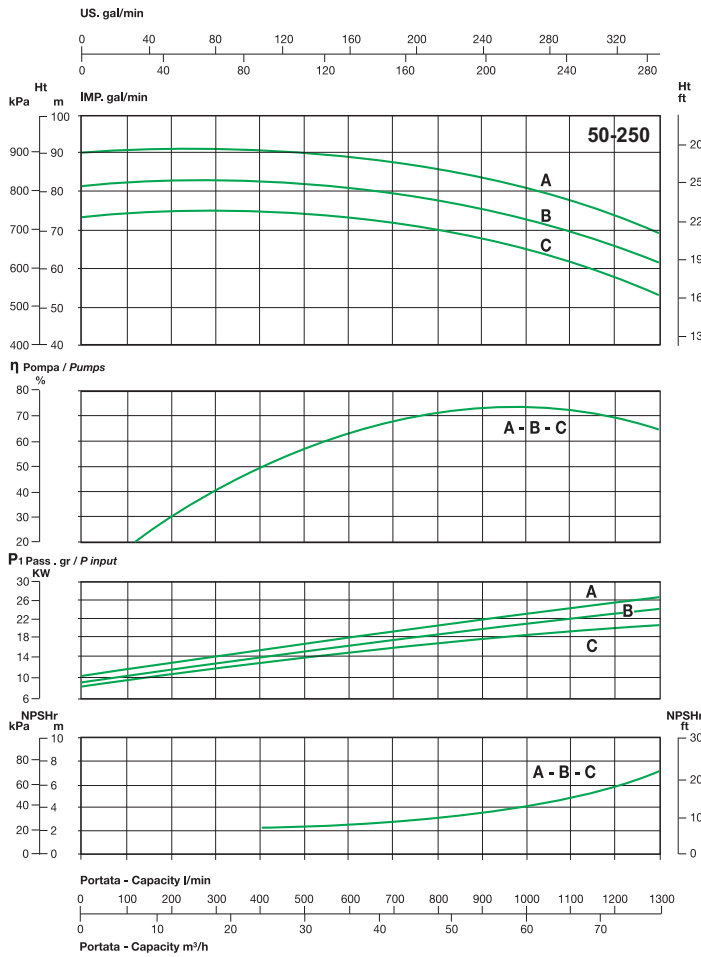
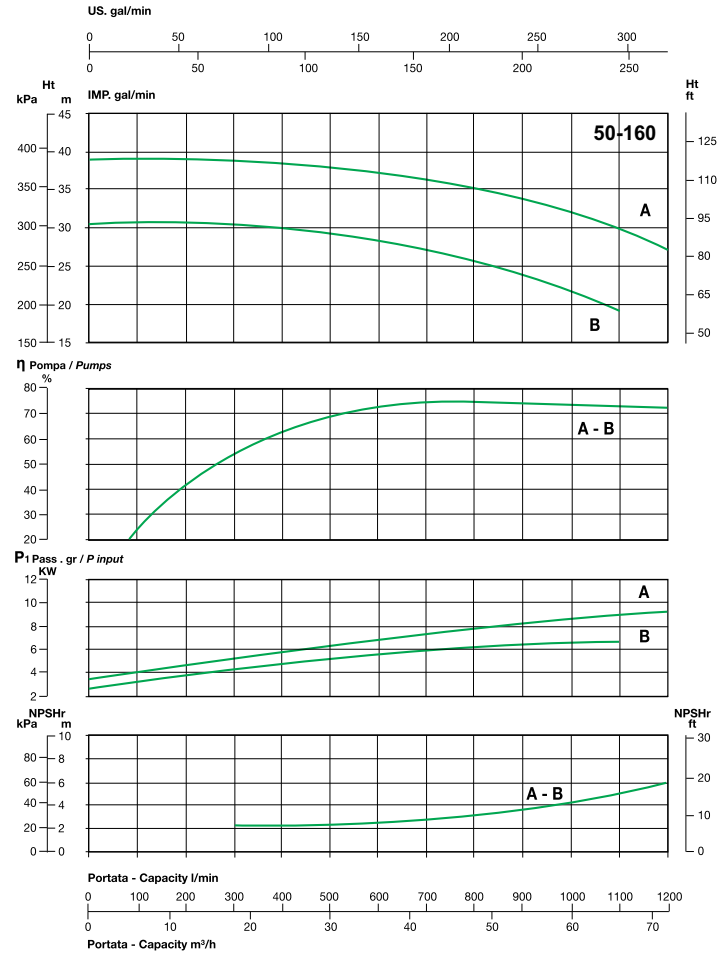
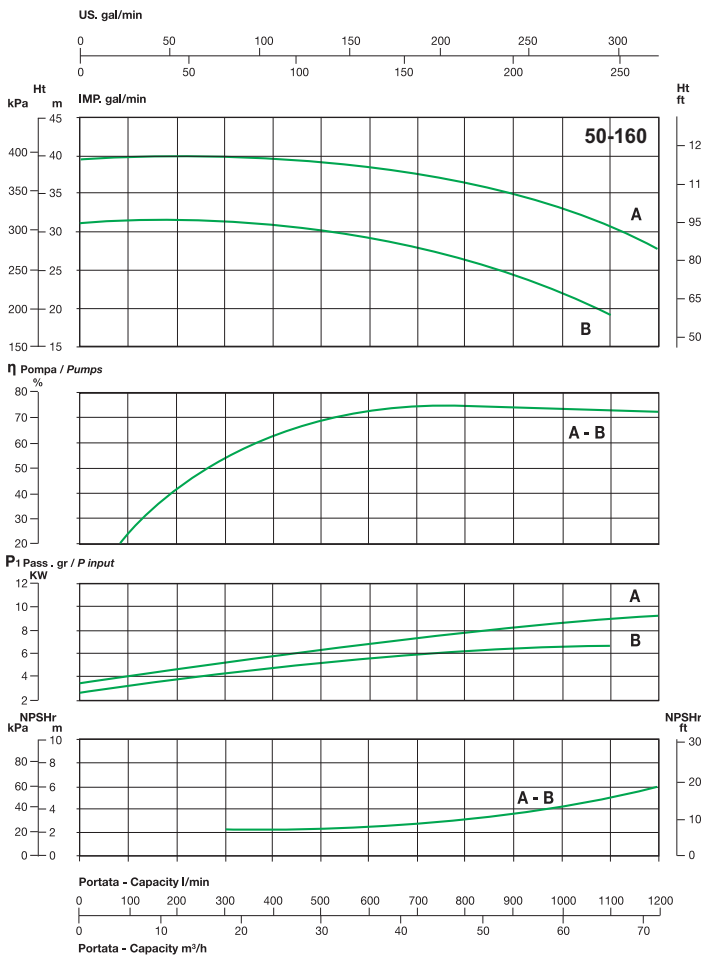

min⁻¹ ~ 2900

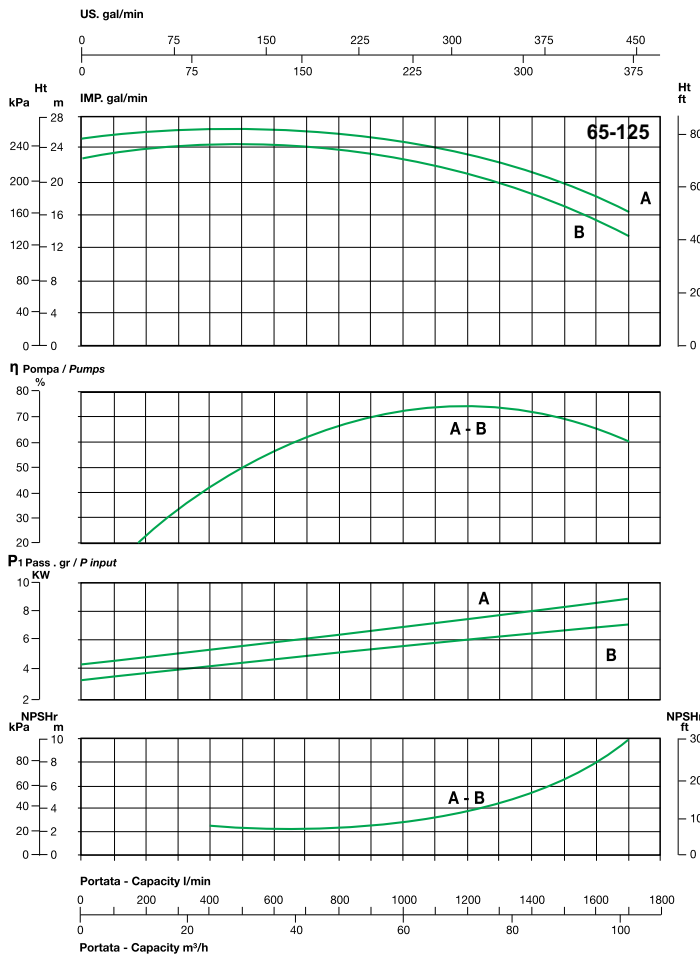

min⁻¹ ~ 3400

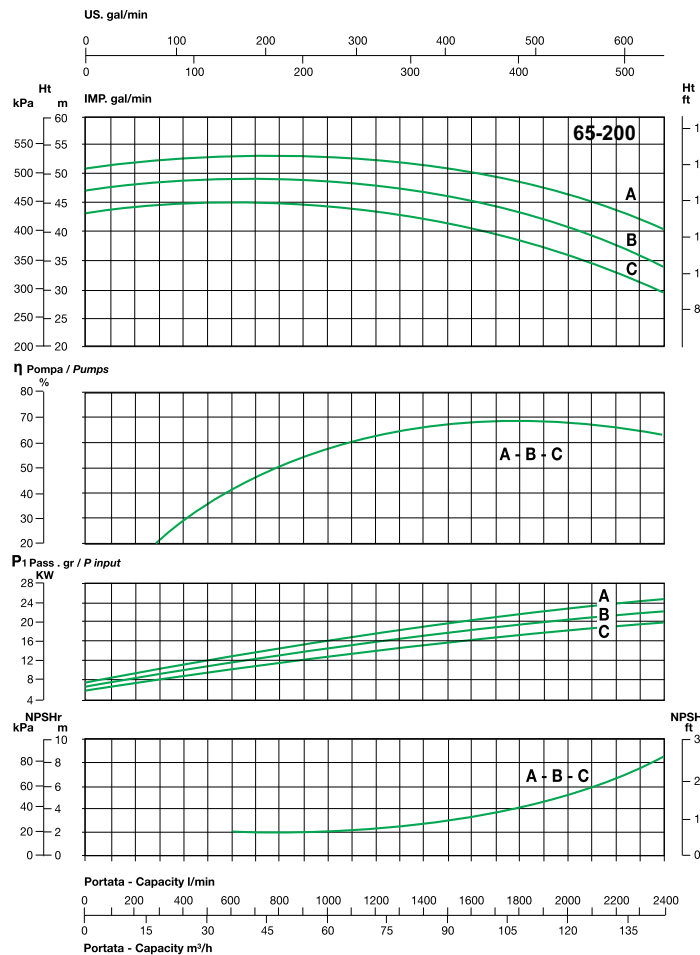
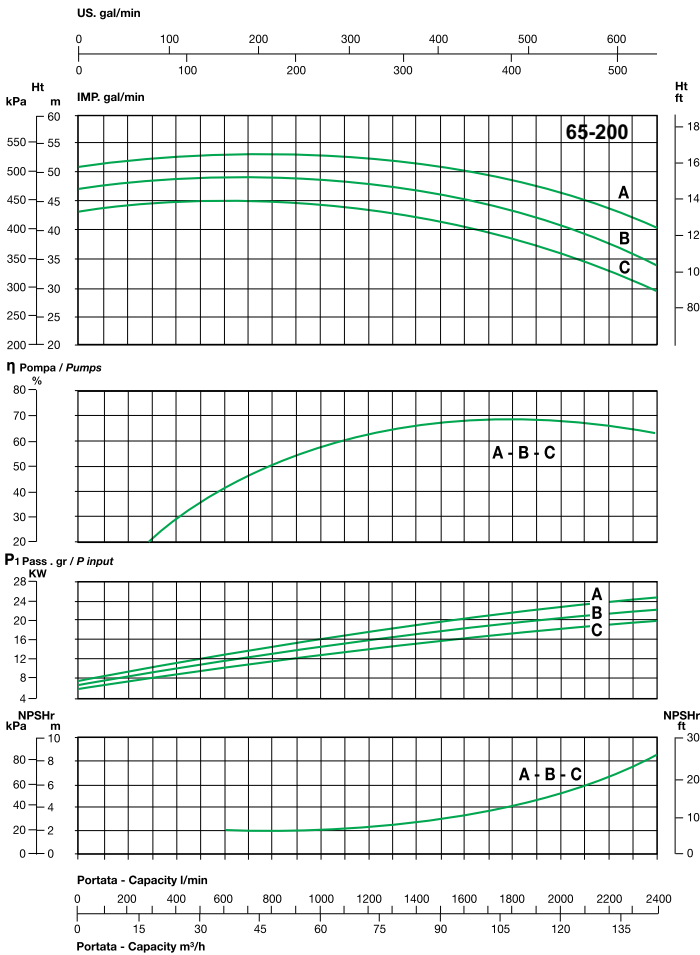
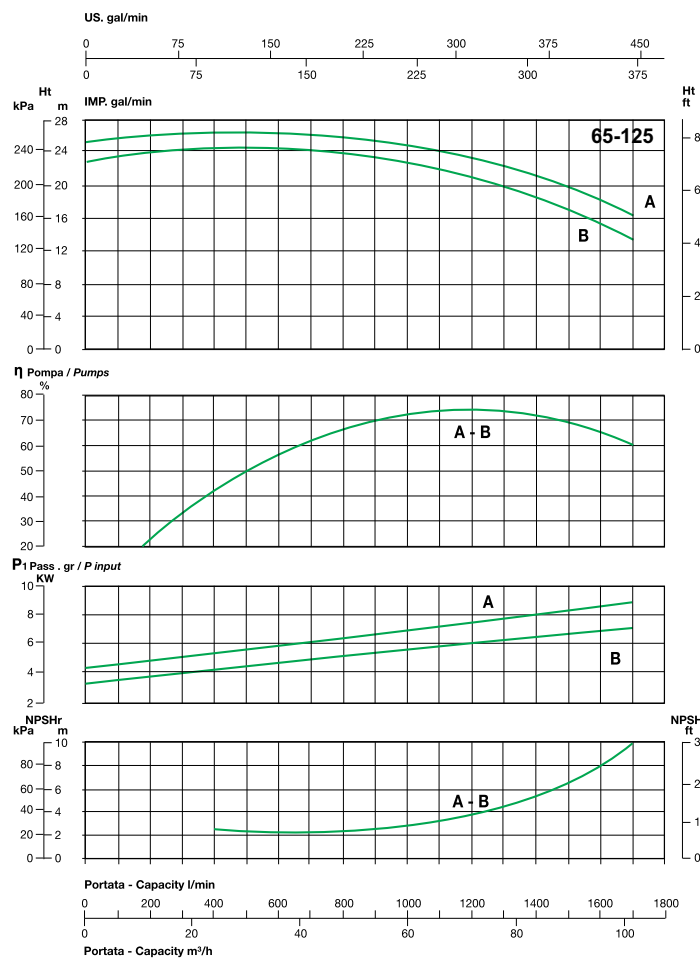

min⁻¹ ~ 2900

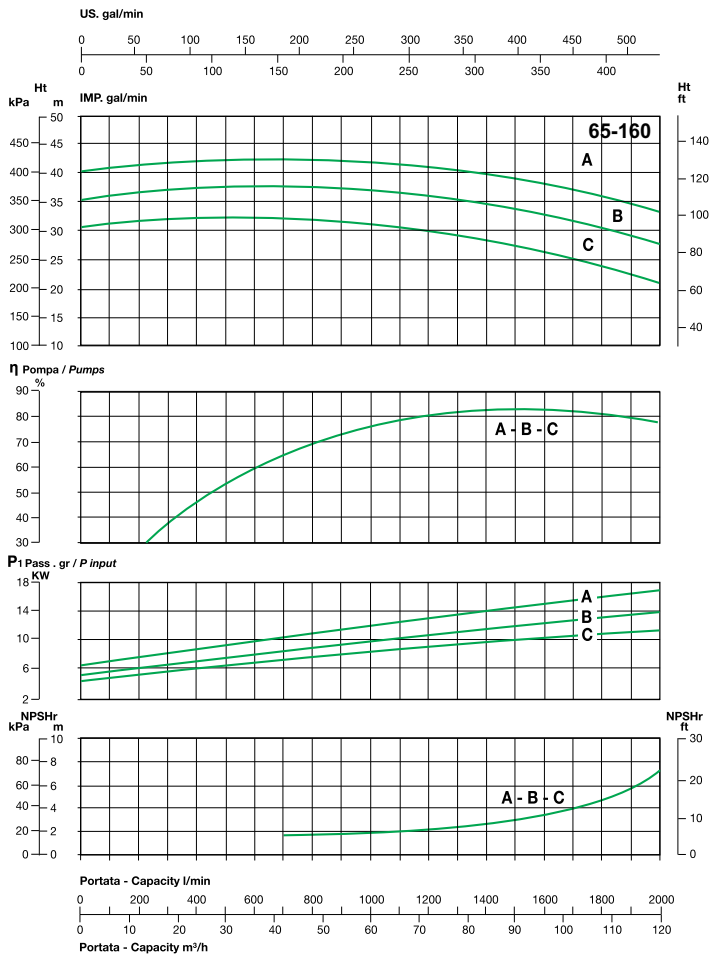

min⁻¹ ~ 3400

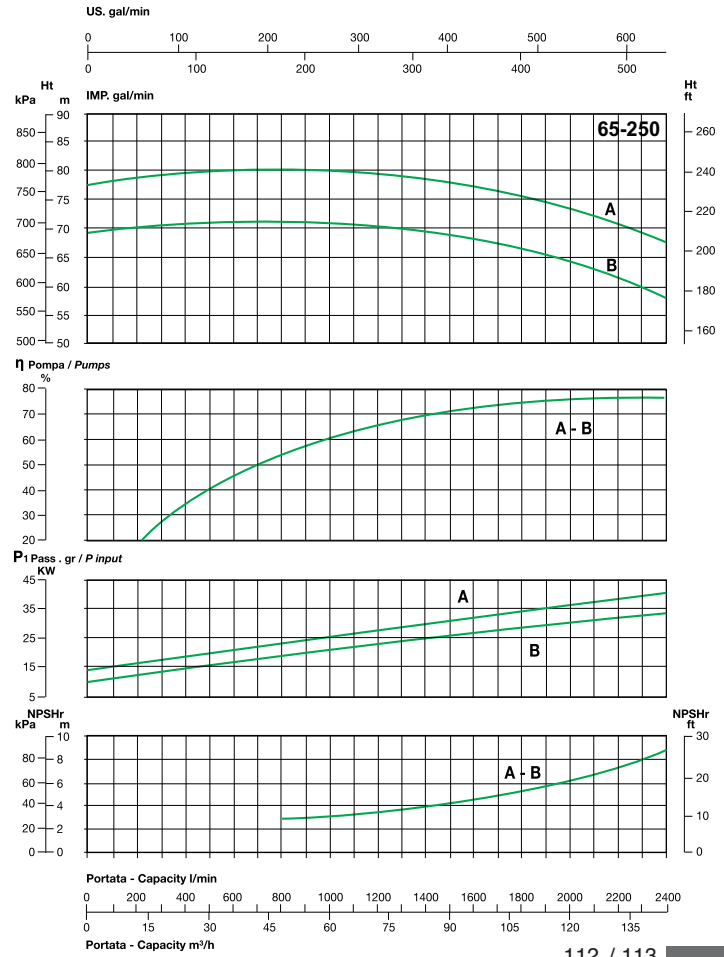
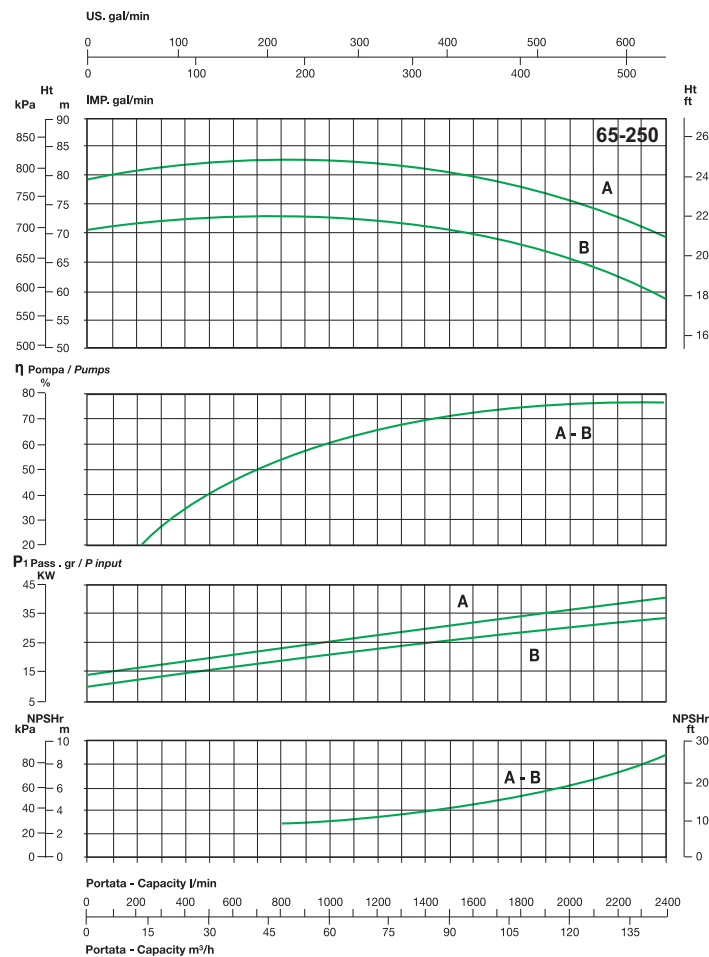
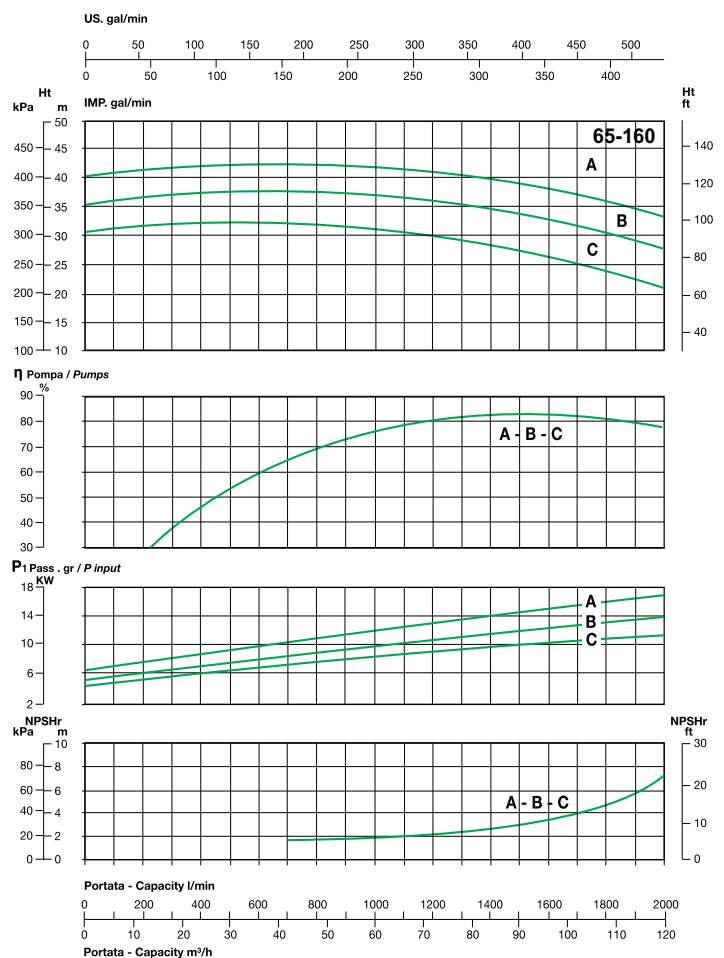

min⁻¹ ~ 2900

min⁻¹ ~ 3400

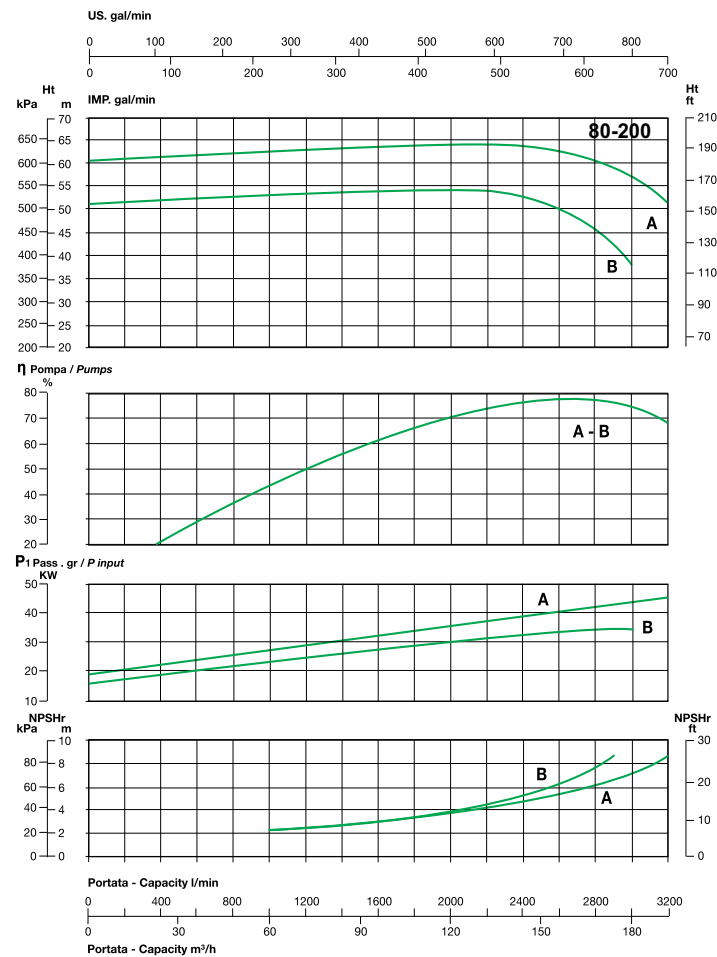
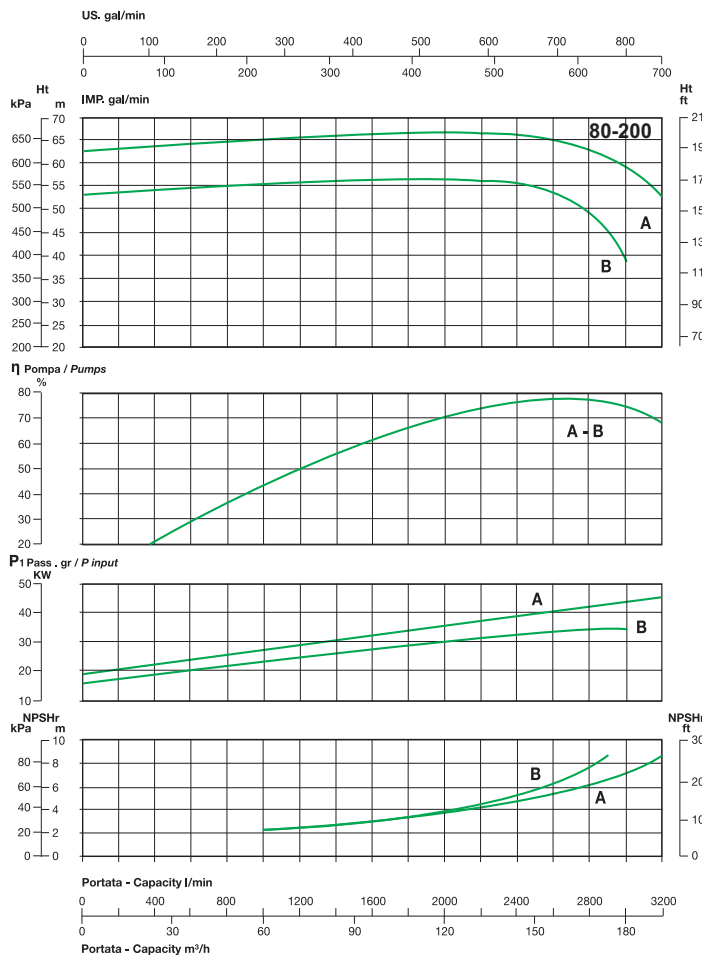
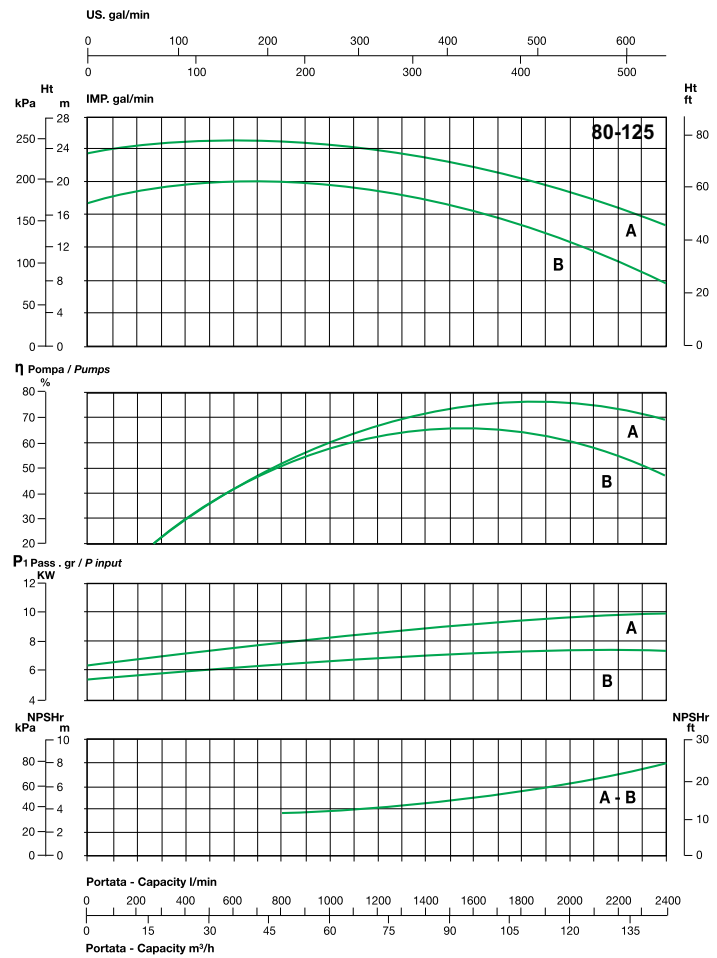
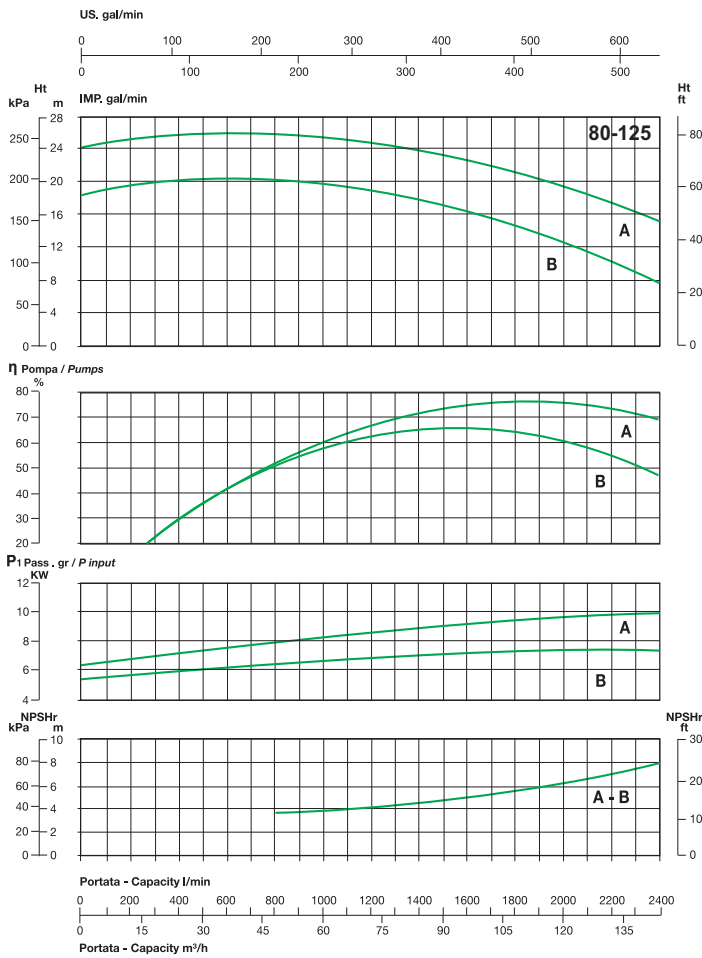

min⁻¹ ~ 2900

min⁻¹ ~ 3400

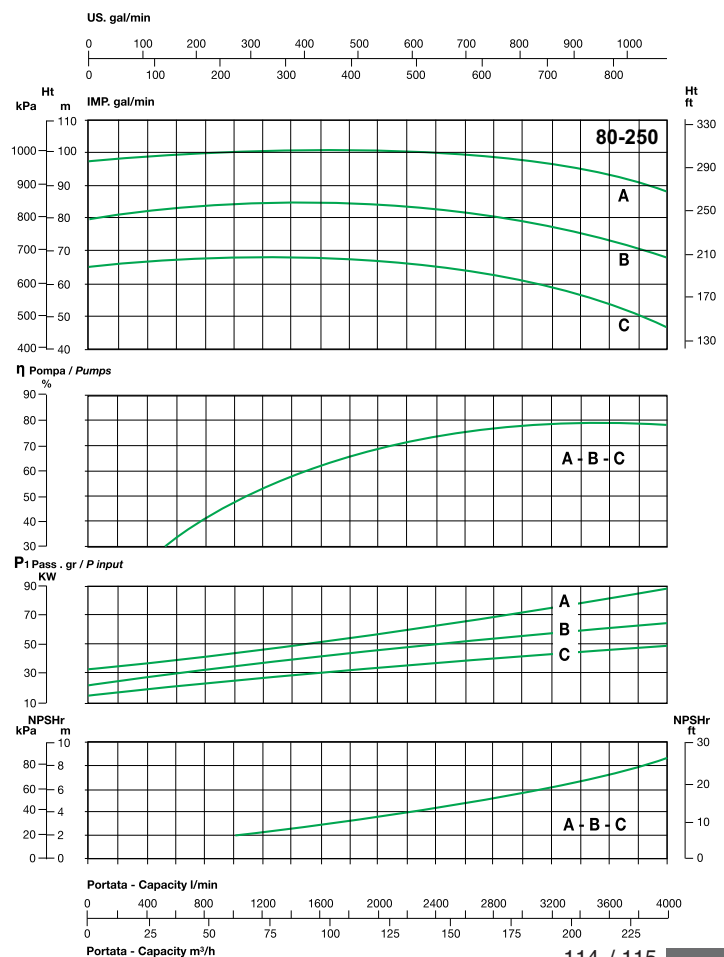
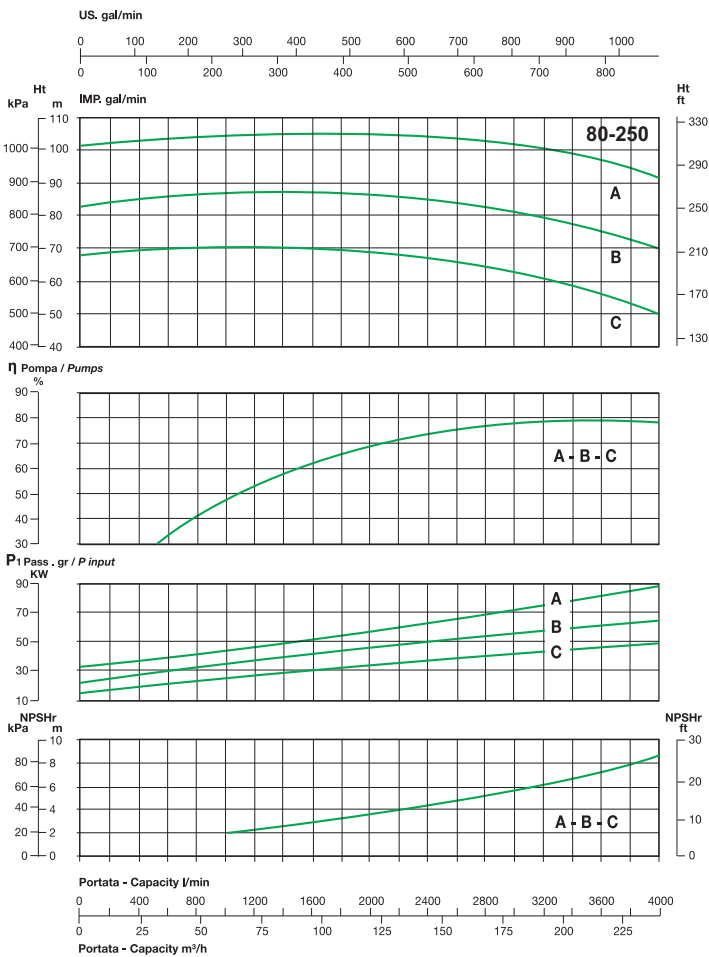
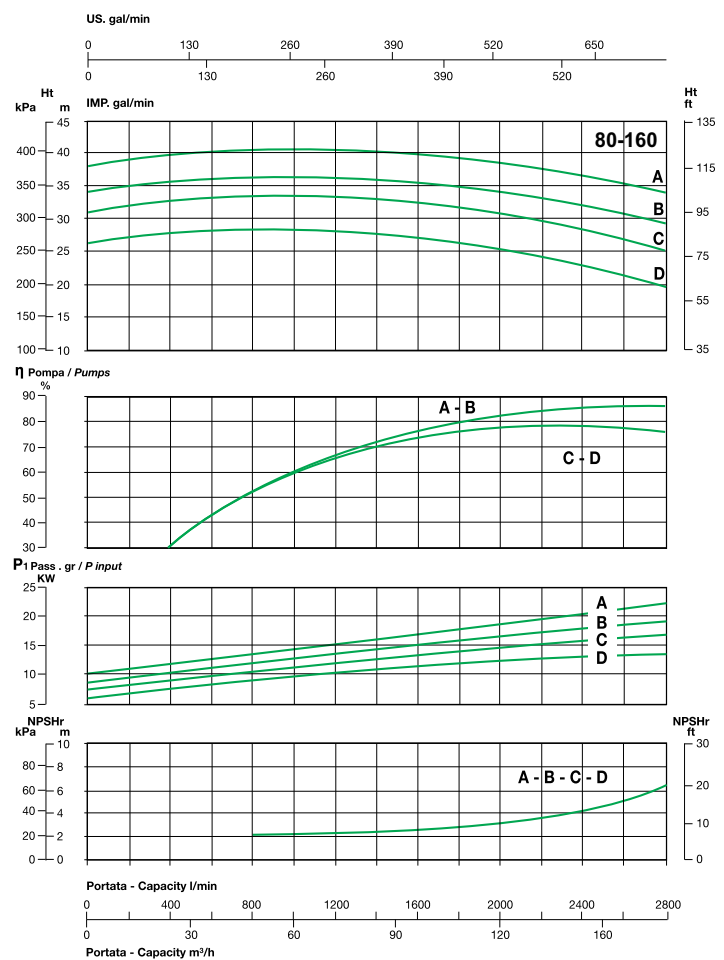
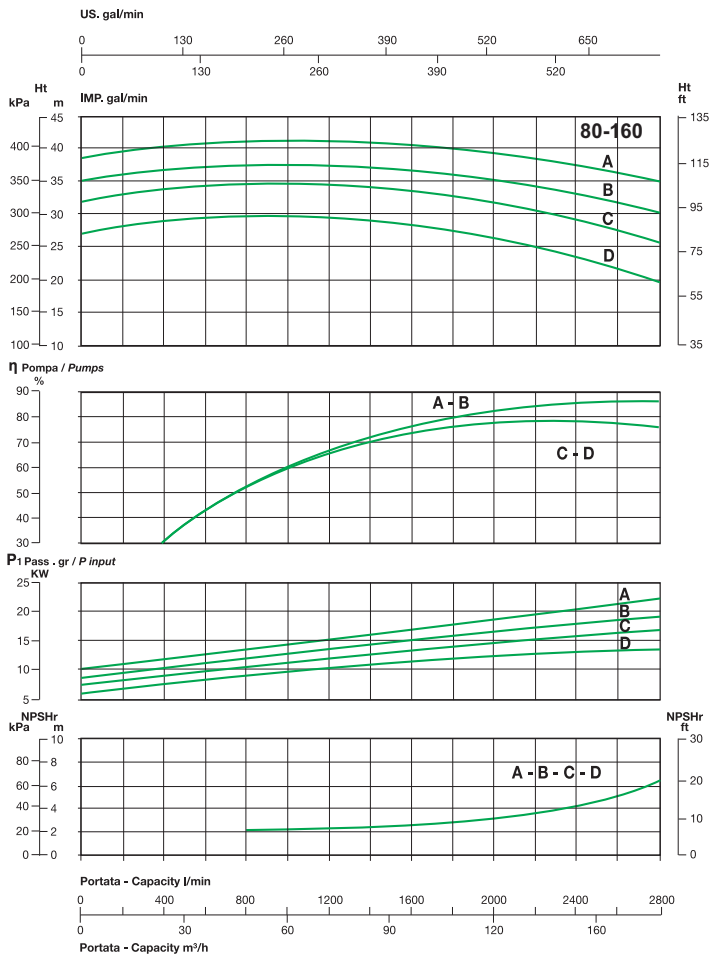

"BSN"



NOMENCLATURA PARTI DI RICAMBIO
SPARE PARTS LIST
NOMENCLATURE PIÈCES DE RECHANGE
NOMENCLATURA REPUESTOS

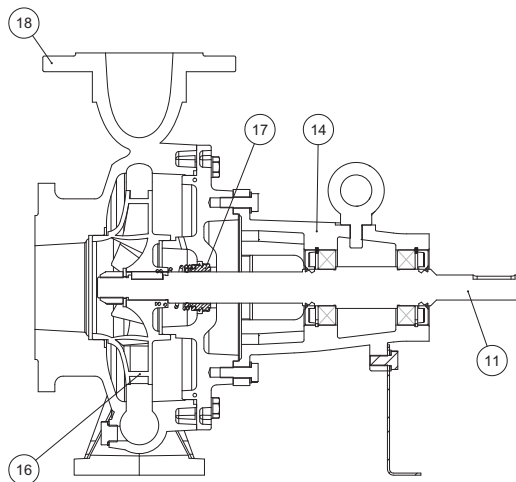

- 11** Albero con rotore – Pump shaft + rotor
Arbre + rotor – Eje rotor
- 14** Supporto mandata – Outlet bracket
Support envoyée – Soporte entrega
- 16** Girante – Impeller
Turbine – Impulsor
- 17** Tenuta meccanica – Mechanical seal
Garniture mécanique – Cierre mecánico
- 18** Corpo pompa – Pump body
Corp de pompe – Cuerpo bomba

POMPE CENTRIFUGHE NORMALIZZATE CON GIUNTO ELASTICO E MOTORE NORMALIZZATO

Le pompe centrifughe con giunto della serie "BSN" sono costruite in accordo con le normative UNI EN 733 (DIN 24255). Sono state progettate per il pompaggio di liquidi puliti, senza parti abrasive, senza corpi solidi in sospensione, non esplosivi o aggressivi per i materiali della pompa

- Temperatura max. del liquido fino a 35 °C per uso domestico (CEI EN 60335-2-41) o 90 °C per altri usi e temperatura ambiente fino a 40 °C.
- Portate fino a 240 m³/h.
- Prevalenze fino a 100 m.

CARATTERISTICHE COSTRUTTIVE

- Corpo pompa: ghisa G20 con trattamento anticorrosione
- Supporto motore: ghisa G20 con trattamento anticorrosione
- Bocche aspirazione/mandata: a norme DIN 2532
- Girante: ghisa G20 con trattamento anticorrosione
- Controflange filettate: acciaio zincato complete di guarnizioni in EPDM
- Albero pompa: acciaio inox Aisi 304
- Tenuta meccanica: carbone-ceramica

NORMALIZED CENTRIFUGAL PUMPS WITH ELASTIC COUPLING AND STANDARD MOTOR

The pumps with shaft of the series "BSN" are manufactured according to DIN 24255 (UNI EN 733) standards.

They have been designed to pump clean liquids, without abrasives and suspended solids, non-explosive or aggressive for the pump's materials.

- Liquid temperature not higher than 35 °C for domestic use (CEI EN 60335-2-41) or 90 °C for other use, while the ambient temperature must not be higher than 40 °C
- Flow rates up to 240 m³/h.
- Heads up to 100 m.

TECHNICAL FEATURES

- Pump body: cast iron G20 with anti-corrosive coating
- Motor bracket: cast iron G20 with anti-corrosive coating
- Orifices in/outlet: DIN 2532 standards
- Impeller: cast iron G20 with anti-corrosive coating
- Threaded counter flanges: galvanized steel complete with EPDM gaskets
- Pump shaft: stainless steel Aisi 304
- Mechanical seal: carbon-ceramics

POMPE CENTRIFUGES NORMALISÉES À ACCOUPLEMENT ELASTIQUE ET MOTEUR NORMALISÉ

Les pompes centrifuges à accouplement de la série "BSN" sont construites en accord avec les réglementations UNI EN 733 (DIN 24255). Elles ont été conçues pour le pompage de liquides propres, sans parties abrasives, sans corps liquides en suspension, non explosifs ou agressifs pour les matériaux de la pompe

- Température max. du liquide jusqu'à 35 °C pour utilisation domestique (CEI EN 60335-2-41) ou 90 °C pour d'autres utilisations et température ambiante jusqu'à 40 °C.
- Plage d'utilisation jusqu'à 240 m³/h.
- Hauteur manométrique jusqu'à 100 m.

CARACTERISTIQUES DE CONSTRUCTION

- Corps de pompe : En fonte G20 avec traitement anti-corrosion
- Lanterne: En fonte G20 avec traitement anti-corrosion
- Aspiration/refoulement : norme DIN 2532
- Turbine: En fonte G20 avec traitement anti-corrosion
- Contre brides filetéés: en acier galvanisé avec joints en EPDM
- Abre de pompe: acier inox Aisi 304
- Garniture mécanique: Carbone dur - Céramique

BOMBAS CENTRÍFUGAS NORMALIZADAS CON ACOPLAMIENTO ELASTICO Y MOTOR NORMALIZADO

Las bombas centrifugas con acoplamiento de la serie "BSN" han sido construidas conforme las normativas UNI EN 733 (DIN 24255). Han sido proyectadas para bombear líquidos limpios, sin partes abrasivas, sin cuerpos sólidos en suspensión, que no sean explosivos ni agresivos para los materiales de la bomba.

- Temperatura max. del líquido hasta 35 °C para uso doméstico (CEI EN 60335-2-41) o 90 °C para otros usos y temperatura ambiente hasta 40 °C.
- Caudal hasta 240 m³/h.
- Alturas hasta 100 m.

CARACTERÍSTICAS DE CONSTRUCCIÓN

- Cuerpo de bomba: Fundición gris G20 con tratamiento contra-corrosión
- Soporte: Fundición gris G20 con tratamiento contra-corrosión
- Bocas de entrada y salida : normalizadas DIN 2532
- Rodete: Fundición gris G20 con tratamiento contra-corrosión
- Contra bridas roscadas: de acero galvanizado con juntas de EPDM
- Eje de la bomba: de acero Inox AISI304
- Cierre mecánico: De cerámica y grafito

50 Hz - min⁻¹ ~ 2900 - 2 poli

TIPO TYPE Trifase Three-phase	Potenza nominale Nominal power		Portata - Capacity																DNA mm	DNM mm						
			Q [m ³ /h] Q [l/1']																							
			0	3	6	9	12	15	18	21	24	27	30	33	36	39	42	45			48	57	60	66	72	78
			Prevalenza (m C.A.) Total head (m W.C.)																							
[kW] [HP]			H [m]																							
BSN 32 125B 2	1,1	1,5	21,5	21,0	20,5	20,0	18,5	17	14,5	12														50	32	
BSN 32 125A 2	1,5	2	26,0	26,5	26,5	26,0	24,0	22,5	20	16,5	12,5													50	32	
BSN 32 160B 2	2,2	3	30,5	30,5	30,0	29,5	28,5	27,5	25,5	23	20,5	17												50	32	
BSN 32 160A 2	3	4	37,0	37,5	37,5	37,0	36,5	34,5	33	31	28	25	22											50	32	
BSN 32 200C 2	4	5,5	44,0	44,5	44,0	43,0	42,0	41,0	39,0	37,5	35	32,5	30											50	32	
BSN 32 200B 2	5,5	7,5	51,0	51,5	51,0	50,5	50,0	48,0	46,5	45,0	42,5	40	38											50	32	
BSN 32 200A 2	7,5	10	59,5	59,5	59,5	59,0	58,0	57,5	56,0	54,5	52,5	50	47,5											50	32	
BSN 32 250C 2	9,2	12,5	75	75	75	74,5	74	73	72	70	68	65,5	62,5	60										50	32	
BSN 32 250B 2	11	15	89,5	89,5	89,5	89	88,5	88	87	85,5	83	81	77,5	74										50	32	
BSN 32 250A 2	15	20	98	98	98	98	98	98	97,5	96	94	92	87,5	83										50	32	
BSN 40 125C 2	1,5	2	17,5	17,8	18	19	18,3	18	17,5	17	16	15	13,5	12,5	11	8,5								65	40	
BSN 40 125B 2	2,2	3	22	22,3	22,5	22,5	22,5	22,3	22	21,5	20,5	19,5	18,5	18	16,5	14,5	12,5							65	40	
BSN 40 125A 2	3	4	26,5	27	27,5	27,5	27,5	27	26,5	26,3	25,5	25	23,7	23	21,5	19,5	17,5	16						65	40	
BSN 40 160B 2	3	4	31	31,2	31,5	31	30	29,8	28,5	27,5	27	25	23,5	22	19,5	17	14,5							65	40	
BSN 40 160A 2	4	5,5	38,5	39	38,8	38,5	37,8	37,5	36,5	35,5	34,5	33	32	29,5	27,5	25	23							65	40	
BSN 40 200B 2	5,5	7,5	44	44,5	44,8	45	44,5	44,3	43,5	43	42	40,5	39	37	34,5	32	29	25						65	40	
BSN 40 200A 2	7,5	10	54,5	54,8	55	55	55	55	54,8	54,5	53,8	53	51,5	49,5	48	45,5	43	40	36,5					65	40	
BSN 40 250B 2	11	15	72	72	72,5	72,3	72	71	70,5	70	69	68	66,5	65	63,5	61,5	59	56	54,5					65	40	
BSN 40 250A 2	15	20	84,5	85	85,5	85,8	85,5	85,5	85,2	85	84,5	84	82,5	81	79,5	78	75,5	73,5	70,5					65	40	
BSN 50 125C 2	2,2	3	17,5	18	18	18	18	18	18	17,8	17,5	17	16,5	16	15,5	15	14	13,5	12,5	10				65	50	
BSN 50 125 B 2	3	4	22,5	22,5	22,5	22,5	22,5	22,5	22	21,8	21,5	21	20,5	20	19,5	19	18,5	17,5	17	14,5				65	50	
BSN 50 125A 2	4	5,5	25,5	25,8	26	26	26	25,8	25,5	25,5	25,3	25	24,5	24,5	24	23,5	23	22,5	22	19,5				65	50	
BSN 50 160B 2	5,5	7,5	31,5	32	32	32	32	32	31,8	31,5	31	30,5	30	29,7	29,5	28,5	28	27	26,5	23,5	22	19,5		65	50	
BSN 50 160A 2	7,5	10	39,5	40	40	40	40	40	40	40	39,8	39,5	39	38,5	38	37,7	37,5	37	36,5	34	33	31	28	65	50	
BSN 50 200C 2	9,2	12,5	45	46	46,5	46,7	47	47,3	47,5	47	46,5	46	45,5	45	44,5	43,5	42,5	41	40	34,5	32,5	28	23	65	50	
BSN 50 200B 2	11	15	52,5	53,5	54	54,5	54,5	54,5	54,5	54,3	54	53,8	53,5	52	51	50	49	47,5	46,5	42	39,5	35,5	30	65	50	
BSN 50 200A 2	15	20	59,5	60,5	61	61,5	61,5	61,5	61,3	61	60,5	60	59,5	58,5	57	56	55	53,5	48	46,5	42	37,5		65	50	
BSN 50 250C 2	15	20	73	73,5	74	74,5	75	75	75	75	75	74,8	74,5	73,5	72,5	72	71,5	71	70	67	65	62	58	54	65	50
BSN 50 250B 2	18,5	25	82	82,3	82,5	82,5	82,5	82,5	82,5	82,5	82,5	82,3	82	81,5	81	80	79,5	79	78	74	72,5	70	66,5	61,5	65	50
BSN 50 250A 2	22	30	89,5	90	90,5	90,8	91	91	91	90,8	90,5	90,2	90	89,5	89	88,5	88	87	86,5	83	80,5	78	74	69,5	65	50

CAMPO DELLE PRESTAZIONI / RANGE OF PERFORMANCES

50 Hz - min⁻¹ ~ 2900 - 2 poli

TIPO TYPE Trifase Three-phase	Potenza nominale Nominal power		Portata - Capacity																DNA mm	DNM mm							
			Q [m ³ /h] Q [l/1']																								
			0	12	24	30	36	42	48	54	60	66	72	78	84	96	102	120			132	144	156	168	180	192	240
			Prevalenza (m C.A.) Total head (m W.C.)																								
[kW] [HP]			H [m]																								
BSN 65 125B 2	5,5	7,5	23,5	24,5	25,0	25,0	25,0	24,5	24	23,5	23	22,5	21,5	20,5	19	16	14							80	65		
BSN 65 125A 2	7,5	10	26,0	26,5	27,0	27,0	26,8	26,6	26,4	26	26	24,5	23,5	23	21,5	18,5	17							80	65		
BSN 65 160C 2	9,2	12,5	31,5	32,5	33,5	34,0	34,0	33,5	33	32,8	32,5	32	31	30	29,5	27,5	26,5	22						80	65		
BSN 65 160B 2	11	15	36,5	38,0	38,5	39,0	39,0	39	38,8	38,5	38,2	38	37	36,5	35,5	33,5	32,5	28						80	65		
BSN 65 160A 2	15	20	41,5	43,5	44,5	44,8	44,8	45,0	44,8	44,5	44,2	44	43,5	43	42	40	39	34,5						80	65		
BSN 65 200C 2	15	20,0	44,5	45,5	46,5	46,5	46,5	46,5	46,5	46,2	46	45,8	45,5	45	44,5	42,5	41,5	37,5	34,5	30,5				80	65		
BSN 65 200B 2	18,5	25	48,0	49,5	50,0	50,2	50,5	50,5	50,5	50,2	50	49,8	49,5	49	48,5	47	46	42,5	39	35,5				80	65		
BSN 65 200A 2	22	30	52,5	53,5	54	54,5	54,7	54,8	54,8	54,5	54	53,5	53,5	53	52	51	47,5	44,5	41					80	65		
BSN 65 250B 2	30	40	71	71,5	72,5	72,5	73	73	73	72,8	72,5	72	71,5	71	70	69	65,5	63	59,5					80	65		
BSN 65 250A 2	37	50	79,5	81	81,5	82	82,5	82,5	82,5	82,5	82,5	82	81,8	81,5	81	79,8	79	75,5	73	69,5				80	65		
BSN 80 125B 2	5,5	7,5	18	19	20	20,2	20,4	20,5	20,5	20	19,8	19,5	19	18,5	18	16,5	15,5	12,5	10,5	8				100	80		
BSN 80 125A 2	7,5	10	24	25,5	25,8	26	26	26	26	25,5	25	24,5	24	23,8	22,5	22	19,5	17,5	15	15				100	80		
BSN 80 160D 2	11	15	27	28,3	28,8	29	29,5	29,7	29,8	29,8	29,8	29,5	29,2	29	28,5	28	26,5	25	23,5	22	20				100	80	
BSN 80 160C 2	15	20	32	33	33,5	34	34,5	34,7	34,5	34,5	34,5	34,5	34,2	34	33,5	33	32	30,5	29	27,5	26				100	80	
BSN 80 160B 2	18,5	25	35	36	36,5	37	37,5	37,5	37,5	37,5	37,5	37,5	37,5	37	37	36,5	35	34,5	33	32	30				100	80	
BSN 80 160A 2	22	30	39	39,5	40	40,5	41	41	41	41,5	41,5	41,5	41,2	41	40,5	40	39	38	37,5	36,5	35				100	80	
BSN 80 200B 2	30	40	53	53,5	54	54,5	54,8	55	55	55	55,3	55,5	55,5	55,8	56	56	56,3	56	55,3	54	49,5	40			100	80	
BSN 80 200A 2	37	50	62,5	63	63,5	64	64,5	64,8	65	65	65	65,3	65,5	65,5	66	66	66,3	66	65,5	65	63	59	53		100	80	
BSN 80 250C 2	45	60	67,5	68,5	69	69,5	70	70	70	70	70	70	70	70	70	70	70	70	68,5	67,5	66	65	63	60,5	50	100	80
BSN 80 250B 2	55	75	82	83,5	85	86	86,5	87	87	87,5	88	88	88	88	88	87,5	87,5	87,5	86	85	83,5	82	81	79,5	70	100	80
BSN 80 250A 2	75	100	101,5	101,8	102	102,5	103	103	103	103,5	103,5	104	104	104	104	104,5	104,5	103,5	103	102,5	102	101,5	100	92	100	80	

CAMPO DELLE PRESTAZIONI / RANGE OF PERFORMANCES

60 Hz - min⁻¹ ~ 3400 - 2 poli

TIPO TYPE Trifase Three-phase	Potenza nominale Nominal power		Q [m ³ /h] Q [l/1']	Portata - Capacity																DNA mm	DNM mm						
				Prevalenza (m C.A.) Total head (m W.C.)																							
				[kW]	[HP]	0	3	6	9	12	15	18	21	24	27	30	33	36	39			42	45	48	57	60	66
BSN 32 125B 2	1,1	1,5	20,9	20,4	19,9	19,4	17,9	16,5	14,1	11,6																50	32
BSN 32 125A 2	1,5	2	25,2	25,7	25,7	25,2	23,3	21,8	19,4	16,0	12,1															50	32
BSN 32 160B 2	2,2	3	29,6	29,6	29,1	28,6	27,6	26,7	24,7	22,3	19,9	16,5														50	32
BSN 32 160A 2	3	4	35,9	36,4	36,4	35,9	35,4	33,5	32,0	30,1	27,2	24,3	21,3													50	32
BSN 32 200C 2	4	5,5	42,7	43,2	42,7	41,7	40,7	39,8	37,8	36,4	34,0	31,5	29,1													50	32
BSN 32 200B 2	5,5	7,5	49,5	50,0	49,5	49,0	48,5	46,6	45,1	43,7	41,2	38,8	36,9													50	32
BSN 32 200A 2	7,5	10	57,7	57,7	57,7	57,2	56,3	55,8	54,3	52,9	50,9	48,5	46,1													50	32
BSN 32 250C 2	9,2	12,5	72,8	72,8	72,8	72,3	71,8	70,8	69,8	67,9	66,0	63,5	60,6	58,2												50	32
BSN 32 250B 2	11	15	86,8	86,8	86,8	86,3	85,8	85,4	84,4	82,9	80,5	78,6	75,2	71,8												50	32
BSN 32 250A 2	15	20	95,1	95,1	95,1	95,1	95,1	94,6	93,1	91,2	89,2	84,9	80,5													50	32
BSN 40 125C 2	1,5	2	17,0	17,3	17,5	18,4	17,8	17,5	17,0	16,5	15,5	14,6	13,1	12,1	10,7	8,2										65	40
BSN 40 125B 2	2,2	3	21,3	21,6	21,8	21,8	21,8	21,6	21,3	20,9	19,9	18,9	17,9	17,5	16,0	14,1	12,1									65	40
BSN 40 125A 2	3	4	25,7	26,2	26,7	26,7	26,7	26,2	25,7	25,5	24,7	24,3	23,0	22,3	20,9	18,9	17,0	15,5								65	40
BSN 40 160B 2	3	4	30,1	30,3	30,6	30,1	29,1	28,9	27,6	26,7	26,2	24,3	22,8	21,3	18,9	16,5	14,1									65	40
BSN 40 160A 2	4	5,5	37,3	37,8	37,6	37,3	36,7	36,4	35,4	34,4	33,5	32,0	31,0	28,6	26,7	24,3	22,3									65	40
BSN 40 200B 2	5,5	7,5	42,7	43,2	43,5	43,7	43,2	43,0	42,2	41,7	40,7	39,3	37,8	35,9	33,5	31,0	28,1	24,3								65	40
BSN 40 200A 2	7,5	10	52,9	53,2	53,4	53,4	53,4	53,2	52,9	52,2	51,4	50,0	48,0	46,6	44,1	41,7	38,8	35,4								65	40
BSN 40 250B 2	11	15	69,8	69,8	70,3	70,1	69,8	68,9	68,4	67,9	66,9	66,0	64,5	63,1	61,6	59,7	57,2	54,3	52,9							65	40
BSN 40 250A 2	15	20	82,0	82,5	82,9	83,2	82,9	82,9	82,6	82,5	82,0	81,5	80,0	78,6	77,1	75,7	73,2	71,3	68,4							65	40
BSN 50 125C 2	2,2	3	17,0	17,5	17,5	17,5	17,5	17,5	17,5	17,3	17,0	16,5	16,0	15,5	15,0	14,6	13,6	13,1	12,1	9,7						65	50
BSN 50 125B 2	3	4	21,8	21,8	21,8	21,8	21,8	21,8	21,3	21,1	20,9	20,4	19,9	19,4	18,9	18,4	17,9	17,0	16,5	14,1						65	50
BSN 50 125A 2	4	5,5	24,7	25,0	25,2	25,2	25,0	24,7	24,7	24,7	24,5	24,3	23,8	23,8	23,3	22,8	22,3	21,8	21,3	18,9						65	50
BSN 50 160B 2	5,5	7,5	30,6	31,0	31,0	31,0	31,0	31,0	30,8	30,6	30,1	29,6	29,1	28,8	28,6	27,6	27,2	26,2	25,7	22,8	21,3	18,9				65	50
BSN 50 160A 2	7,5	10	38,3	38,8	38,8	38,8	38,8	38,8	38,8	38,8	38,6	38,3	37,8	37,3	36,9	36,6	36,4	35,9	35,4	33,0	32,0	30,1	27,2			65	50
BSN 50 200C 2	9,2	12,5	43,7	44,6	45,1	45,3	45,6	45,9	46,1	45,6	45,1	44,6	44,1	43,7	43,2	42,2	41,2	39,8	38,8	33,5	31,5	27,2	22,3			65	50
BSN 50 200B 2	11	15	50,9	51,9	52,4	52,9	52,9	52,9	52,9	52,9	52,4	52,2	51,9	50,4	49,5	48,5	47,5	46,1	45,1	40,7	38,3	34,4	29,1			65	50
BSN 50 200A 2	15	20	57,7	58,7	59,2	59,7	59,7	59,7	59,7	59,7	59,2	58,7	58,2	57,2	56,7	55,3	54,3	53,4	51,9	46,6	45,1	40,7	36,4			65	50
BSN 50 250C 2	15	20	70,8	71,3	71,8	72,3	72,8	72,8	72,8	72,8	72,8	72,6	72,3	71,3	70,3	69,8	69,4	68,9	67,9	65,0	63,1	60,1	56,3	52,4		65	50
BSN 50 250B 2	18,5	25	79,5	79,8	80,0	80,0	80,0	80,0	80,0	80,0	80,0	79,8	79,5	79,1	78,6	77,6	77,1	76,6	75,7	71,8	70,3	67,9	64,5	59,7		65	50
BSN 50 250A 2	22	30	86,8	87,3	87,8	88,1	88,3	88,3	88,3	88,1	87,8	87,5	87,3	86,8	86,3	85,8	85,4	84,4	83,9	80,5	78,1	75,7	71,8	67,4		65	50

CAMPO DELLE PRESTAZIONI / RANGE OF PERFORMANCES

60 Hz - min⁻¹ ~ 3400 - 2 poli

TIPO TYPE Trifase Three-phase	Potenza nominale Nominal power		Q [m ³ /h] Q [l/1']	Portata - Capacity																				DNA mm	DNM mm		
				Prevalenza (m C.A.) Total head (m W.C.)																							
				[kW]	[HP]	0	12	24	30	36	42	48	54	60	66	72	78	84	96	102	120	132	144			156	168
BSN 65 125B 2	5,5	7,5	22,8	23,8	24,3	24,3	24,3	23,8	23,3	22,8	22,3	21,8	20,9	19,9	18,4	15,5	13,6									80	65
BSN 65 125A 2	7,5	10	25,2	25,7	26,2	26,2	26,0	25,8	25,6	25,2	25,2	23,8	22,8	22,3	20,9	17,9	16,5									80	65
BSN 65 160C 2	9,2	12,5	30,6	31,5	32,5	33,0	33,0	32,5	32,0	31,8	31,5	31,0	30,1	29,1	28,6	26,7	25,7	21,3								80	65
BSN 65 160B 2	11	15	35,4	36,9	37,3	37,8	37,8	37,8	37,6	37,3	37,1	36,9	35,9	35,4	34,4	32,5	31,5	27,2								80	65
BSN 65 160A 2	15	20	40,3	42,2	43,2	43,5	43,5	43,7	43,5	43,2	42,9	42,7	42,2	41,7	40,7	38,8	37,8	33,5								80	65
BSN 65 200C 2	15	20,0	43,2	44,1	45,1	45,1	45,1	45,1	44,8	44,6	44,4	44,1	43,7	43,2	41,2	40,3	36,4	33,5	29,6							80	65
BSN 65 200B 2	18,5	25	46,6	48,0	48,5	48,7	49,0	49,0	49,0	48,7	48,5	48,3	48,0	47,5	47,0	45,6	44,6	41,2	37,8	34,4						80	65
BSN 65 200A 2	22	30	50,9	51,9	52,4	52,9	53,1	53,2	53,2	52,9	52,4	51,9	51,9	51,4	50,4	49,5	46,1	43,2	39,8							80	65
BSN 65 250B 2	30	40	68,9	69,4	70,3	70,3	70,8	70,8	70,6	70,3	70,3	69,8	69,4	68,9	67,9	66,9	63,5	61,1	57,7							80	65
BSN 65 250A 2	37	50	77,1	78,6	79,1	79,5	80,0	80,0	80,0	80,0	80,0	79,5	79,3	79,1	78,6	77,4	76,6	73,2	70,8	67,4						80	65
BSN 80 125B 2	5,5	7,5	17,5	18,4	19,4	19,6	19,8	19,9	19,9	19,4	19,2	18,9	18,4	17,9	17,5	16,0	15,0	12,1	10,2	7,8						100	80
BSN 80 125A 2	7,5	10	23,3	24,7	25,0	25,2	25,2	25,2	25,2	25,2	24,7	24,3	23,8	23,3	23,1	21,8	21,3	18,9	17,0	14,6						100	80
BSN 80 160D 2	11	15	26,2	27,5	27,9	28,1	28,6	28,8	28,9	28,9	28,9	28,9	28,9	28,9	28,8	28,3	28,1	27,6	27,2	25,7	24,3	22,8	21,3	19,4		100	80
BSN 80 160C 2	15	20	31,0	32,0	32,5	33,0	33,5	33,7	33,5	33,5	33,5	33,5	33,5	33,5	33,2	33,0	32,5	32,0	31,0	29,6	28,1	26,7	25,2		100	80	
BSN 80 160B 2	18,5	25	34,0	34,9	35,4	35,9	36,4	36,4	36,4	36,4	36,4	36,4	36,4	36,4	35,9	35,9	35,4	34,0	33,5	32,0	31,0	29,1			100	80	
BSN 80 160A 2	22	30	37,8	38,3	38,8	39,3	39,8	39,8	39,8	40,3	40,3	40,3	40,3	40,0	39,8	39,3	38,8	37,8	36,9	36,4	35,4	34,0			100	80	
BSN 80 200B 2	30	40	51,4	51,9	52,4	52,9	53,2	53,4	53,4	53,4	53,6	53,8	54,1	54,3	54,3	54,6	54,3	53,6	52,4	48,0	38,8				100	80	
BSN 80 200A 2	37	50	60,6	61,1	61,6	62,1	62,6	62,9	62,9	63,1	63,1	63,1	63,3	63,5	64,0	64,0	64,0	63,5	63,1	61,1	57,2	51,4			100	80	
BSN 80 250C 2	45	60	65,5	66,4	66,9	67,4	67,9	67,9	67,9	67,9	67,9	67,9	67,9	67,9	67,9	67,9	67,9	67,9	66,4	65,5	64,0	63,1	61,1	58,7	48,5	100	80
BSN 80 250B 2	55	75	79,5	81,0	82,5	83,4	83,9	84,4	84,4																		

50 Hz - min⁻¹ ~ 1450 - 4 poli

TIPO TYPE Trifase Three-phase	Potenza nominale Nominal power		Q [m ³ /h] Q [l/1']		Portata - Capacity																			DNA mm	DNM mm		
					Prevalenza (m C.A.) Total head (m W.C.)																						
					[kW]	[HP]	0	1,5	3	4,5	6	7,5	9	10,5	12	13,5	15	16,5	18	19,5	21	22,5	24			28,5	30
BSN 32 125B 4	0,25	0,33	5,4	5,3	5,1	5,0	4,6	4,3	3,6	3,0															50	32	
BSN 32 125A 4	0,25	0,33	6,5	6,6	6,6	6,5	6,0	5,6	5,0	4,1	3,1														50	32	
BSN 32 160B 4	0,37	0,5	7,6	7,6	7,5	7,4	7,1	6,9	6,4	5,8	5,1	4,3													50	32	
BSN 32 160A 4	0,37	0,5	9,3	9,4	9,4	9,3	9,1	8,6	8,3	7,8	7,0	6,3	5,5												50	32	
BSN 32 200C 4	0,55	0,75	11,0	11,1	11,0	10,8	10,5	10,3	9,8	9,4	8,8	8,1	7,5												50	32	
BSN 32 200B 4	0,55	0,75	12,8	12,9	12,8	12,6	12,5	12,0	11,6	11,3	10,6	10,0	9,5												50	32	
BSN 32 200A 4	0,75	1,0	14,9	14,9	14,9	14,8	14,5	14,4	14,0	13,6	13,1	12,5	11,9												50	32	
BSN 32 250C 4	0,75	1,0	18,8	18,8	18,8	18,6	18,5	18,3	18,0	17,5	17,0	16,4	15,6	15,0											50	32	
BSN 32 250B 4	1,1	1,5	22,4	22,4	22,4	22,3	22,1	22,0	21,8	21,4	20,8	20,3	19,4	18,5											50	32	
BSN 32 250A 4	1,5	2	24,5	24,5	24,5	24,5	24,5	24,5	24,4	24,0	23,5	23,0	21,9	20,8											50	32	
BSN 40 125C 4	0,25	0,33	4,4	4,5	4,5	4,8	4,6	4,5	4,4	4,3	4,0	3,8	3,4	3,1	2,8	2,1									65	40	
BSN 40 125B 4	0,25	0,33	5,5	5,6	5,6	5,6	5,6	5,6	5,5	5,4	5,1	4,9	4,6	4,5	4,1	3,6	3,1								65	40	
BSN 40 125A 4	0,37	0,5	6,6	6,8	6,9	6,9	6,9	6,8	6,6	6,6	6,4	6,3	5,9	5,8	5,4	4,9	4,4	4,0							65	40	
BSN 40 160B 4	0,37	0,5	7,8	7,8	7,9	7,8	7,5	7,5	7,1	6,9	6,8	6,3	5,9	5,5	4,9	4,3	3,6								65	40	
BSN 40 160A 4	0,55	0,75	9,6	9,8	9,7	9,6	9,5	9,4	9,1	8,9	8,6	8,3	8,0	7,4	6,9	6,3	5,8								65	40	
BSN 40 200B 4	0,75	1,0	11,0	11,1	11,2	11,3	11,1	11,1	10,9	10,8	10,5	10,1	9,8	9,3	8,6	8,0	7,3	6,3							65	40	
BSN 40 200A 4	1,1	1,5	13,6	13,7	13,8	13,8	13,8	13,7	13,6	13,5	13,3	12,9	12,4	12,0	11,4	10,8	10,0	9,1							65	40	
BSN 40 250B 4	1,5	2	18,0	18,0	18,1	18,1	18,0	17,8	17,6	17,5	17,3	17,0	16,6	16,3	15,9	15,4	14,8	14,0	13,6						65	40	
BSN 40 250A 4	2,2	3	21,1	21,3	21,4	21,5	21,4	21,4	21,3	21,3	21,1	21,0	20,6	20,3	19,9	19,5	18,9	18,4	17,6						65	40	
BSN 50 125C 4	0,37	0,5	4,4	4,5	4,5	4,5	4,5	4,5	4,5	4,5	4,4	4,3	4,1	4,0	3,9	3,8	3,5	3,4	3,1	2,5					65	50	
BSN 50 125B 4	0,37	0,5	5,6	5,6	5,6	5,6	5,6	5,6	5,5	5,5	5,4	5,3	5,1	5,0	4,9	4,8	4,6	4,4	4,3	3,6					65	50	
BSN 50 125A 4	0,55	0,75	6,4	6,5	6,5	6,5	6,5	6,4	6,4	6,3	6,3	13,7	6,1	6,0	5,9	5,8	5,6	5,5	4,9						65	50	
BSN 50 160B 4	0,75	1,0	7,9	8,0	8,0	8,0	8,0	8,0	8,0	7,9	7,8	7,6	7,5	7,4	7,4	7,1	7,0	6,8	6,6	5,9	5,5	4,9			65	50	
BSN 50 160A 4	1,1	1,5	9,9	10,0	10,0	10,0	10,0	10,0	10,0	10,0	10,0	9,9	9,8	9,6	9,5	9,4	9,4	9,3	9,1	8,5	8,3	7,8	7,0		65	50	
BSN 50 200C 4	1,1	1,5	11,3	11,5	11,6	11,7	11,8	11,8	11,9	11,8	11,6	11,5	11,4	11,3	11,1	10,9	10,6	10,3	10,0	8,6	8,1	7,0	5,8		65	50	
BSN 50 200B 4	1,5	2	13,1	13,4	13,5	13,6	13,6	13,6	13,6	13,5	13,5	13,4	13,0	12,8	12,5	12,3	11,9	11,6	10,5	9,9	8,9	7,5			65	50	
BSN 50 200A 4	2,2	3	14,9	15,1	15,3	15,4	15,4	15,4	15,3	15,3	15,1	15,0	14,8	14,6	14,3	14,0	13,8	13,4	12,0	11,6	10,5	9,4			65	50	
BSN 50 250C 4	2,2	3	18,3	18,4	18,5	18,6	18,8	18,8	18,8	18,8	18,8	18,7	18,6	18,4	18,1	18,0	17,9	17,8	17,5	16,8	16,3	15,5	14,5	13,5		65	50
BSN 50 250B 4	3	4	20,5	20,6	20,6	20,6	20,6	20,6	20,6	20,6	20,6	20,6	20,5	20,4	20,3	20,0	19,9	19,8	19,5	18,5	18,1	17,5	16,6	15,4		65	50
BSN 50 250A 4	3	4	22,4	22,5	22,6	22,7	22,8	22,8	22,8	22,7	22,6	22,6	22,5	22,4	22,3	22,1	22,0	21,8	21,6	20,8	20,1	19,5	18,5	17,4		65	50

CAMPO DELLE PRESTAZIONI / RANGE OF PERFORMANCES

50 Hz - min⁻¹ ~ 1450 - 4 poli

TIPO TYPE Trifase Three-phase	Potenza nominale Nominal power		Q [m ³ /h] Q [l/1']		Portata - Capacity																			DNA mm	DNM mm		
					Prevalenza (m C.A.) Total head (m W.C.)																						
					[kW]	[HP]	0	6	12	15	18	21	24	27	30	33	36	39	42	48	51	60	66			72	78
BSN 65 125B 4	0,75	1,0	5,9	6,1	6,3	6,3	6,3	6,1	6,0	5,9	5,8	5,6	5,4	5,1	4,8	4,0	3,5								80	65	
BSN 65 125A 4	1,1	1,5	6,5	6,6	6,8	6,8	6,7	6,7	6,6	6,5	6,5	6,1	5,9	5,8	5,4	4,6	4,3								80	65	
BSN 65 160C 4	1,1	1,5	7,9	8,1	8,4	8,5	8,5	8,4	8,3	8,2	8,1	8,0	7,8	7,5	7,4	6,9	6,6	5,5							80	65	
BSN 65 160B 4	1,5	2	9,1	9,5	9,6	9,8	9,8	9,8	9,7	9,6	9,6	9,5	9,3	9,1	8,9	8,4	8,1	7,0							80	65	
BSN 65 160A 4	2,2	3	10,4	10,9	11,1	11,2	11,2	11,3	11,2	11,1	11,1	11,0	10,9	10,8	10,5	10,0	9,8	8,6							80	65	
BSN 65 200C 4	2,2	3	11,1	11,4	11,6	11,6	11,6	11,6	11,6	11,5	11,5	11,4	11,3	11,1	10,6	10,4	9,4	8,6	7,6						80	65	
BSN 65 200B 4	2,2	3	12,0	12,4	12,5	12,6	12,6	12,6	12,6	12,5	12,5	12,4	12,3	12,1	11,8	11,5	10,6	9,8	8,9						80	65	
BSN 65 200A 4	3	4	13,1	13,4	13,5	13,6	13,7	13,7	13,7	13,7	13,6	13,5	13,4	13,4	13,3	13,0	12,8	11,9	11,1	10,3					80	65	
BSN 65 250B 4	4	5,5	17,8	17,9	18,1	18,1	18,3	18,3	18,2	18,1	18,1	18,0	17,9	17,8	17,5	17,3	16,4	15,8	14,9						80	65	
BSN 65 250A 4	5,5	7,5	19,9	20,3	20,4	20,5	20,6	20,6	20,6	20,6	20,5	20,5	20,4	20,3	20,0	19,8	18,9	18,3	17,4						80	65	
BSN 80 125B 4	1,1	1,5	4,5	4,8	5,0	5,1	5,1	5,1	5,0	5,0	4,9	4,8	4,6	4,5	4,1	3,9	3,1	2,6	2,0						100	80	
BSN 80 125A 4	1,5	2	6,0	6,4	6,5	6,5	6,5	6,5	6,5	6,5	6,4	6,3	6,1	6,0	6,0	5,6	5,5	4,9	4,4	3,8					100	80	
BSN 80 160D 4	1,5	2	6,8	7,1	7,2	7,3	7,4	7,4	7,5	7,5	7,5	7,5	7,4	7,3	7,3	7,1	7,0	6,6	6,3	5,9	5,5	5,0			100	80	
BSN 80 160C 4	2,2	3	8,0	8,3	8,4	8,5	8,6	8,7	8,6	8,6	8,6	8,6	8,6	8,6	8,5	8,4	8,3	8,0	7,6	7,3	6,9	6,5			100	80	
BSN 80 160B 4	3	4	8,8	9,0	9,1	9,3	9,4	9,4	9,4	9,4	9,4	9,4	9,4	9,4	9,3	9,3	9,1	8,8	8,6	8,3	8,0	7,5			100	80	
BSN 80 160A 4	4	5,5	9,8	9,9	10,0	10,1	10,3	10,3	10,3	10,4	10,4	10,4	10,3	10,3	10,1	10,0	9,8	9,5	9,4	9,1	8,8				100	80	
BSN 80 200B 4	4	5,5	13,3	13,4	13,5	13,6	13,7	13,8	13,8	13,8	13,8	13,8	13,9	13,9	14,0	14,0	14,0	14,1	14,0	13,8	13,5	12,4	10,0		100	80	
BSN 80 200A 4	4	5,5	15,6	15,8	15,9	16,0	16,1	16,2	16,3	16,3	16,3	16,3	16,4	16,4	16,5	16,5	16,6	16,5	16,4	16,3	15,8	14,8	13,3		100	80	
BSN 80 250C 4	4	5,5	16,9	17,1	17,3	17,4	17,5	17,5	17,5	17,5	17,5	17,5	17,5	17,5	17,5	17,5	17,5	17,1	16,9	16,5	16,3	15,8	15,1	12,5	100	80	
BSN 80 250B 4	5,5	7,5	20,5	20,9	21,3	21,5	21,6	21,8	21,8	21,9	22,0	22,0	22,0	22,0	22,0	21,9	21,9	21,9	21,5	21,3	20,9	20,5	20,3	19,9	17,5	100	80
BSN 80 250A 4	7,5	10	25,4	25,5	25,5	25,6	25,8	25,8	25,8	25,8	25,9	25,9	26,0	26,0	26,0	26,0	26,1	26,1	25,9	25,8	25,6	25,5	25,4	25,0	23,0	100	80

CAMPO DELLE PRESTAZIONI / RANGE OF PERFORMANCES

60 Hz - min⁻¹ ~ 1760 - 4 poli

TIPO TYPE Trifase Three-phase	Potenza nominale Nominal power		Portata - Capacity																				DNA mm	DNM mm			
			Q [m ³ /h] Q [l/1']																								
			Prevalenza (m C.A.) Total head (m W.C.)																								
[kW]	[HP]	0	4,5	6	7,5	9	10,5	12	13,5	15	16,5	18	19,5	21	22,5	24	28,5	30	33	36	39	0	0				
BSN 32 125B 4	0,25	0,33	5,0	4,9	4,5	4,1	3,5	2,9	0,0	0,0														50	32		
BSN 32 125A 4	0,25	0,33	6,4	6,3	5,8	5,5	4,9	4,0	3,0	0,0	0,0														50	32	
BSN 32 160B 4	0,37	0,5	7,3	7,2	6,9	6,7	6,2	5,6	5,0	4,1	0,0	0,0													50	32	
BSN 32 160A 4	0,37	0,5	9,1	9,0	8,9	8,4	8,0	7,5	6,8	6,1	5,3	0,0	0,0												50	32	
BSN 32 200C 4	0,55	0,75	10,7	10,4	10,2	9,9	9,5	9,1	8,5	7,9	7,3	0,0	0,0												50	32	
BSN 32 200B 4	0,55	0,75	12,4	12,2	12,1	11,6	11,3	10,9	10,3	9,7	9,2	0,0	0,0												50	32	
BSN 32 200A 4	0,75	1,0	14,4	14,3	14,1	13,9	13,6	13,2	12,7	12,1	11,5	0,0	0,0												50	32	
BSN 32 250C 4	0,75	1,0	18,2	18,1	17,9	17,7	17,5	17,0	16,5	15,9	15,2	14,6	0,0	0,0											50	32	
BSN 32 250B 4	1,1	1,5	21,7	21,6	21,5	21,3	21,1	20,7	20,1	19,6	18,8	17,9	0,0	0,0											50	32	
BSN 32 250A 4	1,5	2	23,8	23,8	23,8	23,8	23,6	23,3	22,8	22,3	21,2	20,1	0,0	0,0											50	32	
BSN 40 125C 4	0,25	0,33	4,4	4,6	4,4	4,4	4,2	4,1	3,9	3,6	3,3	3,0	2,7	2,1	0,0	0,0									65	40	
BSN 40 125B 4	0,25	0,33	5,5	5,5	5,5	5,4	5,3	5,2	5,0	4,7	4,5	4,4	4,0	3,5	3,0	0,0	0,0								65	40	
BSN 40 125A 4	0,37	0,5	6,7	6,7	6,7	6,5	6,4	6,4	6,2	6,1	5,7	5,6	5,2	4,7	4,2	3,9	0,0	0,0							65	40	
BSN 40 160B 4	0,37	0,5	7,6	7,5	7,3	7,2	6,9	6,7	6,5	6,1	5,7	5,3	4,7	4,1	3,5	0,0	0,0								65	40	
BSN 40 160A 4	0,55	0,75	9,4	9,3	9,2	9,1	8,9	8,6	8,4	8,0	7,8	7,2	6,7	6,1	5,6	0,0	0,0								65	40	
BSN 40 200B 4	0,75	1,0	10,9	10,9	10,8	10,7	10,5	10,4	10,2	9,8	9,5	9,0	8,4	7,8	7,0	6,1	0,0	0,0							65	40	
BSN 40 200A 4	1,1	1,5	13,3	13,3	13,3	13,3	13,2	13,0	12,9	12,5	12,0	11,6	11,0	10,4	9,7	8,9	0,0	0,0							65	40	
BSN 40 250B 4	1,5	2	17,6	17,5	17,5	17,2	17,1	17,0	16,7	16,5	16,1	15,8	15,4	14,9	14,3	13,6	13,2	0,0	0,0						65	40	
BSN 40 250A 4	2,2	3	20,7	20,8	20,7	20,7	20,7	20,6	20,5	20,4	20,0	19,6	19,3	18,9	18,3	17,8	17,1	0,0	0,0						65	40	
BSN 50 125C 4	0,37	0,5	4,4	4,4	4,4	4,4	4,4	4,3	4,2	4,1	4,0	3,9	3,8	3,6	3,4	3,3	3,0	2,4	0,0	0,0					65	50	
BSN 50 125 B 4	0,37	0,5	5,5	5,5	5,5	5,5	5,3	5,3	5,2	5,1	5,0	4,9	4,7	4,6	4,5	4,2	4,1	3,5	0,0	0,0					65	50	
BSN 50 125A 4	0,55	0,75	6,3	6,3	6,3	6,2	6,2	6,1	6,1	13,3	5,9	5,8	5,7	5,6	5,5	5,3	4,7	0,0	0,0						65	50	
BSN 50 160B 4	0,75	1,0	7,8	7,8	7,8	7,8	7,7	7,6	7,5	7,4	7,3	7,2	7,2	6,9	6,8	6,5	6,4	5,7	5,3	4,7	0,0	0,0			65	50	
BSN 50 160A 4	1,1	1,5	9,7	9,7	9,7	9,7	9,7	9,7	9,6	9,5	9,3	9,2	9,1	9,1	9,0	8,9	8,2	8,0	7,5	6,8	0,0	16,3			65	50	
BSN 50 200C 4	1,1	1,5	11,3	11,3	11,4	11,5	11,5	11,4	11,3	11,2	11,0	10,9	10,8	10,5	10,3	9,9	9,7	8,4	7,9	6,8	5,6	0,0	16,3			65	50
BSN 50 200B 4	1,5	2	13,1	13,2	13,2	13,2	13,2	13,2	13,1	13,0	13,0	12,6	12,4	12,1	11,9	11,5	11,3	10,2	9,6	8,6	7,3	0,0	16,3			65	50
BSN 50 200A 4	2,2	3	14,8	14,9	14,9	14,9	14,9	14,8	14,7	14,6	14,3	14,2	13,8	13,6	13,3	13,0	11,6	11,3	10,2	9,1	0,0	16,3			65	50	
BSN 50 250C 4	2,2	3	17,9	18,1	18,2	18,2	18,2	18,2	18,2	18,1	18,1	17,8	17,6	17,5	17,3	17,2	17,0	16,2	15,8	15,0	14,1	13,1	16,3	12,5		65	50
BSN 50 250B 4	3	4	20,0	20,0	20,0	20,0	20,0	20,0	20,0	20,0	19,9	19,8	19,6	19,4	19,3	19,2	18,9	17,9	17,6	17,0	16,1	14,9	16,3	12,5		65	50
BSN 50 250A 4	3	4	21,9	22,0	22,1	22,1	22,1	22,0	21,9	21,9	21,8	21,7	21,6	21,5	21,3	21,1	21,0	20,1	19,5	18,9	17,9	16,9	16,3	12,5		65	50

CAMPO DELLE PRESTAZIONI / RANGE OF PERFORMANCES

60 Hz - min⁻¹ ~ 1760 - 4 poli

TIPO TYPE Trifase Three-phase	Potenza nominale Nominal power		Portata - Capacity																				DNA mm	DNM mm				
			Q [m ³ /h] Q [l/1']																									
			Prevalenza (m C.A.) Total head (m W.C.)																									
[kW]	[HP]	0	15	18	21	24	27	30	33	36	39	42	48	51	60	66	72	78	84	90	96	120	0	0				
BSN 65 125B 4	0,75	1,0	6,1	6,1	6,1	5,9	5,8	5,7	5,6	5,5	5,2	5,0	4,6	3,9	3,4	0,0	0,0								80	65		
BSN 65 125A 4	1,1	1,5	6,5	6,5	6,5	6,5	6,4	6,3	6,3	5,9	5,7	5,6	5,2	4,5	4,1	0,0	0,0								80	65		
BSN 65 160C 4	1,1	1,5	8,1	8,2	8,2	8,1	8,0	8,0	7,9	7,8	7,5	7,3	7,2	6,7	6,4	5,3	0,0	0,0							80	65		
BSN 65 160B 4	1,5	2	9,3	9,5	9,5	9,5	9,4	9,3	9,3	9,2	9,0	8,9	8,6	8,1	7,9	6,8	0,0	0,0							80	65		
BSN 65 160A 4	2,2	3	10,8	10,9	10,9	10,9	10,9	10,8	10,7	10,7	10,5	10,4	10,2	9,7	9,5	8,4	0,0	0,0							80	65		
BSN 65 200C 4	2,2	3	11,3	11,3	11,3	11,3	11,3	11,2	11,2	11,1	11,0	10,9	10,8	10,3	10,1	9,1	8,4	7,4	0,0	0,0					80	65		
BSN 65 200B 4	2,2	3	12,1	12,2	12,2	12,2	12,2	12,2	12,1	12,1	12,0	11,9	11,8	11,4	11,2	10,3	9,5	8,6	0,0	0,0					80	65		
BSN 65 200A 4	3	4	13,1	13,2	13,3	13,3	13,3	13,3	13,2	13,1	13,0	13,0	12,9	12,6	12,4	11,5	10,8	9,9	0,0	0,0					80	65		
BSN 65 250B 4	4	5,5	17,6	17,6	17,7	17,7	17,7	17,7	17,6	17,6	17,5	17,3	17,2	17,0	16,7	15,9	15,3	14,4	0,0	0,0					80	65		
BSN 65 250A 4	5,5	7,5	19,8	19,9	20,0	20,0	20,0	20,0	20,0	19,9	19,8	19,8	19,6	19,4	19,2	18,3	17,7	16,9	0,0	0,0					80	65		
BSN 80 125B 4	1,1	1,5	4,9	4,9	4,9	5,0	5,0	4,9	4,8	4,7	4,6	4,5	4,4	4,0	3,8	3,0	2,5	1,9	0,0	0,0					100	80		
BSN 80 125A 4	1,5	2	6,3	6,3	6,3	6,3	6,3	6,2	6,1	5,9	5,8	5,8	5,5	5,3	4,7	4,2	3,6	0,0	0,0						100	80		
BSN 80 160D 4	1,5	2	7,0	7,0	7,2	7,2	7,2	7,2	7,2	7,2	7,1	7,0	6,9	6,8	6,4	6,1	5,7	5,3	4,9	0,0	0,0				100	80		
BSN 80 160C 4	2,2	3	8,1	8,2	8,4	8,4	8,4	8,4	8,4	8,4	8,4	8,3	8,2	8,1	8,0	7,8	7,4	7,0	6,7	6,3	0,0	0,0			100	80		
BSN 80 160B 4	3	4	8,9	9,0	9,1	9,1	9,1	9,1	9,1	9,1	9,1	9,1	9,0	9,0	8,9	8,5	8,4	8,0	7,8	7,3	0,0	0,0			100	80		
BSN 80 160A 4	4	5,5	9,7	9,8	9,9	9,9	9,9	10,1	10,1	10,1	10,1	10,0	9,9	9,8	9,7	9,5	9,2	9,1	8,9	8,5	0,0	0,0			100	80		
BSN 80 200B 4	4	5,5	13,1	13,2	13,3	13,3	13,3	13,3	13,4	13,5	13,5	13,5	13,6	13,6	13,7	13,6	13,4	13,1	12,0	9,7	0,0	0,0			100	80		
BSN 80 200A 4	4	5,5	15,4	15,5	15,6	15,7	15,7	15,8	15,8	15,8	15,8	15,9	15,9	16,0	16,0	16,1	16,0	15,9	15,8	15,3	14,3	12,9	0,0	25,0		100	80	
BSN 80 250C 4	4	5,5	16,7	16,9	17,0	17,0	17,0	17,0	17,0	17,0	17,0	17,0	17,0	17,0	17,0	16,6	16,4	16,0	15,8	15,3	14,7	12,1	25,0	20,0		100	80	
BSN 80 250B 4	5,5	7,5	20,6	20,9	21,0	21,1	21,1	21,2	21,3	21,3	21,3	21,3	21,3	21,2	21,2	21,2	20,9	20,6	20,2	19,9	19,6	19,3	17,0	25,0	20,0		100	80
BSN 80 250A 4	7,5	10	24,7	24,9	25,0	25,0	25,0	25,0	25,1	25,1	25,2	25,2	25,2	25,2	25,3	25,3	25,1	25,0	24,9	24,7	24,6	24,3	22,3	25,0	20,0		100	80

CAMPO DELLE PRESTAZIONI / RANGE OF PERFORMANCES

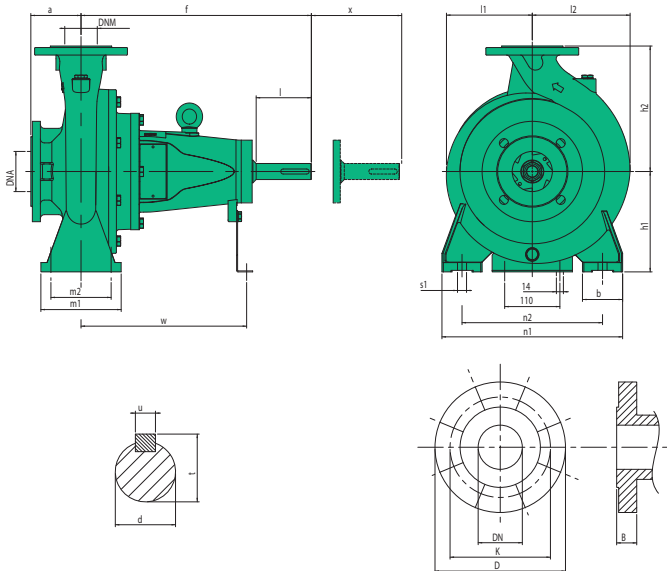

Flange - Flanges - Brides - Bidas
mm

DN	K	D	B	fori - holes - orifices - orificios	
				n°	Ø
32	100	140	18	4	18
40	110	150	18	4	18
50	125	165	19	4	18
65	145	185	19	4	18
80	160	200	22	4	18
100	180	220	24	8	18

Flange - Flanges - Brides - Bidas
mm

d	l	u	t
24 j6	50	8	27
32 k6	80	10	35
42 k6	110	12	45

TIPO TYPE	DIMENSIONI [mm] DIMENSIONS [mm]																
	DNA	DNM	a	f	h1	h2	l1	l2	m1	m2	n1	n2	b	s1	d	w	x
BSN 32 125	50	32	80	356	112	140	102	102	100	70	190	140	50	14	24	254	100
BSN 32 160	50	32	80	360	132	160	116,5	116,5	100	70	240	190	50	14	24	254	100
BSN 32 200	50	32	80	356	160	180	140	140	100	70	240	190	50	14	24	254	100
BSN 32 250	50	32	100	360	180	225	166	166	125	95	320	250	65	14	24	254	100
BSN 40 125	65	40	80	356	132	160	116,5	116,5	100	70	240	190	50	14	24	254	100
BSN 40 160	65	40	80	360	132	160	116,5	121,5	100	70	240	190	50	14	24	254	100
BSN 40 200	65	40	100	356	160	180	140	140	100	70	265	212	50	14	24	254	100
BSN 40 250	65	40	100	360	180	225	166	166	125	95	320	250	65	14	24	254	100
BSN 50 125	65	50	80	356	132	160	101,5	112	100	70	210	190	50	14	24	254	100
BSN 50 160	65	50	100	356	160	180	120	136	100	70	265	212	50	14	24	254	100
BSN 50 200	65	50	100	360	160	200	140	150	100	70	265	212	50	14	24	254	100
BSN 50 250	65	50	100	360	180	225	166	170	125	95	320	250	65	14	24	254	100
BSN 65 125	80	65	100	356	160	180	112	143	125	95	280	212	65	14	24	254	100
BSN 65 160	80	65	100	365	160	200	123	148	125	95	280	212	65	14	24	258	100
BSN 65 200	80	65	100	365	180	225	147	168	125	95	320	250	65	14	24	258	140
BSN 65 250	80	65	100	460	200	250	170	195	160	120	360	280	80	18	32	330	140
BSN 80 125	100	80	100	360	160	180	120	145	125	95	280	212	65	14	24	258	100
BSN 80 160	100	80	125	365	180	225	135	170	125	95	320	250	65	14	24	258	140
BSN 80 200	100	80	125	470	180	250	165	195	125	95	350	280	65	18	32	340	140
BSN 80 250	100	80	125	470	200	280	195	218	160	120	400	315	80	18	32	340	140

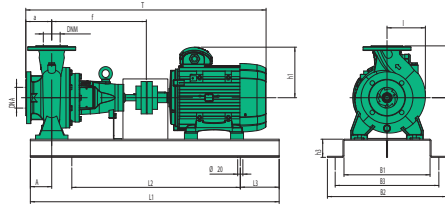

TIPO TYPE	MOTOR	DIMENSIONI [mm] DIMENSIONS [mm]																
		DNA	DNM	a	f	H	h1	h2	L1	L2	L3	B1	B2	B3	A	h3	T	
BSN 32 125 B 2	80 B	50	32	80	356	182	129	140	770	470	150	260	380	320	60	70	708	
33 125 A 2	90 S A	50	32	80	356	182	138	140	770	470	150	260	380	320	60	70	753	
BSN 32 160 B 2	90 L C	50	32	80	360	202	138	160	770	470	150	260	380	320	60	70	757	
32 160 A 2	100 L A	50	32	80	360	202	145	160	850	550	150	260	380	320	60	70	806	
BSN 32 200 C 2	112 M A	50	32	80	356	230	161	180	850	550	150	260	380	320	60	70	824	
32 200 B 2	132 S Y	50	32	80	356	230	198	180	890	590	150	340	460	400	60	70	885,5	
32 200 A 2	132 S Z	50	32	80	356	230	198	180	890	590	150	340	460	400	60	70	885,5	
BSN 32 250 C 2	132 M Z	50	32	100	360	250	198	225	960	660	150	340	460	400	75	70	947,5	
32 250 B 2	160 M V	50	32	100	360	250	246	225	1160	860	150	360	480	420	75	70	1073	
32 250 A 2	160 M X	50	32	100	360	250	246	225	1160	860	150	360	480	420	75	70	1073	
BSN 40 125 C 2	90 S A	65	40	80	356	202	138	160	770	470	150	260	380	320	60	70	753	
40 125 B 2	90 L C	65	40	80	356	202	138	160	770	470	150	260	380	320	60	70	753	
40 125 A 2	100 L A	65	40	80	356	202	145	160	850	550	150	260	380	320	60	70	802	
BSN 40 160 B 2	100 L A	65	40	80	360	202	145	160	850	550	150	260	380	320	60	70	806	
40 160 A 2	112 M A	65	40	80	360	202	161	160	850	550	150	260	380	320	60	70	828	
BSN 40 200 B 2	132 S Y	65	40	100	356	230	198	180	960	660	150	340	460	400	60	70	905,5	
40 200 A 2	132 S Z	65	40	100	356	230	198	180	960	660	150	340	460	400	60	70	905,5	
BSN 40 250 B 2	160 M V	65	40	100	360	250	246	225	1160	860	150	360	480	420	75	70	1073	
40 250 A 2	160 M X	65	40	100	360	250	246	225	1160	860	150	360	480	420	75	70	1073	
BSN 50 125 C 2	90 L C	65	50	80	356	202	138	160	770	470	150	260	380	320	60	70	753	
50 125 B 2	100 L A	65	50	80	356	202	145	160	850	550	150	260	380	320	60	70	802	
50 125 A 2	112 M A	65	50	80	356	202	161	160	850	550	150	260	380	320	60	70	824	
BSN 50 160 B 2	132 S Y	65	50	100	356	230	198	180	960	660	150	340	460	400	60	70	905,5	
50 160 A 2	132 S Z	65	50	100	356	230	198	180	960	660	150	340	460	400	60	70	905,5	
BSN 50 200 C 2	132 M Z	65	50	100	360	230	198	200	960	660	150	340	460	400	60	70	947,5	
50 200 B 2	160 M V	65	50	100	360	230	246	200	1160	860	150	360	480	420	60	70	1073	
50 200 A 2	160 M X	65	50	100	360	230	246	200	1160	860	150	360	480	420	60	70	1073	
BSN 50 250 C 2	160 M X	65	50	100	360	250	246	225	1160	860	150	360	480	420	75	70	1073	
50 250 B 2	160 L X	65	50	100	360	250	246	225	1160	860	150	360	480	420	75	70	1117	
50 250 A 2	180 M X	65	50	100	360	250	266	225	1190	890	150	400	520	460	75	70	1172	
BSN 65 125 B 2	132 S Y	80	65	100	356	230	198	180	960	660	150	340	460	400	75	70	905,5	
65 125 A 2	132 S Z	80	65	100	356	230	198	180	960	660	150	340	460	400	75	70	905,5	
BSN 65 160 C 2	132 M Z	80	65	100	365	230	198	200	960	660	150	340	460	400	75	70	952,5	
65 160 B 2	160 M V	80	65	100	365	230	246	200	1160	860	150	360	480	420	75	70	1078	
65 160 A 2	160 M X	80	65	100	365	230	246	200	1160	860	150	360	480	420	75	70	1078	
BSN 65 200 C 2	160 M X	80	65	100	365	250	246	225	1160	860	150	360	480	420	75	70	1078	
65 200 B 2	160 L X	80	65	100	365	250	246	225	1160	860	150	360	480	420	75	70	1122	
65 200 A 2	180 M X	80	65	100	365	250	266	225	1190	890	150	400	520	460	75	70	1177	
BSN 65 250 B 2	200 L L	80	65	100	460	270	341	250	1390	1090	150	400	520	460	90	70	1339	
65 250 A 2	200 L N	80	65	100	460	270	341	250	1390	1090	150	400	520	460	90	70	1339	
BSN 80 125 B 2	132 S Y	100	80	100	360	230	198	180	960	660	150	340	460	400	75	70	909,5	
80 125 A 2	132 S Z	100	80	100	360	230	198	180	960	660	150	340	460	400	75	70	909,5	
BSN 80 160 D 2	160 M V	100	80	125	365	250	246	225	1160	860	150	360	480	420	75	70	1103	
80 160 C 2	160 M X	100	80	125	365	250	246	225	1160	860	150	360	480	420	75	70	1103	
80 160 B 2	160 L X	100	80	125	365	250	246	225	1160	860	150	360	480	420	75	70	1147	
80 160 A 2	180 M X	100	80	125	365	250	266	225	1160	860	150	360	480	420	75	70	1202	
BSN 80 200 B 2	200 L L	100	80	125	470	250	341	250	1390	1090	150	400	520	460	75	70	1374	
80 200 A 2	200 L N	100	80	125	470	250	341	250	1390	1090	150	400	520	460	75	70	1374	
BSN 80 250 C 2	225 M N	100	80	125	470	270	360	280	1500	1200	150	450	630	600	90	70	1452,5	
80 250 B 2	250 M N	100	80	125	470	270	390	280	1500	1200	150	450	630	600	90	70	1566,5	
80 250 A 2	280 S T	100	80	125	470	270	423	280	1500	1200	150	450	630	600	90	70	1632	

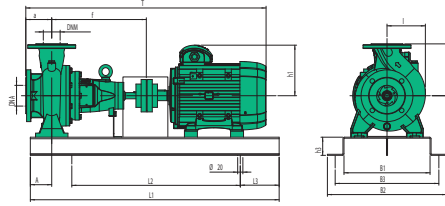

TIPO TYPE	MOTOR	DIMENSIONI [mm] DIMENSIONS [mm]															
		DNA	DNM	a	f	H	h1	h2	L1	L2	L3	B1	B2	B3	A	h3	T
BSN 32 125 B 4	71 Z A	50	32	80	356	182	112	140	700	400	150	260	380	320	60	70	681
32 125 A 4	71 Z A	50	32	80	356	182	112	140	700	400	150	260	380	320	60	70	681
BSN 32 160 B 4	71 Z B	50	32	80	360	202	112	160	700	400	150	260	380	320	60	70	685
32 160 A 4	71 Z B	50	32	80	360	202	112	160	700	400	150	260	380	320	60	70	685
BSN 32 200 C 4	80 Z A	50	32	80	356	230	129	180	770	470	150	260	380	320	60	70	708
32 200 B 4	80 Z A	50	32	80	356	230	129	180	770	470	150	260	380	320	60	70	708
32 200 A 4	80 Z B	50	32	80	356	230	129	180	770	470	150	260	380	320	60	70	708
BSN 32 250 C 4	80 Z B	50	32	100	360	250	129	225	790	490	150	340	460	400	75	70	732
32 250 B 4	90 S A	50	32	100	360	250	138	225	790	490	150	340	460	400	75	70	777
32 250 A 4	90 S B	50	32	100	360	250	138	225	790	490	150	340	460	400	75	70	777
BSN 40 125 C 4	71 Z A	65	40	80	356	202	112	160	700	400	150	260	380	320	60	70	681
40 125 B 4	71 Z A	65	40	80	356	202	112	160	700	400	150	260	380	320	60	70	681
40 125 A 4	71 Z B	65	40	80	356	202	112	160	700	400	150	260	380	320	60	70	681
BSN 40 160 B 4	71 Z B	65	40	80	360	202	112	160	700	400	150	260	380	320	60	70	685
40 160 A 4	80 Z A	65	40	80	360	202	129	160	770	470	150	260	380	320	60	70	712
BSN 40 200 B 4	80 Z B	65	40	100	356	230	129	180	790	490	150	340	460	400	60	70	728
40 200 A 4	90 S A	65	40	100	356	230	138	180	790	490	150	340	460	400	60	70	773
BSN 40 250 B 4	90 S B	65	40	100	360	250	138	225	790	490	150	340	460	400	75	70	777
40 250 A 4	100 L A	65	40	100	360	250	145	225	890	590	150	340	460	400	75	70	826
BSN 50 125 C 4	71 Z B	65	50	80	356	202	112	160	700	400	150	260	380	320	60	70	681
50 125 B 4	71 Z B	65	50	80	356	202	112	160	700	400	150	260	380	320	60	70	681
50 125 A 4	80 Z A	65	50	80	356	202	129	160	770	470	150	260	380	320	60	70	708
BSN 50 160 B 4	80 Z B	65	50	100	356	230	129	180	790	490	150	340	460	400	60	70	728
50 160 A 4	90 S A	65	50	100	356	230	138	180	790	490	150	340	460	400	60	70	773
BSN 50 200 C 4	90 S A	65	50	100	360	230	138	200	790	490	150	340	460	400	60	70	777
50 200 B 4	90 S B	65	50	100	360	230	138	200	790	490	150	340	460	400	60	70	777
50 200 A 4	100 L A	65	50	100	360	230	145	200	890	590	150	340	460	400	60	70	826
BSN 50 250 C 4	100 L A	65	50	100	360	250	145	225	890	590	150	340	460	400	75	70	826
50 250 B 4	100 L B	65	50	100	360	250	145	225	890	590	150	340	460	400	75	70	826
50 250 A 4	100 L B	65	50	100	360	250	145	225	890	590	150	340	460	400	75	70	826
BSN 65 125 B 4	80 Z B	80	65	100	356	230	129	180	790	490	150	340	460	400	75	70	728
65 125 A 4	90 S A	80	65	100	356	230	138	180	790	490	150	340	460	400	75	70	773
BSN 65 160 C 4	90 S A	80	65	100	365	230	138	200	790	490	150	340	460	400	75	70	782
65 160 B 4	90 S B	80	65	100	365	230	138	200	790	490	150	340	460	400	75	70	782
65 160 A 4	100 L A	80	65	100	365	230	145	200	890	590	150	340	460	400	75	70	831
BSN 65 200 C 4	100 L A	80	65	100	365	250	145	225	890	590	150	340	460	400	75	70	831
65 200 B 4	100 L A	80	65	100	365	250	145	225	890	590	150	340	460	400	75	70	831
65 200 A 4	100 L B	80	65	100	365	250	145	225	890	590	150	340	460	400	75	70	831
BSN 65 250 B 4	112 M A	80	65	100	460	270	161	250	990	690	150	400	520	460	90	70	948
65 250 A 4	132 S Z	80	65	100	460	270	198	250	990	690	150	400	520	460	90	70	1009,5
BSN 80 125 B 4	90 S A	100	80	100	360	230	138	180	790	490	150	340	460	400	75	70	777
80 125 A 4	90 S B	100	80	100	360	230	138	180	790	490	150	340	460	400	75	70	777
BSN 80 160 D 4	90 S B	100	80	125	365	250	138	225	890	590	150	340	460	400	75	70	807
80 160 C 4	100 L A	100	80	125	365	250	145	225	890	590	150	340	460	400	75	70	856
80 160 B 4	100 L B	100	80	125	365	250	145	225	890	590	150	340	460	400	75	70	856
80 160 A 4	112 M A	100	80	125	365	250	161	225	890	590	150	340	460	400	75	70	878
BSN 80 200 B 4	112 M A	100	80	125	470	250	161	250	990	690	150	400	520	460	75	70	983
80 200 A 4	112 M A	100	80	125	470	250	161	250	990	690	150	400	520	460	75	70	983
BSN 80 250 C 4	112 M A	100	80	125	470	270	161	280	1100	800	150	400	520	460	90	70	983
80 250 B 4	132 S Z	100	80	125	470	270	198	280	1100	800	150	400	520	460	90	70	1044,5
80 250 A 4	132 M Z	100	80	125	470	270	198	280	1100	800	150	400	520	460	90	70	1082,5

"MKV"



NOMENCLATURA PARTI DI RICAMBIO
SPARE PARTS LIST
NOMENCLATURE PIECES DE RECHANGE
NOMENCLATURA REPUESTOS

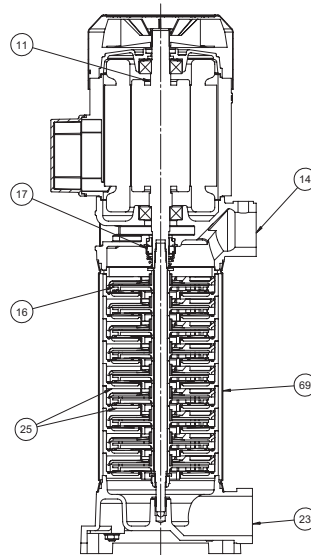
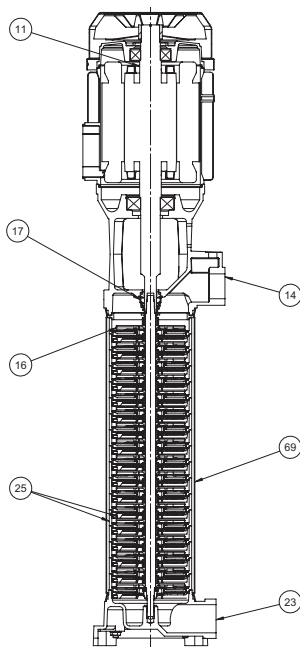

- 11** Albero con rotore – Pump shaft + rotor
Arbre + rotor – Eje rotor
- 14** Supporto mandata – Outlet bracket
Support envoyée – Soporte entrega
- 16** Girante – Impeller
Turbine – Impulsor
- 17** Tenuta meccanica – Mechanical seal
Garniture mécanique – Cierre mecánico
- 23** Corpo flangia aspirante – Suction flange body
Corp bride aspirant – Cuerpo brida entrega
- 25** Diffusore – Diffuser
Diffuseur – Difusor
- 69** Camicia – Cover
Chemise – Camisa

ELETTROPOMPE CENTRIFUGHE MULTISTADIO AD ASSE VERTICALE

Estremamente silenziose ed affidabili, le elettropompe centrifughe ad asse verticale multistadio della serie MKV sono state progettate per pompare liquidi puliti, senza parti abrasive, senza corpi solidi in sospensione, non esplosivi o aggressivi per i materiali della pompa

- Temperatura max. del liquido fino a 35 °C per uso domestico (CEI EN 60335-2-41) o 90 °C per altri usi e temperatura ambiente fino a 40 °C.
- Massima pressione di esercizio 16 bar
- Portate fino a ~ 15 m3/h.
- Prevalenze fino a ~ 160 m.

CARATTERISTICHE COSTRUTTIVE

- Flangia aspirazione: ghisa G20 con trattamento anticorrosione
- Supporto mandata: ghisa G20 con trattamento anticorrosione
- Anello guida in NBR
- Corpo pompa: acciaio Aisi 304
- Diffusori: Tecnopolimero
- Giranti: Tecnopolimero con anello in acciaio inox Aisi 304
- Albero pompa: acciaio inox Aisi 304
- Tenuta meccanica: carbone-ceramica

MOTORE

I motori di comando sono del tipo asincrono a gabbia di scoiattolo chiusi, a ventilazione esterna

- Motoprotettore incorporato e condensatore permanentemente inserito per i tipi monofasi
- La protezione del motore nella versione trifase è a cura del cliente e si raccomandano apparecchiature in accordo con le norme vigenti
- Isolamento classe F –servizio S1- grado di protezione IP 44
- Protezione morsetti IP 54

ÉLECTROPOMPES CENTRIFUGES MULTISTADIO À AXE VERTICAL

Extrêmement silencieuses et fiables, les électropompes centrifuges à axe vertical multistadio de la série MKV ont été conçues pour pomper des liquides propres, sans parties abrasives, sans corps liquides en suspension, non explosifs ou agressifs pour les matériaux de la pompe

- Température max. du liquide jusqu'à 35 °C pour utilisation domestique (CEI EN 60335-2-41) o 90 °C pour d'autres utilisations e température ambiante jusqu'à 40 °C.
- Pression de service maximale 16 bar
- Plage d'utilisation jusqu'à ~ 15 m3/h.
- Hauteur manométrique jusqu'à ~ 160 m.

CARACTERISTIQUES DE CONSTRUCTION

- Bride d'aspiration: En fonte G20 avec traitement anti-corrosion
- Support refoulement: En fonte G20 avec traitement anti-corrosion.
- Corps de pompe : acier inox Aisi 304
- Diffuseurs: Techonopolymère
- Turbine: Techonopolymère avec anneau en acier inox Aisi 304
- Abre de pompe: acier inox Aisi 304
- Garniture mécanique: Carbone dur - Céramique

MOTOR

Le moteurs sont asynchrones à cage d'écureuil fermés a à ventilation extérieure monofásicos,

- Pour les modèles monofasés son avec protection thermique et condensateur connecté en permanence
- Pour les modèles triphasés, la protection est à la charge de l'utilisateur. A recommandé l'équipement conformément à la réglementation
- A Classe d'isolation F - service S 1 – protection IP44
- Protection IP54 dans le terminal

VERTICAL CENTRIFUGAL MULTISTAGE ELECTRIC PUMPS

Extremely noiseless and reliable the vertical centrifugal multistage electric pumps of the series MKV have been designed to pump clean liquids, without abrasives and suspended solids, non-explosive or aggressive for the pump's materials

- Liquid temperature not higher than 35 °C for domestic use (CEI EN 60335-2-41) or 90 °C for other use, while the ambient temperature must not be higher than 40 °C
- Maximum working pressure is 16 bar
- Flow rate up to ~ 15 m3/h
- Heads up to ~ 160 m

TECHNICAL FEATURES

- Suction flange: cast iron G20 with anti-corrosive coating
- Outlet bracket: cast iron G20 with anti-corrosive coating
- Ring guides in NBR
- Diffusers: Techno-polymer
- Pump body: stainless steel Aisi 304
- Impellers: Techno-polymer with stainless steel Aisi 304 ring
- Pump shaft: stainless steel Aisi 304
- Mechanical seal: carbon-ceramics

MOTOR

The control motors are asynchronous, squirrel cage-type, closed, with external ventilation

- Incorporated motor protection and capacitor always on, for single-phase models
- The motor protection for three-phase models must be installed by the customer. Equipment compliant with current standards should be used
- Class of insulation:F-service:S1-Degree of protection: IP 44
- Terminal board protection: IP 54

ELECTROBOMBAS CENTRÍFUGAS MULTIETAPA DE EJE VERTICAL

Extremadamente silenciosas y fiables, las electrobombas centrifugas multi-etapa de eje vertical de la serie MKV han sido proyectadas para bombear líquidos limpios sin partes abrasivas, sin cuerpos sólidos en suspensión, que no sean explosivos ni agresivos para los materiales de la bomba.

- Temperatura max. del líquido hasta 35 °C para uso doméstico (CEI EN 60335-2-41) o 90 °C para otros usos y temperatura ambiente hasta 40 °C.
- Máxima presión de ejercicio 16 bar
- Caudal hasta ~ 15 m3/h.
- Alturas hasta ~ 160 m.

CARACTERÍSTICAS DE CONSTRUCCIÓN

- Cuerpo de bomba: Fundición gris G20 con tratamiento contra-corrosión
- Suporte de salida: Fundición gris G20 con tratamiento contra-corrosión.
- Tubo de bomba: de acero Inox Aisi 304
- Difusores: De tecnopolímero
- Rodetes: De tecnopolímero con el de acero Inox Aisi 304
- Eje de la bomba: de acero Inox Aisi 304
- Cierre mecánico: De cerámica y grafito

MOTOR

Los motores de accionamiento son asíncrono de jaula de ardilla cerrados, ventilados externamente

- Para los modelos monofásicos, protección térmica y condensador incorporado
- Para los modelos trifásicos de la protección se encarga el usuario y el equipo recomendado de acuerdo con las normas
- Aislamiento de Clase F – funcionamiento S1- protección IP44
- Protección IP54 para el terminal

50 Hz - min⁻¹ ~ 2900

TIPO TYPE		Potenza nominale Nominal power		Potenza assorbita Input power [W]		Condensatore Capacitor 450 V max	Corrente assorbita Input current [A]			Portata - Capacity													
Monofase Single-phase	Trifase Three-phase	kW	HP	a	b	[µF]	1~230V	3~230V	3~400V	Q [m³/h]	0	2,4	3	3,6	4,8	6	8,4	9	9,6	10,8	12	15	
										Q [l/v¹]	0	40	50	60	80	100	140	150	160	180	200	250	
											Prevalenza (m C.A.) Total head (m W.C.)												
a	b																						
MKV 3/7 M	MKV 3/7 T	0,74	1	1370	1280	20	6,2	4,2	2,5	72,5	50,8	44,2	37,3	21,9									
MKV 3/9 M	MKV 3/9 T	0,88	1,2	1620	1560	25	7,3	4,5	2,7	88,6	60,2	51,9	43,1	24,1									
MKV 3/10 M	MKV 3/10 T	1,1	1,5	1820	1710	30	8,5	5,2	3,1	103,9	75,4	65,9	55,5	31,9									
MKV 3/12 M	MKV 3/12 T	1,47	2	2060	2040	36	9,2	6,6	3,9	123,1	85,7	74,4	62,3	35,6									
MKV 3/15 M	MKV 3/15 T	1,85	2,5	2660	2580	45	11,7	7,6	4,8	161,7	118,4	104,4	89,1	54,8									
	MKV 3/17 T	2,2	3	-	2980	-	-	9,3	5,2	186,3	138,6	121,5	102,4	57,8									
MKV 6/5 M	MKV 6/5 T	0,88	1,2	1560	1440	25	6,1	4,3	2,5	59,4	51,2	48,5	45,5	38,8	30,9	12,1	6,7						
MKV 6/6 M	MKV 6/6 T	1,1	1,5	1840	1740	30	7,9	5	2,9	74,2	64,6	61,4	58,0	50,2	41,2	19,6	13,5						
MKV 6/7 M	MKV 6/7 T	1,47	2	2080	2050	36	8,5	6,2	3,6	86,2	74,7	70,9	66,8	57,6	46,9	21,4	14,2						
MKV 6/9 M	MKV 6/9 T	1,85	2,5	2630	2540	45	10,5	7,6	4,4	110,5	97,9	93,6	88,7	77,6	64,5	32,4	23,2						
	MKV 6/10 T	2,2	3	-	2730	-	-	8	4,7	122,6	106,6	101,5	95,8	83,0	68,4	33,3	23,3						
MKV 6/12 M	MKV 6/12 T	3	4	3750	3480	80	18,1	10,5	6,4	147,7	133,4	128,1	122,1	107,9	90,9	48,4	36						
	MKV 6/15 T	4	5,5	-	4400	-	-	13,3	7,7	184,9	163,6	156,4	148,5	130,5	109,5	58,7	44,2						
	MKV 6/17 T	4	5,5	-	4920	-	-	15,1	8,4	204,6	184,2	176,4	167,5	146,5	121,2	65,4	51,8						
MKV 9/4 M	MKV 9/4 T	0,88	1,2	1460	1330	25	6,6	4,4	2,5	45,6	41,5	40,3	39,0	36,1	32,9	25,4	23,4	21,2	16,6	11,7			
MKV 9/5 M	MKV 9/5 T	1,1	1,5	1840	1750	30	8,4	5,3	3,1	58,2	53,0	51,6	50,0	46,6	42,9	34,5	32,2	29,9	24,9	19,5			
MKV 9/6 M	MKV 9/6 T	1,47	2	2100	2076	36	9,3	6,8	3,9	68,7	62,6	60,8	58,9	54,7	50	39,1	35,9	32,9	26,6	19,2			
MKV 9/7 M	MKV 9/7 T	1,85	2,5	2450	2430	45	10,9	7,7	4,5	81,1	74,1	72,1	70,1	65,8	61,2	50,1	46,8	43,6	35,1	26,6			
MKV 9/10 M	MKV 9/10 T	3	4	3680	3580	80	18,3	10,8	6,2	111,0	105,1	103,0	100,7	95,3	88,9	73,3	68,8	64	53,8	42,5			
	MKV 9/12 T	3	4	-	4300	-	-	13	7,5	138,6	132,0	129,6	126,8	120,5	112,9	94,2	88,7	83	70,5	56,9			
	MKV 9/15 T	4	5,5	-	5290	-	-	15,6	9	169,1	160,7	157,7	154,2	146,2	136,6	112,7	105,8	98,5	82,7	65,4			
MKV 12/5 M	MKV 12/5 T	1,85	2,5	2810	2670	45	11,4	7,8	4,6	54,3	52,7	52,2	51,5	50,1	48,5	44,4	43,2	41,9	39,3	36,3	28		
MKV 12/6 M	MKV 12/6 T	2,2	3	3500	3100	80	14,7	9,2	5,2	73,0	69,5	68,6	67,6	66,4	64,9	60,2	59	58	54,4	51,3	38,8		
MKV 12/7 M	MKV 12/7 T	3	4	4000	3900	80	20	11,2	6,9	84,6	79,3	78,6	77,9	76,1	73,7	67,7	65,9	63,9	59,7	55	41		
	MKV 12/10 T	4	5,5	-	5450	-	-	15,7	9,3	117,2	115,3	114,4	113,3	110,7	107,5	99,1	96,5	93,9	88	81,5	62,4		
	MKV 12/12 T	5,5	7,5	-	6440	-	-	11,3	7	142,1	139,3	138,1	136,8	133,4	129,3	118,8	115,7	112,4	105,2	97,3	74,1		

a) ~ Monofase 230 V

b) ~ Trifase 230/400 V

60 Hz - min⁻¹ ~ 3400

TIPO TYPE		Potenza nominale Nominal power		Potenza assorbita Input power [W]		Condensatore Capacitor 450 V max	Corrente assorbita Input current [A]			Portata - Capacity													
Monofase Single-phase	Trifase Three-phase	kW	HP	a	b	[µF]	1~220V	3~220V	3~380V	Q [m³/h]	0	2,4	3	3,6	4,8	6	8,4	9	9,6	10,8	12	15	
										Q [l/v¹]	0	40	50	60	80	100	140	150	160	180	200	250	
											Prevalenza (m C.A.) Total head (m W.C.)												
a	b																						
MKV 3/7 M	MKV 3/7 T	0,74	1	1560	1120	20	7,3	4,3	2,6	66,4	52,5	47,4	42,2	30,2									
	MKV 3/9 T	0,88	1,2	-	990	-	-	4,1	2,3	71,7	55,9	50,9	45,5	33,5									
MKV 3/10 M	MKV 3/10 T	1,1	1,5	2200	1320	30	10,3	5,7	3	98,6	77,4	70,1	62,1	43,6									
MKV 3/12 M	MKV 3/12 T	1,47	2	2420	2180	36	11,2	9,3	4,9	116,6	91,3	82,6	72,9	50,5									
	MKV 3/15 T	1,85	2,5	-	2985	-	-	10,8	5,7	147,2	119,0	108,4	96,3	68,0									
	MKV 3/17 T	2,2	3	-	2700	-	-	11	5,8	159,0	123,1	111,3	98,3	69,0									
MKV 6/5 M	MKV 6/5 T	0,88	1,2	1810	1400	30	8,4	5,7	3,2	57,3	52,3	50,4	48,2	42,9	36,6	20,8	16,2						
MKV 6/6 M	MKV 6/6 T	1,1	1,5	2130	1330	30	10	5,7	3,1	66,8	61,9	59,9	57,5	51,7	44,6	26,3	20,9						
MKV 6/7 M	MKV 6/7 T	1,47	2	2230	2060	36	10,3	8,7	4,6	75,9	69,8	66,4	63,7	56,5	48,7	29,7	23,9						
MKV 6/9 M	MKV 6/9 T	1,85	2,5	2800	2900	45	12,8	9,1	5	96,9	88,7	85,4	81,7	72,9	62,1	34,9	26,9						
	MKV 6/10 T	2,2	3	-	2540	-	-	10,5	5,5	108,0	99,4	95,8	91,7	81,8	69,6	38,6	29,5						
	MKV 6/12 T	3	4	-	3000	-	-	12,4	6,5	127,8	116,9	112,7	107,8	96,3	82,3	47	36,6						
	MKV 9/4 T	0,88	1,2	-	970	-	-	4,1	2,3	37,5	34,4	33,5	32,6	30,7	28,6	23,8	22,5	21,2	18,4	15,5			
MKV 9/5 M	MKV 9/5 T	1,1	1,5	2250	1520	30	10,6	7,2	3,8	55,0	52,6	51,8	50,9	48,7	46,2	40	38,2	36,3	32,3	27,9			
MKV 9/6 M	MKV 9/6 T	1,47	2	2600	2310	36	12,1	9,7	5,1	64,6	61,5	60,4	59,3	56,6	53,6	46,1	43,9	41,7	36,8	31,5			
MKV 9/7 M	MKV 9/7 T	1,85	2,5	2920	2420	45	13,4	10	5,3	76,0	72,2	71,0	69,6	66,5	62,9	54,2	51,7	49,1	43,6	37,6			
	MKV 9/10 T	3	4	-	3450	-	-	14	7,3	106,1	102,0	100,5	98,8	94,7	89,9	77,9	74,4	70,7	62,7	53,9			

a) ~ Monofase 220 V

b) ~ Trifase 220/380 V

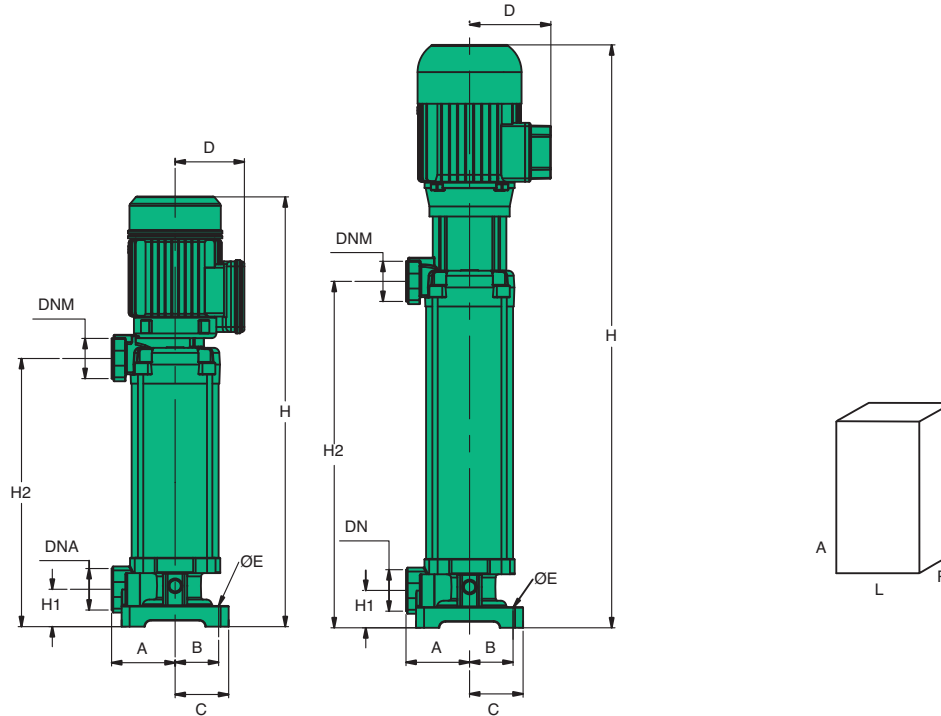

TIPO TYPE	DIMENSIONI [mm] DIMENSIONS [mm]										IMBALLO [mm] PACKING [mm]			PESO WEIGHT [kg]
	A	B	C	D	ØE	H	H1	H2	DNA	DNM	A	L	P	
MKV 3/7	97	67,5	86	104	10	580,8	37	313	1" 1/2	1" 1/4	800	207	256	24,3
MKV 3/9	97	67,5	86	104	10	629,5	37	362	1" 1/2	1" 1/4	1000	207	256	26,4
MKV 3/10	97	67,5	86	131,5	10	630	37	374	1" 1/2	1" 1/4	1000	207	256	30,5
MKV 3/12	97	67,5	86	131,5	10	677	37	423	1" 1/2	1" 1/4	1240	207	256	32,5
MKV 3/15	97	67,5	86	131,5	10	760	37	496	1" 1/2	1" 1/4	1240	207	256	35,5
MKV 3/17	97	67,5	86	131,5	10	810	37	544,5	1" 1/2	1" 1/4	1240	207	256	36,8
MKV 6/5	97	67,5	86	104	10	532,5	37	265	1" 1/2	1" 1/4	800	207	256	24,1
MKV 6/6	97	67,5	86	131,5	10	530	37	276,5	1" 1/2	1" 1/4	800	207	256	27,7
MKV 6/7	97	67,5	86	131,5	10	555	37	301	1" 1/2	1" 1/4	1000	207	256	29,3
MKV 6/9	97	67,5	86	131,5	10	616	37	350	1" 1/2	1" 1/4	1000	207	256	32,3
MKV 6/10	97	67,5	86	131,5	10	640	37	374	1" 1/2	1" 1/4	1000	207	256	32,5
MKV 6/12	97	67,5	86	131,5	10	873	37	423	1" 1/2	1" 1/4	1240	207	256	37,5
MKV 6/15	97	67,5	86	131,5	10	958	37	496	1" 1/2	1" 1/4	1240	207	256	40,5
MKV 6/17	97	67,5	86	131,5	10	1007	37	544,5	1" 1/2	1" 1/4	1240	207	256	42
MKV 9/4	97	67,5	86	104	10	566,5	37	300	1" 1/2	1" 1/4	800	207	256	23,5
MKV 9/5	97	67,5	86	131,5	10	560	37	327	1" 1/2	1" 1/4	800	207	256	27,3
MKV 9/6	97	67,5	86	131,5	10	630	37	371	1" 1/2	1" 1/4	800	207	256	28,5
MKV 9/7	97	67,5	86	131,5	10	670	37	415	1" 1/2	1" 1/4	1000	207	256	30,9
MKV 9/10	97	67,5	86	138,5	10	1000	37	547	1" 1/2	1" 1/4	1000	207	256	37,5
MKV 9/12	97	67,5	86	138,5	10	1080	37	635	1" 1/2	1" 1/4	1240	207	256	40,5
MKV 9/15	97	67,5	86	138,5	10	1200	37	767	1" 1/2	1" 1/4	1240	207	256	42
MKV 12/5	97	67,5	86	131,5	10	590	37	327	1" 1/2	1" 1/4	800	207	256	27,3
MKV 12/6	97	67,5	86	131,5	10	760	37	371	1" 1/2	1" 1/4	800	207	256	28,5
MKV 12/7	97	67,5	86	131,5	10	870	37	415	1" 1/2	1" 1/4	1000	207	256	36
MKV 12/10	97	67,5	86	131,5	10	1000	37	547	1" 1/2	1" 1/4	1240	207	256	42,5
MKV 12/12	97	67,5	86	131,5	10	1080	37	635	1" 1/2	1" 1/4	1240	207	256	45,5

min⁻¹ ~ 2900

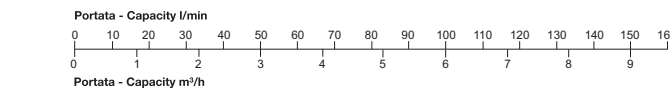
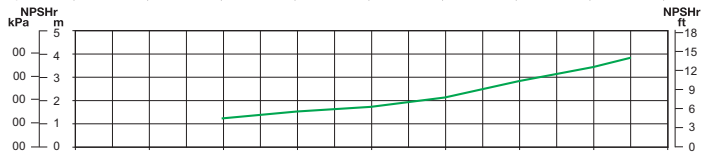
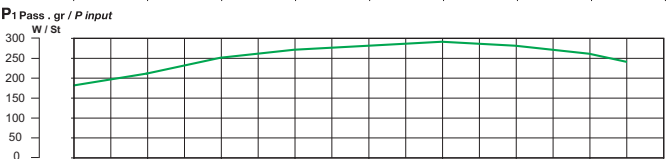
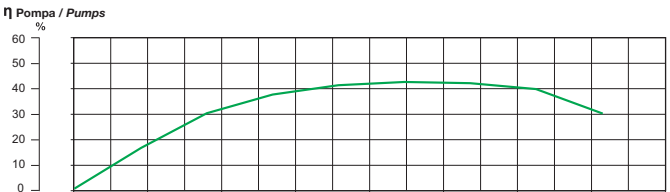
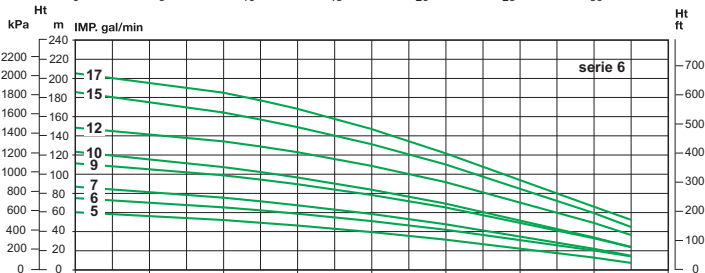
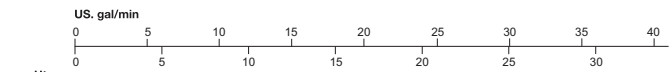
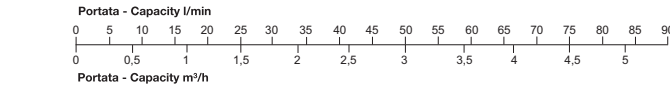
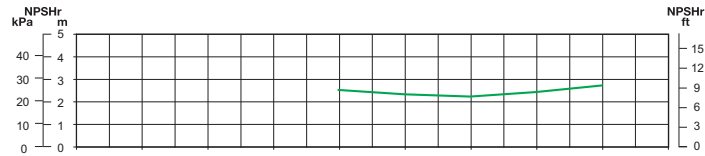
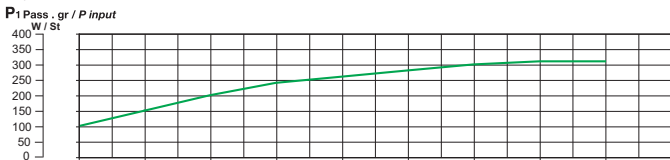
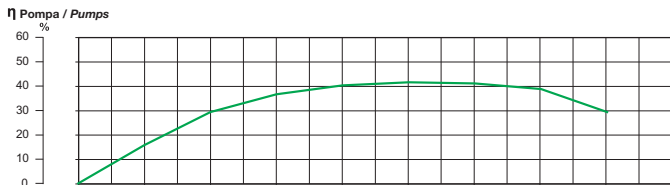
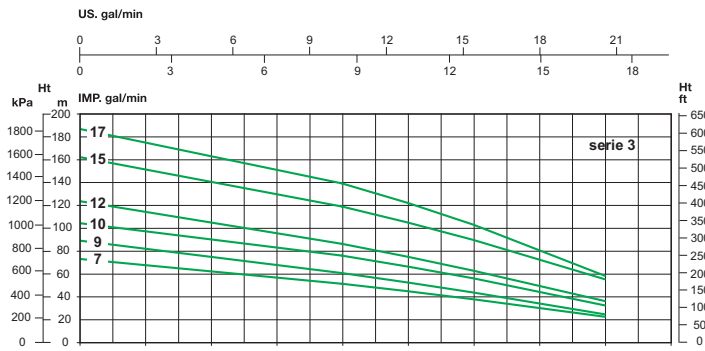

min⁻¹ ~ 3400

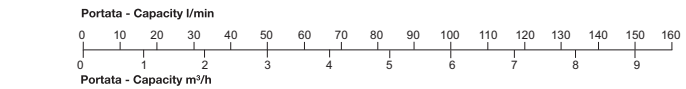
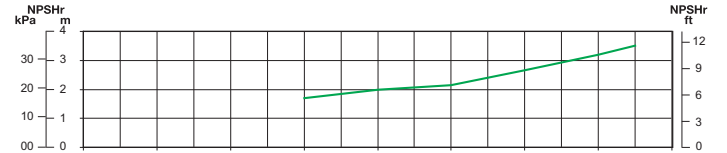
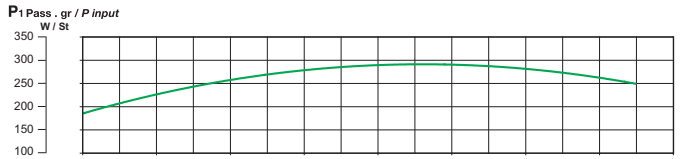
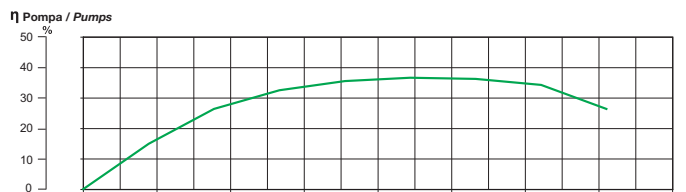
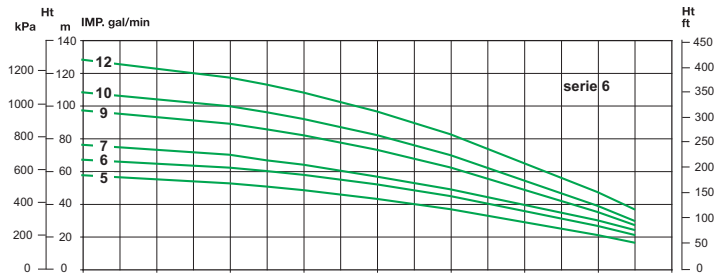
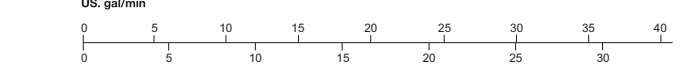
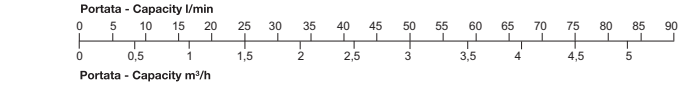
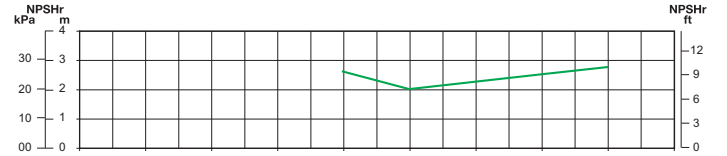
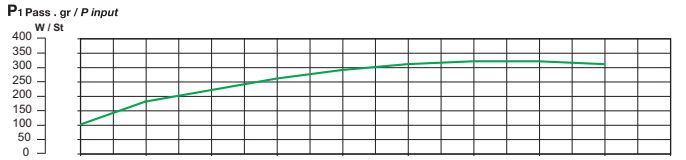
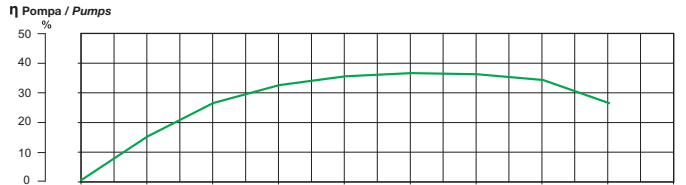
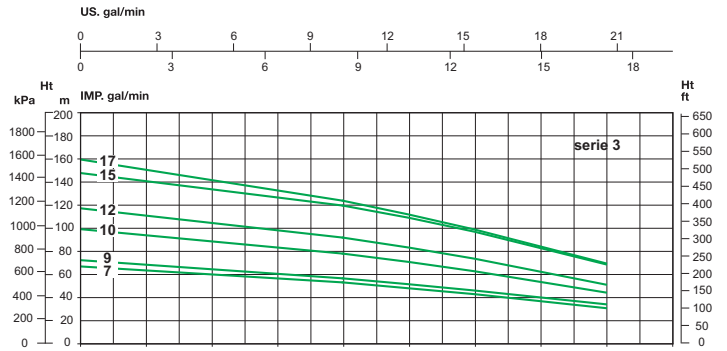

min⁻¹ ~ 2900

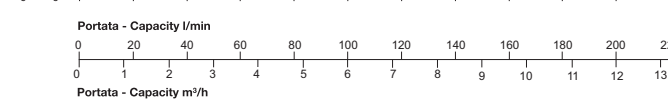
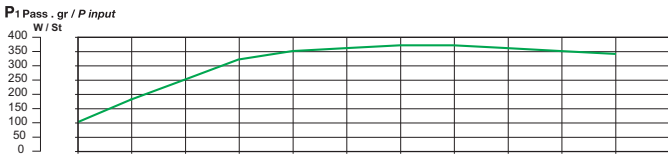
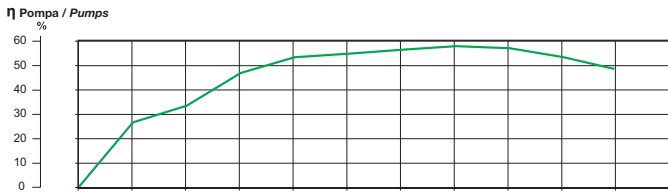
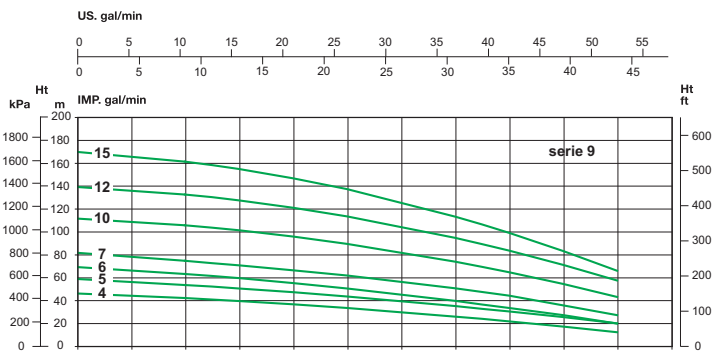

min⁻¹ ~ 3400

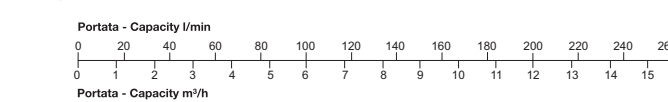
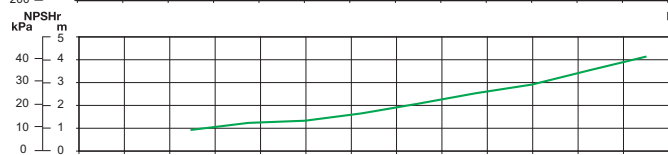
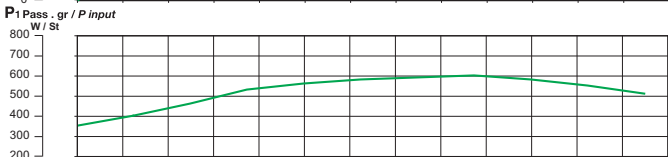
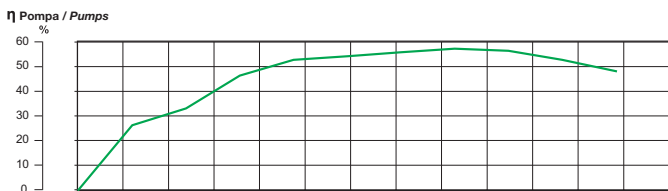
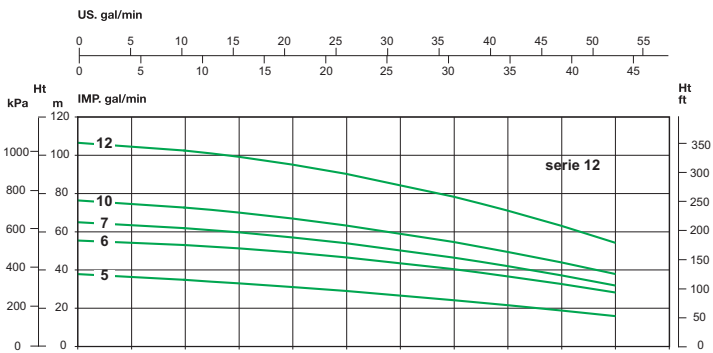
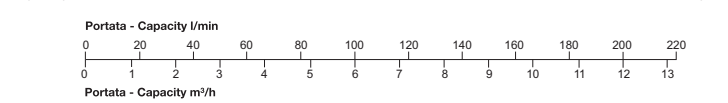
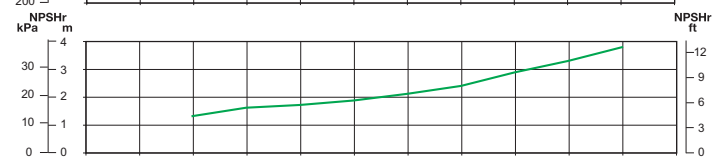
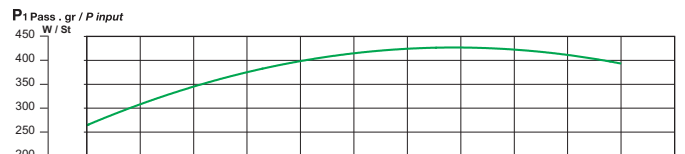
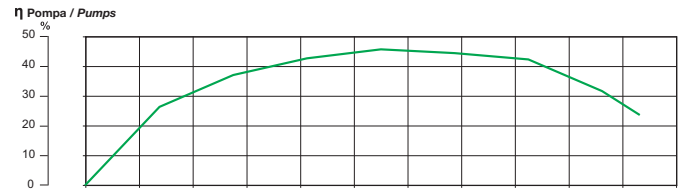
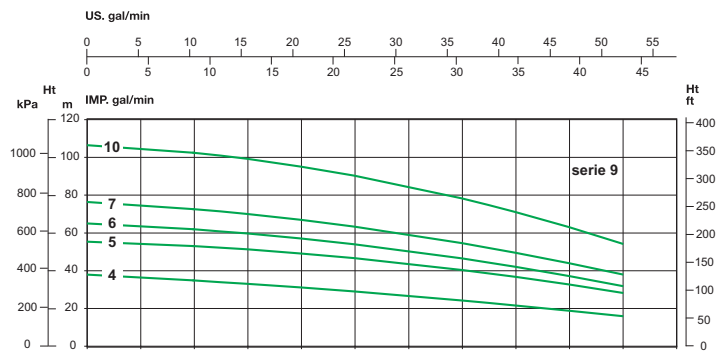

"MVX"



Cuore d'acciaio
Heart of steel
Coeur d'acier
Corazón de acero

NOMENCLATURA PARTI DI RICAMBIO
SPARE PARTS LIST
NOMENCLATURE PIECES DE RECHANGE
NOMENCLATURA REPUESTOS

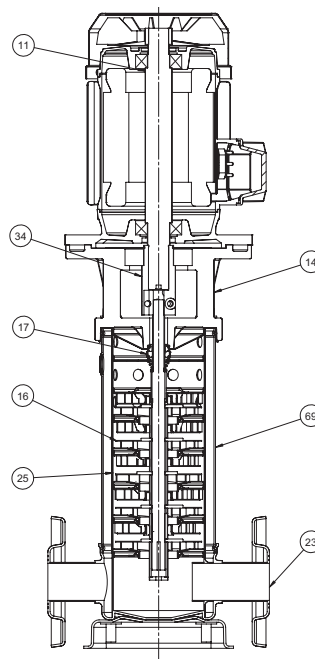

- 11** Albero con rotore – Pump shaft + rotor
Arbre + rotor – Eje rotor
- 14** Supporto mandata – Outlet bracket
Support envoyée – Soporte entrega
- 16** Girante – Impeller
Turbine – Impulsor
- 17** Tenuta meccanica – Mechanical seal
Garniture mécanique – Cierre mecánico
- 34** Giunto – Coupling
Manchon – Acoplamiento
- 23** Corpo flangia aspirante – Suction flange body
Corp bride aspirant – Cuerpo brida entrega
- 25** Diffusore – Diffuser
Diffuseur – Difusor
- 69** Camicia – Cover
Chemise – Camisa

TOP RANGE

Electric pumps

ELETTROPOMPE CENTRIFUGHE MULTISTADIO AD ASSE VERTICALE IN ACCIAIO INOX

Estremamente silenziose ed affidabili, le elettropompe centrifughe ad asse verticale multistadio della serie MVX sono state progettate per pompare liquidi puliti, senza parti abrasive, senza corpi solidi in sospensione, non esplosivi o aggressivi per i materiali della pompa

- Temperatura max. del liquido fino a 35 °C per uso domestico (CEI EN 60335-2-41) o 120 °C per altri usi e temperatura ambiente fino a 40 °C.
- Massima pressione di esercizio 27 bar
- Portate fino a ~ 25 m³/h.
- Prevalenze fino a ~ 250 m.

CARATTERISTICHE COSTRUTTIVE

- Supporto motore: ghisa G20 con trattamento anticorrosione
- Corpo pompa: in microfusione di acciaio inox Aisi 304
- Diffusori: in acciaio inox Aisi 304
- Giranti: in acciaio inox Aisi 304
- Albero pompa: acciaio inox Aisi 304
- Boccole: Carburo di tungsteno
- Tenuta meccanica: carbone-ceramica

MOTORE

I motori di comando sono del tipo asincrono a gabbia di scoiattolo chiusi, a ventilazione esterna

- Motoprotettore incorporato e condensatore permanentemente inserito per i tipi monofasi
- La protezione del motore nella versione trifase è a cura del cliente e si raccomandano apparecchiature in accordo con le norme vigenti
- Isolamento classe F –servizio S1- grado di protezione IP 44
- Protezione morsettiera IP 54

VERTICAL CENTRIFUGAL MULTISTAGE ELECTRIC PUMPS IN STAINLESS STEEL

Extremely noiseless and reliable the vertical centrifugal multistage electric pumps of the series MVX have been designed to pump clean liquids, without abrasives and suspended solids, non-explosive or aggressive for the pump's materials

- Liquid temperature not higher than 35 °C for domestic use (CEI EN 60335-2-41) or 120 °C for other use, while the ambient temperature must not be higher than 40 °C
- Maximum working pressure is 27 bar
- Flow rate up to ~ 25 m³/h
- Heads up to ~ 250 m

TECHNICAL FEATURES

- Motor bracket: cast iron G20 with anti-corrosive coating
- Diffusers: stainless steel Aisi 304
- Pump body: in precision-cast stainless steel Aisi 304
- Impellers: stainless steel Aisi 304
- Pump shaft: stainless steel Aisi 304
- Bushings: Tungsten carbide
- Mechanical seal: carbon-ceramics

MOTOR

The control motors are asynchronous, squirrel cage-type, closed, with external ventilation

- Incorporated motor protection and capacitor always on, for single-phase models
- The motor protection for three-phase models must be installed by the customer. Equipment compliant with current standards should be used
- Class of insulation:F-service:S1-Degree of protection: IP 44
- Terminal board protection: IP 54

ÉLETTROPOMPES CENTRIFUGES MULTISTADIO À AXE VERTICAL EN ACIER INOX

Extrêmement silencieuses et fiables, les électropompes centrifuges à axe vertical multistadio de la série MVX ont été conçues pour pomper des liquides propres, sans parties abrasives, sans corps liquides en suspension, non explosifs ou agressifs pour les matériaux de la pompe

- Température max. du liquide jusqu'à 35 °C pour utilisation domestique (CEI EN 60335-2-41) ou 120 °C pour d'autres utilisations et température ambiante jusqu'à 40 °C.
- Pression de service maximale 27 bars
- Plage d'utilisation jusqu'à ~ 25 m³/h.
- Hauteur manométrique jusqu'à ~ 250 m.

CARACTERISTIQUES DE CONSTRUCTION

- Lanterne: En fonte G20 avec traitement anti-corrosion
- Corps de pompe : moulage de précision d'acier inox Aisi 304
- Diffuseurs: en acier inox Aisi 304
- Turbine: en acier inox Aisi 304
- Abre de pompe: acier inox Aisi 304
- Douilles: Carbure de tungstène
- Garniture mécanique: Carbone dur - Céramique

MOTOR

Le moteurs sont asynchrones à cage d'écureuil fermés à ventilation extérieure monofasiques,

- Pour les modèles monophasés son avec protection thermique et condensateur connecté en permanence
- Pour les modèles triphasés, la protection est à la charge de l'utilisateur. A recommandé l'équipement conformément à la réglementation
- A Classe d'isolation F - service S 1 – protection IP44
- Protection IP54 dans le terminal

ELECTROBOMBAS CENTRÍFUGAS MULTIETAPA DE EJE VERTICAL EN ACERO INOX

Extremadamente silenciosas y fiables, las electrobombas centrifugas multietapa de eje vertical de la serie MVX han sido proyectadas para bombear líquidos limpios sin partes abrasivas, sin cuerpos sólidos en suspensión, que no sean explosivos ni agresivos para los materiales de la bomba.

- Temperatura max. del líquido hasta 35 °C para uso doméstico (CEI EN 60335-2-41) o 120 °C para otros usos y temperatura ambiente hasta 40 °C.
- Máxima presión de ejercicio 27 bar
- Caudal hasta ~ 25 m³/h.
- Alturas hasta ~ 250 m.

CARACTERÍSTICAS DE CONSTRUCCIÓN

- Soporte: Fundición gris G20 con tratamiento contra-corrosión
- Cuerpo de bomba: en fundición de acero inoxidable AISI 304
- Difusores: de acero Inox AISI 304
- Rodetes: de acero Inox AISI 304
- Eje de la bomba: de acero Inox AISI 304
- Bujes: Carburo de tungsteno
- Cierre mecánico: De cerámica y grafito

MOTOR

Los motores de accionamiento son asíncrono de jaula de ardilla cerrados, ventilados externamente

- Para los modelos monofásicos, protección térmica y condensador incorporado
- Para los modelos trifásicos de la protección se encarga el usuario y el equipo recomendado de acuerdo con las normas
- Aislamiento de Clase F – funcionamiento S1- protección IP44
- Protección IP54 para el terminal

50 Hz - min⁻¹ ~ 2900

TIPO TYPE		Potenza nominale Nominal power[A]		Portata - Capacity																					
Monofase Single-phase	Trifase Three-phase	kW	HP	Prevalenza (m C.A.) Total head (m W.C.)																					
				Q [m³/h]	Q [l/s]	0	1,5	1,98	2,52	3	3,48	4,02	4,5	4,98	5,4	6	7,02	7,98	9	10,02	10,98	13,98	18	19,98	22,02
MXV 3-6 FM	MXV 3-6 FT	1,1	1,5	67,8	60,6	57,1	52,8	47,9	42,7	36,8	30,4														
MXV 3-7 FM	MXV 3-7 FT	1,1	1,5	78,6	69,8	65,6	60,5	54,8	48,6	41,8	34,3														
MXV 3-8 FM	MXV 3-8 FT	1,5	2,0	91	81,7	77	71,4	64,9	57,9	50,2	41,6														
MXV 3-10 FM	MXV 3-10 FT	1,5	2,0	112,7	100,4	94,4	87,1	78,9	70,1	60,4	49,7														
MXV 3-12 FM	MXV 3-12 FT	2,2	3,0	137,2	123,7	116,8	108,3	98,7	88,3	76,6	63,6														
MXV 3-14 FM	MXV 3-14 FT	2,2	3,0	159,3	142,8	134,6	124,6	113,3	101,1	87,4	72,4														
-	MXV 3-17 F	3,0	4,0	194,3	174,7	164,8	152,7	139,1	124,3	107,7	89,4														
-	MXV 3-20 F	4,0	5,5	231,6	210,5	199,4	185,7	169,8	152,6	133,2	111,6														
-	MXV 3-22 F	4,0	5,5	254,2	230,6	218,3	203,1	185,5	166,6	145,3	121,5														
MXV 5-5 FM	MXV 5-5 FT	1,1	1,5	56,3		52,1	50,7	49,2	47,6	45,8	43,8	41,6	39,4	36,1	28,8										
MXV 5-7 FM	MXV 5-7 FT	1,5	2,0	79,3		73,5	71,6	69,5	67,3	64,7	62	58,9	55,9	51,2	41										
MXV 5-8 FM	MXV 5-8 FT	2,2	3,0	92		86,1	84,1	82	79,6	76,9	73,9	70,4	67,2	61,8	50,5										
MXV 5-10 FM	MXV 5-10 FT	2,2	3,0	114,1		106,3	103,7	100,8	97,8	94,2	90,4	86	81,9	75,2	60,8										
-	MXV 5-12 FT	3,0	4,0	137,6		128,4	125,4	122,1	118,5	114,3	109,7	104,4	99,6	91,6	74,5										
-	MXV 5-14 FT	3,0	4,0	159,7		148,4	144,7	140,7	136,4	131,4	126	119,8	114	104,6	84,5										
-	MXV 5-17 FT	4,0	5,5	196,5		184,3	180,3	175,8	170,9	165,2	158,8	151,5	144,8	133,5	109,7										
-	MXV 5-19 FT	5,5	7,5	220		206,5	202,1	197,1	191,8	185,4	178,4	170,2	162,7	150,2	123,6										
-	MXV 5-22 FT	5,5	7,5	253,8		237,7	232,4	226,5	220,1	212,6	204,4	194,8	186,1	171,4	140,4										
MXV 9-5 FM	MXV 9-5 FT	2,2	3,0	59,9						55,6	55,1	54,5	54	53	51,2	49,4	47,4	44,7	41	24,8					
MXV 9-6 FM	MXV 9-6 FT	2,2	3,0	71,5						66,1	65,4	64,7	63,9	62,7	60,5	58,3	55,9	52,5	48	28,6					
-	MXV 9-7 FT	3,0	4,0	83,9						77,7	77	76,2	75,4	74	71,4	68,9	66,2	62,3	57,1	34,4					
-	MXV 9-8 FT	3,0	4,0	95,5						88,1	87,3	86,3	85,3	83,6	80,7	77,7	74,6	70,1	64,1	38,1					
-	MXV 9-10 FT	4,0	5,5	120,4						112,4	111,5	110,4	109,3	107,4	103,9	100,3	96,5	91,2	84	51,5					
-	MXV 9-12 FT	5,5	7,5	144,6						134,9	133,8	132,5	131,1	128,8	124,7	120,3	115,8	109,4	100,7	61,8					
-	MXV 9-14 FT	5,5	7,5	168,2						156,2	154,9	153,3	151,7	148,9	143,9	138,8	133,5	125,8	115,6	70,2					
-	MXV 9-17 FT	7,5	10,0	205						191,2	189,8	187,9	186	182,7	176,8	170,7	164,4	155,3	143,1	87,9					
-	MXV 9-20 FT	7,5	10,0	240,3						223,4	221,5	219,2	216,9	212,9	205,9	198,6	190,9	180	165,4	100,6					
-	MXV 16-4 FT	3,0	4,0	48,2												44,3	43,5	42,6	41,7	39,1	35,2	31,5	26,7	18,1	
-	MXV 16-5 FT	4,0	5,5	60,8												56,5	55,5	54,5	53,5	50,3	45,5	41,2	35,2	24,5	
-	MXV 16-6 FT	5,5	7,5	73												67,8	66,6	65,4	64,2	60,3	54,6	49,4	42,2	29,3	
-	MXV 16-7 FT	5,5	7,5	84,9												78,5	77,1	75,7	74,2	69,7	62,9	56,7	48,3	33,3	
-	MXV 16-8 FT	5,5	7,5	96,7												89,1	87,5	85,8	84,1	78,8	71	63,8	54,2	37,1	
-	MXV 16-9 FT	7,5	10,0	109,4												101,5	99,7	97,9	96,1	90,3	81,7	73,9	63,1	43,8	
-	MXV 16-10 FT	7,5	10,0	121,3												112,3	110,2	108,2	106,1	99,7	90	81,2	69,2	47,8	
-	MXV 16-11 FT	7,5	10,0	133,1												122,9	120,6	118,4	116,1	108,9	98,2	88,3	75,1	51,6	
-	MXV 16-12 FT	9,2	12,5	145,5												134,7	132,2	129,8	127,3	119,5	108	97,4	82,9	57,2	
-	MXV 16-13 FT	9,2	12,5	157,3												145,3	142,6	139,9	137,2	128,7	116,1	104,5	88,9	61,1	
-	MXV 16-14 FT	11,0	15,0	171,3												160,9	158,2	155,5	152,7	143,9	130,9	119,2	102,5	72,5	
-	MXV 16-15 FT	11,0	15,0	183,4												172	169,1	166,1	163,2	153,7	139,8	127,1	109,2	77,1	
-	MXV 16-16 FT	11,0	15,0	195,5												183,1	179,9	176,8	173,6	163,5	148,6	135	115,9	81,6	

MOTOR TYPE		IEC SIZE	INPUT CURRENT A SINGLE-PHASE			Noise Lpa/dB	MOTOR 230V - 50Hz				
kW	HP	MEC	230V			70	min ⁻¹	ls/lm	Cos φ	Nm	Ts/Tn
1,1	1,50	80	7,50	-	-	70	2830	6,78	0,94	3,70	3,49
1,5	2,00	90	9,30	-	-	70	2835	7,44	0,90	5,10	3,08
2,2	3,00	100	12,80	-	-	70	2795	9,36	0,98	7,50	3,98

MOTOR TYPE		IEC SIZE	INPUT CURRENT A THREE-PHASE			Noise Lpa/dB	MOTOR 400V - 50Hz				
kW	HP	MEC	230V	400V	690V	70	min ⁻¹	ls/lm	Cos φ	Nm	Ts/Tn
1,1	1,5	80	4,6	2,7	-	70	2875	6,78	0,77	3,65	3,49
1,5	2	90	5,3	3	-	70	2885	7,44	0,85	4,97	3,08
2,2	3	90	8,1	4,7	-	70	2890	8,3	0,79	7,3	3,72
3	4	100	10	5,8	-	70	2910	9,36	0,85	9,84	3,98
4	5,5	112	16	7,6	-	71	2890	8,62	0,87	13,2	3,5
5,5	7,5	132	-	10,7	6,2	71	2935	9,82	0,83	17,9	3,47
7,5	10	132	-	13,9	8	71	2925	9,52	0,87	24,5	3,24
9,2	12,5	132	-	17	9,3	71	2920	8,72	0,88	28,6	2,14
11	15	160	-	20	11,5	73	2940	7,59	0,89	35,7	2,11

EFFICIENCY CLASSES OF MOTOR - IE CODE 50 Hz

Output kW	IE1 code Standard Efficiency		IE2 code Standard Efficiency		IE3 code Standard Efficiency	
	2 poles	4 poles	2 poles	4 poles	2 poles	4 poles
1,1	75,00	75,00	79,60	81,40	82,70	84,10
1,5	77,20	77,20	81,30	82,80	84,20	85,30
2,2	79,70	79,70	83,20	84,30	85,90	86,70
3,0	81,50	81,50	84,60	85,50	87,10	87,70
4,0	83,10	83,10	85,80	86,60	88,10	88,60
5,5	84,70	84,70	87,00	87,70	89,20	89,60
7,5	86,00	86,00	88,10	88,70	90,10	90,40
11,0	87,60	87,60	89,40	89,80	91,20	91,40

60 Hz - min⁻¹ ~ 3400

TIPO TYPE		Potenza nominale Nominal power[A]		Portata - Capacity																					
Monofase Single-phase	Trifase Three-phase	kW	HP	Q [m ³ /h]	0	1,5	1,98	2,52	3	3,48	4,02	4,5	4,98	5,4	6	7,02	7,98	9	10,02	10,98	13,98	18	19,98	22,02	25,02
				Q [l/v ¹]	0	25	33	42	50	58	67	75	83	90	100	117	133	150	167	183	233	300	333	367	417
				Prevalenza (m C.A.) Total head (m W.C.)																					
a	b			H [m]																					
MVX 3-4 FM	MVX 3-4 FT	1,1	1,5	64,5	59,5	56,5	53,5	50	46	40	37,5	34,5	27												
MVX 3-5 FM	MVX 3-5 FT	1,5	2,0	81,5	76	72	68	63,5	59	51,5	48	44,5	35,5												
MVX 3-6 FM	MVX 3-6 FT	1,5	2,0	97	89	85	80	75	69	60	56	52	41												
MVX 3-7 FM	MVX 3-7 FT	2,2	3,0	115,5	106,5	102	97	91	84	74	70	64,5	51,5												
MVX 3-8 FM	MVX 3-8 FT	2,2	3,0	131	120	115,5	109,5	102,5	95	83,5	77,5	72	57,5												
	MVX 3-9 FT	3,0	4,0	148,5	137,5	131,5	125	117,5	108,5	95,5	90	83	67												
	MVX 3-10 FT	3,0	4,0	164,5	152	145	138	129	119,5	105	98,5	91	73												
	MVX 3-11 FT	3,0	4,0	180,5	165	158,5	150,5	141	130	114	107	98,5	79												
	MVX 3-12 FT	3,0	4,0	196	180	172	162,5	152	140,5	123	115	106	84,5												
	MVX 3-13 FT	4,0	5,5	216	200	192,5	183,5	172,5	160,5	141,5	132,5	123,5	99,5												
	MVX 3-14 FT	4,0	5,5	232,5	215	207	197	185	171,5	151,5	142	132	106,5												
	MVX 3-15 FT	4,0	5,5	248,5	230	220,5	210	197	183	161,5	150,5	140,5	113												
MVX 5-3 FM	MVX 5-3 FT	1,1	1,5	48,5			44,5	43,5	42,5	41	40	39,5	37,5	35,5	31										
MVX 5-4 FM	MVX 5-4 FT	1,5	2,0	65,5			60,5	59	57,5	55,5	54,5	53,5	50,5	48,5	42,5										
MVX 5-5 FM	MVX 5-5 FT	2,2	3,0	82,5			77	75,5	73,5	71,5	70	69	65,5	63	55										
MVX 5-6 FM	MVX 5-6 FT	2,2	3,0	98,5			91	89,5	87,5	84,5	82,5	81	77	74	64,5										
	MVX 5-7 FT	3,0	4,0	115,5			107,5	105,5	103	99,5	98	96	91,5	87,5	77										
	MVX 5-8 FT	3,0	4,0	131,5			122	119	116,5	112,5	110	108	103	98,5	86										
	MVX 5-10 FT	4,0	5,5	166,5			155,5	152,5	149,5	144,5	142,3	140	133,5	128	113										
	MVX 5-12 FT	5,5	7,5	199,5			186,5	183	179,5	173,5	170,7	167,5	160	154	135,5										
	MVX 5-13 FT	5,5	7,5	216			201,5	197,5	193,5	187	183,6	180,5	172,5	165,5	145,5										
	MVX 5-14 FT	5,5	7,5	232			216	212	207,5	200,5	197	193,5	184,5	177	155,5										
	MVX 5-15 FT	7,5	10,0	250,5			234,5	230,5	225,5	218,5	214,3	211,5	202	194,5	171,5										
	MVX 9-4 FT	3,0	4,0	69								64	63,5	62,5	61	60	58	56	54,5	44					
	MVX 9-5 FT	3,0	4,0	85,5								79	78	77	75	73	71	68,5	66,5	52,5					
	MVX 9-6 FT	4,0	5,5	104								97	96	95	92,5	90	88,5	85,5	83	67					
	MVX 9-7 FT	5,5	7,5	121,5								113	112	111	108	105	103	100	97	79					
	MVX 9-8 FT	5,5	7,5	138,5								128,5	127,5	126	122,5	120	116,5	113	110	88					
	MVX 9-9 FT	7,5	10,0	156,5								146,5	145	144	140	137	134	129,5	126	102,5					
	MVX 9-10 FT	7,5	10,0	173,5								162	160,5	159	154,5	151	147	143	139	112,5					
	MVX 9-11 FT	7,5	10,0	190,5								177,5	175,5	174	169	165	160,5	156	151,5	123					
	MVX 9-12 FT	7,5	10,0	207,5								192,5	190,5	189	183,5	179	174	169	164	132					
	MVX 9-13 FT	11,0	15,0	225,5								209,5	207,5	206	200	195	190	184,5	179,5	145					
	MVX 9-14 FT	11,0	15,0	242								225	223	220,5	214,5	210	204	197,5	192	155					
	MVX 16-3 FT	4,0	5,5	52,5													48,5	48	46	42,5	40	38	33		
	MVX 16-4 FT	5,5	7,5	70													64,5	63,5	61	56,5	54	50	44		
	MVX 16-5 FT	7,5	10,0	87,5													81	80	76,5	72	68	64	55,5		
	MVX 16-6 FT	7,5	10,0	104,5													96	95	90	85	81	76	65		
	MVX 16-7 FT	11,0	15,0	122													112,5	111	105	98	95	88,5	77		
	MVX 16-8 FT	11,0	15,0	139													127,5	126	120	112	106,5	100	86,5		
	MVX 16-9 FT	11,0	15,0	158,5													147,5	146	139	130	125	117,5	104,5		

MOTOR TYPE MOTOR TYPE		IEC SIZE	INPUT CURRENT A SINGLE-PHASE		Noise Lpa/dB	MOTOR 220V - 60Hz				
kW	HP	MEC	220V	380V	70	min ⁻¹	ls/lm	Cos φ	Nm	Ts/Tn
1,10	1,50	80	8,00	-	70	3420	6,78	0,94	3,70	3,49
1,50	2,00	90	9,80	-	70	3435	7,44	0,90	5,10	3,08
2,20	3,00	100	13,40	-	70	3480	9,36	0,98	7,50	3,98

MOTOR TYPE MOTOR TYPE		IEC SIZE	INPUT CURRENT A THREE-PHASE		Noise Lpa/dB	MOTOR 380V - 60Hz				
kW	HP	MEC	220V	380V	70	min ⁻¹	ls/lm	Cos φ	Nm	Ts/Tn
1,1	1,5	80	4,2	2,5	70	3420	6,26	0,88	3,07	2,52
1,5	2	90	5,8	3,3	70	3435	5,14	0,89	4,17	1,71
2,2	3	90	7,9	4,6	70	3445	7,23	0,89	6,11	2,79
3	4	100	10,5	6	70	3480	7,1	0,89	8,36	2,96
4	5,5	112	13	7,7	71	3475	7,2	0,93	11,1	2,46
5,5	7,5	132,0	18,3	10,6	71	3465	8,09	0,91	14,9	2,48
7,5	10	132	24	14	71	3505	7,54	0,91	20,4	2,31
9,2	12,5	132	31	18	71	3520	5,9	0,91	26	2,2
11	15	160	35	21	73	3520	6,04	0,92	29,9	1,6

EFFICIENCY CLASSES OF MOTOR - IE CODE 60 Hz

Output kW	IE1 code Standard Efficiency		IE2 code Standard Efficiency		IE3 code Standard Efficiency	
	2 poles	4 poles	2 poles	4 poles	2 poles	4 poles
1,1	78,50	79,00	82,50	84,00	84,00	86,50
1,5	81,00	81,50	84,00	84,00	85,50	86,50
2,2	81,50	83,00	85,50	87,50	86,50	89,50
3,0	84,5	85,0	87,5	87,5	88,5	89,5
4,0	84,50	85,00	87,50	87,50	88,50	89,50
5,5	86,00	87,00	88,50	89,50	89,50	91,70
7,5	87,50	87,50	89,50	89,50	90,20	91,70
11,0	87,50	88,50	90,20	91,00	91,00	92,40

50 Hz - min⁻¹ ~ 2900

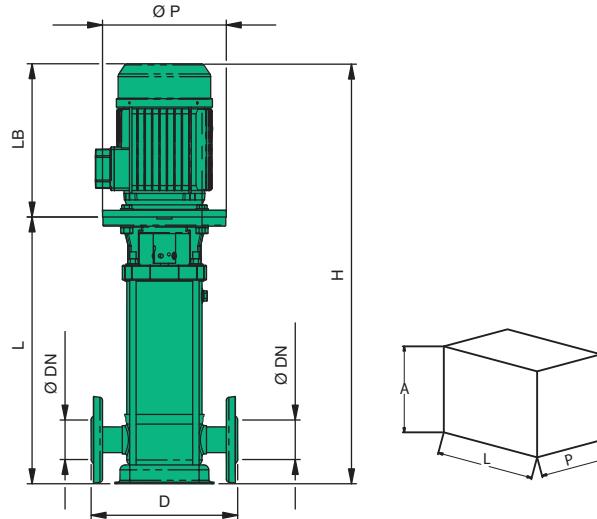

TIPO TYPE	DIMENSIONI IDRAULICA [mm] HYDRAULIC DIMENSIONS [mm]			MOTORE [mm] MOTOR [mm]		IMBALLO [mm] PACKING [mm]			PESO WEIGHT [kg]	
	D	L	DN	LB	ØP	H	A	L		P
MVX 3-6 FT	250	425	25	232	B14	657	737	310	310	29
MVX 3-7 FT	250	449	25	232	B14	681	761	310	310	29,5
MVX 3-8 FT	250	483	25	267	B14	750	830	310	310	33
MVX 3-10 FT	250	531	25	267	B14	798	878	310	310	34,5
MVX 3-12 FT	250	579	25	267	B14	846	926	310	310	37,5
MVX 3-14 FT	250	627	25	267	B14	894	974	310	310	39
MVX 3-17 F	250	709	25	306	B14	1015	1095	310	310	48
MVX 3-20 F	250	781	25	328	B14	1109	1189	310	310	60,5
MVX 3-22 F	250	829	25	328	B14	1157	1237	310	310	62
MVX 5-5 FT	250	400,5	32	232	B14	632,5	712,5	310	310	285
MVX 5-7 FT	250	459	32	267	B14	726	806	310	310	33
MVX 5-8 FT	250	483	32	267	B14	750	830	310	310	35,5
MVX 5-10 FT	250	531	32	267	B14	798	878	310	310	36,5
MVX 5-12 FT	250	589	32	306	B14	895	975	310	310	45,5
MVX 5-14 FT	250	637	32	306	B14	943	1023	310	310	47
MVX 5-17 FT	250	709	32	328	B14	1037	1117	310	310	59
MVX 5-19 FT	250	779,5	32	362	B5	1141,5	1221,5	310	310	78
MVX 5-22 FT	250	851,5	32	362	B5	1213,5	1293,5	310	310	79,5
MVX 9-5 FT	280	448	40	267	B14	715	795	310	310	36
MVX 9-6 FT	280	478	40	267	B14	745	825	310	310	37
MVX 9-7 FT	280	518	40	306	B14	824	904	310	310	45
MVX 9-8 FT	280	548	40	306	B14	854	934	310	310	34
MVX 9-10 FT	280	608	40	328	B14	936	1016	310	310	58
MVX 9-12 FT	280	690,5	40	362	B5	1052,5	1132,5	310	310	76,5
MVX 9-14 FT	280	750,5	40	362	B5	1112,5	1192,5	310	310	78
MVX 9-17 FT	280	840,5	40	362	B5	1202,5	1282,5	310	310	87,5
MVX 9-20 FT	280	930,5	40	362	B5	1292,5	1372,5	310	310	89,5
MVX 16-4 FT	300	467,5	50	306	B14	773,5	853,5	310	310	44,5
MVX 16-5 FT	300	505	50	328	B14	833	913	310	310	56
MVX 16-6 FT	300	565	50	362	B5	927	1007	310	310	74,5
MVX 16-7 FT	300	602,5	50	362	B5	964,5	1044,5	310	310	75,5
MVX 16-8 FT	300	640	50	362	B5	1002	1082	310	310	76,5
MVX 16-9 FT	300	677,5	50	362	B5	1039,5	1119,5	310	310	84,5
MVX 16-10 FT	300	715,5	50	362	B5	1077,5	1157,5	310	310	85,5
MVX 16-11 FT	300	753	50	362	B5	1115	1195	310	310	86,5
MVX 16-12 FT	300	790,5	50	420	B5	1210,5	1290,5	310	310	87,5
MVX 16-13 FT	300	828	50	420	B5	1248	1328	310	310	88
MVX 16-14 FT	300	865,5	50	420	B5	1285,5	1365,5	310	310	89
MVX 16-15 FT	300	903	50	420	B5	1323	1403	310	310	90
MVX 16-16 FT	300	940,5	50	420	B5	1360,5	1440,5	310	310	91

60 Hz - min⁻¹ ~ 3400

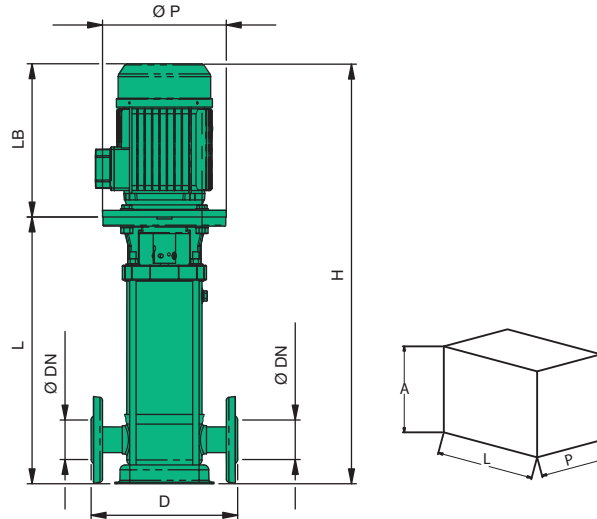

TIPO TYPE	DIMENSIONI IDRAULICA [mm] HYDRAULIC DIMENSIONS [mm]			MOTORE [mm] MOTOR [mm]		IMBALLO [mm] PACKING [mm]			PESO WEIGHT [kg]	
	D	L	DN	LB	ØP	H	A	L		P
MVX 3-4 FT	250	376,5	25	232	B14	608,5	688,5	310	310	27,5
MVX 3-5 FT	250	410,5	25	267	B14	677,5	757,5	310	310	31
MVX 3-6 FT	250	435	25	267	B14	702	782	310	310	32
MVX 3-7 FT	250	459	25	267	B14	726	806	310	310	34,5
MVX 3-8 FT	250	483	25	267	B14	750	830	310	310	35
MVX 3-9 FT	250	517	25	306	B14	823	903	310	310	43,5
MVX 3-10 FT	250	541	25	306	B14	847	927	310	310	44
MVX 3-11 FT	250	565	25	306	B14	871	951	310	310	44,5
MVX 3-12 FT	250	589	25	306	B14	895	975	310	310	45
MVX 3-13 FT	250	613	32	328	B14	941	1021	310	310	56,5
MVX 3-14 FT	250	637	32	328	B14	965	1045	310	310	57
MVX 3-15 FT	250	661	32	328	B14	989	1069	310	310	57,5
MVX 5-3 FT	250	352,5	32	232	B14	584,5	664,5	310	310	27,5
MVX 5-4 FT	250	386,5	32	267	B14	653,5	733,5	310	310	31
MVX 5-5 FT	250	410,5	32	267	B14	677,5	757,5	310	310	33,5
MVX 5-6 FT	250	435	32	267	B14	702	782	310	310	34
MVX 5-7 FT	250	469	32	306	B14	775	855	310	310	42,5
MVX 5-8 FT	250	493	32	306	B14	799	879	310	310	43
MVX 5-10 FT	250	541	40	328	B14	869	949	310	310	54,5
MVX 5-12 FT	250	611,5	40	362	B5	973,5	1053,5	310	310	73,5
MVX 5-13 FT	250	635,5	40	362	B5	997,5	1077,5	310	310	74
MVX 5-14 FT	250	659,5	40	362	B5	1021,5	1101,5	310	310	74,5
MVX 5-15 FT	250	683,5	40	362	B5	1045,5	1125,5	310	310	82
MVX 9-4 FT	280	427,5	40	306	B14	733,5	813,5	310	310	43
MVX 9-5 FT	280	458	40	306	B14	786	866	310	310	43,5
MVX 9-6 FT	280	488	40	328	B14	850	930	310	310	55
MVX 9-7 FT	280	540,5	40	362	B5	902,5	982,5	310	310	73
MVX 9-8 FT	280	570,5	50	362	B5	932,5	1012,5	310	310	73,5
MVX 9-9 FT	280	600,5	50	362	B5	962,5	1042,5	310	310	81,5
MVX 9-10 FT	280	630,5	50	362	B5	992,5	1072,5	310	310	82
MVX 9-11 FT	280	660,5	50	362	B5	1022,5	1102,5	310	310	83
MVX 9-12 FT	280	690,5	50	362	B5	1110,5	1190,5	310	310	83,5
MVX 9-13 FT	280	720,5	50	420	B5	1140,5	1220,5	310	310	83,5
MVX 9-14 FT	280	750,5	50	420	B5	1170,5	1250,5	310	310	84,5
MVX 16-3 FT	300	430	50	328	B14	758	838	310	310	54
MVX 16-4 FT	300	490	50	362	B5	852	932	310	310	72,5
MVX 16-5 FT	300	527,5	50	362	B5	889,5	969,5	310	310	80,5
MVX 16-6 FT	300	565	50	362	B5	927	1007	310	310	81,5
MVX 16-7 FT	300	602,5	50	420	B5	1022,5	1102,5	310	310	82,5
MVX 16-8 FT	300	640	50	420	B5	1060	1140	310	310	83,5
MVX 16-9 FT	300	677,5	50	420	B5	1097,5	1177,5	310	310	84,5

min⁻¹ ~ 2900

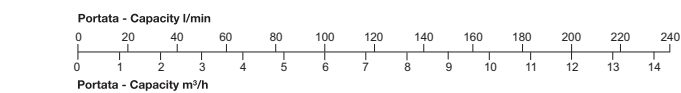
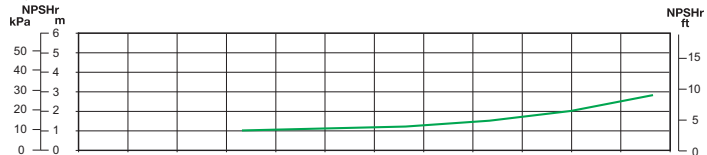
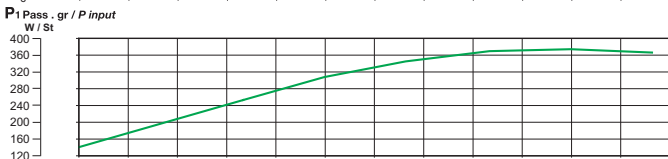
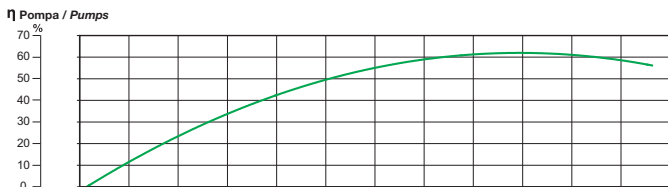
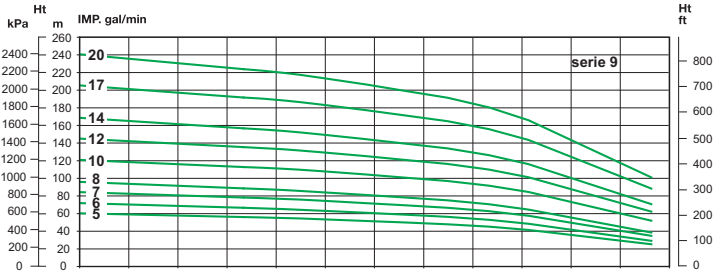
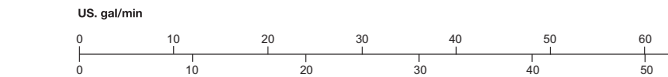
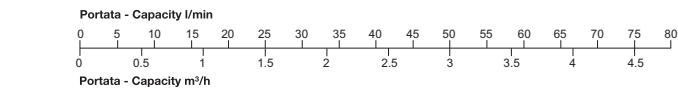
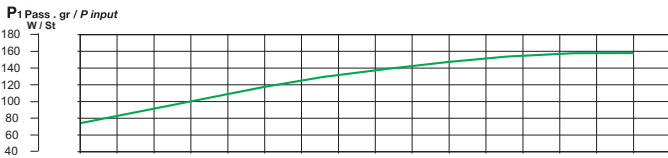
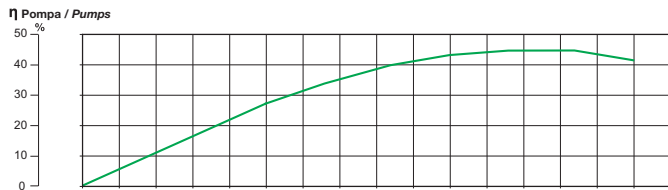
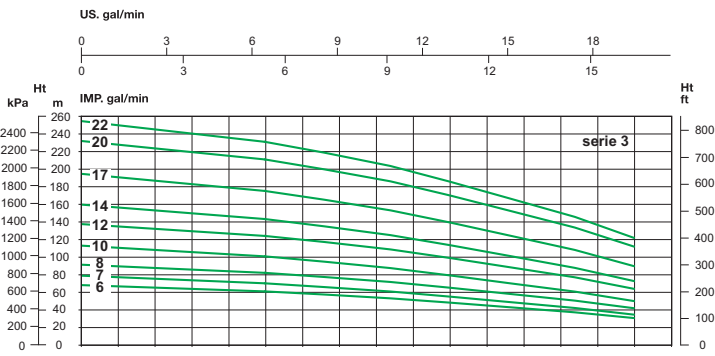

min⁻¹ ~ 3400

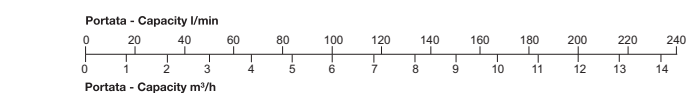
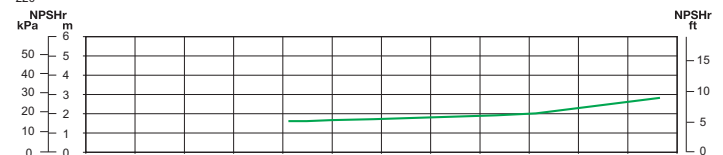
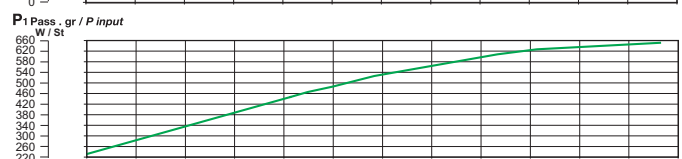
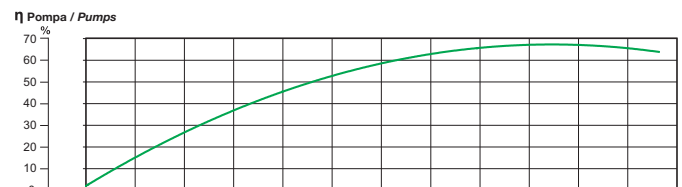
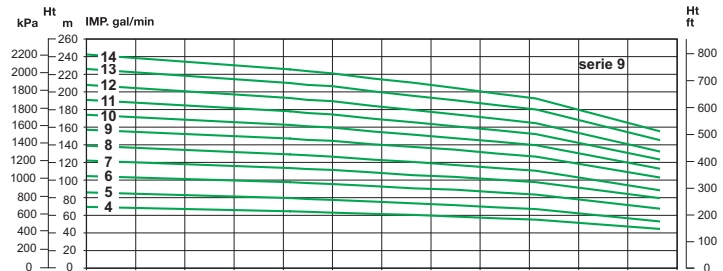
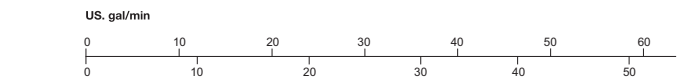
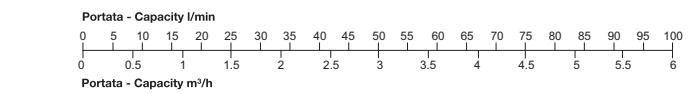
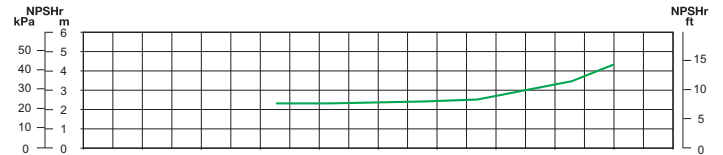
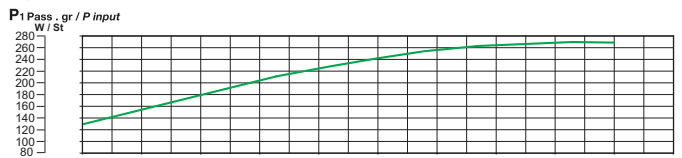
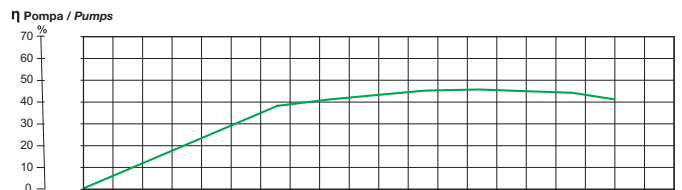
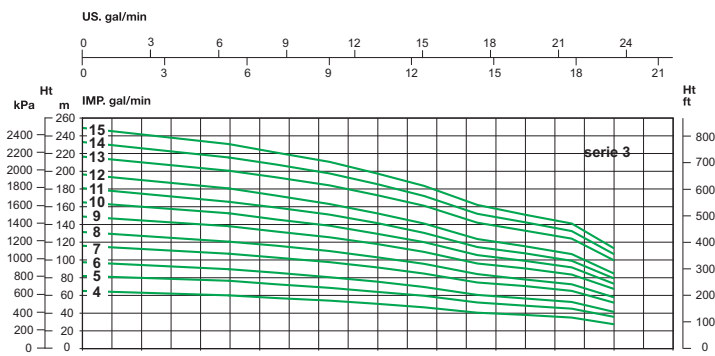

min⁻¹ ~ 2900

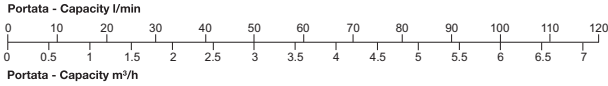
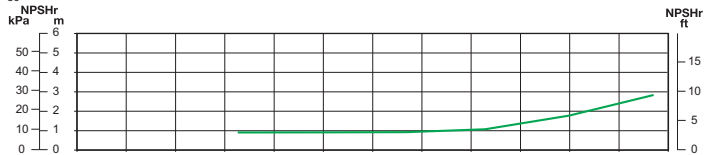
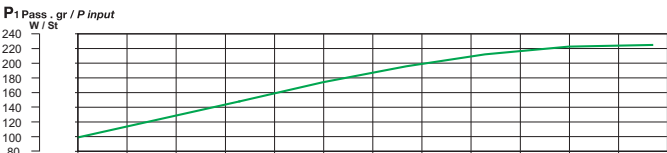
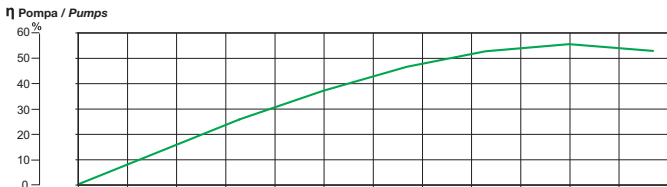
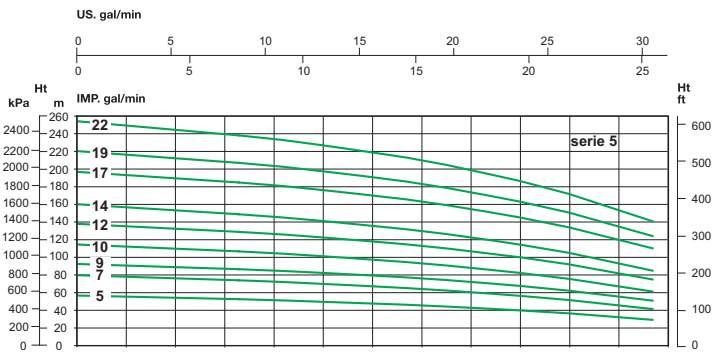

min⁻¹ ~ 3400

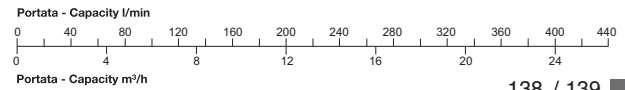
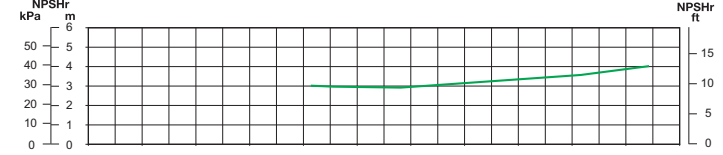
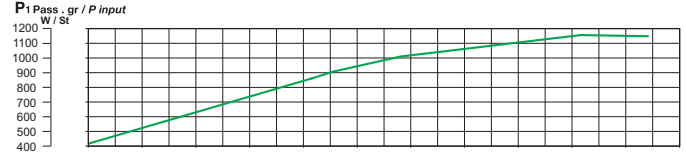
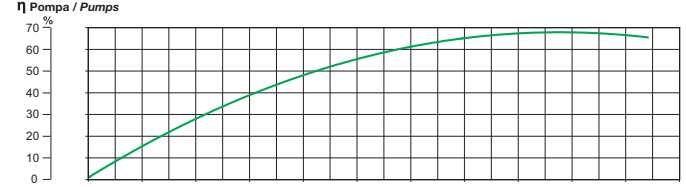
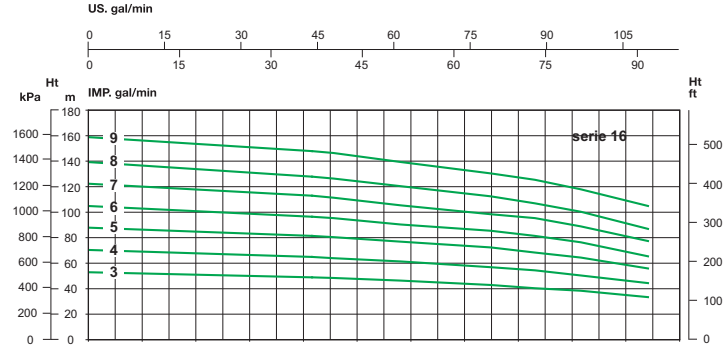
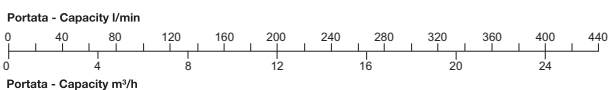
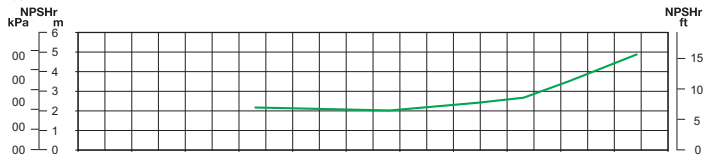
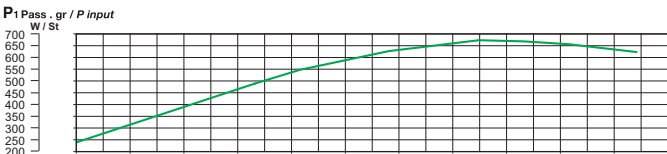
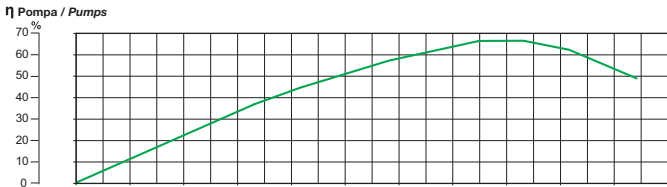
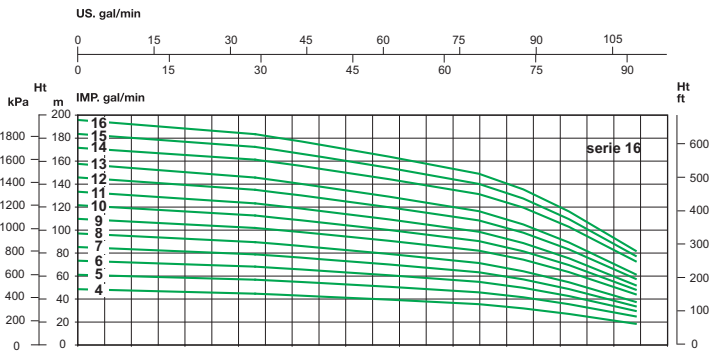
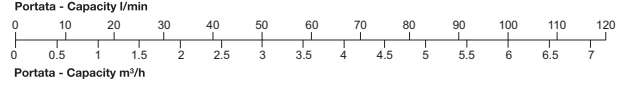
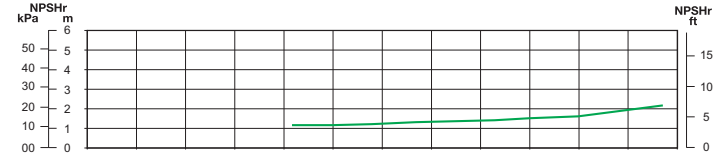
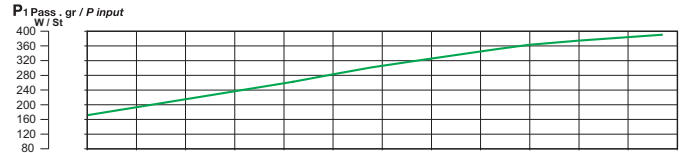
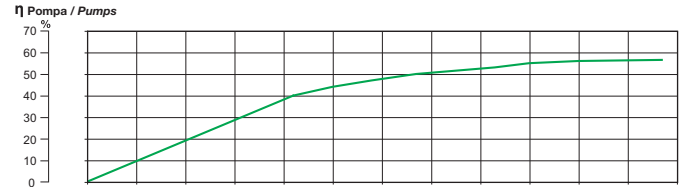
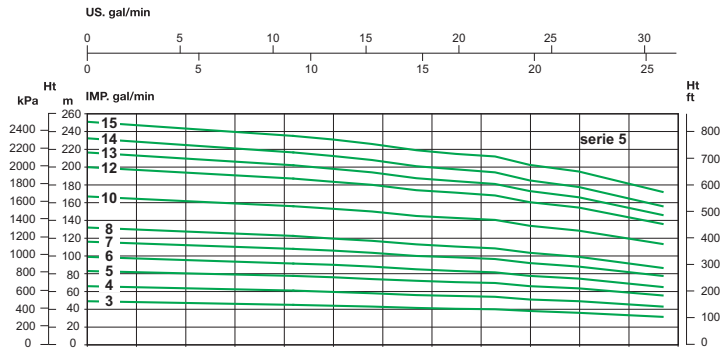

"Verti® J"



Electric pumps



Soluzione intelligente per installazioni complesse
Clever solution for complicated installations
Solution intelligente pour installations complexes
Solución inteligente para instalaciones complejas

NOMENCLATURA PARTI DI RICAMBIO
SPARE PARTS LIST
NOMENCLATURE PIECES DE RECHANGE
NOMENCLATURA REPUESTOS

Alte prestazioni
Praticità d'uso
Estremamente silenziose

High performance
Easy installation
Extremely silent

Performances élevées
Facilité d'emploi
Extrêmement silencieuses

Altas prestaciones
Practicidad de uso
Extremadamente silenciosas

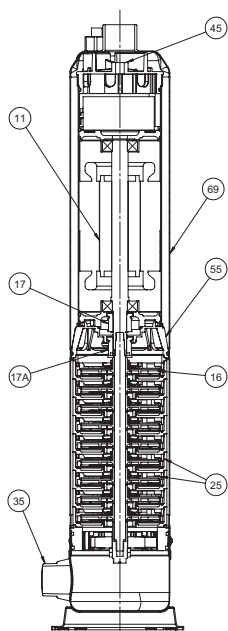

- 11 Albero con rotore – Pump shaft + rotor
Arbre + rotor – Eje rotor
- 16 Girante – Impeller
Turbine – Impulsor
- 17 Tenuta a labbro in NBR – Lip ring in NBR
Garniture à lèvres en élastomère – Anillo de cierre en NBR
- 17A Tenuta meccanica inferiore – Mechanical seal
Garniture mécanique inférieure – Cierre mecánico inferior
- 25 Diffusore – Diffuser
Diffuseur – Difusor
- 35 Base pompa – Pump base
Base pompe – Base bomba
- 45 Coperchio corpo – Cover
Couvercle corps – Tapa cuerpo
- 55 Supporto tenuta – Seal support
Support garniture – Soporte cierre
- 69 Camicia – Cover
Chemise – Camisa

TOP RANGE

ELETTROPOMPE MONOBLOCCO VERTICALI MULTISTADIO

Le elettropompe centrifughe monoblocco verticali multistadio della serie Vertì J sono state progettate utilizzando i più moderni e sofisticati sistemi di progettazione d'ingegneria e design industriale. Esse sono state studiate per pompare liquidi puliti, senza parti abrasive, senza corpi solidi in sospensione, non esplosivi o aggressivi per i materiali della pompa.

La silenziosità assoluta d'esercizio, l'utilizzo di materiali resistenti alla corrosione, la costruzione del motore che non prevede ventilazione, ne permettono una facile installazione esterna che interna (anche in ambienti sterili), oppure direttamente immerse in vasche e/o serbatoi.

- Temperatura max. del liquido fino a 35 °C per uso domestico (CEI EN 60335-2-41) o 60 °C per altri usi e temperatura ambiente fino a 40 °C.
- Portate fino a 7 m³/h.
- Prevalenze fino a ~ 40 m

CARATTERISTICHE COSTRUTTIVE

- Corpo pompa: acciaio inox Aisi 304
- Corpo motore: acciaio inox Aisi 304
- Albero pompa: acciaio inox Aisi 420 F
- Diffusori: Tecnopolimero
- Giranti: Tecnopolimero
- Tenuta meccanica lato pompa: carbone - ceramica
- Tenuta lato motore: a labbro in NBR
- Connettore estraibile a tenuta stagna con innesto rapido
- 3 m cavo di alimentazione tipo H07RN-F

MOTORE

- Motore ad induzione a due poli, riavvolgibile, refrigerato dal liquido pompato, con protezione IP68, isolamento classe F.
- Alimentazione monofase con motoprotettore incorporato e condensatore permanentemente inserito.
- Servizio continuo.

ÉLECTROPOMPES MONOBLOC VERTICALES MULTISTADIO

Les électropompes centrifuges monobloc verticales multistadio de la série Vertì J ont été conçues en utilisant les plus modernes et les plus sophistiqués systèmes de projet d'ingénierie et de design industriel. Elles ont été étudiées pour pomper des liquides propres, sans parties abrasives, sans corps liquides en suspension, non explosifs ou agressifs pour les matériaux de la pompe.

Le silence de fonctionnement absolu, l'utilisation de matériaux résistants à la corrosion, la construction du moteur qui ne prévoit pas de ventilation, en permettent une installation facile extérieure comme intérieure (même en milieux stériles), ou directement immergées dans des cuves et/ou réservoirs.

- Température max. du liquide jusqu'à 35 °C pour utilisation domestique (CEI EN 60335-2-41) ou 60 °C pour d'autres utilisations et température ambiante jusqu'à 40 °C.
- Plage d'utilisation jusqu'à 7 m³/h.
- Hauteur manométrique jusqu'à ~ 40 m

CARACTERISTIQUES DE CONSTRUCTION

- Corps de pompe : acier inox Aisi 304
- Corps de moteur: acier inox Aisi 304
- Abre de pompe: acier inox Aisi 420 F
- Diffuseurs: Technopolymère
- Turbine: Technopolymère
- Garniture mécanique partie pompe: Carbone dur - Céramique
- Garniture partie moteur: à lèvres en élastomère
- Connecteur étanche extractible avec attache rapide
- 3 m Câble d'alimentation H07RN-F.

MOTOR

- Moteur à induction à deux pôles rebobinable, refroidi par le liquide pompé, protection IP68, classe d'isolation F.
- Le modèles monophasés son avec protection thermique et condensateur connecté en permanence
- Pour les modèles triphasés, la protection est à la charge de l'utilisateur. A recommandé l'équipement conformément à la réglementation
- Service S1

VERTICAL MONOBLOC MULTISTAGE ELECTRIC PUMPS

The vertical monobloc multistage electric pumps of the series Vertì J are designed with the most advanced and sophisticated engineering and industrial design systems. They have been studied to pump clean liquids, without abrasives and suspended solids, non-explosive or aggressive for the pump's materials.

The extreme noiselessness, the use of corrosion-proof materials, on both sides and the motor construction without ventilation needed, permit an easy external or internal installation (also in sterile ambient) or they can be directly installed inside the storage tank or basin.

- Liquid temperature not higher than 35 °C for domestic use (CEI EN 60335-2-41) or 60 °C for other use, while the ambient temperature must not be higher than 40 °C
- Flow rate up to ~ 7 m³/h
- Heads up to ~ 40 m

TECHNICAL FEATURES

- Pump body: stainless steel Aisi 304
- Motor body: stainless steel Aisi 304
- Pump shaft: stainless steel Aisi 420 F
- Diffusers: Techno-polymer
- Impellers: Techno-polymer
- Pump's side mechanical seal: carbon-ceramics
- Motor's side seal: lip ring in NBR
- Quick cable coupling watertight connector
- 3 m H07RN-F feeding cable.

MOTOR

- Two poles induction rewindable motor with protection IP 68, class F insulation.
- Single-phase feeding with incorporated motor protector and capacitor permanently connected.
- Continuous duty.

ELECTROBOMBAS MONOBLOQUE VERTICALES MULTITETAPA

Las electrobombas centrifugas monobloque verticales multietapa de la serie Vertì J han sido realizadas utilizando los más modernos y sofisticados sistemas de proyectación de ingeniería y de diseño industrial. Han sido estudiadas para bombear líquidos limpios, sin partes abrasivas, sin cuerpos sólidos en suspensión y que no sean explosivos o agresivos para los materiales de la bomba.

Su funcionamiento absolutamente silencioso, el empleo de materiales resistentes a la corrosión, la construcción del motor que no prevé ventilación, permiten una fácil instalación tanto exterior como interior (incluso en ambientes estériles), o bien directamente sumergidas en tanques y/o depósitos.

- Temperatura max. del líquido hasta 35 °C para uso doméstico (CEI EN 60335-2-41) o 60 °C para otros usos y temperatura ambiente hasta 40 °C.
- Caudal hasta 7 m³/h.
- Alturas hasta ~ 40 m

CARACTERISTICAS DE CONSTRUCCIÓN

- Cuerpo de bomba: de acero Inox AISI304
- Cuerpo de motor: de acero Inox AISI304
- Eje de la bomba: de acero Inox Aisi 420 F
- Difusores: De tecnopolímero
- Rodetes: De tecnopolímero
- Cierre mecánico lado bombas: De cerámica y grafito
- Cierre lado motor: anillo de cierre en NBR
- Conector extraíble impermeable con cierre rápido
- Cable de alimentación :3 m H07RN-F

MOTOR

- Motor a induction de dos poles rebobinables, enfriado por el líquido bombeado, protección IP68, aislamiento de clase F.
- Para los modelos monofásicos, protección térmica y condensador incorporado
- Para los modelos trifásicos de la protección se encarga el usuario. y el equipo recomendado de acuerdo con las normas
- Funcionamiento S1

50 Hz - min⁻¹ ~ 2900

TIPO TYPE Monofase Single-phase	Potenza nominale Nominal power		Potenza assorbita Input power [W]	Condensatore Capacitor 450 V max [µF]	Corrente assorbita Input current [A] 1~ 230 V	Portata - Capacity								
						Q [m ³ /h]	0	1.2	2.4	3	3.6	4.8	6	7.2
	Q [l/1']	0	20	40	50	60	80	100	120					
	kW HP					Prevalenza (m C.A.) Total head (m W.C.)								
VERTI' J 103 M	0,74	1	750	16	3,5	H [m]	39,2	33,2	26,2	22,4	18,3	9,4		
VERTI' J 86 M	0,59	0,8	800	14	3,6	H [m]	34,1	30,5	26,5	24,4	22,2	17,6	12,7	7,4

a) ~ Monofase 230 V

60 Hz - min⁻¹ ~ 3400

TIPO TYPE Monofase Single-phase	Potenza nominale Nominal power		Potenza assorbita Input power [W]	Condensatore Capacitor 450 V max [µF]	Corrente assorbita Input current [A] 1~ 115 V	Portata - Capacity								
						Q [m ³ /h]	0	1.2	2.4	3	3.6	4.8	6	7.2
	Q [l/1']	0	20	40	50	60	80	100	120					
	kW HP					Prevalenza (m C.A.) Total head (m W.C.)								
VERTI' J 103 M	0,74	1	930	31,5	8,3	H [m]	38,4	32,1	26,1	23,2	20,4	14,0	9,7	4,7

a) ~ Monofase 115 V

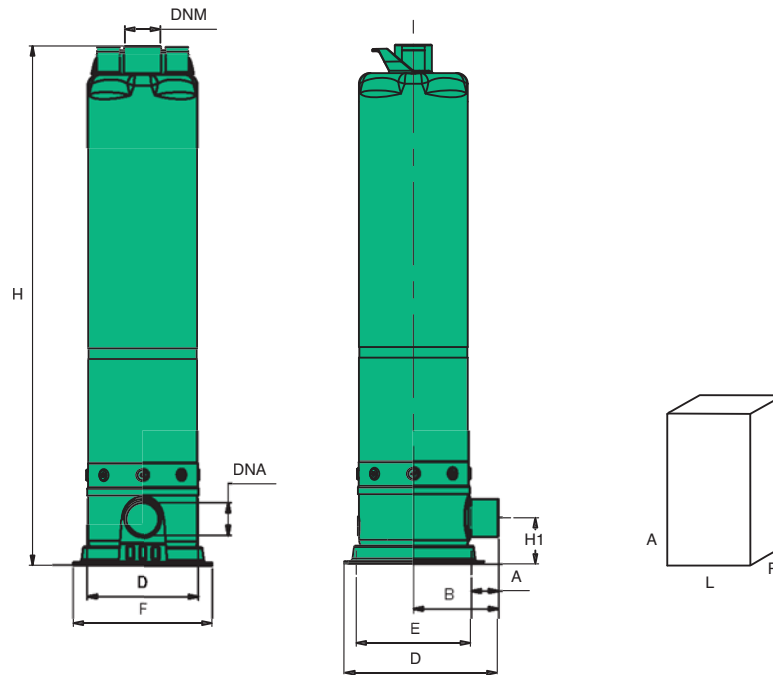

TIPO TYPE	DIMENSIONI [mm] DIMENSIONS [mm]							IMBALLO [mm] PACKING [mm]			PESO WEIGHT [kg]
	H	H1	B	E	F	DNA	DNM	A	L	P	
Verti J 103	640	65	103	130	170	1" 1/4	1"	800	190	240	11,4
Verti J 86	591	65	103	130	170	1" 1/4	1"	800	190	240	11,2

min⁻¹ ~ 2900

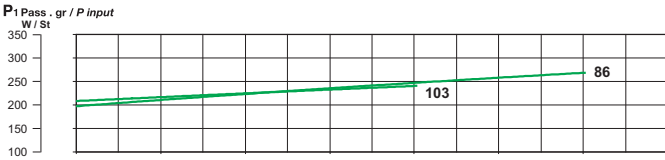
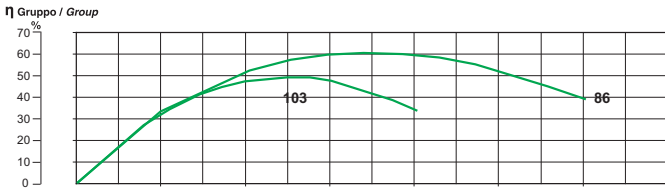
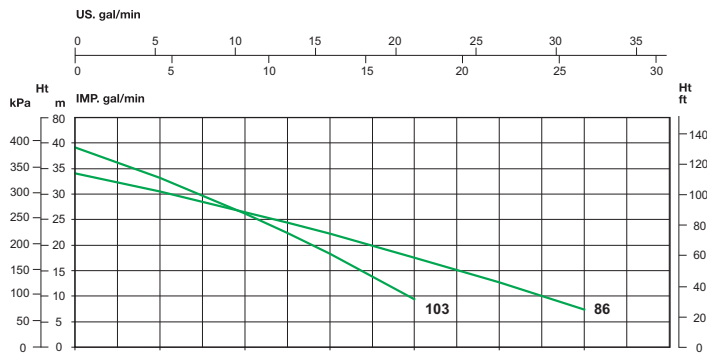

min⁻¹ ~ 3400

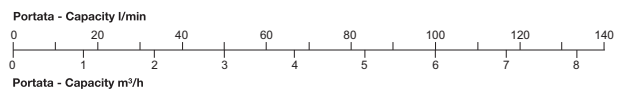
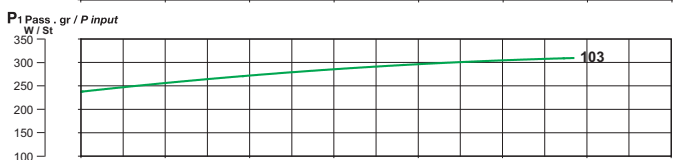
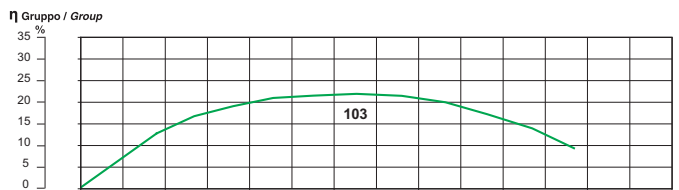
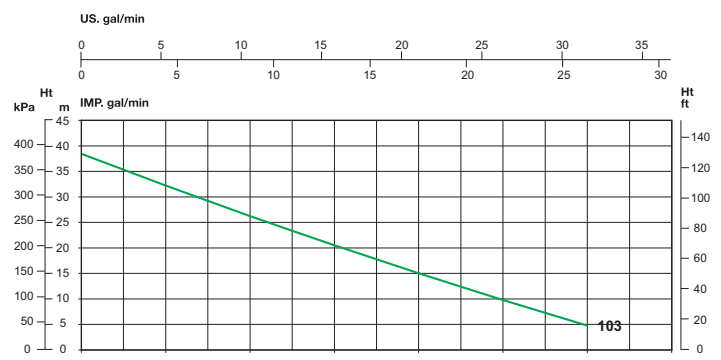

"Verti®"



Electric pumps



Soluzione intelligente per installazioni complesse
Clever solution for complicated installations
Solution intelligente pour installations complexes
Solución inteligente para instalaciones complejas

NOMENCLATURA PARTI DI RICAMBIO
SPARE PARTS LIST
NOMENCLATURE PIECES DE RECHANGE
NOMENCLATURA REPUESTOS

Alte prestazioni
Praticità d'uso
Estremamente silenziose
Connettore estraibile a tenuta stagna con innesto rapido

High performance
Easy installation
Extremely silent
Quick cable coupling watertight connector

Performances élevées
Facilité d'emploi
Extrêmement silencieuses
Connecteur extractible étanche avec accrochage rapide

Altas prestaciones
Practicidad de uso
Extremadamente silenciosas
Conector extraíble estanco de acoplamiento rápido

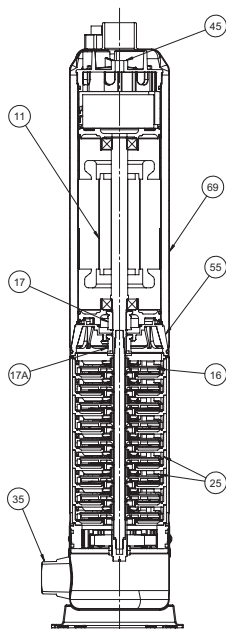

- 11 Albero con rotore – Pump shaft + rotor
Arbre + rotor – Eje rotor
- 16 Girante – Impeller
Turbine – Impulsor
- 17 Tenuta meccanica – Mechanical seal
Garniture mécanique – Cierre mecánico
- 17A Tenuta meccanica inferiore – Mechanical seal
Garniture mécanique inférieure – Cierre mecánico inferior
- 25 Diffusore – Diffuser
Diffuseur – Difusor
- 35 Base pompa – Pump base
Base pompe – Base bomba
- 45 Coperchio corpo – Cover
Couvercle corps – Tapa cuerpo
- 55 Supporto tenuta – Seal support
Support garniture – Soporte cierre
- 69 Camicia – Cover
Chemise – Camisa

TOP RANGE

ELETTROPOMPE MONOBLOCCO VERTICALI MULTISTADIO

Le elettropompe centrifughe monoblocco verticali multistadio della serie Verti sono state progettate utilizzando i più moderni e sofisticati sistemi di progettazione d'ingegneria e design industriale. Esse sono state studiate per pompare liquidi puliti, senza parti abrasive, senza corpi solidi in sospensione, non esplosivi o aggressivi per i materiali della pompa. La silenziosità assoluta d'esercizio, l'utilizzo di materiali resistenti alla corrosione, l'impiego di una doppia tenuta meccanica lubrificata da entrambi i lati, la costruzione del motore che non prevede ventilazione, ne permettono una facile installazione esterna che interna (anche in ambienti sterili), oppure direttamente immerse in vasche e/o serbatoi.

- Temperatura max. del liquido fino a 35 °C per uso domestico (CEI EN 60335-2-41) o 60 °C per altri usi e temperatura ambiente fino a 40 °C.
- Portate fino a 12 m³/h.
- Prevalenze fino a ~ 100 m

CARATTERISTICHE COSTRUTTIVE

- Corpo pompa: acciaio inox Aisi 304
- Diffusori: Tecnopolimero
- Giranti: Tecnopolimero
- Corpo motore: acciaio inox Aisi 304
- Albero pompa: acciaio inox Aisi 304
- Tenuta meccanica lato pompa: carburo di silicio-allumina
- Tenuta meccanica lato motore: grafite - allumina
- Connettore estraibile a tenuta stagna con innesto rapido
- 3 m cavo di alimentazione tipo H07RN-F

MOTORE

- Motore ad induzione a due poli, riavvolgibile, refrigerato dal liquido pompato, con protezione IP68, isolamento classe F.
- Alimentazione monofase con motoprotettore incorporato e condensatore permanentemente inserito.
- Alimentazione trifase con protezione obbligatoria a cura dell'utente.
- Servizio continuo.

ÉLECTROPOMPES MONOBLOC VERTICALES MULTISTADIO

Les électropompes centrifuges monobloc verticales multistadio de la série Verti ont été conçues en utilisant les plus modernes et les plus sophistiqués systèmes de projet d'ingénierie et de design industriel. Elles ont été étudiées pour pomper des liquides propres, sans parties abrasives, sans corps liquides en suspension, non explosifs ou agressifs pour les matériaux de la pompe.

Le silence de fonctionnement absolu, l'utilisation de matériaux résistants à la corrosion, l'emploi d'une double garniture mécanique lubrifiée des deux côtés, la construction du moteur qui ne prévoit pas de ventilation, en permettent une installation facile extérieure comme intérieure (même en milieux stériles), ou directement immergées dans des cuves et/ou réservoirs.

- Température max. du liquide jusqu'à 35 °C pour utilisation domestique (CEI EN 60335-2-41) ou 60 °C pour d'autres utilisations et température ambiante jusqu'à 40 °C.
- Plage d'utilisation jusqu'à 12 m³/h.
- Hauteur manométrique jusqu'à ~ 100 m

CARACTERISTIQUES DE CONSTRUCTION

- Corps de pompe : acier inox Aisi 304
- Diffuseurs: Technopolymère
- Turbine: Technopolymère
- Corps de moteur: acier inox Aisi 304
- Abre de pompe: acier inox Aisi 304
- Garniture mécanique partie pompe: partie pompe: carbure de silicium-alumina
- Garniture mécanique partie moteur: en graphite - alumina
- Connecteur étanche extractible avec attache rapide
- 3 m Câble d'alimentation H07RN-F.

MOTOR

- Moteur à induction à deux pôles rebobinable, refroidi par le liquide pompé, protection IP68, classe d'isolation F.
- Le modèles monophasés son avec protection thermique et condensateur connecté en permanence
- Pour les modèles triphasés, la protection est à la charge de l'utilisateur. A recommandé l'équipement conformément à la réglementation
- Service S1

VERTICAL MONOBLOC MULTISTAGE ELECTRIC PUMPS

The vertical monobloc multistage electric pumps of the series Verti are designed with the most advanced and sophisticated engineering and industrial design systems. They have been studied to pump clean liquids, without abrasives and suspended solids, non-explosive or aggressive for the pump's materials.

The extreme noiselessness, the use of corrosion-proof materials, the use of a double mechanical seal lubricated on both sides and the motor construction without ventilation needed, permit an easy external or internal installation (also in sterile ambient) or they can be directly installed inside the storage tank or basin.

- Liquid temperature not higher than 35 °C for domestic use (CEI EN 60335-2-41) or 60 °C for other use, while the ambient temperature must not be higher than 40 °C
- Flow rate up to ~ 12 m³/h
- Heads up to ~ 100 m

TECHNICAL FEATURES

- Pump body: stainless steel Aisi 304
- Diffusers: Techno-polymer
- Impellers: Techno-polymer
- Motor body: stainless steel Aisi 304
- Pump shaft: stainless steel Aisi 304
- Pump's side mechanical seal: silicon carbide- alumina
- Motor's side mechanical seal: graphite-alumina
- Quick cable coupling watertight connector
- 3 m H07RN-F feeding cable

MOTOR

- Two poles induction rewindable motor with protection IP 68, class F insulation.
- Single-phase feeding with incorporated motor protector and capacitor permanently connected.
- Three-phase feeding with compulsory protection to be provided by the user.
- Continuous duty.

ELECTROBOMBAS MONOBLOQUE VERTICALES MULTITAPAS

Las electrobombas centrifugas monobloque verticales multietapa de la serie Verti han sido realizadas utilizando los más modernos y sofisticados sistemas de proyectación de ingeniería y de diseño industrial. Han sido estudiadas para bombear líquidos limpios, sin partes abrasivas, sin cuerpos sólidos en suspensión y que no sean explosivos o agresivos para los materiales de la bomba.

Su funcionamiento absolutamente silencioso, el empleo de materiales resistentes a la corrosión, el empleo de un doble sello mecánico lubricado por ambos lados, la construcción del motor que no prevé ventilación, permiten una fácil instalación tanto exterior como interior (incluso en ambientes estériles), o bien directamente sumergidas en tanques y/o depósitos.

- Temperatura max. del líquido hasta 35 °C para uso doméstico (CEI EN 60335-2-41) o 60 °C para otros usos y temperatura ambiente hasta 40 °C.
- Caudal hasta 12 m³/h.
- Alturas hasta ~ 100 m

CARACTERISTICAS DE CONSTRUCCIÓN

- Cuerpo de bomba: de acero Inox AISI304
- Difusores: De tecnopolímero
- Rodetes: De tecnopolímero
- Cuerpo de motor: de acero Inox AISI304
- Eje de la bomba: de acero Inox AISI304
- Cierre mecánico lado bombas: carburo de silicio y alumina
- Cierre mecánico lado motor: en grafito y alumina
- Conector extraíble impermeable con cierre rápido
- Cable de alimentación :3 m H07RN-F

MOTOR

- Motor a induction de dos poles rebobinables, enfriado por el líquido bombeado, protección IP68, aislamiento de clase F.
- Para los modelos monofásicos, protección térmica y condensador incorporado
- Para los modelos trifásicos de la protección se encarga el usuario y el equipo recomendado de acuerdo con las normas
- funcionamiento S1

50 Hz - min⁻¹ ~ 2900

TIPO TYPE		Potenza nominale Nominal power		Potenza assorbita Input power [W]		Condensatore Capacitor 450 V max	Corrente assorbita Input current [A]		Portata - Capacity															
Monofase Single-phase	Trifase Three-phase	kW	HP	a	b	[μF]	1~230V	3~400V	Q [m ³ /h]	0	1.2	2.4	3	3.6	4.8	6	7.2	8.4	9	9.6	10.8	12		
a	b								Q [l/1']	0	20	40	50	60	80	100	120	140	150	160	180	200		
									Prevalenza (m C.A.) Total head (m W.C.)															
									H [m]															
Verti 123 M		0.88	1.2	1180	-	30	5.2	-		49,4	43,7	36,5	32,3	27,7	17,3	5,3								
Verti 153 M		1.1	1.5	1530	-	31.5	6.8	-		66,8	57,6	47,3	41,8	36,0	23,7	10,4								
Verti 173 M	Verti 173 T	1.47	2	1990	1890	36	9.2	4.1		88,0	76,9	63,9	56,6	48,8	31,7	12,6								
Verti 156 M		1.1	1.5	1640	-	31.5	7.3	-		52,9	49,4	45,2	42,8	40,1	34,3	27,7	20,3	12,1	7,7					
Verti 176 M	Verti 176 T	1.47	2	2170	2090	40	9.8	3.9		73,7	68,3	62,0	58,5	54,8	46,8	37,9	28,2	17,7	12,1					
Verti 206 M	Verti 206 T	1.85	2.5	2610	2610	50	11.5	4.8		94,6	87,4	79,1	74,5	69,7	59,3	47,8	35,2	21,6	14,4					
Verti 159 M		1.1	1.5	1580	-	31.5	7.1	-		40,9	39,0	36,8	35,7	34,4	31,8	29,0	25,9	22,5	20,8	19,0	14,8	10,5		
Verti 179 M	Verti 179 T	1.47	2	1950	1950	40	8.9	3.9		51,8	50,0	47,8	46,5	45,1	42,0	38,5	34,5	30,1	27,7	25,2	20,0	13,4		
Verti 209 M	Verti 209 T	1.85	2.5	2230	2240	50	9.9	4.3		62,0	60,3	57,7	56,1	54,3	50,1	45,1	39,3	32,8	30,0	27,0	21,0	15,3		
Verti 2012 M	Verti 2012 T	1,47	2	2350	2200	40	10,5	4,0		43,5	42,2	40,7	39,9	39,1	37,3	35,3	33,2	30,9	29,7	28,4	25,7	22,9		
Verti 2512 M	Verti 2512 T	1,85	2,5	2650	2800	50	11,7	5,2		53,2	51,7	50,0	49,0	48,0	45,8	43,5	40,8	38,0	36,5	34,9	31,7	28,2		
Verti 3012 M	Verti 3012 T	2,2	3	3100	3280	55	13,6	6		63,3	61,6	59,6	58,6	57,4	54,8	52,0	48,8	45,3	43,5	41,5	37,5	33,1		

a) ~ Monofase 230 V

b) ~ Trifase 400 V

60 Hz - min⁻¹ ~ 3400

TIPO TYPE		Potenza nominale Nominal power		Potenza assorbita Input power [W]		Condensatore Capacitor 450 V max	Corrente assorbita Input current [A]		Portata - Capacity															
Monofase Single-phase	Trifase Three-phase	kW	HP	a	b	[μF]	1~220V	3~380V	Q [m ³ /h]	0	1.2	2.4	3	3.6	4.8	6	7.2	8.4	9	9.6	10.8	12		
a	b								Q [l/1']	0	20	40	50	60	80	100	120	140	150	160	180	200		
									Prevalenza (m C.A.) Total head (m W.C.)															
									H [m]															
Verti 123 M		0,88	1,2	1290	-	25	6	-		47,7	45,3	40,7	37,6	34,0	25,2	14,3								
Verti 153 M		1,1	1,5	1750	-	30	8	-		69,4	64,8	57,1	52,1	46,4	32,5	15,6								
Verti 173 M	Verti 173 T	1,47	2	2600	1540	40	10,4	3,5		88,7	82,0	72,4	66,5	59,9	44,5	26,3								
Verti 156 M		1,1	1,5	1800	-	30	8,3	-		54,8	52,7	49,6	47,6	45,5	40,5	34,5	27,5	19,6	15,2					
Verti 176 M	Verti 176 T	1,47	2	2600	1650	36	11,8	3,7		76,1	73,4	69,0	66,3	63,2	55,7	46,7	36,1	24	17,3					
Verti 206 M	Verti 206 T	1,85	2,5	3000	2000	40	13,9	4,5		94,0	88,8	82,3	78,5	74,4	65,1	54,5	42,5	29,1	21,9					
Verti 159 M		1,1	1,5	2000	-	30	9,4	-		44,1	42,5	40,8	39,8	38,8	36,6	34,3	31,7	28,9	27,5	26	22,8	19,4		
Verti 179 M	Verti 179 T	1,47	2	2400	1600	36	11,1	3,5		55,7	54,1	52,1	51,0	49,8	47,1	44,1	40,8	37,2	35,2	33,2	28,9	24,3		
Verti 209 M	Verti 209 T	1,85	2,5	2650	1900	45	12,3	4,3		66,5	64,7	62,4	61,2	59,8	56,7	53,2	49,3	44,9	42,6	40,2	34,6	30,3		

a) ~ Monofase 220 V

b) ~ Trifase 380 V

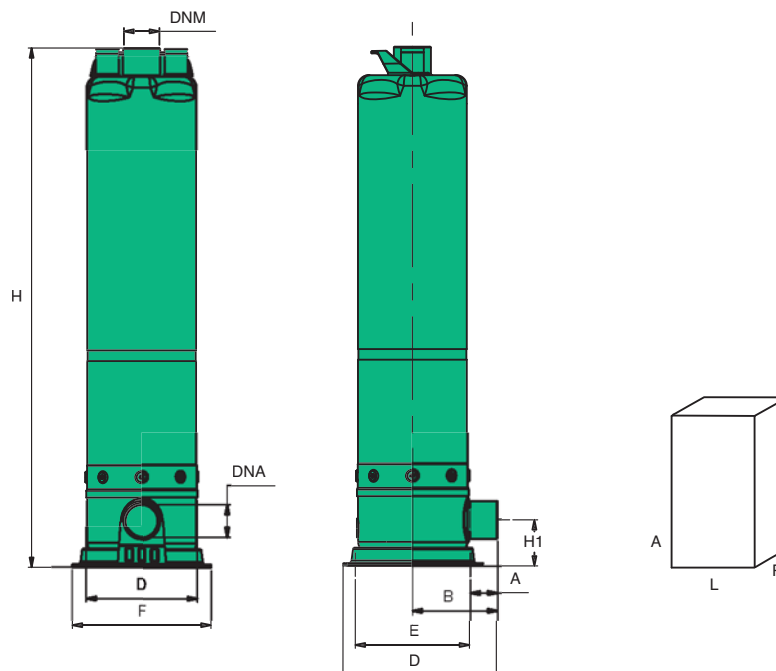



TIPO TYPE	DIMENSIONI [mm] DIMENSIONS [mm]							IMBALLO [mm] PACKING [mm]			PESO WEIGHT [kg]
	H	H1	B	E	F	DNA	DNM	A	L	P	
Verti 123 M	637	65	103	130	170	1" 1/4	1" 1/4	800	190	240	18,5
Verti 153 M	686	65	103	130	170	1" 1/4	1" 1/4	800	190	240	20,4
Verti 173 M	795	65	103	130	170	1" 1/4	1" 1/4	900	190	240	22
Verti 173 T	795	65	103	130	170	1" 1/4	1" 1/4	900	190	240	21,5
Verti 156 M	637	65	103	130	170	1" 1/4	1" 1/4	800	190	240	20
Verti 176 M	686	65	103	130	170	1" 1/4	1" 1/4	800	190	240	21
Verti 176 T	686	65	103	130	170	1" 1/4	1" 1/4	800	190	240	19,8
Verti 206 M	795	65	103	130	170	1" 1/4	1" 1/4	900	190	240	24
Verti 206 T	810	65	103	130	170	1" 1/4	1" 1/4	900	190	240	23
Verti 159 M	686	65	103	130	170	1" 1/4	1" 1/4	800	190	240	19,6
Verti 179 M	711	65	103	130	170	1" 1/4	1" 1/4	900	190	240	20
Verti 179 T	711	65	103	130	170	1" 1/4	1" 1/4	900	190	240	19,5
Verti 209 M	810	65	103	130	170	1" 1/4	1" 1/4	900	190	240	22,4
Verti 209 T	810	65	103	130	170	1" 1/4	1" 1/4	900	190	240	21,5
Verti 2012 M	686	65	103	130	170	1" 1/4	1" 1/4	800	190	240	20,6
Verti 2012 T	686	65	103	130	170	1" 1/4	1" 1/4	800	190	240	20
Verti 2512 M	711	65	103	130	170	1" 1/4	1" 1/4	900	190	240	21
Verti 2512 T	711	65	103	130	170	1" 1/4	1" 1/4	900	190	240	20,5
Verti 3012 M	810	65	103	130	170	1" 1/4	1" 1/4	900	190	240	23
Verti 3012 T	810	65	103	130	170	1" 1/4	1" 1/4	900	190	240	22

min⁻¹ ~ 2900

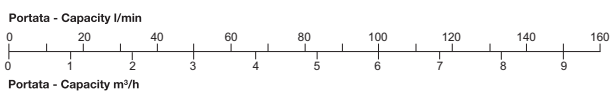
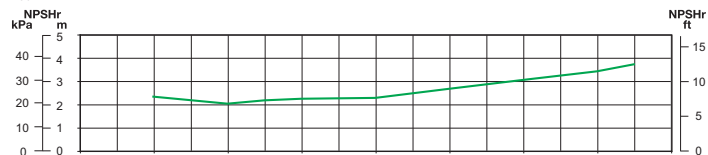
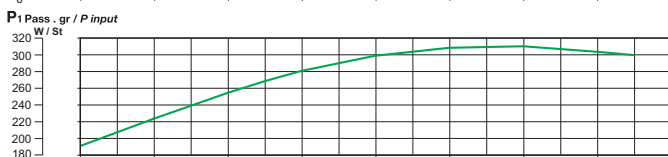
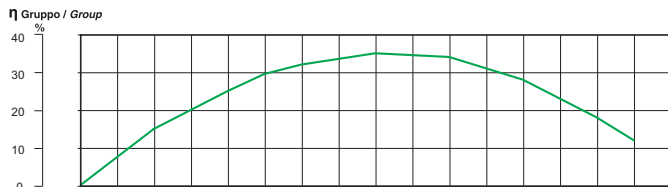
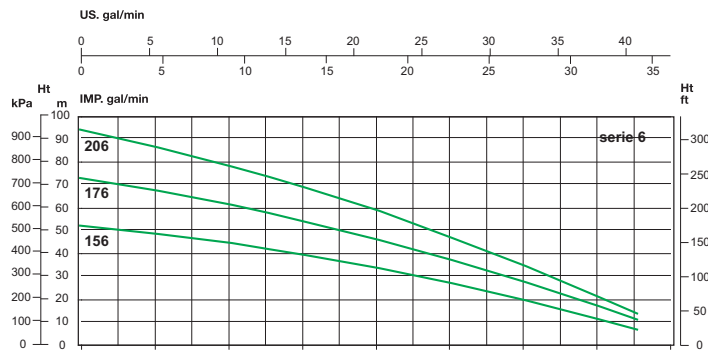
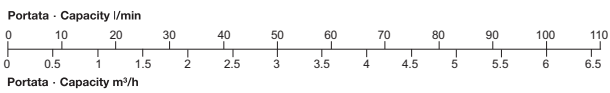
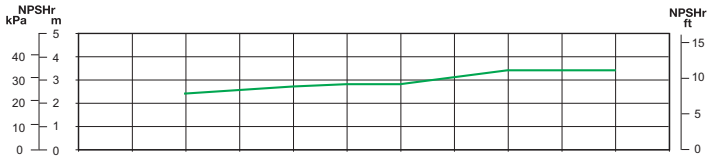
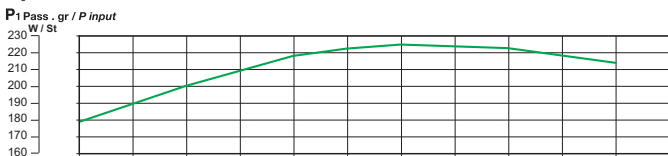
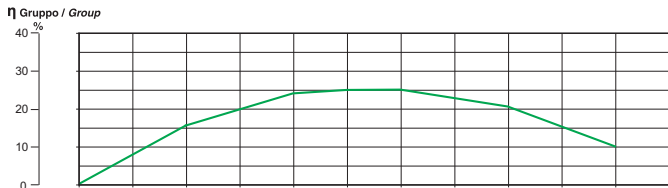
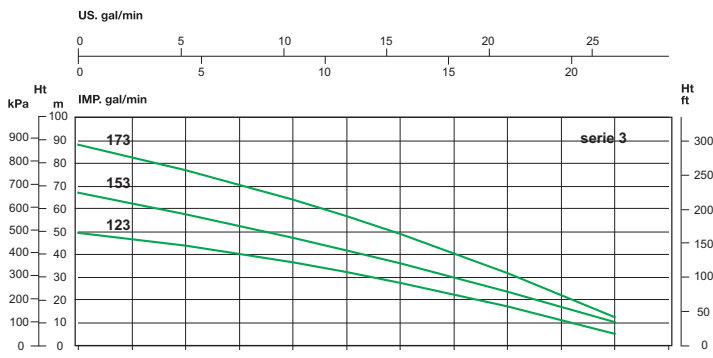

min⁻¹ ~ 3400

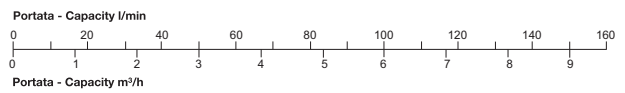
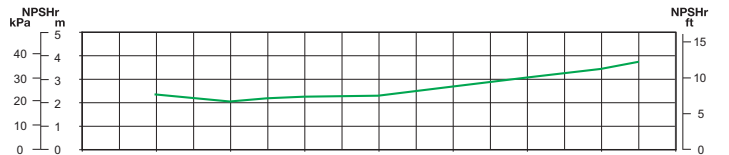
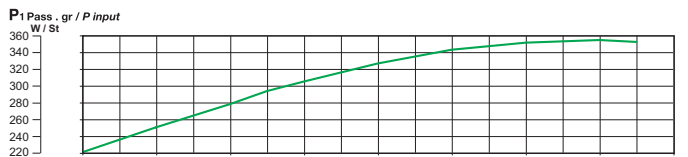
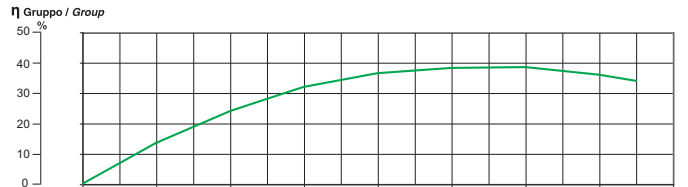
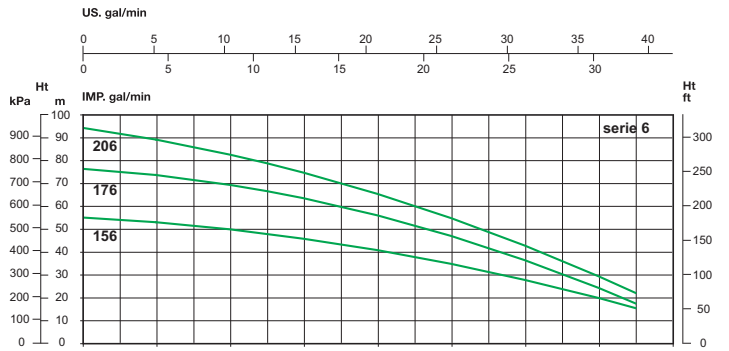
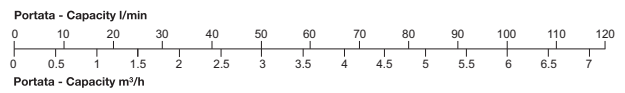
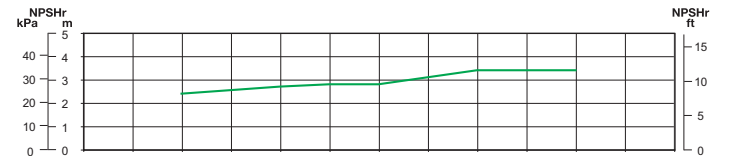
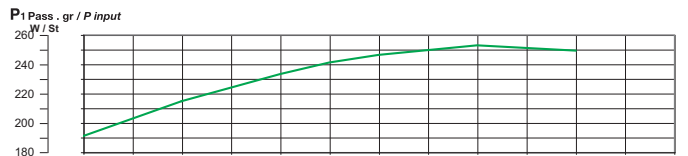
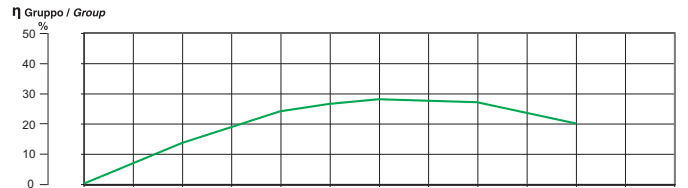
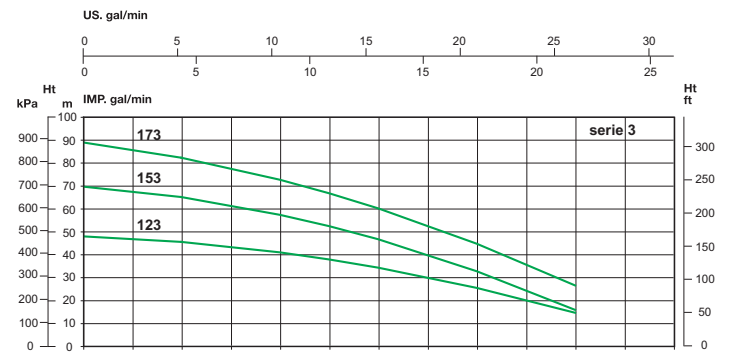

min⁻¹ ~ 2900

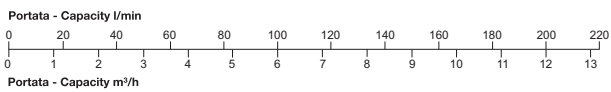
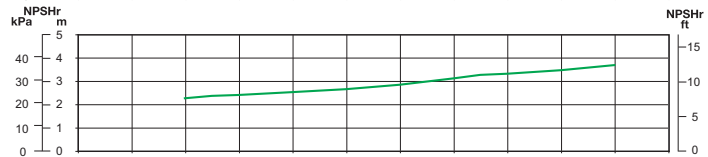
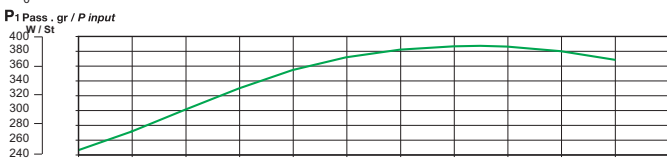
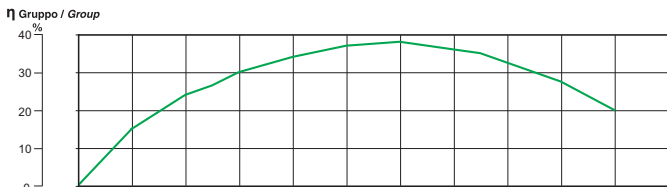
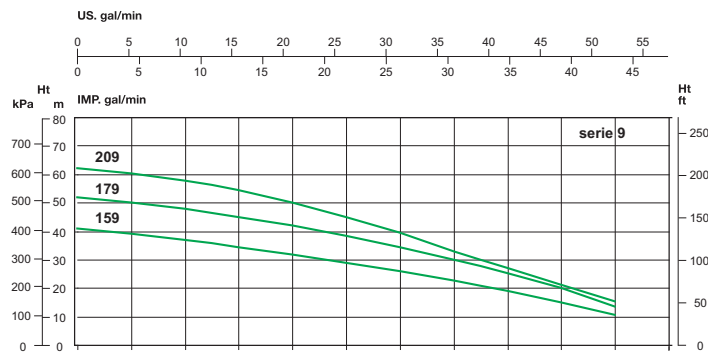

min⁻¹ ~ 3400

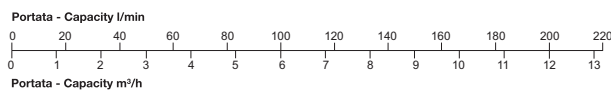
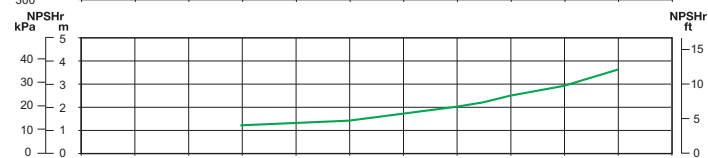
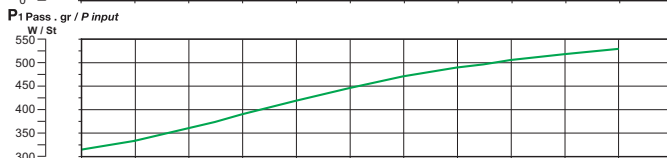
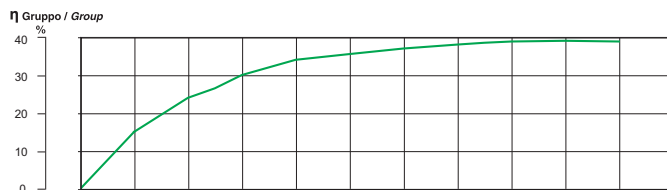
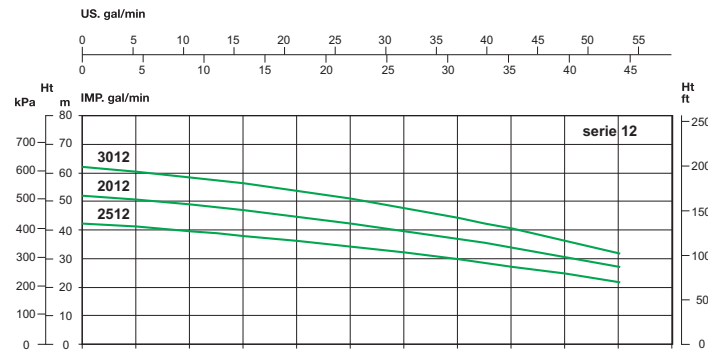
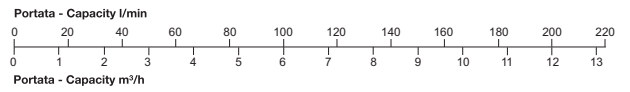
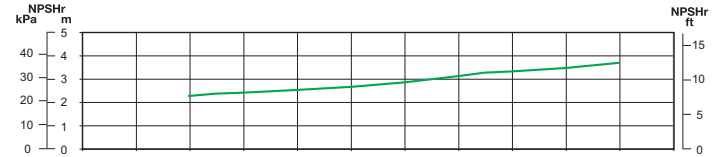
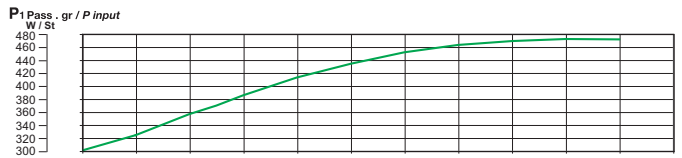
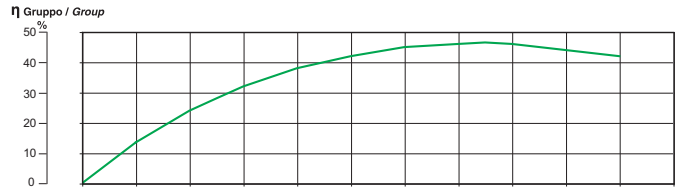
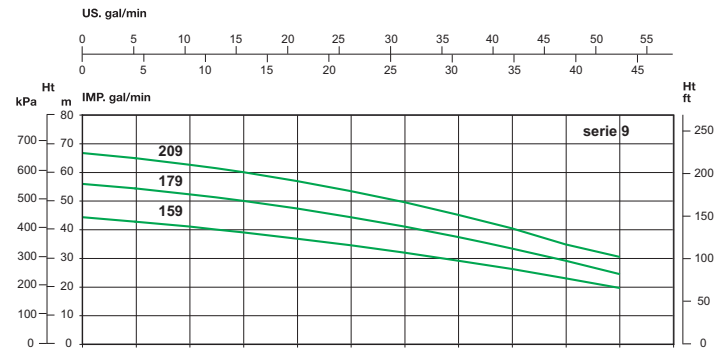

"Verti® J Line"



Electric pumps



Soluzione intelligente per installazioni complesse
Clever solution for complicated installations
Solution intelligente pour installations complexes
Solución inteligente para instalaciones complejas

NOMENCLATURA PARTI DI RICAMBIO
SPARE PARTS LIST
NOMENCLATURE PIECES DE RECHANGE
NOMENCLATURA REPUESTOS

Alte prestazioni
Praticità d'uso
Estremamente silenziose

High performance
Easy installation
Extremely silent

Performances élevées
Facilité d'emploi
Extrêmement silencieuses

Altas prestaciones
Practicidad de uso
Extremadamente silenciosas

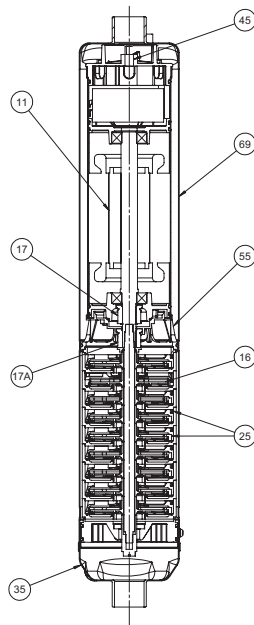

- 11** Albero con rotore – Pump shaft + rotor
Arbre + rotor – Eje rotor
- 16** Girante – Impeller
Turbine – Impulsor
- 17** Tenuta a labbro in NBR – Lip ring in NBR
Garniture à lèvres en élastomère – Anillo de cierre en NBR
- 17A** Tenuta meccanica inferiore – Mechanical seal
Garniture mécanique inférieure – Cierre mecánico inferior
- 25** Diffusore – Diffuser
Diffuseur – Difusor
- 35** Base pompa – Pump base
Base pompe – Base bomba
- 45** Coperchio corpo – Cover
Couvercle corps – Tapa cuerpo
- 55** Supporto tenuta – Seal support
Support garniture – Soporte cierre
- 69** Camicia – Cover
Chemise – Camisa

TOP RANGE

ELETTROPOMPE MONOBLOCCO MULTISTADIO IN LINEA

Le elettropompe centrifughe monoblocco verticali multistadio della serie Verti J Line sono state progettate utilizzando i più moderni e sofisticati sistemi di progettazione d'ingegneria e design industriale. Esse sono state studiate per pompare liquidi puliti, senza parti abrasive, senza corpi solidi in sospensione, non esplosivi o aggressivi per i materiali della pompa.

La silenziosità assoluta d'esercizio, l'utilizzo di materiali resistenti alla corrosione, la costruzione del motore che non prevede ventilazione, ne permettono una facile installazione esterna che interna (anche in ambienti sterili), oppure direttamente immerse in vasche e/o serbatoi.

- Temperatura max. del liquido fino a 35 °C per uso domestico (CEI EN 60335-2-41) o 60 °C per altri usi e temperatura ambiente fino a 40 °C.
- Portate fino a 7 m³/h.
- Prevalenze fino a ~ 40 m

CARATTERISTICHE COSTRUTTIVE

- Corpo pompa: acciaio inox Aisi 304
- Corpo motore: acciaio inox Aisi 304
- Albero pompa: acciaio inox Aisi 420 F
- Diffusori: Tecnopolimero
- Giranti: Tecnopolimero
- Tenuta meccanica lato pompa: carbone - ceramica
- Tenuta lato motore: a labbro in NBR
- Connettore estraibile a tenuta stagna con innesto rapido
- 3 m cavo di alimentazione tipo H07RN-F

MOTORE

- Motore ad induzione a due poli, riavvolgibile, refrigerato dal liquido pompato, con protezione IP68, isolamento classe F.
- Alimentazione monofase con motoprotettore incorporato e condensatore permanentemente inserito.
- Servizio continuo.

ÉLECTROPOMPES MONOBLOC MULTISTADIO EN LIGNE

Les électropompes centrifuges monobloc verticales multistadio de la série Verti J Line ont été conçues en utilisant les plus modernes et les plus sophistiqués systèmes de projet d'ingénierie et de design industriel. Elles ont été étudiées pour pomper des liquides propres, sans parties abrasives, sans corps liquides en suspension, non explosifs ou agressifs pour les matériaux de la pompe.

Le silence de fonctionnement absolu, l'utilisation de matériaux résistants à la corrosion, la construction du moteur qui ne prévoit pas de ventilation, en permettent une installation facile extérieure comme intérieure (même en milieux stériles), ou directement immergées dans des cuves et/ou réservoirs.

- Température max. du liquide jusqu'à 35 °C pour utilisation domestique (CEI EN 60335-2-41) ou 60 °C pour d'autres utilisations et température ambiante jusqu'à 40 °C.
- Plage d'utilisation jusqu'à 7 m³/h.
- Hauteur manométrique jusqu'à ~ 40 m

CARACTERISTIQUES DE CONSTRUCTION

- Corps de pompe : acier inox Aisi 304
- Corps de moteur: acier inox Aisi 304
- Abre de pompe: acier inox Aisi 420 F
- Diffuseurs: Technopolymère
- Turbine: Technopolymère
- Garniture mécanique partie pompe: Carbone dur - Céramique
- Garniture partie moteur: à lèvres en élastomère
- Connecteur étanche extractible avec attache rapide
- 3 m Câble d'alimentation H07RN-F.

MOTORE

- Moteur à induction à deux pôles rebobinable, refroidi par le liquide pompé, protection IP68, classe d'isolation F.
- Le modèles monophasés son avec protection thermique et condensateur connecté en permanence
- Pour les modèles triphasés, la protection est à la charge de l'utilisateur. A recommandé l'équipement conformément à la réglementation
- Service S1

IN-LINE MONOBLOC MULTISTAGE ELECTRIC PUMPS

The vertical monobloc multistage electric pumps of the series Verti J Line are designed with the most advanced and sophisticated engineering and industrial design systems. They have been studied to pump clean liquids, without abrasives and suspended solids, non-explosive or aggressive for the pump's materials.

The extreme noiselessness, the use of corrosion-proof materials, the use of a double mechanical seal lubricated on both sides and the motor construction without ventilation needed, permit an easy external or internal installation (also in sterile ambient) or they can be directly installed inside the storage tank or basin.

- Liquid temperature not higher than 35 °C for domestic use (CEI EN 60335-2-41) or 60 °C for other use, while the ambient temperature must not be higher than 40 °C
- Flow rate up to ~ 7 m³/h
- Heads up to ~ 40 m

TECHNICAL FEATURES

- Pump body: stainless steel Aisi 304
- Motor body: stainless steel Aisi 304
- Pump shaft: stainless steel Aisi 420 F
- Diffusers: Techno-polymer
- Impellers: Techno-polymer
- Pump's side mechanical seal: carbon-ceramics
- Motor's side seal: lip ring in NBR
- Quick cable coupling watertight connector
- 3 m H07RN-F feeding cable.

MOTOR

- Two poles induction rewindable motor with protection IP 68, class F insulation.
- Single-phase feeding with incorporated motor protector and capacitor permanently connected.
- Continuous duty.

ELECTROBOMBAS MONOBLOQUE MULTITAPPA EN LINEA

Las electrobombas centrifugas monobloque verticales multietapa de la serie Verti J Line han sido realizadas utilizando los más modernos y sofisticados sistemas de proyectación de ingeniería y de diseño industrial. Han sido estudiadas para bombear líquidos limpios, sin partes abrasivas, sin cuerpos sólidos en suspensión y que no sean explosivos o agresivos para los materiales de la bomba.

Su funcionamiento absolutamente silencioso, el empleo de materiales resistentes a la corrosión, la construcción del motor que no prevé ventilación, permiten una fácil instalación tanto exterior como interior (incluso en ambientes estériles), o bien directamente sumergidas en tanques y/o depósitos.

- Temperatura max. del líquido hasta 35 °C para uso doméstico (CEI EN 60335-2-41) o 60 °C para otros usos y temperatura ambiente hasta 40 °C.
- Caudal hasta 7 m³/h.
- Alturas hasta ~ 40 m

CARACTERISTICAS DE CONSTRUCCIÓN

- Cuerpo de bomba: de acero Inox AISI304
- Cuerpo de motor: de acero Inox AISI304
- Eje de la bomba: de acero Inox Aisi 420 F
- Difusores: De tecnopolimero
- Rodetes: De tecnopolimero
- Cierre mecánico lado bombas: De cerámica y grafito
- Cierre lado motor: anillo de cierre en NBR
- Conector extraíble impermeable con cierre rápido
- Cable de alimentación :3 m H07RN-F

MOTORE

- Motor a induction de dos poles rebobinables, enfriado por el líquido bombeado, protección IP68, aislamiento de clase F.
- Para los modelos monofásicos, protección térmica y condensador incorporado
- Para los modelos trifásicos de la protección se encarga el usuario y el equipo recomendado de acuerdo con las normas
- Funcionamiento S1

50 Hz - min⁻¹ ~ 2900

TIPO TYPE Monofase Single-phase	Potenza nominale Nominal power		Potenza assorbita Input power [W]	Condensatore Capacitor 450 V max [µF]	Corrente assorbita Input current [A] 1~ 230 V	Portata - Capacity											
						Q [m ³ /h]	0	1.2	2.4	3	3.6	4.8	6	7.2			
						Q [l/s]	0	20	40	50	60	80	100	120			
						Prevalenza (m C.A.) Total head (m W.C.)											
						H [m]	39,2	33,2	26,2	22,4	18,3	9,4					
						H [m]	34,1	30,5	26,5	24,4	22,2	17,6	12,7	7,4			
VERTÌ J Line 103 M	0,74	1	750	16	3,5												
VERTÌ J Line 86 M	0,59	0,8	800	14	3,6												

a) ~ Monofase 230 V

60 Hz - min⁻¹ ~ 3400

TIPO TYPE Monofase Single-phase	Potenza nominale Nominal power		Potenza assorbita Input power [W]	Condensatore Capacitor 450 V max [µF]	Corrente assorbita Input current [A] 1~ 115 V	Portata - Capacity											
						Q [m ³ /h]	0	1.2	2.4	3	3.6	4.8	6	7.2			
						Q [l/s]	0	20	40	50	60	80	100	120			
						Prevalenza (m C.A.) Total head (m W.C.)											
						H [m]	38,4	32,1	26,1	23,2	20,4	14,9	9,7	4,7			
Verti J Line 103 M	0,74	1	930	31,5	8,3												

a) ~ Monofase 115 V



TIPO TYPE	DIMENSIONI [mm] DIMENSIONS [mm]				IMBALLO [mm] PACKING [mm]			PESO WEIGHT [kg]
	H	D	DNA	DNM	A	L	P	
Verti J Line 103	640	136	1" 1/4	1" 1/4	800	190	240	11,4
Verti J Line 86	591	136	1" 1/4	1" 1/4	800	190	240	11,2

min⁻¹ ~ 2900

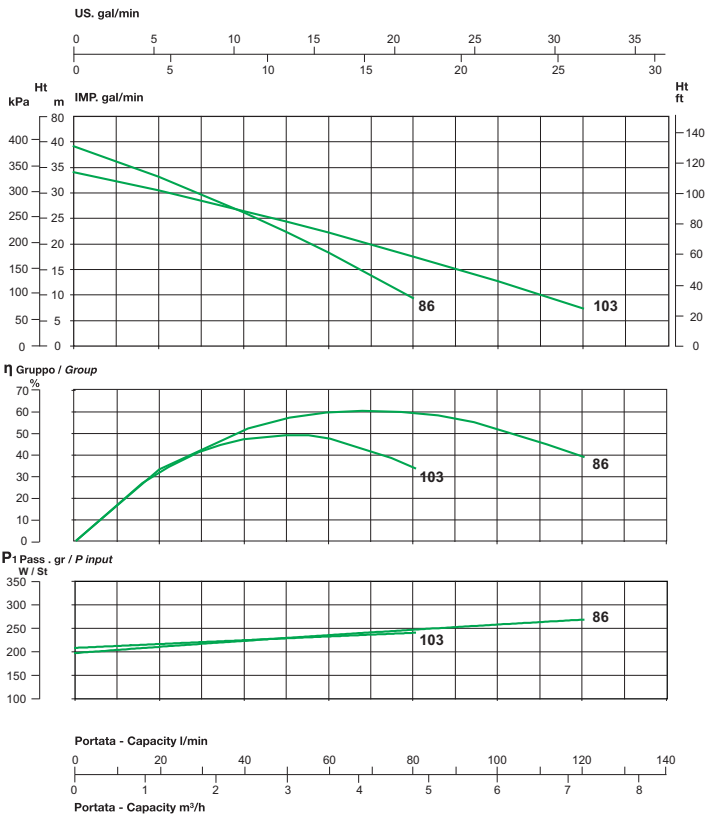

min⁻¹ ~ 3400

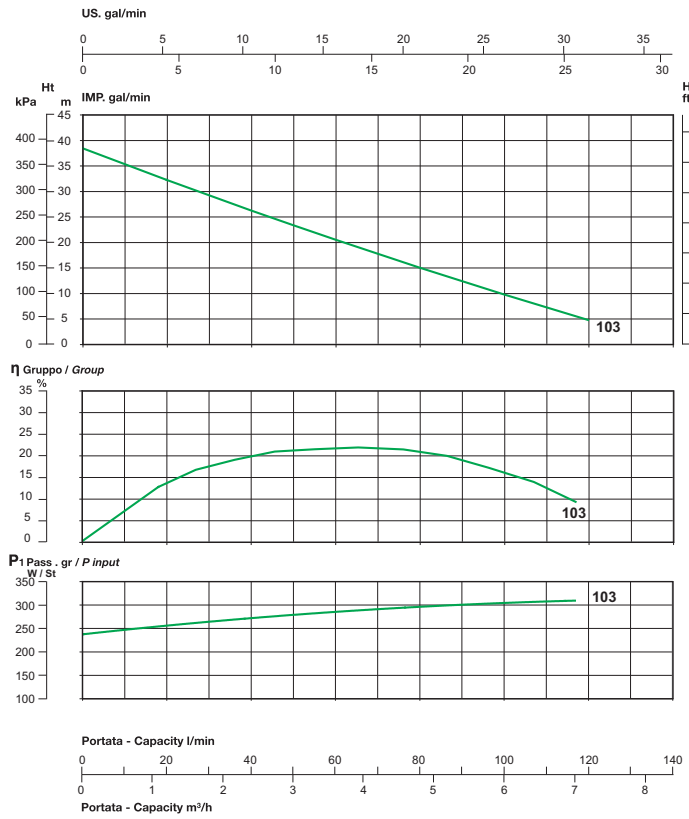

"Verti® Line"



Electric pumps



Soluzione intelligente per installazioni complesse
Clever solution for complicated installations
Solution intelligente pour installations complexes
Solución inteligente para instalaciones complejas

NOMENCLATURA PARTI DI RICAMBIO
SPARE PARTS LIST
NOMENCLATURE PIECES DE RECHANGE
NOMENCLATURA REPUESTOS

Alte prestazioni
Praticità d'uso
Estremamente silenziose
Connettore estraibile a tenuta stagna con innesto rapido

High performance
Easy installation
Extremely silent
Quick cable coupling watertight connector

Performances élevées
Facilité d'emploi
Extrêmement silencieuses
Connecteur extractible étanche avec accrochage rapide

Altas prestaciones
Practicidad de uso
Extremadamente silenciosas
Conector extraíble estanco de acoplamiento rápido

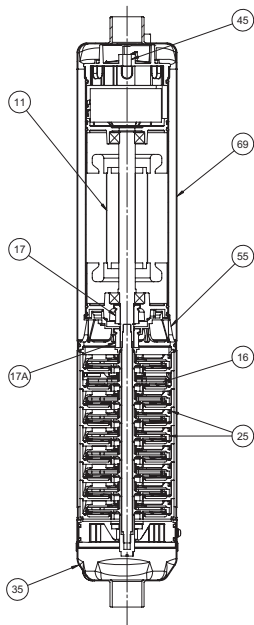

- 11 Albero con rotore – Pump shaft + rotor
Arbre + rotor – Eje rotor
- 16 Girante – Impeller
Turbine – Impulsor
- 17 Tenuta meccanica – Mechanical seal
Garniture mécanique – Cierre mecánico
- 17A Tenuta meccanica inferiore – Mechanical seal
Garniture mécanique inférieure – Cierre mecánico inferior
- 25 Diffusore – Diffuser
Diffuseur – Difusor
- 35 Base pompa – Pump base
Base pompe – Base bomba
- 45 Coperchio corpo – Cover
Couvercle corps – Tapa cuerpo
- 55 Supporto tenuta – Seal support
Support garniture – Soporte cierre
- 69 Camicia – Cover
Chemise – Camisa

TOP RANGE

ELETTROPOMPE MONOBLOCCO MULTISTADIO IN LINEA

Le elettropompe centrifughe monoblocco multistadio in linea della serie Verti Line sono state progettate utilizzando i più moderni e sofisticati sistemi di progettazione d'ingegneria e design industriale. Esse sono state studiate per pompare liquidi puliti senza parti abrasive, senza corpi solidi in sospensione, non esplosivi.

La silenziosità assoluta d'esercizio, l'utilizzo di materiali resistenti alla corrosione, l'impiego di una doppia tenuta meccanica lubrificata da entrambi i lati, la costruzione del motore che non prevede ventilazione, ne permettono una facile installazione esterna che interna (anche in ambienti sterili), oppure direttamente immerse in vasche e/o serbatoi.

- Temperatura max. del liquido fino a 35 °C per uso domestico (CEI EN 60335-2-41) o 60 °C per altri usi e temperatura ambiente fino a 40 °C.
- Portate fino a 12 m³/h.
- Prevalenze fino a ~ 100 m

CARATTERISTICHE COSTRUTTIVE

- Corpo pompa: acciaio inox Aisi 304
- Diffusori: Tecnopolimero
- Giranti: Tecnopolimero
- Corpo motore: acciaio inox Aisi 304
- Albero pompa: acciaio inox Aisi 304
- Tenuta lato pompa: meccanica in carburo di silicio-allumina
- Tenuta lato motore: meccanica in grafite allumina
- Connettore estraibile a tenuta stagna con innesto rapido
- 3 m cavo alimentazione tipo H07RN-F.

MOTORE

- Motore ad induzione a due poli, riavvolgibile, refrigerato dal liquido pompato, con protezione IP68, isolamento classe F.
- Alimentazione monofase con motoprotettore incorporato e condensatore permanentemente inserito.
- Alimentazione trifase con protezione obbligatoria a cura dell'utente.
- Servizio continuo.

ÉLECTROPOMPES MONOBLOC MULTISTADIO EN LIGNE

Les électropompes centrifuges monobloc multistadio en ligne de la série Verti Line ont été conçues en utilisant les plus modernes et les plus sophistiqués systèmes de projet d'ingénierie et de design industriel. Elles ont été étudiées pour pomper des liquides propres sans parties abrasives, sans corps liquides en suspension, non explosifs.

Le silence de fonctionnement absolu, l'utilisation de matériaux résistants à la corrosion, l'emploi d'une double garniture mécanique lubrifiée des deux côtés, la construction du moteur qui ne prévoit pas de ventilation, en permettent une installation facile extérieure comme intérieure (même en milieux stériles), ou directement immergées dans des cuves et/ou réservoirs.

- Température max. du liquide jusqu'à 35 °C pour utilisation domestique (CEI EN 60335-2-41) ou 60 °C pour d'autres utilisations et température ambiante jusqu'à 40 °C.
- Plage d'utilisation jusqu'à 12 m³/h.
- Hauteur manométrique jusqu'à ~ 100 m

CARACTERISTIQUES DE CONSTRUCTION

- Corps de pompe : acier inox Aisi 304
- Diffuseurs: Technopolymère
- Turbine: Technopolymère
- Corps de moteur: acier inox Aisi 304
- Abre de pompe: acier inox Aisi 304
- Garniture mécanique partie pompe: partie pompe: carbure de silicium-alumina
- Garniture mécanique partie moteur: en graphite - alumina
- Connecteur étanche extractible avec attache rapide
- 3 m Câble d'alimentation H07RN-F.

MOTOR

- Moteur à induction à deux pôles rebobinable, refroidi par le liquide pompé, protection IP68, classe d'isolation F.
- Le modèles monophasés son avec protection thermique et condensateur connecté en permanence
- Pour les modèles triphasés, la protection est à la charge de l'utilisateur. A recommandé l'équipement conformément à la réglementation
- Service S1

IN LINE MONOBLOC MULTISTAGE ELECTRIC PUMPS

The in line monobloc centrifugal multistage electric pumps of the series Verti Line are designed with the most advanced and sophisticated engineering and industrial design systems. They have been studied to pump clean liquids, without abrasives and suspended solids, non-explosive or aggressive for the pump's materials.

The extreme noiselessness, the use of corrosion-proof materials, the use of a double mechanical seal lubricated on both sides and the motor construction without ventilation needed, permit an easy external or internal installation (also in sterile ambient) or they can be directly installed inside the storage tank or basin.

- Liquid temperature not higher than 35 °C for domestic use (CEI EN 60335-2-41) or 60 °C for other use, while the ambient temperature must not be higher than 40 °C
- Flow rate up to ~ 12 m³/h
- Heads up to ~ 100 m

TECHNICAL FEATURES

- Pump body: stainless steel Aisi 304
- Diffusers: Techno-polymer
- Impellers: Techno-polymer
- Motor body: stainless steel Aisi 304
- Pump shaft: stainless steel Aisi 304
- Pump's side mechanical seal: silicon carbide- alumina
- Motor's side mechanical seal: graphite-alumina quick cable coupling watertight connector
- 3 m H07RN-F feeding cable.

MOTOR

- Two poles induction rewindable motor with protection IP 68, class F insulation.
- Single-phase feeding with incorporated motor protector and capacitor permanently connected.
- Three-phase feeding with compulsory protection to be provided by the user.
- Continuous duty.

ELECTROBOMBAS MONOBLOQUE MULTIETAPA IN LINEA

Las electrobombas centrifugas monobloque multietapa en línea de la serie Verti Line han sido realizadas utilizando los más modernos y sofisticados sistemas de proyectación de ingeniería y de diseño industrial. Han sido estudiadas para bombear líquidos limpios, sin partes abrasivas, sin cuerpos sólidos en suspensión y que no sean explosivos o agresivos para los materiales de la bomba.

Su funcionamiento absolutamente silencioso, el empleo de materiales resistentes a la corrosión, el empleo de un doble sello mecánico lubricado por ambos lados, la construcción del motor que no prevé ventilación, permiten una fácil instalación tanto exterior como interior (incluso en ambientes estériles), o bien directamente sumergidas en tanques y/o depósitos.

- Temperatura max. del líquido hasta 35 °C para uso doméstico (CEI EN 60335-2-41) o 60 °C para otros usos y temperatura ambiente hasta 40 °C.
- Caudal hasta 12 m³/h.
- Alturas hasta ~ 100 m

CARACTERISTICAS DE CONSTRUCCIÓN

- Cuerpo de bomba: de acero Inox AISI304
- Difusores: De tecnopolímero
- Rodetes: De tecnopolímero
- Cuerpo de motor: de acero Inox AISI304
- Eje de la bomba: de acero Inox AISI304
- Cierre mecánico lado bombas: carburo de silicio y alúmina
- Cierre mecánico lado motor: en grafito y alúmina
- Conector extraíble impermeable con cierre rápido
- Cable de alimentación: 3 m H07RN-F

MOTOR

- Motor a induction de dos poles rebobinables, enfriado por el líquido bombeado, protección IP68, aislamiento de clase F.
- Para los modelos monofásicos, protección térmica y condensador incorporado
- Para los modelos trifásicos de la protección se encarga el usuario y el equipo recomendado de acuerdo con las normas
- Funcionamiento S1

50 Hz - min⁻¹ ~ 2900

TIPO TYPE		Potenza nominale Nominal power		Potenza assorbita Input power [W]		Condensatore Capacitor 450 V max	Corrente assorbita Input current [A]		Portata - Capacity															
Monofase Single-phase	Trifase Three-phase	kW	HP	a	b	[μF]	1~230V	3~400V	Q [m³/h]	0	1.2	2.4	3	3.6	4.8	6	7.2	8.4	9	9.6	10.8	12		
									Q [l/1']	0	20	40	50	60	80	100	120	140	150	160	180	200		
										Prevalenza (m C.A.) Total head (m W.C.)														
a	b																							
Verti Line 123 M		0.88	1.2	1180	-	30	5.2	-	H [m]	49,4	43,7	36,5	32,3	27,7	17,3	5,3								
Verti Line 153 M		1.1	1.5	1530	-	31.5	6.8	-		66,8	57,6	47,3	41,8	36,0	23,7	10,4								
Verti Line 173 M	Verti Line 173 T	1.47	2	1990	1890	36	9.2	4.1		88,0	76,9	63,9	56,6	48,8	31,7	12,6								
Verti Line 156 M		1.1	1.5	1640	-	31.5	7.3	-		52,9	49,4	45,2	42,8	40,1	34,3	27,7	20,3	12,1	7,7					
Verti Line 176 M	Verti Line 176 T	1.47	2	2170	2090	40	9.8	3.9		73,7	68,3	62,0	58,5	54,8	46,8	37,9	28,2	17,7	12,1					
Verti Line 206 M	Verti Line 206 T	1.85	2.5	2610	2610	50	11.7	4.8		94,6	87,4	79,1	74,5	69,7	59,3	47,8	35,2	21,6	14,4					
Verti Line 159 M		1.1	1.5	1580	-	31.5	7.1	-		40,9	39,0	36,8	35,7	34,4	31,8	29,0	25,9	22,5	20,8	19,0	14,8	10,5		
Verti Line 179 M	Verti Line 179 T	1.47	2	1950	1950	40	8.9	3.9		51,8	50,0	47,8	46,5	45,1	42,0	38,5	34,5	30,1	27,7	25,2	20,0	13,4		
Verti Line 209 M	Verti Line 209 T	1.85	2.5	2340	2240	50	10.6	4.3		62,0	60,3	57,7	56,1	54,3	50,1	45,1	39,3	32,8	30,0	27,0	21,0	15,3		
Verti Line 2012 M	Verti Line 2012 T	1,47	2	2350	2200	40	10,5	4,0		43,5	42,2	40,7	39,9	39,1	37,3	35,3	33,2	30,9	29,7	28,4	25,7	22,9		
Verti Line 2512 M	Verti Line 2512 T	1,85	2,5	2650	2800	50	11,7	5,2		53,2	51,7	50,0	49,0	48,0	45,8	43,5	40,8	38,0	36,5	34,9	31,7	28,2		
Verti Line 3012 M	Verti Line 3012 T	2,2	3	3100	3280	55	13,6	6		63,3	61,6	59,6	58,6	57,4	54,8	52,0	48,8	45,3	43,5	41,5	37,5	33,1		

a) ~ Monofase 230 V

b) ~ Trifase 400 V

60 Hz - min⁻¹ ~ 3400

TIPO TYPE		Potenza nominale Nominal power		Potenza assorbita Input power [W]		Condensatore Capacitor 450 V max	Corrente assorbita Input current [A]		Portata - Capacity														
Monofase Single-phase	Trifase Three-phase	kW	HP	a	b	[μF]	1~220V	3~380V	Q [m³/h]	0	1.2	2.4	3	3.6	4.8	6	7.2	8.4	9	9.6	10.8	12	
									Q [l/1']	0	20	40	50	60	80	100	120	140	150	160	180	200	
										Prevalenza (m C.A.) Total head (m W.C.)													
a	b																						
Verti Line 123 M		0.88	1.2	1290	-	25	6	-	H [m]	47,7	45,3	40,7	37,6	34,0	25,2	14,3							
Verti Line 153 M		1.1	1.5	1750	-	30	8	-		69,4	64,8	57,1	52,1	46,4	32,5	15,6							
Verti Line 173 M	Verti Line 173 T	1.47	2	2600	1540	40	10,4	3,5		88,7	82,0	72,4	66,5	59,9	44,5	26,3							
Verti Line 156 M		1.1	1.5	1800	-	30	8,3	-		54,8	52,7	49,6	47,6	45,5	40,5	34,5	27,5	19,6	15,2				
Verti Line 176 M	Verti Line 176 T	1.47	2	2600	1650	36	11,8	3,7		76,1	73,4	69,0	66,3	63,2	55,7	46,7	36,1	24	17,3				
Verti Line 206 M	Verti Line 206 T	1.85	2.5	3000	2000	40	13,9	4,5		94,0	88,8	82,3	78,5	74,4	65,1	54,5	42,5	29,1	21,9				
Verti Line 159 M		1.1	1.5	2000	-	30	9,4	-		44,1	42,5	40,8	39,8	38,8	36,6	34,3	31,7	28,9	27,5	26	22,8	19,4	
Verti Line 179 M	Verti Line 179 T	1.47	2	2400	1600	36	11,1	3,5		55,7	54,1	52,1	51,0	49,8	47,1	44,1	40,8	37,2	35,2	33,2	28,9	24,3	
Verti Line 209 M	Verti Line 209 T	1.85	2.5	2650	1900	45	12,3	4,3		66,5	64,7	62,4	61,2	59,8	56,7	53,2	49,3	44,9	42,6	40,2	34,6	30,3	

a) ~ Monofase 230 V

b) ~ Trifase 400 V

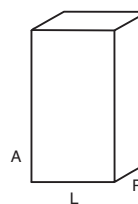
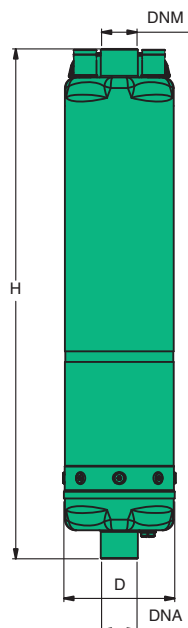



TIPO TYPE	DIMENSIONI [mm] DIMENSIONS [mm]				IMBALLO [mm] PACKING [mm]			PESO WEIGHT [kg]
	H	D	DNA	DNM	A	L	P	
Verti Line 123 M	626	136	1" 1/4	1" 1/4	800	190	240	18
Verti Line 153 M	675	136	1" 1/4	1" 1/4	800	190	240	20
Verti Line 173 M	784	136	1" 1/4	1" 1/4	900	190	240	21,5
Verti Line 173 T	784	136	1" 1/4	1" 1/4	900	190	240	21
Verti Line 156 M	626	136	1" 1/4	1" 1/4	800	190	240	19,5
Verti Line 176 M	675	136	1" 1/4	1" 1/4	800	190	240	20,5
Verti Line 176 T	675	136	1" 1/4	1" 1/4	800	190	240	19
Verti Line 206 M	784	136	1" 1/4	1" 1/4	900	190	240	23,5
Verti Line 206 T	784	136	1" 1/4	1" 1/4	900	190	240	23
Verti Line 159 M	675	136	1" 1/4	1" 1/4	800	190	240	19,1
Verti Line 179 M	699	136	1" 1/4	1" 1/4	900	190	240	19,5
Verti Line 179 T	699	136	1" 1/4	1" 1/4	900	190	240	19
Verti Line 209 M	798	136	1" 1/4	1" 1/4	900	190	240	22
Verti Line 209 T	798	136	1" 1/4	1" 1/4	900	190	240	21,5
Verti Line 2012 M	675	136	1" 1/4	1" 1/4	800	190	240	20
Verti Line 2012 T	675	136	1" 1/4	1" 1/4	800	190	240	19,5
Verti Line 2512 M	699	136	1" 1/4	1" 1/4	900	190	240	21
Verti Line 2512 T	699	136	1" 1/4	1" 1/4	900	190	240	20,5
Verti Line 3012 M	798	136	1" 1/4	1" 1/4	900	190	240	23
Verti Line 3012 T	798	136	1" 1/4	1" 1/4	900	190	240	22,5

min⁻¹ ~ 2900

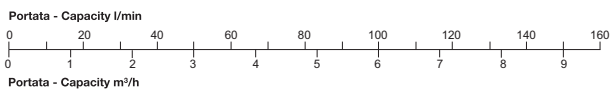
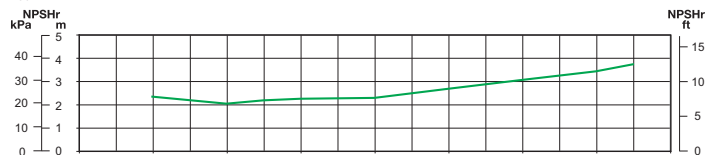
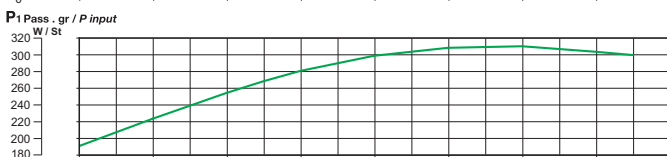
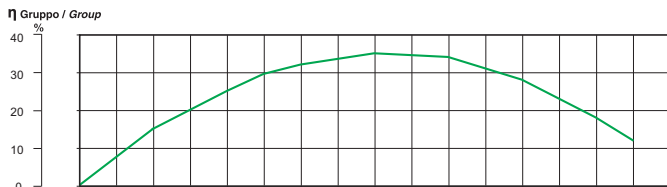
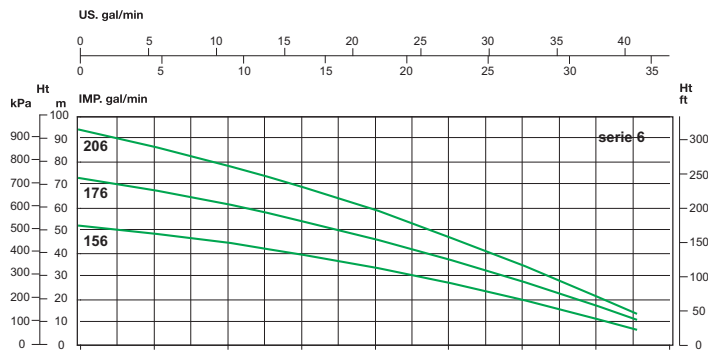
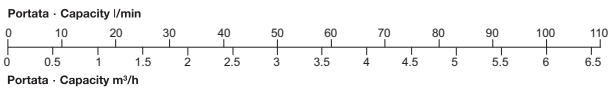
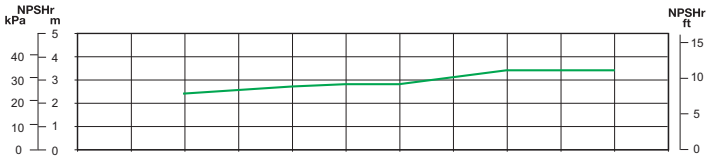
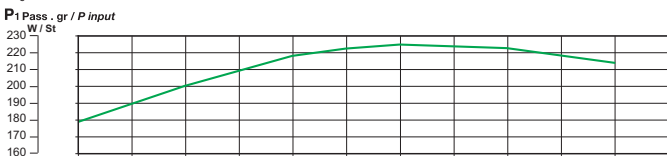
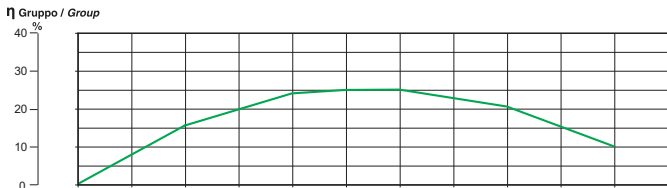
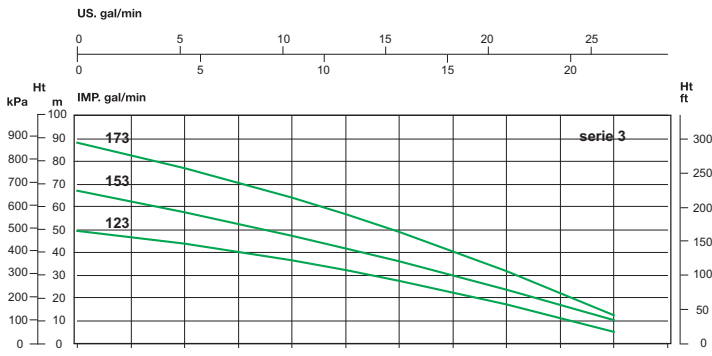

min⁻¹ ~ 3400

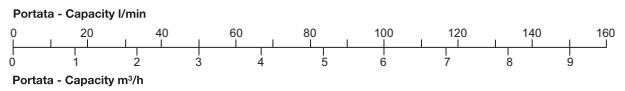
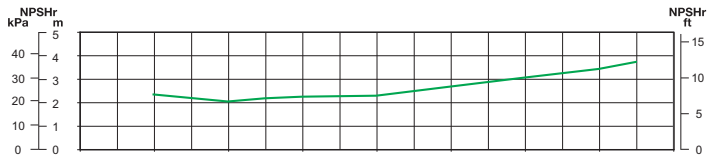
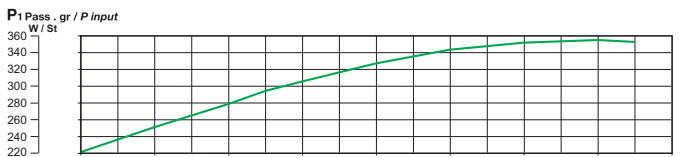
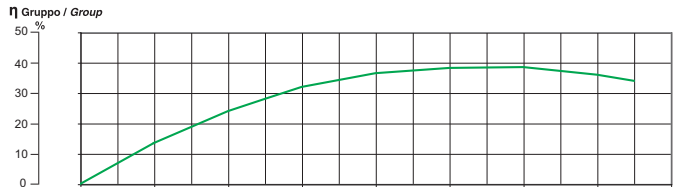
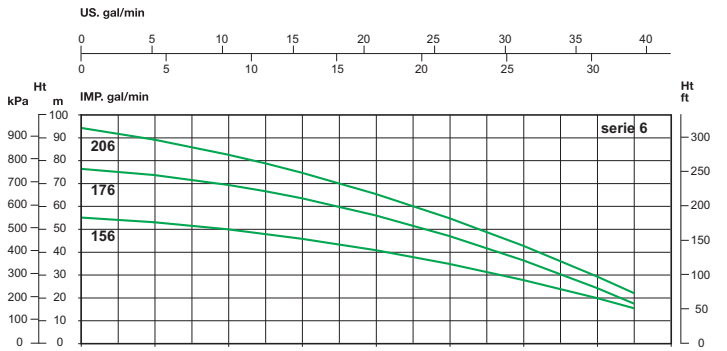
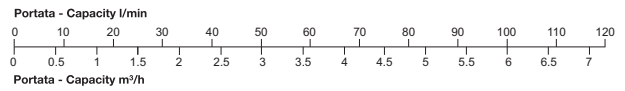
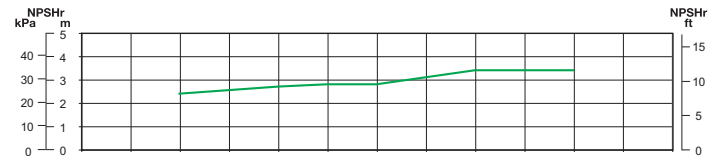
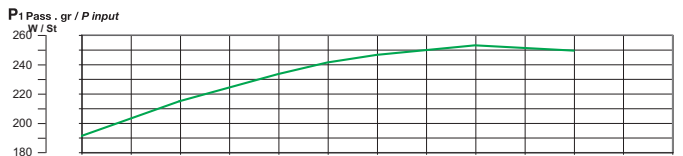
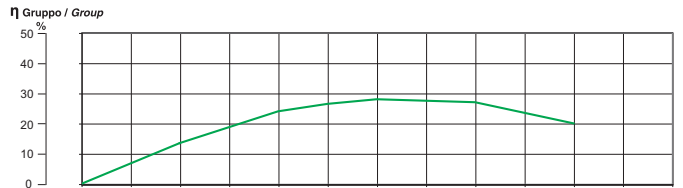
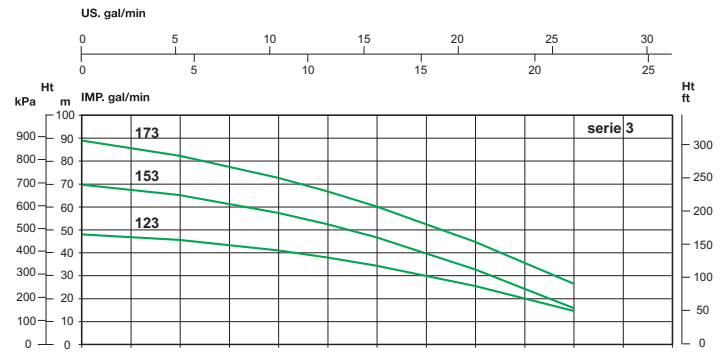

min⁻¹ ~ 2900

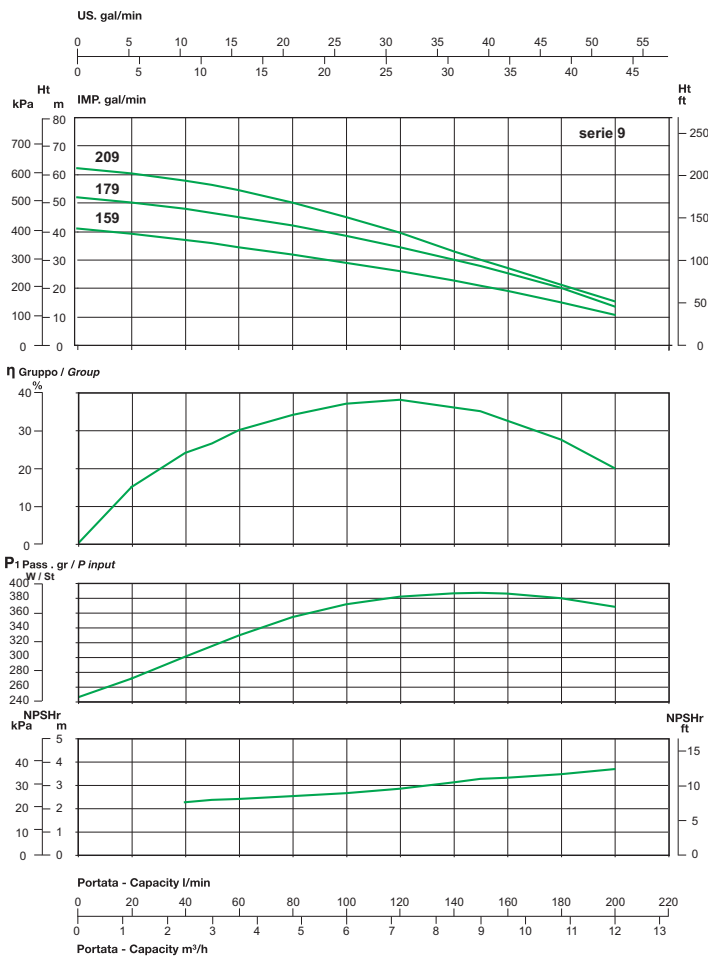

min⁻¹ ~ 3400

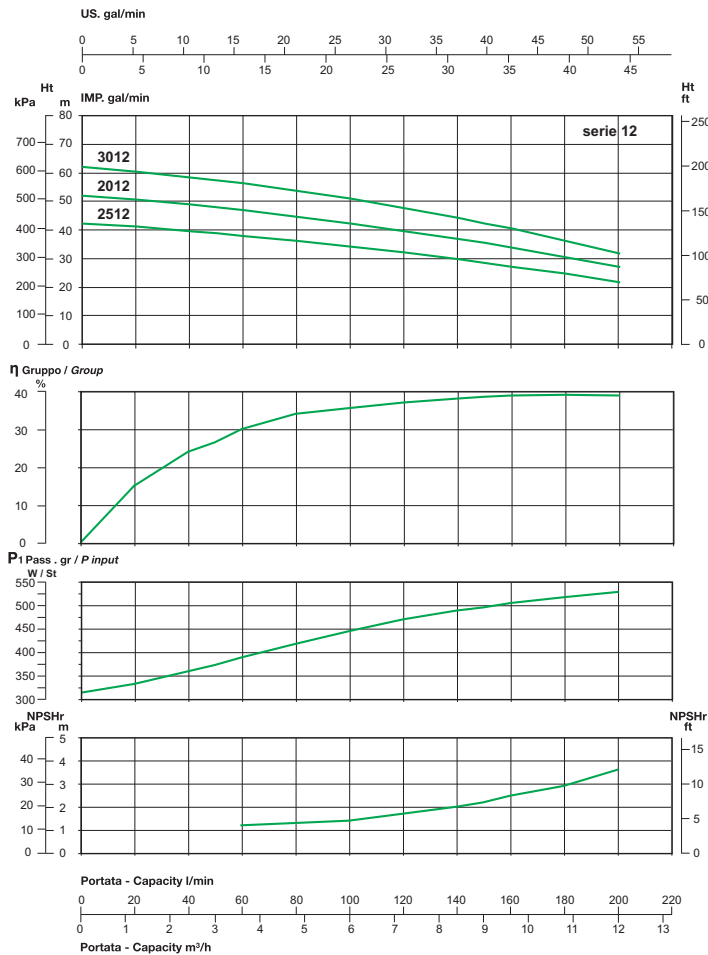
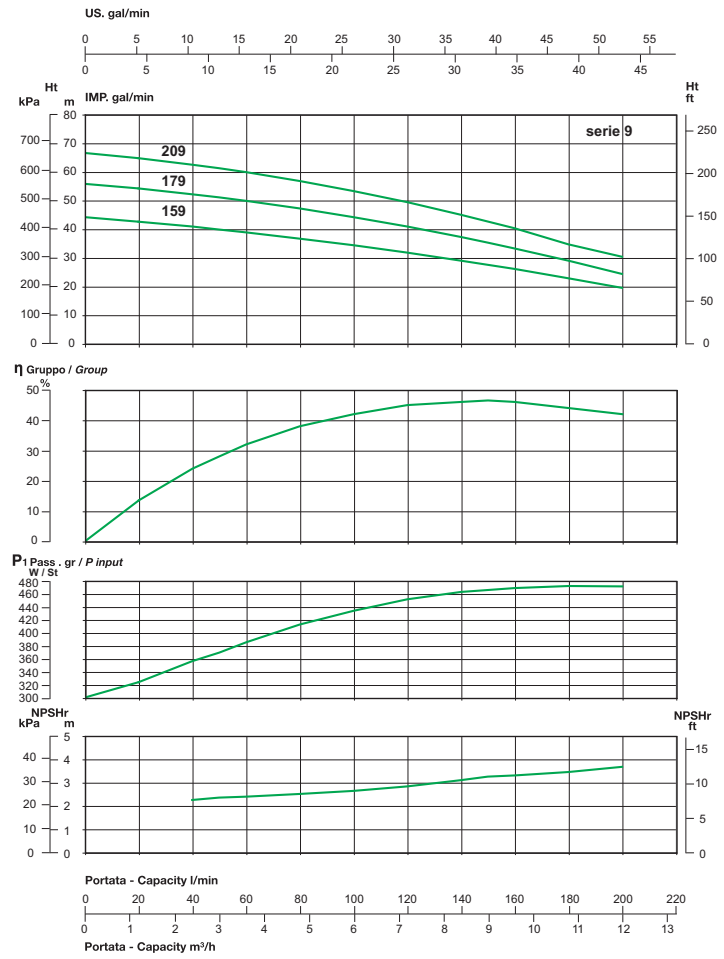

"TEAM"

■ GRUPPI DI PRESSURIZZAZIONE AUTOMATICI

IMPIEGHI

I gruppi di pressurizzazione automatici della serie "TEAM" sono stati progettati per mantenere costantemente in pressione piccoli o medi impianti idrici civili, industriali o d'irrigazione. Vengono forniti già assemblati e pronti per l'installazione. E' possibile scegliere la soluzione più adatta alle esigenze dell'impianto, tramite la selezione dell'elettropompa in base alla portata e curva di lavoro; è anche possibile scegliere il gruppo in base alle caratteristiche degli stessi. E' importante ricordare che il gruppo di pressurizzazione deve essere dimensionato in funzione della quantità d'acqua e della pressione richiesta.

SCelta DEL GRUPPO DI PRESSURIZZAZIONE PER FABBISOGNO IDRICO

Edifici ad uso residenziale

Gli elementi principali per il calcolo del fabbisogno d'acqua sono:

- il consumo per ogni tipologia di erogazione (tab. 1)
- il numero di utenze (tab. 2)
- il fattore di contemporaneità:

Il massimo fabbisogno teorico è dato dalla somma delle portate per tipologia di erogazione di un appartamento e per il numero di essi.

In pratica si verifica che soltanto una parte delle utenze vengono utilizzate contemporaneamente.

Il fattore di contemporaneità permette di definire la massima portata effettiva che può essere richiesta dalle utenze.

Edifici ad uso non residenziale

Per il calcolo del fabbisogno, prendiamo in considerazione i seguenti edifici:

- uffici
- centri commerciali
- strutture ospedaliere
- hotel

Scelta del gruppo di pressurizzazione per prevalenza / pressione

La pressione agli utilizzi necessaria per un corretto funzionamento di elettrodomestici e sprinklers, non deve essere inferiore a 1,5 bar e normalmente non superiore a 4-5 bar. Gli elementi da considerare per il calcolo della pressione sono:

- dislivello geodetico tra il gruppo ed il punto di erogazione più elevata
- l'altezza di aspirazione
- la pressione iniziale (o battente positivo)
- la pressione residua minima all'utilizzo più elevato (normalmente 1,5 bar)
- le perdite di carico dell'impianto
- la differenza di pressione fra avviamento e arresto pompe.



AUTOMATIC PRESSURE SYSTEMS

APPLICATIONS

The automatic pressure systems series "TEAM" have been designed for keeping a constant water pressure on small or medium domestic, industrial or irrigation plants. These pressure systems are supplied already assembled and ready for installation. It is possible to choose the most suitable solution for the plant's necessities through the selection of the electrical pump based on the capacity and the working curve. It is also possible to choose the pressure system for its own characteristics. It is important to remind that the size of the pressure system is determined by the quantity of water and pressure required.

CHOOSING A PRESSURE SYSTEM PER WATER NEEDS

Residential buildings

The main data needed for calculation of the water needs are given as following:

- the typology of distribution (tab. 1)
 - consumption per numbers of outlet (tab.2)
 - the simultaneity factor:
- The maximum theoretical requirement is given by the sum of the quantities of water delivered to the various typologies of distribution and flats multiplied by the number of them. In practice, it is generally found that only some of the outlets are used simultaneously. The simultaneity factor allows to define the real maximum delivery that may be required by the typology of distribution.

Non-residential buildings

For calculation of quantities of water required the following types of buildings are considered:

- offices
- shopping centres
- hospitals
- hotels

Choosing a pressure system per delivery head / pressure

The outlet pressure required for proper operation of electrical appliances & sprinklers must not be lower than 1,5 bar and usually not greater than 4-5 bar. The values to consider for pressure level calculation are the following:

- the geodetic head between the pressure boosting unit and the highest outlet
- the suction lift
- the initial pressure (or positive suction head)
- the minimum residual pressure at the highest outlet (normally 1.5 bar)
- the system head loss
- the difference in pressure between starting and stopping pump

GROUPES DE PRESSURISATION AUTOMATIQUES

EMPLOIS

Les groupes de pressurisation automatiques de la série "TEAM" ont été conçus pour maintenir constamment sous pression de petites ou moyennes installations hydriques civiles, industrielles ou d'irrigation. Ils sont fournis déjà assemblés et prêts pour l'installation. Il est possible de choisir la solution la plus adaptée aux exigences de l'installation, au moyen de la sélection de l'électropompe sur la base du débit et de la courbe de travail ; il est également possible de choisir le groupe sur la base des caractéristiques de ceux-ci. Il est important de se rappeler que le groupe de pressurisation doit être dimensionné en fonction de la quantité d'eau et de la pression demandée.

CHOIX DU GROUPE DE PRESSURISATION PAR BESOINS HYDRIQUES

Bâtiments à usage résidentiel

Les éléments principaux pour le calcul des besoins en eau sont :

- la consommation pour chaque type de distribution (tab. 1)
- le nombre d'utilisations (tab. 2)
- le facteur de simultanéité :

Les besoins maximaux théoriques sont donnés par la somme des plages d'utilisation par type de distribution d'un appartement et par le nombre de ceux-ci. En pratique on vérifie que seulement une partie des utilisations sont utilisées en même temps. Le facteur de simultanéité permet de définir le débit maximal effectif qui peut être demandé par les utilisations.

Bâtiments à usage non résidentiel

Pour le calcul des besoins, nous prenons en considération les bâtiments suivants :

- bureaux
- centres commerciaux
- structures hospitalières
- hôtels

Choix du groupe de pressurisation par hauteur/ pression

La pression aux utilisations nécessaires pour un fonctionnement correct d'appareils ménagers et de sprinklers, ne doit pas être inférieure à 1,5 bar et normalement pas supérieure à 4-5 bars. Les éléments à prendre en compte pour le calcul de la pression sont :

- dénivelée géodésique entre le groupe et le point de distribution le plus élevée
- la hauteur d'aspiration
- la pression initiale (ou battant positif)
- la pression résiduelle minimale à l'utilisation la plus élevée (normalment 1,5 bar)
- les pertes de charges de l'installation
- la différence de pression entre démarrage et arrêt pompe.

GRUPOS DE PRESURIZACIÓN AUTOMÁTICOS

USOS

Los grupos de presurización automáticos de la serie "TEAM" han sido proyectados para mantener a presión constante pequeñas o medianas sistemas hídricos civiles, industriales o de irrigación. Vienen ya ensamblados y listos para su instalación. Es posible elegir la solución más adecuada a las exigencias de la instalación, seleccionando la electrobomba teniendo en cuenta el caudal y la curva de trabajo; además puede elegirse el grupo según las características de los mismos. Es importante recordar que el tamaño del grupo de presurización depende de la cantidad de agua y de la presión requeridas.

ELECCIÓN DEL GRUPO DE PRESURIZACIÓN CONSIDERANDO LAS NECESIDADES HÍDRICAS

Edificios de uso residencial

Los elementos principales para el cálculo de las necesidades de agua son:

- el consumo para cada tipo de suministro (tab. 1)
- el número de usuarios (tab. 2)
- el factor de contemporaneidad:

El máximo necesidad teórico se obtiene sumando los caudales por tipo de su ministro de un apartamento y por el número de estos. En la práctica se verifica que sólo una parte de los consumos son utilizados contemporaneamente. El factor de contemporaneidad permite definir el máximo caudal efectivo que los usuarios pueden requerir.

Edificios de uso no residencial

Para calcular las necesidades, tomemos en consideración los siguientes edificios:

- oficinas
- centros comerciales
- estructuras hospitalarias
- hoteles

Elección del grupo de presurización según altura / presión

La presión necesaria para un correcto funcionamiento de electrodomésticos y rociadores no debe ser inferior a 1,5 bar y normalmente no superior a 4-5 bar. Los elementos a considerar para el cálculo de la presión son:

- desnivel geodésico entre el grupo y el punto de suministro más elevado
- la altura de aspiración
- la presión inicial (o presión negativa)
- la presión residual mínima al uso más elevado (normalmente 1,5 bar)
- la pérdida de carga de la instalación
- la diferencia de presión entre arranque y parada de las bombas.

tab. 1

Prelievo per tipologia di erogazione Used per typology of distribution	Portata [l/1'] Capacity
Bidè - Bidet - Bibet - Bibet	6
Lavabo - Washbasin - Lavabo - Lavabo	6
WC a cassetta - WC with flushing tank duties - WC de fonctions Quick Step - WC de paso rápido	6
Lavandino - Sink/Washbasin - Puits - Fregadero	9
Lavastoviglie - Dishwasher - Lave-vaisselle - Lavavajillas	10
Doccia - Shower - Douche - Ducha	12
Lavatrice - Washing machine - Machine à laver - Lavadero	12
Vasca da bagno - Bath (tub) - Baignoire - Bañera	15
WC a passo rapido - WC with quick step duties - WC de fonctions Quick Step - WC de paso rápido	90

tab. 2

N° appartamenti Flats Apartments Pisos	Portata alla massima contemporaneità [l/1'] - Capacity at the max. simultaneity Capacités au max. simultanéité - Capacidad en el máxima simultaneidad					
	WC con cassetta - WC with flushing tank duties Toilette à cassette - Bagno con cisterna			WC con passo rapido - WC with quick step duties WC de fonctions Quick Step - WC de paso rápido		
	1 WC	2 WC	3 WC	1 WC	2 WC	3 WC
1	32	40	50	61	79	84
2	45	56	70	86	112	118
3	55	69	86	105	137	145
4	63	79	100	121	158	167
5	71	88	111	136	177	187
6	78	97	122	149	194	205
8	90	112	141	172	224	236
10	100	125	158	192	250	264
15	123	153	193	235	307	324
20	142	177	223	271	354	374
25	158	198	249	303	396	418
30	173	217	273	332	434	458
35	187	234	295	359	469	494
40	200	250	315	384	501	529
45	212	265	334	407	531	561
50	224	280	352	429	560	591
60	245	307	386	470	614	647
70	265	331	417	507	663	699
80	283	354	446	542	708	748
90	300	375	473	575	751	793
100	317	396	498	606	792	836
120	347	433	546	664	868	916
140	375	468	590	718	937	989
160	401	501	631	767	1.002	1.057
180	425	531	669	814	1.063	1.121
200	448	560	705	858	1.120	1.182
220	470	587	739	899	1.175	1.240
240	491	613	772	939	1.227	1.295
260	511	636	804	978	1.277	1.346
280	530	662	834	1.015	1.325	1.399
300	549	685	863	1.050	1.372	1.448
350	593	740	933	1.135	1.462	1.564
400	633	791	997	1.213	1.584	1.672

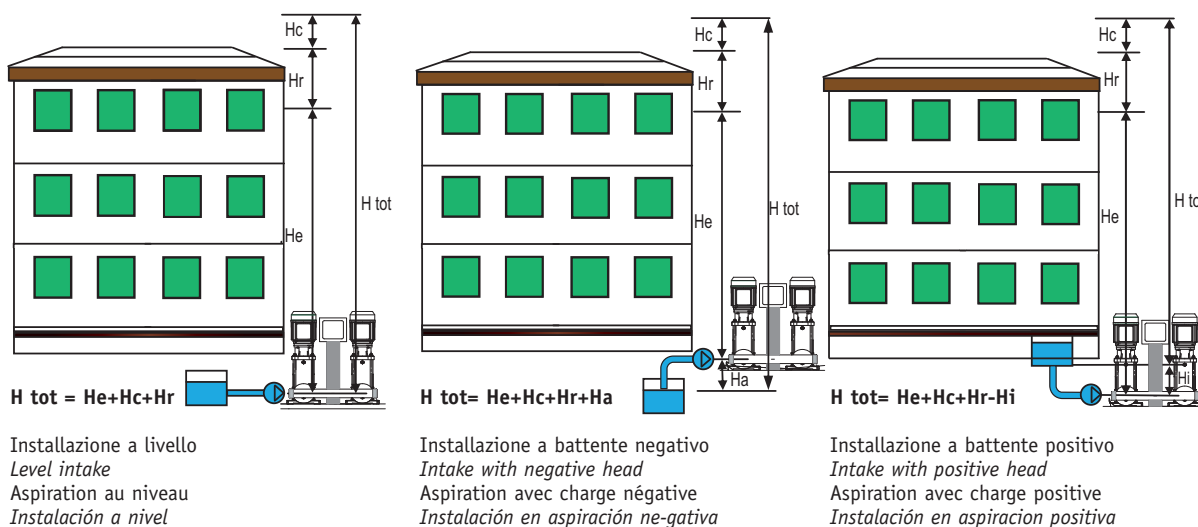

N° persone o posti letto persons or beds personnes ou les lits persona o camas	Portata alla massima contemporaneità [l/1'] - Capacity at the max. simultaneity Capacités au max. simultanéité - Capacidad en el máxima simultaneidad				
	Uffici Offices Bureaux Oficinas	Grandi Magazzini Large complexes Grandes superficies Grandes tiendas	Ospedali Hospitals	Hotel Hotels	Hotel in località turistiche Hotels in holiday resorts Centres de villégiature Resorts
15	7	41	45	99	118
20	9	43	55	116	140
25	12	55	65	134	161
30	15	61	74	151	182
35	18	68	84	169	202
40	20	74	93	186	223
45	23	81	103	203	243
50	26	87	113	220	263
60	31	100	131	253	303
70	36	112	150	285	342
80	41	125	169	317	381
90	46	137	188	349	418
100	51	148	206	379	455
120	61	172	243	439	527
140	70	194	279	497	596
160	79	216	314	553	663
180	87	237	349	606	727
200	96	257	384	658	789
250	116	305	468	779	935
300	134	349	549	889	1.067
350	151	390	627	990	1.188
400	166	428	702	1.082	1.298
450	181	463	774	1.166	1.399
500	194	495	843	1.243	1.492
600	220	552	974	1.381	1.657
700	243	601	1.095	1.501	1.801
800	265	645	1.206	1.608	1.930
1000	310	721	1.402	1.803	2.163
1200	358	788	1.569	1.992	2.390
1400	413	853	1.714	2.189	2.626
1600	476	920	1.843	2.395	2.874
1800	546	988	1.965	2.600	3.120
2000	621	1.054	2.089	2.778	3.333

“TEAM EXPORT”



“CONTROL TEAM”



GRUPPI DI PRESSURIZZAZIONE AUTOMATICI CON SERBATOIO ORIZZONTALE

Con il TEAM EXPORT si può ottimizzare la giusta riserva d'acqua, mantenendo costantemente in pressione l'impianto e limitando il numero di avviamenti dell'elettropompa.

I gruppi autoclave TEAM EXPORT sono composti da un'elettropompa centrifuga o autoadescante, serbatoio orizzontale in acciaio verniciato con membrana adatta per usi alimentari (non alcolici), disponibile con capacità da 20 l., 40 l., 60 l., 80 l., 100 l., 200 l., pressostato già opportunamente tarato, manometro, tubo flessibile e raccordo 3 o 5 vie in ottone.

- Alimentazione: disponibile in monofase e trifase a 50 o 60 Hz
- Massima pressione di utilizzo: 10 bar
- Massima temperatura del liquido: 35 °C per uso domestico (CEI EN 60335-2-41) o 60 °C per altri usi
- Massima temperatura ambiente: 40 °C

GROUPES DE PRESSURISATION AUTOMATIQUES AVEC RÉSERVOIR HORIZONTAL

Avec le TEAM EXPORT on peut optimiser la réserve d'eau adéquate, en maintenant constamment sous pression l'installation et en limitant le nombre de mises en route de l'électropompe.

Les groupes autoclaves TEAM EXPORT sont composés d'une électropompe centrifuge ou autoamorçante, un réservoir horizontal en acier peint avec une membrane adaptée aux usages alimentaires (non alcooliques), disponible avec capacités de 20 l., 40 l., 60 l., 80 l., 100 l., 200 l., pressostat déjà opportunément taré, manomètre, tuyau flexible et raccord 3 ou 5 voies en laiton.

- Alimentation : disponible monophasée et triphasée à 50 ou 60 Hz
- Pression d'utilisation maximale : 10 bars
- Température maximale du liquide : 35 °C pour utilisation domestique (CEI EN 60335-2-41) ou 60 °C pour d'autres utilisations
- Maximum température ambiante : 40 °C

GRUPPI DI PRESSURIZZAZIONE ELETTRONICI

Il "CONTROL TEAM" è un sistema elettronico che fa funzionare l'elettropompa ad ogni richiesta d'acqua nell'impianto, mantenendo il flusso e la pressione costante. Inoltre uno speciale dispositivo permette di fermare la pompa in caso di mancanza d'acqua.

I gruppi automatici sono composti da un'elettropompa centrifuga o autoadescante, accoppiata al sistema FORMULA PRESS (sistema elettronico di controllo) con manometro, pressostato e valvola di ritegno già incorporata.

- Alimentazione: disponibile in monofase a 50 o 60 Hz
- Corrente massima: 16 (8) A
- Portata massima: 160 l/1'
- Pressione di avviamento: 1,5 bar
- Pressione minima pompa: 2,5 bar
- Pressione massima: 10 bar
- Funzione reset automatico
- Massima temperatura del liquido: 35 °C per uso domestico (CEI EN 60335-2-41) o 60 °C per altri usi
- Massima temperatura ambiente: 40 °C

GROUPES DE PRESSURISATION ÉLECTRONIQUES

Le "CONTROL TEAM" est un système électronique qui fait fonctionner l'électropompe à chaque demande d'eau dans l'installation, en maintenant le débit et la pression constante. De plus un dispositif spécial permet d'arrêter la pompe en cas de manque d'eau.

Les groupes automatiques sont composés d'une électropompe centrifuge ou autoamorçante, accouplée au système FORMULA PRESS (système électronique de contrôle) avec manomètre, pressostat et clapet de non-retour incorporé.

- Alimentation : disponible monophasée à 50 ou 60 Hz
- Courant maximum : 16 (8) A
- Débit maximum : 160 l/1'
- Pression de départ : 1,5 bar
- Pompe de pression minimum : 2,5 bar
- Pression maximale : 10 bars
- Fonction réarmement automatique
- Température maximale du liquide : 35 °C pour utilisation domestique (CEI EN 60335-2-41) ou 60 °C pour d'autres utilisations
- Température maximale ambiante : 40 °C

AUTOMATIC PRESSURE SYSTEMS WITH HORIZONTAL PRESSURE TANK

With the utilisation of the TEAM EXPORT it is possible to achieve the right water reserve, maintaining the plant constantly under pressure and restricting the electrical pumps' starting numbers.

The automatic pressure systems series "TEAM EXPORT" are composed either of a centrifugal or a self-priming electrical pump, a painted steel horizontal tank with diaphragm suitable for drinking liquids (no alcohol), availability capacities: 20 l., 40 l., 60 l., 80 l., 100 l., 200 l., a pressure switch already adjusted, pressure gauge, flexible hose and 3 or 5 ways connection in stamped brass.

- Feeding: available in single-phase or three-phase at 50 or 60 Hz
- Maximum excess operating pressure: 10 bar
- Maximum water temperature: 35 °C for domestic use (CEI EN 60335-2-41) or 60 °C for other use
- Maximum ambient temperature: 40 °C

GRUPOS DE PRESURIZACIÓN AUTOMÁTICOS CON DEPÓSITO HORIZONTAL

Con el TEAM EXPORT es posible optimizar la justa reserva de agua, manteniendo constantemente a presión la instalación y limitando el número de veces que debe arrancar la electrobomba.

Los grupos autoclave TEAM EXPORT se componen de una electrobomba centrifuga o autocebante, depósito horizontal de acero barnizado con membrana apta para usos alimentarios (no alcohólicos), disponible con capacidad de 20 l., 40 l., 60 l., 80 l., 100 l., 200 l., presostato ya convenientemente calibrado, manómetro, manguera flexible y empalme 3 o 5 vías de latón.

- Alimentación: disponible monofásico y trifásico a 50 o 60 Hz
- Máxima presión de uso: 10 bar
- Máxima temperatura del líquido: 35 °C para uso doméstico (CEI EN 60335-2-41) o 60 °C para otros usos
- Máxima temperatura ambiente: 40 °C

ELECTRONIC PRESSURE SYSTEMS

The CONTROL TEAM is an electronic system that starts up the electric pump when there is water required in the plant, keeping a constant pressure and flow. Moreover, a special mechanism controls the stop of the pump in case of dry running.

The automatic system "FORMULA PRESS" is composed of a centrifugal or a self-priming electrical pump combined with the "CONTROL PUMP", an electronic control system, with pressure gauge, pressure switch and no return valve included.

- Feeding: available in single-phase at 50 or 60 Hz
- Current maximum: 16 (8) A
- Maximum capacity: 160 l/1'
- Starting pressure: 1,5 bar
- Minimum pressure pump: 2,5 bar
- Maximum pressure: 10 bar
- Automatic reset function
- Maximum water temperature: 35 °C for domestic use (CEI EN 60335-2-41) or 60 °C for other use
- Maximum ambient temperature: 40 °C

GRUPOS DE PRESURIZACIÓN ELECTRÓNICOS

El "CONTROL TEAM" es un sistema electrónico que pone en funcionamiento la electrobomba con cada pedido de agua en la instalación, manteniendo el flujo y la presión constantes. Además un dispositivo especial permite detener la bomba en caso de ausencia de agua.

Los grupos automáticos se componen de una electrobomba centrifuga o autocebante, acoplada al sistema FORMULA PRESS (sistema electrónico de control) con manómetro, presostato y válvula de retención ya incorporada.

- Alimentación: disponible en monofásico a 50 o 60 Hz
- Actuales máxima: 16 (8) A
- Caudal máximo: 160 l/1'
- Presión inicial: 1,5 bar
- Bomba de presión mínima: 2,5 bar
- Presión máxima: 10 bar
- Función de rearme automático
- Máxima temperatura del líquido: 35 °C para uso doméstico (CEI EN 60335-2-41) o 60 °C para otros usos
- Máxima temperatura ambiente: 40 °C

"INVENTApress"



ELETTROPOMPE A VELOCITA' VARIABILE

"INVENTApress" è elettropompe a velocità variabile comandata da un convertitore di frequenza tipo "INVENTA" basato su tecnologia INVERTER. Integrato direttamente sul motore, il convertitore di frequenza permette di regolare la velocità della pompa in modo da fornire la pressione costante al variare della portata richiesta.

Principali vantaggi :

- Silenziosità e confort ;
- Risparmio energetico;
- Protezioni del motore e dell'impianto
- Minor usura della pompa durante il funzionamento grazie all'avvio modulato "soft start"
- Correnti di spunto ridotte.

CARATTERISTICHE COSTRUTTIVE

"INVENTApress" è composto da un'elettropompa tipo "MKV", accoppiato al sistema "INVENTA" completo di trasduttore di pressione.

- Grado di protezione IP54
- Temperatura ambiente da +0°C a + 40°C
- Filtro d'ingresso conforme alla direttiva EMC
- Connettività Interfaccia seriale RS 485
- Possibilità di collegamento a cascata fino a 6 pompe

ÉLECTROPOMPES À VITESSE VARIABLE

"INVENTApress" sont des électropompes à vitesse variable commandées par un convertisseur de fréquence type "INVENTA" basées sur technologie INVERTER. Intégré sur le moteur, le convertisseur de fréquence permet de régler la vitesse de la pompe de façon à fournir une pression constante malgré la variation du débit demandé.

Principaux avantages :

- Silence et confort ;
- Économie d'énergie ;
- Protections du moteur et de l'installation
- Usure moindre de la pompe pendant le fonctionnement grâce au démarrage modulé "soft start"
- Courants initiaux de démarrage réduits.

CARACTÉRISTIQUES DE CONSTRUCTION

"INVENTApress" est composé d'une électropompe type "MKV", accouplée au système "INVENTA" muni d'un transducteur de pression.

- Degré de protection IP54
- Température ambiante de +0°C à + 40°C
- Filtre d'entrée conforme à la directive EMC
- Connectivité Interface sérielle RS 485
- Possibilité de raccordement en cascade jusqu'à 6 pompes

VARIABLE SPEED ELECTRIC PUMPS

"INVENTApress" are variable speed electric pumps driven by frequency converter type "INVENTA" based on INVERTER technology. Directly integrated on the motor, the frequency converter permits the speed control of the pump so as keep the constant pressure to varying of the demanded flow.

Main advantages :

- Noiseless and comfort;
- Energetic saving;
- Motor & system protection
- Minor mechanical stress during the operation thanks to the soft start
- Reduced starting currents.

TECHNICAL FEATURES

"INVENTApress" is composed either of a "MKV" pump, coupled to the system "INVENTA" suit of pressure transducer.

- Protection IP54
- Ambient temperature +0°C a + 40°C
- Input filter in compliance with EMC directive
- Interface connections port RS 485
- Multipurpose connection up to 6 pumps

ELECTROBOMBAS A VELOCIDAD VARIABLE

"INVENTApress" es un sistema de electrobombas a velocidad variable controladas por un convertidor de frecuencia tipo "INVENTA" basado en la tecnología INVERTER. Integrado directamente en el motor, el convertidor de frecuencia permite regular la velocidad de la bomba de manera que se mantenga la presión constante no obstante las variaciones del caudal requerido.

Principales ventajas :

- Silencioso y confortable;
- Ahorro energético;
- Protección del motor y de la instalación
- Menor usura de la bomba durante el funcionamiento gracias a la puesta en marcha modulada "soft start"
- Corrientes de arranque reducidas.

CARACTERÍSTICAS DE CONSTRUCCIÓN

"INVENTApress" se compone de una electrobomba tipo "MKV", acoplada al sistema "INVENTA" y dotado de un transductor de presión.

- Grado de protección IP54
- Temperatura ambiente desde +0°C a + 40°C
- Filtro de entrada conforme a la directiva EMC
- Conectividad Interfaz serial RS 485
- Posibilidad de conexión en cascada con hasta 6 bombas

TIPO TYPE	Potenza nominale Nominal power		Potenza assorbita Input power		Corrente assorbita Input current		Portata - Capacity																	
							Prevalenza (m C.A.) Total head (m W.C.)																	
							Q [m ³ /h]	0	2,4	3	3,6	4,8	6	8,4	9	9,6	10,8	12	15					
Versione Monofase - Single phase Version 230V							Q [l/s]	0	40	50	60	80	100	140	150	160	180	200	250					
Versione Trifase - Three phase Version 400V																								
INVENTApress MKV 3/10	1,1	1,5	1820	5,2	-																			
INVENTApress MKV 3/12	1,47	2	2060	6,6	-																			
INVENTApress MKV 3/15	1,85	2,5	2660	7,6	-																			
INVENTApress MKV 6/6	1,1	1,5	1840	5,0	-																			
INVENTApress MKV 6/7	1,47	2	2080	6,2	-																			
INVENTApress MKV 6/9	1,85	2,5	2630	7,6	-																			
INVENTApress MKV 9/5	1,1	1,5	1840	5,3	-																			
INVENTApress MKV 9/6	1,47	2	2100	6,8	-																			
INVENTApress MKV 9/7	1,85	2,5	2430	7,7	-																			
INVENTApress MKV 3/17	2,2	3	2980	-	5,2																			
INVENTApress MKV 6/10	2,2	3	2730	-	4,7																			
INVENTApress MKV 6/12	3	4	3480	-	6,4																			
INVENTApress MKV 9/10	3	4	3580	-	5,8																			
INVENTApress MKV 12/5	1,85	2,5	2670	-	4,6																			
INVENTApress MKV 12/6	2,2	3	3100	-	5,2																			

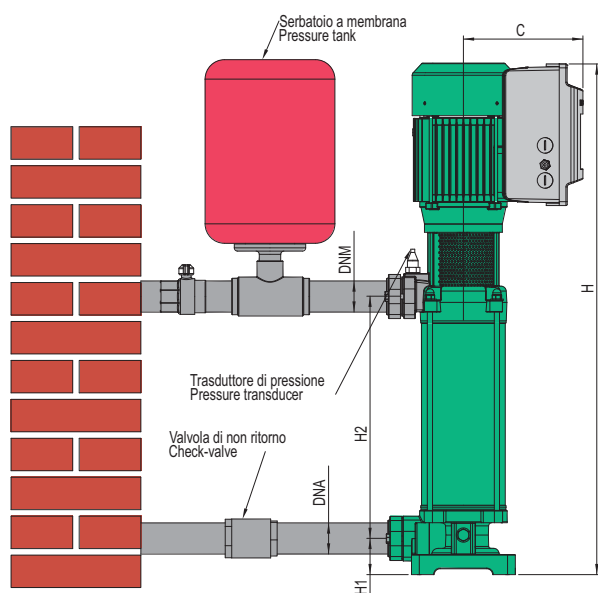

Riduzione dei consumi elettrici fino a 70%
Pressione costante
Riduzione dei problemi meccanici delle pompe

Saving energy consumption up to 70%
Constant pressure
Saving mechanical problem of the pump

Réduction des consommations électriques jusqu'à 70%
Pression constante
Réduction des problèmes mécaniques des pompes

Reducción del consumo eléctrico hasta un 70%
Presión constante
Reducción de los problemas mecánicos de las bombas

TIPO TYPE	DIMENSIONI [mm] DIMENSIONS [mm]					IMBALLO [mm] PACKINGS [mm]			PESO WEIGHT [kg]	
	C	H	H1	H2	DNA	DNM	A	L		P
INVENTApress MKV 3/10	180	758	62	412,5	1"1/4	1"1/4	1000	207	256	30,5
INVENTApress MKV 3/12	180	806,8	62	461			1240	207	256	32,5
INVENTApress MKV 3/15	180	892	62	534,5			1240	207	256	35,5
INVENTApress MKV 3/17	180	940,5	62	583			1240	207	256	36,8
INVENTApress MKV 6/6	180	661	62	316			800	207	256	27,7
INVENTApress MKV 6/7	180	685	62	339			1000	207	256	29,3
INVENTApress MKV 6/9	180	745,5	62	388			1000	207	256	32,3
INVENTApress MKV 6/10	194	770	62	412,5			1000	207	256	32,5
INVENTApress MKV 6/12	194	873	62	461			1240	400	256	37,5
INVENTApress MKV 9/5	180	720	62	365			800	207	256	27,3
INVENTApress MKV 9/6	180	760	62	404	800	207	256	28,5		
INVENTApress MKV 9/7	180	800	62	443	1000	207	256	30,9		
INVENTApress MKV 9/10	194	1000	62	562	1240	400	256	0		
INVENTApress MKV 12/5	180	720	62	365	800	207	256	27,3		
INVENTApress MKV 12/6	180	760	62	404	800	400	256	28,5		

"TEAM PRESS 2"



GRUPPI DI PRESSURIZZAZIONE AUTOMATICI

TEAM PRESS (TP) sono gruppi di pressurizzazione a più pompe con funzionamento automatico, comandato da apposito quadro elettrico collegato a pressostati. I gruppi di pressurizzazione automatici "Team Press" sono costituiti, oltre che dalle pompe, da:

- Quadro di protezione e comando collegato ai pressostati
- Basamento
- Collettori di aspirazione (ad esclusione dei gruppi con elettropompe tipo "CN 65")
- Valvola di ritegno, valvola sezionatrice ed attacco per eventuali alimentatori d'aria in aspirazione a ciascuna pompa (ad esclusione dei gruppi con elettropompe tipo "CN 65")
- Collettore di mandata con attacchi per eventuali autoclavi verticali a membrana
- Valvola sezionatrice in mandata a ciascuna pompa
- Manometro
- Avviamento stella triangolo 400V / 50 Hz per pompe di potenza superiore a 7,5kW

GROUPES DE PRESSURISATION AUTOMATIQUES

TEAM PRESS (TP) sont des groupes de pressurisation à plusieurs pompes avec un fonctionnement automatique, commandé par un panneau électrique spécial raccordé à des pressostats.

Les groupes de pressurisation automatiques "Team Press" sont constitués, en plus des pompes, de :

- Panneau de protection et de commande raccordé aux pressostats
- Socle
- Collecteurs d'aspiration (à l'exclusion des groupes avec électropompes type "CN 65")
- Clapet de non-retour, vanne de sectionnement et prise pour d'éventuels alimentateurs d'air en aspiration à chaque pompe (à l'exclusion des groupes avec électropompes type "CN 65")
- Collecteur de refoulement avec prises pour d'éventuels autoclaves verticaux à membrane
- Vanne de sectionnement en refoulement à chaque pompe
- Manomètre
- Démarrage étoile triangle 400V / 50 Hz pour pompes de puissance supérieure à 7,5kW



AUTOMATIC PRESSURE SYSTEMS

TEAM PRESS (TP) are pressure booster sets with more than one pump and with automatic duty controlled by a special control panel connected to pressure switches. The automatic pressure booster sets "Team Press" besides the pumps are consisting of:

- Control panel connected to the pressure switches
- Base frame
- Suction manifold (excluding the booster sets with electric pump type "CN 65").
- Check valve, ball valve and connection for possible air feedings in suction to each pump (excluding the booster sets with electric pump type "CN 65")
- Outlet manifold with connections for eventual vertical pressure tanks
- Outlet ball valve on each pump
- Pressure gauge/
- Delta starting 400 V / 50 Hz for pumps over than 7,5kW.

GRUPOS DE PRESURIZACIÓN AUTOMÁTICOS

TEAM PRESS (TP) son grupos de presurización de varias bombas con funcionamiento automático, controlado mediante el correspondiente cuadro eléctrico conectado a presostatos. Los grupos de presurización automáticos "Team Press" están constituidos, además de las bombas, de:

- Cuadro de protección y control conectado con los presostatos
- Soporte
- Colectores de aspiración (con exclusión de los grupos con electrobombas tipo "CN 65")
- Válvula de retención, válvula de corte y acometida para eventuales alimentadores de aire en aspiración de cada una de las bombas (con exclusión de los grupos con electrobombas tipo "CN 65")
- Colector de descarga con acometidas para eventuales autoclaves verticales de membrana
- Válvula de corte en descarga mandata en cada bomba
- Manómetro
- Arranque estrella triángulo 400V / 50 Hz para bombas de potencia superior a 7,5kW

TIPO TYPE	Potenza nominale Nominal power [kW] [HP]		Portata - Capacity																	
			Q [m³/h]																	
			0	2.4	4.8	6	9.6	12	18	24	36	48	60	72	84	96	120	144	168	204
			Q [l/v]																	
			0	40	80	100	160	200	300	400	600	800	1000	1200	1400	1600	2000	2400	2800	3400
			Prevalenza (m C.A.) Total head (m W.C.)																	
TP2 MJX 83	2 x	0,59 0,8	41,0	33,8	27,3	23,4	10,4													
TP2 MJX 103	2 x	0,74 1	57,8	52,1	46,1	41,1	20,9													
TP2 MJX 123	2 x	0,88 1,2	70,6	61,7	51,1	44,1	20,2													
TP2 MJX 106	2 x	0,74 1	43,0	40,0	36,2	34,1	27,0	21,5	5,1											
TP2 MJX 126	2 x	0,88 1,2	52,1	47,8	43,7	41,2	32,2	25,2	4,3											
TP2 JET 102	2 x	0,74 1	49,5	37,9	28,9	25,4														
TP2 JET 122	2 x	0,88 1,2	54,0	43,6	33,5	28,7														
TP2 JET 202	2 x	1,47 2	54,0	49,5	46,5	43,0	37,0	32,0												
TP2 JET 302	2 x	2,2 3	60,0	55,0	52,3	50,0	42,0	39,0												
TP2 JEXI 101	2 x	0,74 1	46,2	33,0	23,9	20,9														
TP2 JEXI 121	2 x	0,88 1,2	51,3	41,4	31,8	27,3														
TP2 JB 150	2 x	1,1 1,5	65,6	62,0	56,5	53,1	40,1													
TP2 JB 200	2 x	1,47 2	60,9	58,7	55,4	53,3	45,5	38,9												
TP2 JB 300	2 x	2,2 3	59,4	58,7	57,0	55,8	50,8	46,2	30,6											
TP2 K 100	2 x	0,74 1	33,0	32,0	30,5	28,5	25,0	20,5												
TP2 K 151	2 x	1,1 1,5	41,0	40,4	40,0	38,0	36,8	33,5	20,0											
TP2 K 200	2 x	1,47 2	47,4	47,3	46,5	45,8	42,6	39,4	28,1											
TP2 K 300	2 x	2,2 3	52,9	52,8	52,1	51,5	48,6	45,7	35,4											
TP2 KC 300	2 x	2,2 3	35,5	34,4	33,4	32,8	31,4	30,4	28,2	26,3	23,1	20,9								
TP2 BK 100	2 x	0,74 1	43,5	41,0	35,0	30,0	14,0													
TP2 BK 150	2 x	1,1 1,5	48,0	47,0	43,5	42,2	36,8	33,0	16,0											
TP2 BK 200	2 x	1,47 2	54,5	53,5	51,0	49,7	43,0	38,5	20,0											
TP2 BK 300	2 x	2,2 3	60,0	60,0	57,0	55,0	50,0	46,0	29,5											
TP2 BK 400	2 x	3 4	66,0	65,5	65,0	63,4	61,5	58,0	50,5	42,0										
TP2 BK 550	2 x	4 5,5	79,5	79,2	79,0	78,4	78,0	72,0	65,0	56,0										
TP2 BK 750	2 x	5,5 7,5	89,0	88,0	87,0	85,3	83,0	78,0	71,5	62,0										
TP2 MK 100	2 x	0,74 1	46,0	43,5	38,5	35,0	23,5													
TP2 MK 120	2 x	0,88 1,2	58,0	54,0	48,0	42,7	29,0													
TP2 MKV 3/7	2 x	0,74 1	72,5	63,2	50,8	44,2	21,9													
TP2 MKV 3/9	2 x	0,88 1,2	90,1	74,8	62,1	53,8	25,9													
TP2 MKV 3/10	2 x	1,1 1,5	103,9	91,8	75,4	65,9	31,9													
TP2 MKV 3/12	2 x	1,47 2	123,1	106,5	85,7	74,4	35,6													
TP2 MKV 6/5	2 x	0,88 1,2	59,4	57,2	51,2	48,5	38,8	30,9												
TP2 MKV 6/6	2 x	1,1 1,5	74,0	70,9	65,1	62,0	50,4	40,9												
TP2 MKV 6/7	2 x	1,47 2	86,2	80,9	74,7	70,9	57,6	46,9	14,2											
TP2 MKV 6/9	2 x	1,85 2,5	110,5	105,5	97,9	93,6	77,6	64,5	23,2											
TP2 MKV 6/10	2 x	2,2 3	122,6	115,7	106,6	101,5	83,0	68,4	23,3											
TP2 MKV 9/4	2 x	0,88 1,2	45,6	43,0	41,5	40,3	36,1	32,9	23,4											
TP2 MKV 9/5	2 x	1,1 1,5	58,2	55,1	53,0	51,6	46,6	42,9	32,2	19,5										
TP2 MKV 9/6	2 x	1,47 2	68,7	65,6	62,6	60,8	54,7	50,0	35,9	19,2										
TP2 MKV 9/7	2 x	1,85 2,5	81,1	78,2	74,1	72,1	65,8	61,2	46,8	26,6										
TP2 MKV 9/10	2 x	3 4	107,8	102,5	98,1	95,2	85,2	77,6	54,9	27,1										
TP2 MKV 12/5	2 x	1,85 2,5	54,3	53,5	52,7	52,2	50,1	48,5	43,2	36,3	17,2									
TP2 MKV 12/6	2 x	2,2 3	61,8	60,9	59,8	59,2	56,7	54,7	48,3	40,1	21,4									
TP2 MKV 12/7	2 x	3 4	77,6	73,5	75,4	73,8	71,3	69,5	63,9	54,4	25,8									
TP2 MVX 5-5 F	2 x	1,1 1,5			50,7	49,2	41,6	36,1												
TP2 MVX 5-7 F	2 x	1,5 2			71,6	69,5	58,9	51,2												
TP2 MVX 5-8 F	2 x	2,2 3			84,1	82,0	70,4	61,8												
TP2 MVX 9-5 F	2 x	2,2 3					54,5	53,0	47,4	35,4										
TP2 MVX 9-6 F	2 x	2,2 3					64,7	62,7	55,9	41,0										
TP2 MVX 9-7 F	2 x	3 4					76,2	74,0	66,2	50,0										
TP2 MVX 9-8 F	2 x	3 4					86,3	83,6	74,6	55,6										
TP2 MVX 16-5 F	2 x	4 5,5							55,5	51,3	45,5	24,5								
TP2 MVX 16-6 F	2 x	5,5 7,5							66,6	61,3	54,6	29,3								
TP2 MVX 16-7 F	2 x	5,5 7,5							77,1	70,7	62,9	33,3								
TP2 MVX 16-8 F	2 x	5,5 7,5							87,5	79,8	71,0	37,1								
TP2 Verti 123	* 2 x	0,88 1,2	54,3	48,1	40,1	35,5	19,0													
TP2 Verti 153	* 2 x	1,1 1,5	73,4	63,3	52,0	45,9	26,0													
TP2 Verti 173	* 2 x	1,47 2	96,8	84,6	70,2	62,1	34,8	13,8												
TP2 Verti 156	* 2 x	1,1 1,5	58,1	54,3	49,7	47,0	37,7	30,4												
TP2 Verti 176	* 2 x	1,47 2	81,0	75,0	68,1	64,3	51,4	41,7	13,3											
TP2 Verti 206	* 2 x	1,85 2,5	105,1	98,7	90,7	86,0	69,7	56,8	17,4											
TP2 Verti 159	* 2 x	1,1 1,5	45,0	42,8	40,5	39,2	35,0	31,8	22,8											
TP2 Verti 179	* 2 x	1,47 2	56,9	55,0	52,5	51,1	46,1	42,3	30,5	15,7										
TP2 Verti 209	* 2 x	1,85 2,5	68,5	66,4	63,7	62,1	56,4	51,7	26,7	18,2										
TP2 Verti 2012	* 2 x	1,47 2	47,8	46,4	44,8	43,9	41,0	38,8	32,6	25,2										
TP2 Verti 2512	* 2 x	1,85 2,5	58,5	56,8	54,9	53,9	50,4	47,7	40,1	30,9										
TP2 Verti 3012	* 2 x	2,2 3	69,5	67,7	65,5	64,3	60,2	57,1	47,8	36,4										
TP2 CN 32-200 C	2 x	4 5,5						44,0	43,0	42,0	39,0	35,0	30,0							
TP2 CN 32-200 B	2 x	5,5 7,5						51,0	50,5	50,0	46,5	42,5	38,0							
TP2 CN 32-200 A	2 x	7,5 10						59,5	59,0	58,0	56,0	52,5	47,5							
TP2 CN 40-160 A	2 x	4 5,5								37,8	36,5	34,5	32,0	27,5						
TP2 CN 40-200 B	2 x	5,5 7,5								44,5	43,5	42,0	39,0	34,5						
TP2 CN 40-200 A	2 x	7,5 10								55,0	54,8	53,8	51,5	48,0						
TP2 CN 40-250 B	2 x	11 15								72,0	70,5	69,0	66,5	63,5						
TP2 CN 40-250 A	2 x	15 20								85,5	85,2	84,5	82,5	79,5						
TP2 CN 50-160 B	2 x	5,5 7,5									31,0	30,5	29,5	28,0	26,5	22,0				
TP2 CN 50-160 A	2 x	7,5 10									39,8	39,0	38,0	37,5	36,5	33,0				
TP2 CN 50-200 C	2 x	9,2 12,5									46,5	45,5	44,5	42,0	40,0	32,5				
TP2 CN 50-200 B	2 x	11 15									54,0	52,5	51,0	48,3	46,5	39,5				
TP2 CN 50-200 A	2 x	15 20									61,0	60,0	58,5	55,9	53,5	46,5				
TP2 CN 50-250 B	2 x	18,5 25									82,5	81,7	81,0	79,8	78,0	72,5				
TP2 CN 50-250 A	2 x	22 30									90,5	90,3	89,0	87,3	86,5	80,5				
TP2 CN 65-160 B	2 x	11 15													38,5	37,7	37,0	35,5	32,5	
TP2 CN 65-160 A	2 x	15 20</																		

"KUBO V-L"



GRUPPI DI PRESSURIZZAZIONE AUTOMATICI

"KUBO V-L" sono gruppi di pressurizzazione automatici composti da 2 pompe della serie Verti Line, assemblati in un armadio compatto e pronti per essere installati all'interno o all'esterno, sono di dimensioni molto contenute, e grazie alla sua struttura rendono il sistema molto silenzioso e pratico da installare.

I gruppi di pressurizzazione automatici "KUBO V-L" sono costituiti, oltre che dalle pompe, da:

- Quadro di protezione e comando collegato ai pressostati
- Collettore di aspirazione
- Valvola di ritegno, valvola sezionatrice in aspirazione a ciascuna pompa
- Collettore di mandata con attacco per un serbatoio da 8l. a membrana
- Valvola sezionatrice in mandata a ciascuna pompa
- Manometro.

GROUPES DE PRESSURISATION AUTOMATIQUES

"KUBO V-L" sont des groupes de pressurisation automatiques composés de 2 pompes de la série Verti Line, assemblés dans une armoire compacte et prêts pour être installés à l'intérieur ou à l'extérieur, ils sont de dimensions très réduites, et grâce à leur structure ils rendent le système très silencieux et pratique à installer.

Les groupes de pressurisation automatiques "KUBO V-L" sont constitués, en dehors des pompes, de :

- Panneau de protection et de commande raccordé aux pressostats
- Collecteur d'aspiration
- Clapet de non-retour, vanne de sectionnement en aspiration à chaque pompe
- Collecteur de refoulement avec prise pour un réservoir de 8l. à membrane
- Vanne de sectionnement en refoulement à chaque pompe
- Manomètre.

AUTOMATIC PRESSURE SYSTEMS

"KUBO V-L" is an automatic pressure booster sets composed by two pumps series Verti Line already assembled in to a compact cabin ready to be assembled indoor or outdoor, having a very limited dimension and thanks to the particular structure render the system noiseless and easy to install . The automatic pressure booster sets "KUBO V-L" besides the pumps are consisting of:

- Control panel connected to the pressure switches
- Suction manifold
- Check valve, ball valve and suction to each pump
- Outlet manifold with connections for one 8 l. pressure tanks
- Outlet ball valve on each pump
- Pressure gauge.

GRUPOS DE PRESURIZACIÓN AUTOMÁTICOS

"KUBO V-L" son grupos de presurización automáticos compuestos de 2 bombas de la serie Verti Line, ensambladas en un armario compacto y listos para su instalación interior o exterior, tienen unas dimensiones muy reducidas, y gracias a su estructura hacen que el sistema sea muy silencioso y práctico para su instalación.

Los grupos de presurización automáticos "KUBO V-L" están constituidos, además de por las bombas, por:

- Cuadro de protección y control conectado a los presostatos
- Colector de aspiración
- Válvula de retención, válvula de corte en aspiración para cada bomba
- Colector de descarga con acometida para un depósito de 8l. con membrana
- Válvula de corte en descarga para cada bomba
- Manómetro.

TIPO TYPE	Potenza nominale Nominal power		Q [m³/h] Q [l/min]												
	kW	HP	0	2,4	4,8	6	7,2	9,6	12	14,4	16,8	18	19,2	21,6	24
Versione Monofase - Single phase Version 230V			Prevalenza (m C.A.) Total head (m W.C.)												
KUBO V-L 123 M	2 x 0,88	2 x 1,2	54,3	48,1	40,1	35,5	30,4	19,0							
KUBO V-L 153 M	2 x 1,1	2 x 1,5	73,4	63,3	52,0	45,9	39,6	26,0							
KUBO V-L 173 M	2 x 1,47	2 x 2	96,8	84,6	70,2	62,1	53,6	34,8							
KUBO V-L 156 M	2 x 1,1	2 x 1,5	58,1	54,3	49,7	47,0	44,1	37,7	30,4	22,3	13,3				
KUBO V-L 176 M	2 x 1,47	2 x 2	81,0	75,0	68,1	64,3	60,2	51,4	41,7	31,0	19,4				
KUBO V-L 206 M	2 x 1,85	2 x 2,5	104,0	96,0	86,9	81,9	76,6	65,1	52,5	38,7	23,7				
KUBO V-L 159 M	2 x 1,1	2 x 1,5	45,0	42,8	40,5	39,2	37,9	35,0	31,8	28,4	24,8	22,8	20,8	16,3	
KUBO V-L 179 M	2 x 1,47	2 x 2	56,9	55,0	52,5	51,1	49,6	46,1	42,3	37,9	33,1	30,5	27,7	21,9	
KUBO V-L 209 M	2 x 1,85	2 x 2,5	68,1	66,2	63,4	61,6	59,7	55,1	49,6	43,2	36,0	33,0	29,7	23,1	
KUBO V-L 2012 M	2 x 1,47	2 x 2	47,8	46,4	44,8	43,9	43,0	41,0	38,8	36,5	33,9	32,6	31,2	28,3	25,2
KUBO V-L 2512 M	2 x 1,85	2 x 2,5	58,5	56,8	54,9	53,9	52,8	50,4	47,7	44,9	41,8	40,1	38,4	34,8	30,9
KUBO V-L 3012 M	2 x 2,2	2 x 3	69,5	67,7	65,5	64,3	63,1	60,2	57,1	53,6	49,8	47,8	45,7	41,2	36,4
Versione Trifase - Three phase Version 400V															
KUBO V-L 173 T	2 x 1,47	2 x 2	96,8	84,6	70,2	62,1	53,6	34,8							
KUBO V-L 176 T	2 x 1,47	2 x 2	81,0	75,0	68,1	64,3	60,2	51,4	41,7	31,0	19,4				
KUBO V-L 206 T	2 x 1,85	2 x 2,5	104,0	96,0	86,9	81,9	76,6	65,1	52,5	38,7	23,7				
KUBO V-L 179 T	2 x 1,47	2 x 2	56,9	55,0	52,5	51,1	49,6	46,1	42,3	37,9	33,1	30,5	27,7	21,9	
KUBO V-L 209 T	2 x 1,85	2 x 2,5	68,1	66,2	63,4	61,6	59,7	55,1	49,6	43,2	36,0	33,0	29,7	23,1	
KUBO V-L 2012 T	2 x 1,47	2 x 2	47,8	46,4	44,8	43,9	43,0	41,0	38,8	36,5	33,9	32,6	31,2	28,3	25,2
KUBO V-L 2512 T	2 x 1,85	2 x 2,5	58,5	56,8	54,9	53,9	52,8	50,4	47,7	44,9	41,8	40,1	38,4	34,8	30,9
KUBO V-L 3012 T	2 x 2,2	2 x 3	69,5	67,7	65,5	64,3	63,1	60,2	57,1	53,6	49,8	47,8	45,7	41,2	36,4

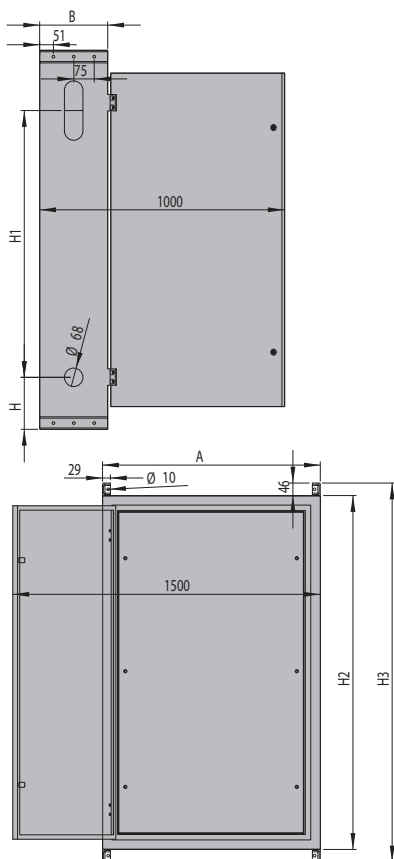

TIPO TYPE	DIMENSIONI [mm] DIMENSIONS [mm]								PESO WEIGHT [kg]
	H	H1	H2	H3	A	B	DNA	DNM	
KUBO V-L 123	150	1010	1300	1392	800	250	1" 1/2	1" 1/2	79
KUBO V-L 153		1055							83
KUBO V-L 173		1160							86
KUBO V-L 156		1010							82
KUBO V-L 176		1055							84
KUBO V-L 206		1160							90
KUBO V-L 159		1055							81
KUBO V-L 179		1080							82
KUBO V-L 209		1180							87
KUBO V-L 2012		1055							89
KUBO V-L 2512		1080							94
KUBO V-L 3012		1180							95

"KUBO INVENTApress"



GRUPPI DI PRESSURIZZAZIONE A VELOCITA' VARIABILE

"KUBO INVENTApress" è il sistema di pressurizzazione a velocità variabile più evoluto ad alta efficienza energetica, esso oltre ad utilizzare la tecnologia Inverter per modulare la velocità della pompa in modo da fornire la pressione costante al variare della portata richiesta, utilizza 2 pompe della serie Verti Line, che grazie al raffreddamento del motore tramite il liquido pompato, offrono una maggior efficienza rispetto alle pompe tradizionali.

Assemblati in un armadio compatto e pronti per essere installati all'interno o all'esterno, sono di dimensioni molto contenute, e grazie alla sua struttura rendono il sistema molto silenzioso e pratico da installare.

I gruppi di pressurizzazione automatici "KUBO INVENTApress" sono costituiti, oltre che dalle pompe, da:

- 2 Convertitori di frequenza tipo "INVENTA" con trasduttore di pressione collegato ai collettori
- Collettore di aspirazione in acciaio inox 304
- Valvola di ritegno, valvola sezionatrice in aspirazione a ciascuna pompa
- Collettore di mandata in acciaio zincato
- Un serbatoio da 8l. a membrana
- Valvola sezionatrice in mandata a ciascuna pompa
- Manometro

GROUPES DE PRESSURISATION À VITESSE VARIABLE

"KUBO INVENTApress" est le système de pressurisation à vitesse variable le plus évolué à haut rendement énergétique, il utilise en outre la technologie Inverter pour moduler la vitesse de la pompe de façon à fournir une pression constante quand le débit demandé varie, il utilise 2 pompes de la série Verti Line, qui grâce au refroidissement du moteur au moyen du liquide pompé, offrent une plus grande efficacité par rapport aux pompes traditionnelles.

Assemblés dans une armoire compacte et prêts pour être installés à l'intérieur ou à l'extérieur, ils sont de dimensions très réduites, et grâce à leur structure ils rendent le système très silencieux et pratique à installer.

Les groupes de pressurisation automatiques "KUBO INVENTApress" sont constitués, en dehors des pompes, de :

- 2 Convertisseurs de fréquence type "INVENTA" avec transducteur de pression raccordé aux collecteurs
- Collecteur d'aspiration en acier inox 304
- Clapet de non-retour, vanne de sectionnement en aspiration à chaque pompe
- Collecteur de refoulement en acier zingué
- Un réservoir de 8l. à membrane
- Vanne de sectionnement en refoulement à chaque pompe
- Manomètre

VARIABLE SPEED PRESSURE SYSTEMS

"KUBO INVENTApress" Is the most developed variable speed booster set with very high energy efficiency, the system in addition to the frequency converter type "INVENTA" based on INVERTER technology that permit the speed control of the pump so as keep the constant pressure to varying of the demanded flow, uses 2 pumps type Verti Line that thanks to the liquid cooling system of the motor, they offer a greater efficiency compared to the traditional pumps.

Assembled into a compact cabin ready to be assembled indoor or outdoor, having a very limited dimension and thanks to the particular structure render the system noiseless and easy to install.

The automatic pressure booster sets "KUBO INVENTApress" besides the pumps are consisting of:

- 2 frequency converter type "INVENTA" with pressure transducer already connected to the manifold
- Suction manifold
- Check valve, ball valve and suction to each pump
- Outlet manifold with connections for one 8 l. pressure tanks
- Outlet ball valve on each pump
- Pressure gauge

GRUPOS DE PRESURIZACIÓN A VELOCIDAD VARIABLE

"KUBO INVENTApress" es el sistema de presurización a velocidad variable con alta eficiencia energética más evolucionado que, además de utilizar la tecnología Inverter para modular la velocidad de la bomba en modo de proporcionar una presión constante no obstante los cambios del caudal requerido, emplea 2 bombas de la serie Verti Line que, gracias al enfriamiento del motor mediante el líquido bombeado, ofrecen una mayor eficiencia respecto a las bombas tradicionales.

Ensamblados en un armario compacto y listos para su instalación interior o exterior, tienen unas dimensiones muy reducidas, y gracias a su estructura hacen que el sistema sea muy silencioso y práctico para su instalación.

Los grupos de presurización automáticos "KUBO INVENTApress" están constituidos, además de por las bombas, por:

- 2 Convertidores de frecuencia tipo "INVENTA" con transductor de presión conectado a los colectores
- Colector de aspiración de acero inox 304
- Válvula de retención, válvula de corte en aspiración para cada bomba
- Colector de descarga de acero zincado
- Un depósito de 8l. con membrana
- Válvula de corte en descarga para cada bomba
- Manómetro

TIPO TYPE	Potenza nominale Nominal power	kW	HP	Prevalenza (m C.A.) Total head (m W.C.)														
				Q [m ³ /h]	0	2,4	4,8	6	7,2	9,6	12	14,4	16,8	18	19,2	21,6	24	
				Q [l/v']	0	40	80	100	120	160	200	240	280	300	320	360	400	
Versione Monofase - Single phase Version 230V																		
KUBO Inventapress V-L 123	2 x 0,88	2 x 1,2		54,3	48,1	40,1	35,5	30,4	19,0									
KUBO Inventapress V-L 153	2 x 1,1	2 x 1,5		73,4	63,3	52,0	45,9	39,6	26,0									
KUBO Inventapress V-L 156	2 x 1,1	2 x 1,5		58,1	54,3	49,7	47,0	44,1	37,7	30,4	22,3	13,3						
KUBO Inventapress V-L 176	2 x 1,47	2 x 2		81,0	75,0	68,1	64,3	60,2	51,4	41,7	31,0	19,4						
KUBO Inventapress V-L 159	2 x 1,1	2 x 1,5		45,0	42,8	40,5	39,2	37,9	35,0	31,8	28,4	24,8	22,8	20,8	16,3			
KUBO Inventapress V-L 179	2 x 1,47	2 x 2		56,9	55,0	52,5	51,1	49,6	46,1	42,3	37,9	33,1	30,5	27,7	21,9			
Versione Trifase - Three phase Version 400V																		
KUBO Inventapress V-L 173 T	2 x 1,47	2 x 2	H [m]	96,8	84,6	70,2	62,1	53,6	34,8									
KUBO Inventapress V-L 176 T	2 x 1,47	2 x 2		81,0	75,0	68,1	64,3	60,2	51,4	41,7	31,0	19,4						
KUBO Inventapress V-L 206 T	2 x 1,85	2 x 2,5		104,0	96,0	86,9	81,9	76,6	65,1	52,5	38,7	23,7						
KUBO Inventapress V-L 179 T	2 x 1,47	2 x 2		56,9	55,0	52,5	51,1	49,6	46,1	42,3	37,9	33,1	30,5	27,7	21,9			
KUBO Inventapress V-L 209 T	2 x 1,85	2 x 2,5		68,1	66,2	63,4	61,6	59,7	55,1	49,6	43,2	36,0	33,0	29,7	23,1			
KUBO Inventapress V-L 2012 T	2 x 1,47	2 x 2		47,8	46,4	44,8	43,9	43,0	41,0	38,8	36,5	33,9	32,6	31,2	28,3	25,2		
KUBO Inventapress V-L 2512 T	2 x 1,85	2 x 2,5		58,5	56,8	54,9	53,9	52,8	50,4	47,7	44,9	41,8	40,1	38,4	34,8	30,9		

L'acqua e un bene prezioso, utilizzala con cura

- Il sistema più facile da trasportare ed installare,
- Minimo ingombro,
- Possibilità d'installazione in ambienti estremi
- Velocità variabile
- Alta efficienza e bassi consumi elettrici
- Massima silenziosità

L'eau est un bien précieux, l'utiliser avec soin

- Le système le plus facile à transporter et à installer,
- Encombrement minimum
- Possibilité d'installation dans des milieux extrêmes
- Vitesse variable
- Efficacité élevée et faibles consommations électriques
- Silence maximum

Water it's precious, handle with care

- The most easy system to be carried and installed
- Compact design
- Suitable for extreme climate condition
- Variable speed
- High efficiency and low energy consumption
- Extreme noiseless

El agua es un bien precioso, utilízala con cuidado

- El sistema de más fácil transporte e instalación
- Ocupa el mínimo espacio
- Posibilidad de instalación en ambientes extremos
- Velocidad variable
- Alta eficiencia y bajo consumo eléctrico
- Muy silencioso

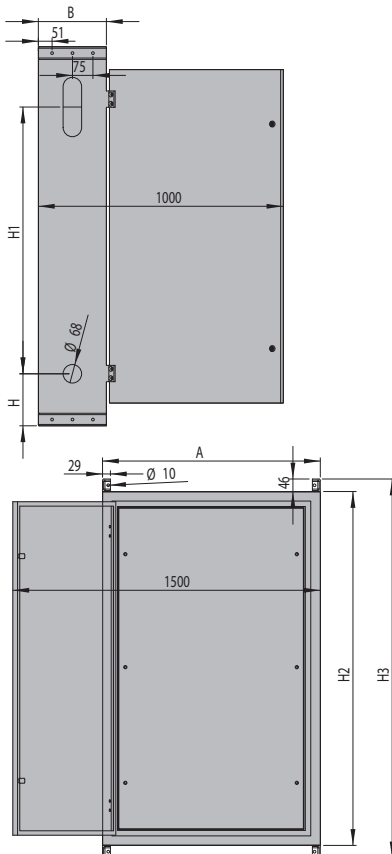

TIPO TYPE	DIMENSIONI [mm] DIMENSIONS [mm]								PESO WEIGHT [kg]
	H	H1	H2	H3	A	B	DNA	DNM	
KUBO Inventapress V-L 123		1010							86
KUBO Inventapress V-L 153		1055							90
KUBO Inventapress V-L 173		1160							93
KUBO Inventapress V-L 156		1010							89
KUBO Inventapress V-L 176		1055							91
KUBO Inventapress V-L 206	150	1160	1300	1392	800	250	1" 1/2	1" 1/2	97
KUBO Inventapress V-L 159		1055							88
KUBO Inventapress V-L 179		1080							89
KUBO Inventapress V-L 209		1180							94
KUBO Inventapress V-L 2012		1055							96
KUBO Inventapress V-L 2512		1080							101

"CKR"



ELETTROPOMPE DI CIRCOLAZIONE A ROTORE BAGNATO

Le elettropompe di circolazione a rotore bagnato con tre velocità della serie CKR sono state progettate per pompare liquidi caldi senza parti abrasive in sospensione, non esplosivi o aggressivi per i materiali della pompa (glicole max. 30%)

- Temperatura max. del liquido 110 °C e min. 5 °C e temperatura ambiente fino a 35 °C.

CARATTERISTICHE COSTRUTTIVE

- Corpo pompa: ghisa G20 con trattamento anticorrosione
- Camicia rotore e flangia motore: acciaio inox Aisi 303
- Cuscinetti: grafite
- Girante: Tecnopolimero
- Albero pompa: acciaio inox Aisi 420
- Motore asincrono a rotore bagnato, regolabile a 3 velocità, protezione IP 44, isolamento classe F.
- Alimentazione monofase con motoprotettore incorporato e condensatore permanentemente inserito .
- Alimentazione trifase con protezione obbligatoria a cura dell'utente.
- Servizio continuo.

CIRCULATING ELECTRIC PUMPS WITH WET ROTOR

The three speeds circulating electric pumps with of the series CKR have been designed to pump warm liquids without suspended abrasives, non-explosive or aggressive for the pumps' material (glycol max. 30%)

- Liquid temperature not higher than 110 °C and not lower than 5 °C, while the ambient temperature must not be higher than 35 °C.

TECHNICAL FEATURES

- Pump body: cast iron G20 with anti-corrosive coating
- Rotor sleeve and motor flange: stainless steel Aisi 303
- Bearings: graphite
- Impeller: Techno-polymer
- Pump shaft: stainless steel Aisi 420
- Asynchronous wet rotor motor, operating at 3 speeds protection IP 44, two poles, class F insulation.
- Single-phase feeding with incorporated motor protector and capacitor permanently connected.
- Three-phase feeding with compulsory protection to be provided by the user.
- Continuous duty.

ÉLECTROPOMPES DE CIRCULATION À ROTOR NOYÉ

Les électropompes de circulation à rotor noyé à trois vitesses de la série CKR ont été conçues pour pomper des liquides chauds sans parties abrasives en suspension, non explosifs ou agressifs pour les matériaux de la pompe (glycol max. 30%)

- Température max. du liquide 110 °C et min. 5 °C et température ambiante jusqu'à 35 °C.

CARACTERISTIQUES DE CONSTRUCTION

- Corps de pompe : En fonte G20 avec traitement anti-corrosion
- Chemise rotor et bride moteur: acier inox Aisi 303
- Roulements: graphite
- Turbine: Technopolymère
- Abre de pompe: acier inox Aisi 420
- Moteur asynchrone avec rotor noyé, 3 vitesse réglable, protection IP 44, classe d'isolation F.
- Alimentation monophasée avec haut-protecteur thermique et condensateur permanent.
- Alimentation triphasée avec protection requis par l'utilisateur.
- Le service continu.

ELECTROBOMBAS DE CIRCULACIÓN CON ROTOR HÚMEDO

Las electrobombas de circulación con rotor húmedo a tres velocidades de la serie CKR han sido proyectadas para bombear líquidos calientes sin partes abrasivas en suspensión, que no sean explosivos ni agresivos para los materiales de la bomba (glicol max. 30%)

- Temperatura max. del líquido 110 °C y min. 5 °C y temperatura ambiente hasta 35 °C.

CARACTERÍSTICAS DE CONSTRUCCIÓN

- Cuerpo de bomba: Fundición gris G20 con tratamiento contra-corrosión
- Camisa de rotor y tapa motor: de acero Inox AISI303
- Rodamientos: de grafito
- Rodete: De tecnopolímero
- Eje de la bomba: de acero Inox Aisi 420
- Motor asíncrono con rotor húmedo, 3 de velocidad ajustable, protección IP 44, aislamiento clase F.
- Fuente de alimentación monofásica con una función de protección térmica y condensador permanente.
- Alimentación trifásica, con protección requerido por el usuario.
- Servicio continuo.

TIPO TYPE		Potenza nominale Nominal power	Velocità Speed	n n	Condensatore Capacitor 450 V max	Corrente assorbita Input current			Portata - Capacity													
Monofase Single-phase	Trifase Three-phase					[A]			Q [m³/h]													
a	b	W	pos.	r.p.m	[µF]	1~ 230 V	3~ 230 V	3~ 400 V	0	1	2	3	4	6	8	10	12	14	16	18		
CKR 130/45		39	1	1315	2	0,17	-	-	0	17	33	50	67	100	133	167	200	233	267	300		
		60	2	1885		0,26	-	-	3,7	2,7	1,2											
		69	3	2456		0,3	-	-	4	3,5	2,6	1,4										
CKR 180/45		39	1	1315	2	0,17	-	-	3	1												
		60	2	1885		0,26	-	-	3,7	2,7	1,2											
		69	3	2456		0,3	-	-	4	3,5	2,6	1,4										
CKR 130/55		39	1	1080	2,5	0,17	-	-	3,6	1												
		62	2	1530		0,27	-	-	5	3	1,2											
		80	3	1980		0,38	-	-	5,5	4,4	3,2	1,7										
CKR 180/55		39	1	1080	2,5	0,17	-	-	3,6	1												
		62	2	1530		0,27	-	-	5	3	1,2											
		80	3	1980		0,38	-	-	5,5	4,4	3,2	1,7										
CKR 130/65		60	1	1080	3	0,19	-	-	3	1,1												
		78	2	1530		0,3	-	-	4,7	2,9	1,6											
		95	3	1980		0,44	-	-	6,6	5,5	3,9	2										
CKR 180/65		60	1	1080	3	0,19	-	-	3	1,1												
		78	2	1530		0,3	-	-	4,7	2,9	1,6											
		95	3	1980		0,44	-	-	6,6	5,5	3,9	2										
CKR 180/70		100	1	1109	3	0,39	-	-	4,1	2,2	0,4											
		120	2	1610		0,51	-	-	5,5	4,1	2,9	1,7	0,5									
		140	3	2340		0,62	-	-	6,8	6	5,2	4,3	3,1	2	0,4							
CKR 180/80		160	1	1150	4	0,46	-	-	5,5	2,5	1											
		185	2	1750		0,62	-	-	7	5,7	4,5	3,5	2,3	1								
		210	3	2450		0,91	-	-	7,8	7,7	7,5	5,7	4,9	4	1							
CKR 40/65 M	CKR 40/65 T	120	1	1440	6	1,15	0,44	0,26	3	2,5	2,2	1,9	1,6	1,2								
		230	2	2115		1,17	0,53	0,31	5,5	5	4,7	4,5	4,2	3,8	2,7	1,9						
		320	3	2790		1,19	0,61	0,36	6,7	6,2	6	5,8	5,5	5	3,7	3,3	2,5					
CKR 40/120 M	CKR 40/120 T	230	1	1250	10	1,85	0,44	0,26	4	3,5	2,9	2,4	2	1,5	1							
		420	2	2035		2,1	1,21	0,71	9	8,4	7,8	7,2	6,6	5,5	4,5	3,8	3	2				
		560	3	2820		2,35	1,97	1,16	11,5	11,2	11	10,6	10,2	9,3	8,4	7,3	6,3	5	4	2,5		

a) ~ Monofase 230 V

b) ~ Trifase 230/400 V

min⁻¹ ~ 2900

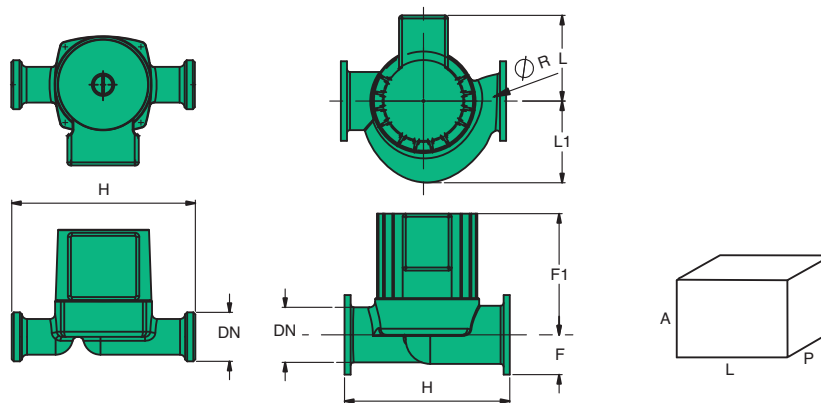
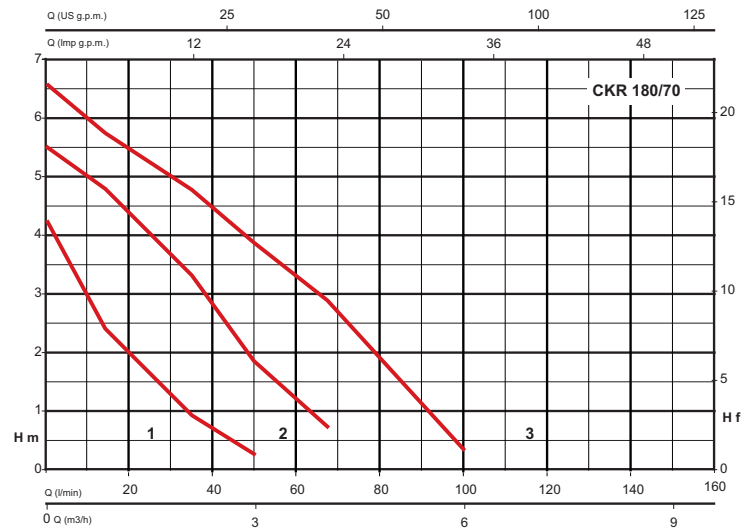
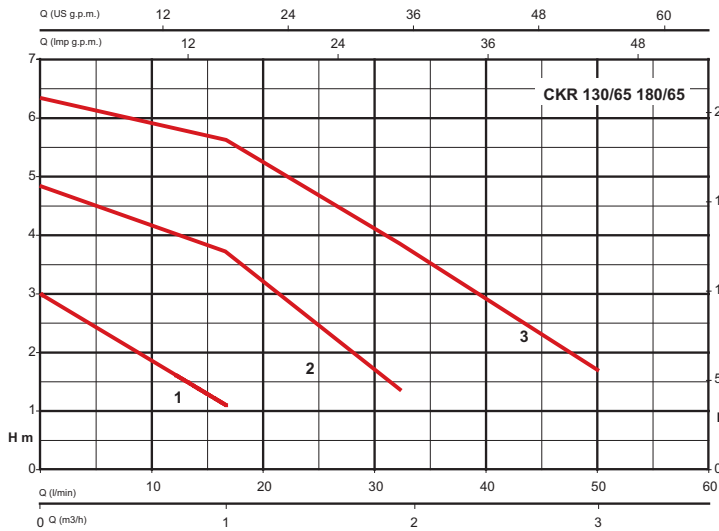
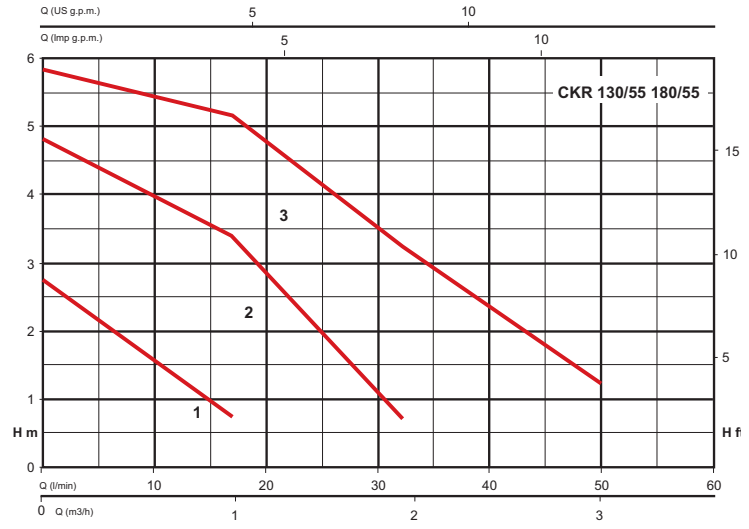
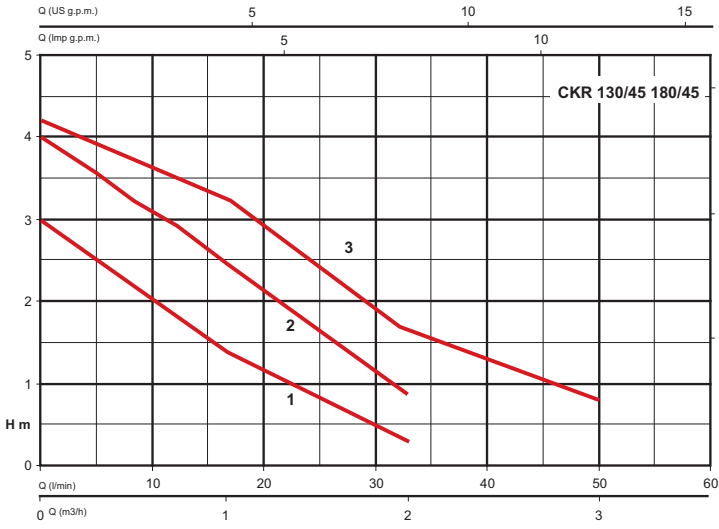

min⁻¹ ~ 2900

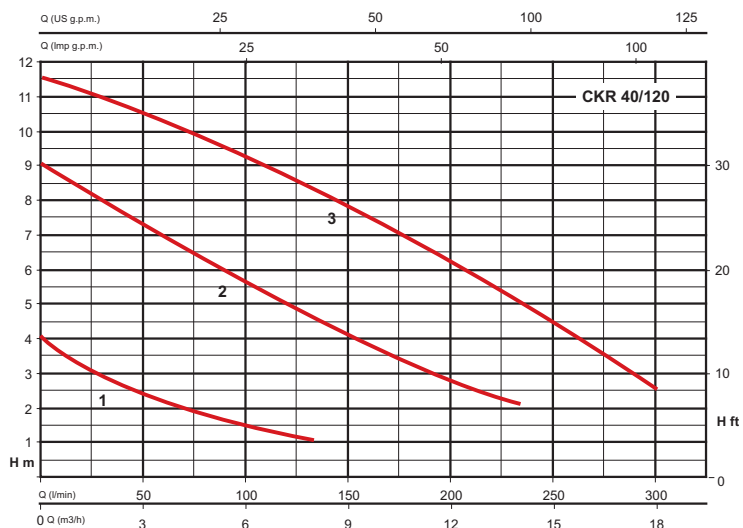
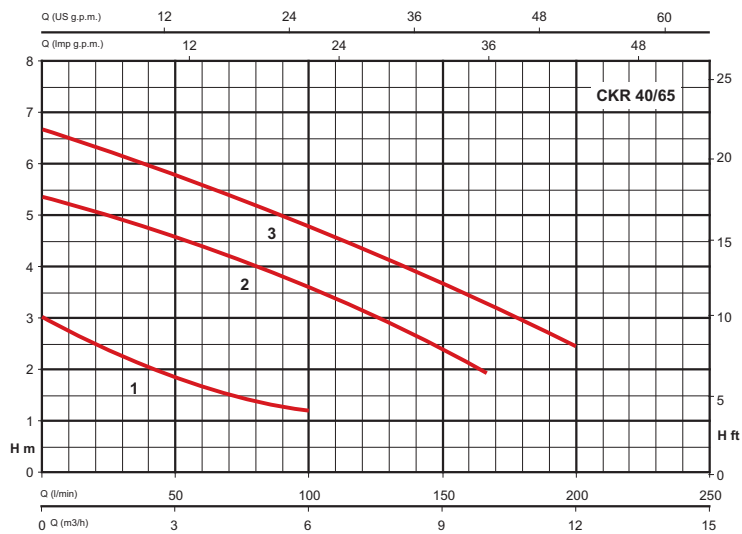
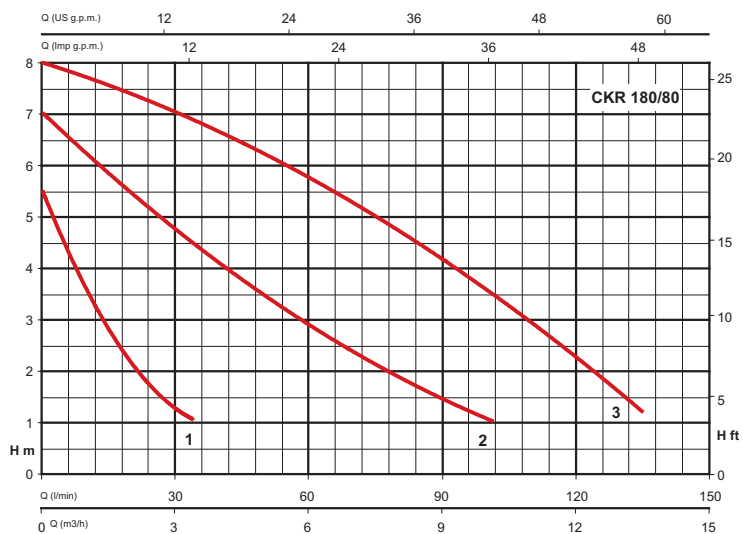

TIPO TYPE	DIMENSIONI [mm] DIMENSIONS [mm]								IMBALLO [mm] PACKING [mm]			PESO WEIGHT [kg]
	L	L1	H	DNA	DNM	F	F1	R	A	L	P	
CKR 130/45	-	-	130	1" 1/2	1" 1/2	-	-	-	150	135	200	2,4
CKR 180/45	-	-	180	1" 1/2	1" 1/2	-	-	-	150	135	200	2,6
CKR 130/55	-	-	130	1" 1/2	1" 1/2	-	-	-	150	135	200	2,4
CKR 180/55	-	-	180	1" 1/2	1" 1/2	-	-	-	150	135	200	2,6
CKR 130/65	-	-	130	1" 1/2	1" 1/2	-	-	-	150	135	200	2,4
CKR 180/65	-	-	180	1" 1/2	1" 1/2	-	-	-	150	135	200	2,6
CKR 180/70	-	-	180	1" 1/2	1" 1/2	-	-	-	150	135	200	3,2
CKR 180/80	-	-	180	2"	2"	-	-	-	150	135	200	4,8
CKR 40/65 M	153	92	250	40	40	65	198	1/4"	300	280	280	18
CKR 40/65 T	153	92	250	40	40	65	198	1/4"	300	280	280	18
CKR 40/120 M	153	92	250	40	40	65	198	1/4"	300	280	280	18
CKR 40/120 T	153	92	250	40	40	65	198	1/4"	300	280	280	18

"QUICK"

■ POMPE PER TRAVASO GASOLIO

IMPIEGHI

Le elettropompe della serie "QUICK" sono state progettate per travasare gasolio da fusti, cisterne o altri contenitori. Indispensabile presso fattorie, industrie, imprese di costruzioni o trasporti e abitazioni private, per riempire i serbatoi delle macchine agricole, camion o bus, macchine da giardinaggio o altri mezzi alimentati a gasolio. Possono inoltre essere utilizzate per alimentare gli impianti di riscaldamento a gasolio.

Attenzione: è vietato l'uso delle elettropompe della serie "QUICK" per benzina, acidi o liquidi esplosivi.



CARATTERISTICHE COSTRUTTIVE

QUICK MINI: Elettropompa autoadescente con girante a palette tipo volumetrico con by-pass incorporato. Fornita di 4m. di tubo raccordato, filtro aspirazione, pistola da travaso in plastica, interruttore, 1 m di cavo con clips per collegamento ad alimentatori



QUICK MIDI: Elettropompa monoblocco con girante tipo periferica. Fornita di 4 m di tubo raccordato, valvola di fondo in ottone, pistola da travaso in plastica, interruttore, 1 m di cavo con spina.

QUICK MAXI: Elettropompa centrifuga autoadescente ad anello liquido. Fornita di 4 m di tubo raccordato, valvola di fondo in ottone, pistola da travaso in plastica, interruttore, 1 m di cavo con spina.

QUICK STATION

Stazione per travaso gasolio completa di elettropompa autoadescente tipo "QUICK MAXI", 2 + 4 m di tubo raccordato, valvola di fondo in ottone, pistola da travaso automatica, contalitri, interruttore, 1 m di cavo con spina.



■ ELECTRIC PUMPS FOR DIESEL OIL

APPLICATIONS

The electric pumps series Quick have been designed for diesel oil decanting from drums, casks, tanks and from other containers. They are the basic instruments in farms, industries, transport and building companies, private houses, for filling tanks of agricultural machineries, gardening machineries and other means equipped with diesel motors. They can also be utilized for filling diesel oil heating systems.

Attention: the electric pumps series "QUICK" must not be use with petrol, acids and other explosive liquids.

TECHNICAL FEATURES

QUICK MINI: Self-priming paddle electric pump, volumetric type, with incorporated by-pass. Equipped with 4m. connected hose, suction filter, plastic gun, switch, 1 m cable with clips connecting feeders.

QUICK MIDI: Closed-coupled electrical pump with peripheral impeller, equipped with 4 m connected hose, brass foot valve, plastic gun, switch, 1 m cable with plug.

QUICK MAXI: Liquid ring self-priming centrifugal electric pump equipped with 4 m connected hose, brass foot valve, plastic gun, switch and 1 m cable with plug.

QUICK STATION

Diesel oil station equipped with self-priming electrical pump type "QUICK MAXI", 2 +4 m connected hose, brass foot valve, automatic gun, flow meter, switch, 1 m cable with plug.



POMPES POUR TRANSVASEMENT GASOIL

EMPLOIS

Les électropompes de la série "QUICK" ont été conçues pour transvaser du gasoil de bidons, citernes ou autres récipients. Indispensable dans les usines, les industries, les entreprises de construction ou de transport et les habitations privées, pour remplir les réservoirs des machines agricoles, les camions ou les bus, les engins de jardinage ou autres engins alimentés au gasoil. Elles peuvent de plus être utilisées pour alimenter les équipements de chauffage au fuel.

Attention : il est interdit d'utiliser les électropompes de la série "QUICK" pour l'essence, des acides ou des liquides explosifs.

CARACTÉRISTIQUES DE CONSTRUCTION

QUICK MINI: Électropompe autoamorçante avec roue à aubes type volumétrique avec by-pass incorporé. Fournie avec 4m. de tuyau raccordé, filtre aspiration, pistolet de transvasement en plastique, interrupteur, 1 m de fil avec clips pour raccordement à des alimentateurs

QUICK MIDI: Électropompe monobloc avec roue type périphérique. Fournie avec 4m. de tuyau raccordé, valve d'arrêt en laiton, pistolet de transvasement en plastique, interrupteur, 1 m de fil avec fiche.

QUICK MAXI: Électropompe centrifuge autoamorçante à anneau liquide. Fournie avec 4m. de tuyau raccordé, valve d'arrêt en laiton, pistolet de transvasement en plastique, interrupteur, 1 m de fil avec fiche.

QUICK STATION

Station pour transvasement de gasoil munie d'une électropompe autoamorçante type "QUICK MAXI", 2 + 4 m de tuyau raccordé, valve d'arrêt en laiton, pistolet de transvasement automatique, compte-litres, interrupteur, 1 m de fil avec fiche.

BOMBAS DE TRASVASE DE GASÓLEO

APLICACIONES

Las electrobombas de la serie "QUICK" han sido proyectadas para trasvasar gasoleo desde barriles, cisternas u otros contenedores. Indispensable en granjas, industrias, empresas de construcción o de transportes y casas particulares, para llenar los depósitos de la maquinaria agrícola, camiones o autobuses, máquinas de jardinería u otros medios alimentados a gasóleo. Pueden también ser utilizados para alimentar las instalaciones de calefacción a gasóleo. **Atención: está prohibido el uso de las electrobombas de la serie "QUICK" con gasolina, ácidos o líquidos explosivos.**

CARACTERÍSTICAS DE CONSTRUCCIÓN

QUICK MINI: Electrobomba autocebada con impulsor de paletas de tipo volumétrico con tubo de derivación incorporado. Dotada de 4m. de manguera empalmada, filtro de aspiración, pistola de trasvase de plástico, interruptor, 1 m di cable con clips para conectarse a los alimentadores

QUICK MIDI: Electrobomba monobloque con impulsor de tipo periférica. Dotada de 4 m de manguera empalmada, válvula de fondo de latón, pistola de trasvase de plástico, interruptor, 1 m de cable con enchufe.

QUICK MAXI: Electrobomba centrifuga autocebada de anillo líquido. Dotada de 4 m de manguera empalmada, válvula de fondo de latón, pistola de trasvase de plástico, interruptor, 1 m de cable con enchufe.

QUICK STATION

Estación para trasvase de gasóleo provista de electrobomba autocebada tipo "QUICK MAXI", 2 + 4 m de manguera empalmada, válvula di fondo de latón, pistola de trasvase automática, cuentalitros, interruptor, 1 m de cable con enchufe.

TIPO TYPE	Tensione nominale Rated voltage [V]	Potenza assorbita Input power [W]	Corrente assorbita Input current [A]	Portata max Max capacity [L/1']	Prevalenza max Max. head [m]	DN	Peso Weight [Kg]	Quantità per pallet Quantity per pallet
QUICK MINI 12	12	140	11.8	40	12	1" X 1"	5	77
QUICK MINI 24	24	140	5.8	40	12	1" X 1"	5	77

TIPO TYPE	Frequenza Frequency [Hz]	Potenza nominale Nominal power		Potenza assorbita Input power [W]	Condensatore Capacitor 450 V max [µF]	Corrente assorbita Input current [A] 1~ 230 V	Portata max Max. capacity [L/1']	Prevalenza max Max. head [m]	DN	Peso Weight [Kg]	Quantità per pallet Quantity per pallet
		kW	HP								
QUICK MIDI	50	0,37	0,5	435	10	2,7	36	37	1" X 1"	7,9	77

TIPO TYPE	Frequenza Frequency [Hz]	Potenza nominale Nominal power		Potenza assorbita Input power [W]	Condensatore Capacitor 450 V max [µF]	Corrente assorbita Input current [A] 1~ 230 V	Portata max Max. capacity [L/1']	Prevalenza max Max. head [m]	DN	Peso Weight [Kg]	Quantità per pallet Quantity per pallet
		kW	HP								
QUICK MAXI	50	0,59	0,8	800	14	3,9	40	40	1" X 1"	12,3	77

"SKUBA"



NOMENCLATURA PARTI DI RICAMBIO
SPARE PARTS LIST
NOMENCLATURE PIECES DE RECHANGE
NOMENCLATURA REPUESTOS

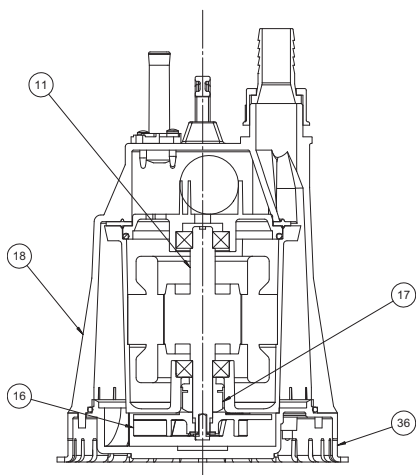

- 11** Albero con rotore – Pump shaft + rotor
Arbre + rotor – Eje rotor
- 16** Girante – Impeller
Turbine – Impulsor
- 17** Tenuta meccanica – Mechanical seal
Garniture mécanique – Cierre mecánico
- 18** Corpo pompa – Pump body
Corp de pompe – Cuerpo bomba
- 36** Base filtro – Filter base
Base filtre – Filtro básico

ELETTROPOMPE SOMMERGIBILI PER DRENAGGIO

Elettropompe sommergibili a girante aperta della serie SKUBA sono state progettate per pompare liquidi puliti o parzialmente sporchi, senza parti abrasive o corpi solidi in sospensione, non esplosivi o aggressivi per i materiali della pompa. Temperatura max. del liquido fino a 35 °C. (CEI EN 60335-2-41). Le pompe possono lavorare anche parzialmente sommerse.

CARATTERISTICHE COSTRUTTIVE

- Corpo pompa, girante, testata, manico di trasporto e base filtro: Tecnopolimero
- Corpo motore: in alluminio pressofuso UNI 5076
- Albero pompa e viti: in acciaio inox Aisi 420 F
- Tenuta meccanica in carbone-ceramica
- 5 m cavo alimentazione tipo H05RN-F
- Immersione max. 5 m

MOTORE

- Motore ad induzione a due poli, riavvolgibile, refrigerato dal liquido pompato, con protezione IP68, isolamento classe F.
- Alimentazione monofase con motoprotettore incorporato e condensatore permanentemente inserito.
- Servizio continuo se completamente sommersa.

A RICHIESTA:

- Versione automatica con galleggiante flottante (SKUBA Aut.).

SUBMERSIBLE DRAINING ELECTRIC PUMPS

The submersible electric pumps with open impeller series SKUBA have been designed to pump clear or slightly dirty liquids, without abrasives and suspended solids, non-explosive or aggressive for the pump's materials. Liquid temperature not higher than 35 °C (CEI EN 60335-2-41). The pumps may work also partially immersed.

TECHNICAL FEATURES

- Pump body, impeller, outer motor casing, filter base and handle: Technopolymer
- Motor body: in die casting aluminium UNI 5076
- Pump shaft and screws: in stainless steel Aisi 420 F
- Mechanical seal in carbon-ceramics
- 5 m H05RN-F feeding cable
- Max. immersion 5 m

MOTOR

- Two poles induction rewindable motor, cooled by the pumped liquid, with protection IP 68, class F insulation.
- Single-phase feeding with incorporated motor protector and capacitor permanently connected.
- Continuous duty if completely submerged.

ON REQUEST:

- Automatic version with float switch (SKUBA Aut.).

ÉLECTROPOMPES SUBMERSIBLES POUR DRAINAGE

Les électropompes submersibles à roue ouverte de la série SKUBA ont été conçues pour pomper des liquides propres ou partiellement sales, sans parties abrasives ou corps solides en suspension, non explosifs ou agressifs pour les matériaux de la pompe. Température max. du liquide jusqu'à 35 °C. (CEI EN 60335-2-41). Les pompes peuvent fonctionner même partiellement immergées.

CARACTERISTIQUES DE CONSTRUCTION

- Corps de pompe, Turbine, couvercle avec la poignée et filtre: Tecnopolimère
- Corps de moteur: aluminium moulé sur pression UNI 5076
- Abre de pompe et vis en acier inox Aisi 420 F
- Garniture mécanique en Carbone dur - Céramique
- 5 m Câble d'alimentation H07RN-F.
- Immergée max. 5 mt

MOTOR

- Moteur à induction à deux pôles rebobinable, refroidi par le liquide pompé, protection IP68, classe d'isolation F.
- Le modèles monophasé son avec protection thermique et condensateur connecté en permanence
- Service S1

SUR DEMANDE:

- Version avec flotteur automatique (SKUBA Aut.).

ELECTROBOMBAS SUMERGIBLES DE DRENAJE

Electrobombas sumergibles a impulsor con impulsor abierto de la serie SKUBA han sido proyectadas para bombear líquidos limpios o parcialmente sucios, sin partes abrasivas o cuerpos sólidos en suspensión, que no sean explosivos ni agresivos para los materiales de la bomba. Temperatura max. del líquido hasta 35 °C. (CEI EN 60335-2-41). Las bombas pueden funcionar incluso sumergidas parcialmente.

CARACTERISTICAS DE CONSTRUCCIÓN

- Cuerpo de bomba, Rodete, filtro y tapa con el mango: De tecnopolímero
- Cuerpo de motor: fundición de aluminio UNI 5076
- Eje de la bomba y tornillo: de acero Inox Aisi 420 F
- Cierre mecánico: De cerámica y grafito
- Cable de alimentación: 5 mt H07RN-F
- Máxima inmersión: 5 mt

MOTOR

- Motor a induction de dos poles rebobinables, enfriado por el líquido bombeado, protección IP68, aislamiento de clase F.
- Para los modelos monofásicos, protección térmica y condensador incorporado
- Funcionamiento S1

BAJO DEMANDA:

- Versión con interruptor de nivel automático (SKUBA Aut.)

50 Hz

TIPO TYPE Monofase Single-phase	Potenza nominale Nominal power		Potenza assorbita Input power [W]	Conden- satore Capacitor 450 V max [µF]	Corrente assorbita Input current [A] 1~ 230 V	Portata - Capacity										
						Q [m ³ /h]	0	0.6	1.2	1.8	2.4	3	3.6	4.2	4.8	5.4
						Q [l/s]	0	10	20	30	40	50	60	70	80	90
						Prevalenza (m C.A.) Total head (m W.C.)										
SKUBA 35 EVO	0,26	0,35	240	6.3	1	H [m]	6.0	5.3	4.7	4.1	3.6	3.1	2.6	2.2	1.8	1.5

a) ~ Monofase 230 V

60 Hz

TIPO TYPE Monofase Single-phase	Potenza nominale Nominal power		Potenza assorbita Input power [W]	Conden- satore Capacitor 450 V max [µF]	Corrente assorbita Input current [A] 1~ 220 V	Portata - Capacity										
						Q [m ³ /h]	0	0.6	1.2	1.8	2.4	3	3.6	4.2	4.8	5.4
						Q [l/s]	0	10	20	30	40	50	60	70	80	90
						Prevalenza (m C.A.) Total head (m W.C.)										
SKUBA 35 EVO	0,26	0,35	320	4	1,52	H [m]	9,5	8,6	7,5	6,4	5,2	4	2,6	1,2		

a) ~ Monofase 220 V

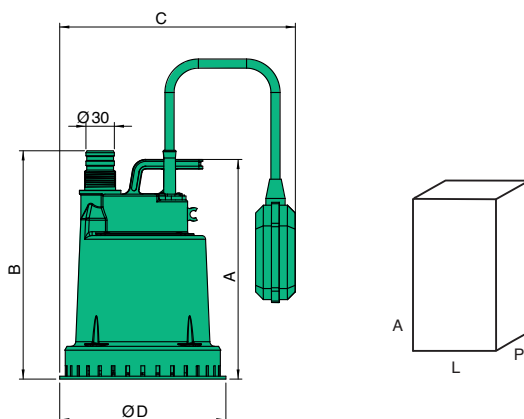

TIPO TYPE	DIMENSIONI [mm] DIMENSIONS [mm]					IMBALLO [mm] PACKING [mm]			PESO WEIGHT [kg]
	A	B	C	D	DNM	A	L	P	
SKUBA 35	240	220	275	163	1"	300	250	180	3,8

$\text{min}^{-1} \sim 2900$

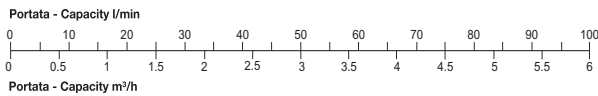
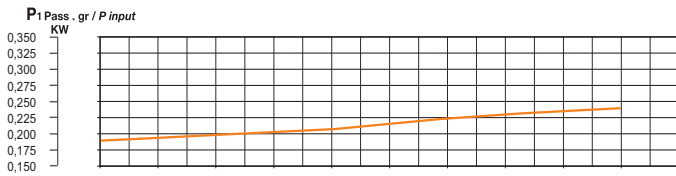
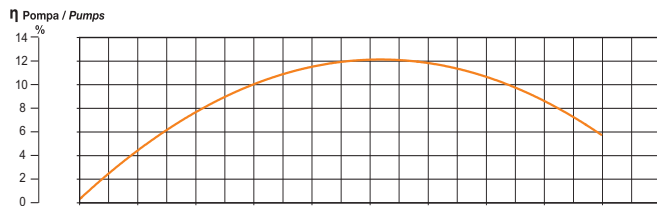
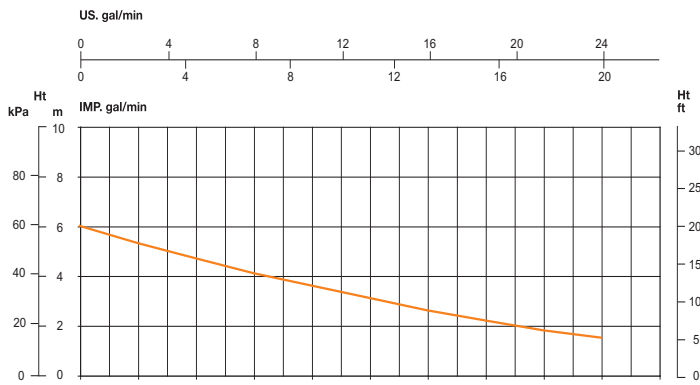

$\text{min}^{-1} \sim 3400$

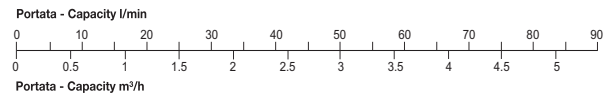
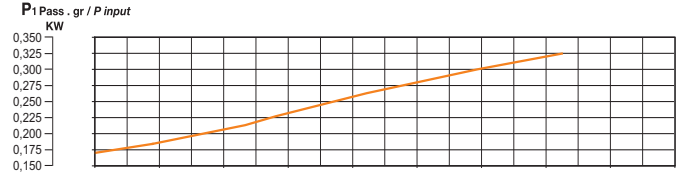
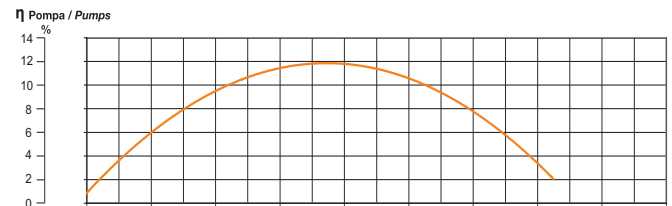
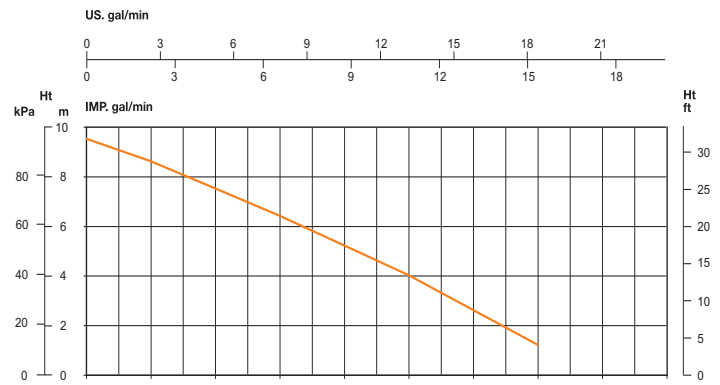

"Venezia"



300-500



Innovativa nel design e nei materiali brevetto internazionale
Innovation design and material international Patent
Innovante dans le design et dans les matériaux brevet international
Innovadora tanto en diseño como en los materiales, patente internacional

NOMENCLATURA PARTI DI RICAMBIO
SPARE PARTS LIST
NOMENCLATURE PIECES DE RECHANGE
NOMENCLATURA REPUESTOS

Valvola di non ritorno integrata
Galleggiante integrato
Prestazioni eccezionali

Built in non return valve
Built in float switch
Exceptional performance

Clapet de non-retour intégré
Flotteur intégré
Performances exceptionnelles

Válvula anti-retorno integrada
Flotador integrado
Prestaciones excepcionales

Connettore estraibile a tenuta stagna con innesto rapido
Quick cable coupling watertight connector
Connecteur extractible étanche avec accrochage rapide
Conector extraíble estanco de acoplamiento rápido

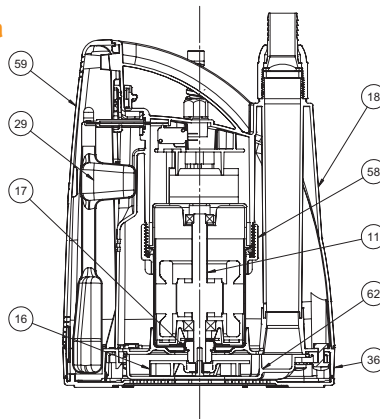

- 11** Albero con rotore – Pump shaft + rotor
Arbre + rotor – Eje rotor
- 16** Girante – Impeller
Turbine – Impulsor
- 17** Tenuta meccanica – Mechanical seal
Garniture mécanique – Cierre mecánico
- 18** Corpo pompa – Pump body
Corp de pompe – Cuerpo bomba
- 29** Galleggiante – Float switch
Flotteur – Flotador
- 36** Base filtro – Filter base
Base filtre – Filtro básico
- 58** Ghiera fissaggio motore – Motor fixing ring nut
Bague fixation moteur – Virola de fijación del motor
- 59** Copri galleggiante – Float switch cover
Couvres flottant – Tapa flotador
- 62** Voluta – Internal diffuser
Diffuseur interne – Difusor interior

ELETTROPOMPE SOMMERGIBILI PER DRENAGGIO

Le elettropompe sommergibili girante aperta della linea VENEZIA® sono state realizzate utilizzando i più moderni e sofisticati sistemi di progettazione d'ingegneria e design industriale. La particolare forma, l'interruttore di funzionamento automatico integrato, la possibilità di lavorare anche parzialmente immersa, la totale assenza di viti, i particolari polimeri composti utilizzati, rendono le Venezia® una delle pompe più innovative e tecnologicamente avanzate presenti sul mercato.

Le VENEZIA® sono state progettate per il pompaggio di acque pulite, reflue, non aggressive per i materiali della pompa. Temperatura max. del liquido fino a 35 °C (CEI EN 60335-2-41).

Le VENEZIA® possono lavorare anche parzialmente sommerse.

Le VENEZIA® 300 e 500 possono aspirare acqua fino a 2 mm.

CARATTERISTICHE COSTRUTTIVE

- Corpo pompa, testata e base filtro: Syntegum 1720
- Girante: in Dynaril
- Supporto cuscinetti: in alluminio pressofuso UNI 5076
- Corpo motore: in acciaio inox Aisi 304
- Albero pompa: in acciaio inox Aisi 420 F
- Tenuta meccanica lato pompa: carbone ceramica
- Tenuta lato motore: a labbro in NBR
- 10 m cavo alimentazione tipo H05RN-F
- Immersione max. 5 m

MOTORE

- Motore ad induzione a due poli, riavvolgibile, refrigerato dal liquido pompato, con protezione IP68, isolamento classe F.
- Alimentazione monofase con motoprotettore incorporato e condensatore permanentemente inserito.
- Servizio continuo.

ÉLECTROPOMPES SUBMERSIBLES POUR DRAINAGE

Les électropompes submersibles à roue ouverte de la ligne VENEZIA® ont été réalisées en utilisant les plus modernes et les plus sophistiqués systèmes de projet d'ingénierie et de design industriel. La forme particulière, l'interrupteur de fonctionnement automatique intégré, la possibilité de fonctionner même partiellement immergée, la totale absence de vis, les polymères composites particuliers utilisés, rendent les Venezia® une des pompes les plus innovantes et technologiquement avancées présentes sur le marché.

Les VENEZIA® ont été conçues pour le pompage d'eaux propres, usées, non agressives pour les matériaux de la pompe. Température max. du liquide jusqu'à 35 °C (CEI EN 60335-2-41).

Les VENEZIA® peuvent fonctionner même partiellement immergées.

Les VENEZIA® 300 et 500 peuvent aspirer de l'eau jusqu'à 2 mm.

CARACTERISTIQUES DE CONSTRUCTION

- Corps de pompe, bouchon et base filtre: Syntegum 1720
- Turbine: Dynaril
- Support roulements : aluminium moulé sur pression UNI 5076
- Corps de moteur: en acier inox Aisi 304
- Abre de pompe: en acier inox Aisi 420 F
- Garniture mécanique partie pompe: Carbone dur - Céramique
- Garniture partie moteur: à lèvres en élastomère 10 m
- Câble d'alimentation H05RN-F
- Immergée max. 5 mt

MOTOR

- Moteur à induction à deux pôles rebobinable, refroidi par le liquide pompé, protection IP68, classe d'isolation F.
- Le modèles monophasé son avec protection thermique et condensateur connecté en permanence
- Service S1

SUBMERSIBLE DRAINING ELECTRIC PUMPS

The submersible draining pumps with open impeller of the series VENEZIA® have been developed with the most advanced and sophisticated engineering and industrial design systems. The particular form, the integrated automatic switch, the possibility to operate also if partially submerged, the total absence of screws and the particular compound polymers used, make Venezia® one of the most innovative and technological advanced pumps available or the market.

The VENEZIA® have been design to pump clear water, waste water or slightly dirty water, but not aggressive for the pump's materials. Liquid temperature not higher than 35 °C (CEI EN 60335-2-41).

The VENEZIA® may work also partially immersed.

The VENEZIA® version 300 & 500 may suck water up to 2 mm.

TECHNICAL FEATURES

- Pump body, outer motor casing and base filter: Syntegum 1720
- Impeller: in Dynaril
- Bearings bracket: in die casting aluminium UNI 5076
- Motor body in stainless steel: Aisi 304
- Pump shaft: stainless steel: Aisi 420 F
- Pump's side mechanical seal: carbon-ceramics
- Motor's side seal: lip ring in NBR
- 10 m H05RN-F feeding cable
- Max. immersion 5 m

MOTOR

- Two poles induction rewindable motor, cooled by the pumped liquid, with protection IP 68, class F insulation.
- Single-phase feeding with incorporated motor protector and capacitor permanently connected.
- Continuous duty.

ELECTROBOMBAS SUMERGIBLES PARA DRENAJE

Las electrobombas sumergibles con impulsor abierto de la línea VENEZIA® han sido realizadas utilizando los más modernos y sofisticados sistemas de proyectación de ingeniería y de diseño industrial. La particularidad de su forma, el interruptor de funcionamiento automático integrado, la posibilidad de trabajar incluso parcialmente inmersa, la total ausencia de tornillos, los especiales polímeros compuestos utilizados, hacen de Venezia® una de las bombas más innovadoras y tecnológicamente avanzadas presentes en el mercado.

Las bombas VENEZIA® han sido proyectadas para el bombeo de aguas limpias, residuales, no agresivas para los materiales de la bomba. Temperatura max. del líquido hasta 35 °C (CEI EN 60335-2-41).

Las bombas VENEZIA® pueden trabajar incluso parcialmente sumergidas.

Las VENEZIA® 300 y 500 pueden aspirar agua hasta 2 mm.

CARACTERISTICAS DE CONSTRUCCIÓN

- Cuerpo de bomba, filtro y tapa con el mango: Syntegum 1720
- Rodete: Dynaril
- Soporte portarrodamientos: fundición de aluminio UNI 5076
- Cuerpo de motor: de acero Inox AISI304
- Eje de la bomba: de acero Inox Aisi 420 F
- Cierre mecánico lado bombas: De cerámica y grafito
- Cierre lado motor: anillo de cierre en NBR
- Cable de alimentación :10 mt H07RN-F
- Máxima inmersión :5 mt

MOTOR

- Motor a induction de dos poles rebobinables, enfriado por el líquido bombeado, protección IP68, aislamiento de clase F.
- Para los modelos monofásicos, protección térmica y condensador incorporado
- Funcionamiento S1

50 Hz

TIPO TYPE Monofase Single-phase	Potenza nominale Nominal power		Potenza assorbita Input power [W]	Condensatore Capacitor 450 V max [μF]	Corrente assorbita Input current [A] 1~ 230 V	Portata - Capacity											
	kW	HP				Prevalenza (m C.A.) Total head (m W.C.)											
			a	Q [m³/h] Q [l/s]													
Venezia 300	0,26	0,35	310	6,3	1,4	0	3	4,2	5,4	6	7,2	8,4	9,6	10,8	12	14,4	16,8
Venezia 500	0,37	0,5	430	8	2	0	50	70	90	100	120	140	160	180	200	240	280
Venezia 700	0,51	0,7	580	12,5	2,5	H [m]											
Venezia 900	0,59	0,8	720	14	3,2	6,4	4,6	3,7	2,7	2,1							
						8,5	6,7	5,9	4,9	4,4	3,4	2,3					
						10,9	9,3	8,5	7,7	7,2	6,3	5,4	4,3	3,2	2,1		
						12,4	10,4	9,6	8,8	8,3	7,5	6,6	5,7	4,8	3,9	2,1	1,2

a) ~ Monofase 230 V

60 Hz

TIPO TYPE Monofase Single-phase	Potenza nominale Nominal power		Potenza assorbita Input power [W]	Condensatore Capacitor 450 V max [μF]	Corrente assorbita Input current [A] 1~ 220 V	Portata - Capacity											
	kW	HP				Prevalenza (m C.A.) Total head (m W.C.)											
			a	Q [m³/h] Q [l/s]													
Venezia 300	0,26	0,35	350	6,3	1,6	0	3	4,2	5,4	6	7,2	8,4	9,6	10,8	12	14,4	16,8
Venezia 500	0,37	0,5	410	10	1,9	0	50	70	90	100	120	140	160	180	200	240	280
Venezia 700	0,51	0,7	600	12,5	2,6	H [m]											
Venezia 900	0,59	0,8	830	14	3,8	6,7	6,1	5,8	5,1	4,3	3,4	2,9					
						7,7	6,9	6,5	5,7	4,8	4,0	3,5	2,6	1,6			
						9,8	8,2	7,4	6,6	6,2	5,3	4,3	3,4	2,3	1,2		
						12,0	10,9	10,4	9,7	9,1	8,3	7,6	6,8	5,9	5,1	3,2	1,1

a) ~ Monofase 220 V

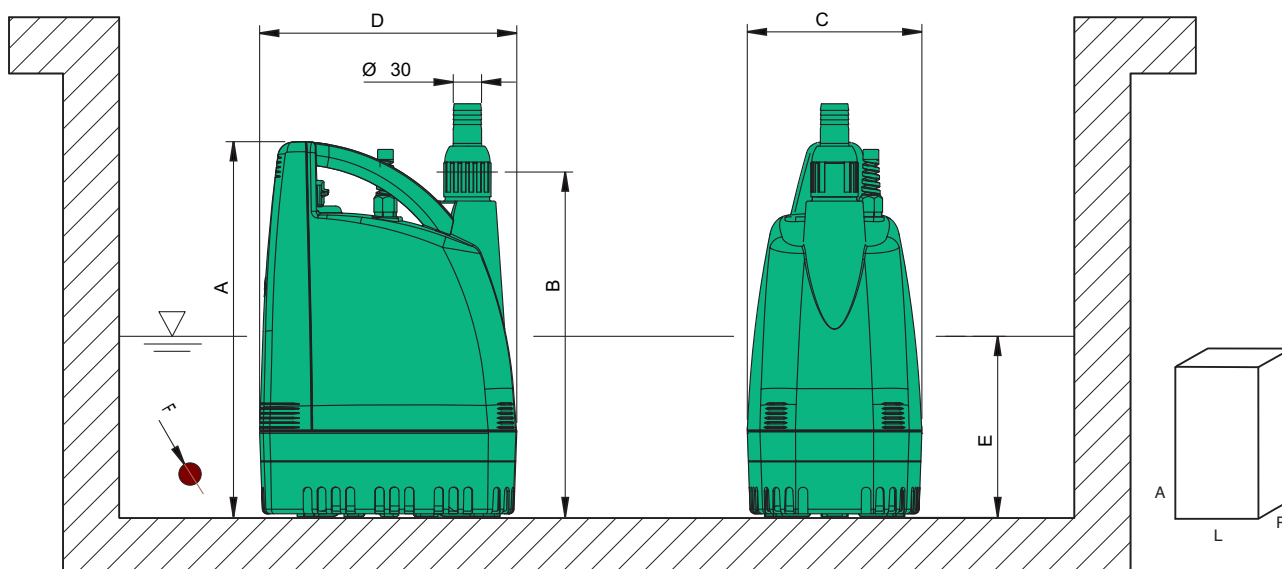

TIPO TYPE	DIMENSIONI [mm] DIMENSIONS [mm]							IMBALLO [mm] PACKING [mm]			PESO WEIGHT [kg]
	A	B	C	D	E	F	DNM	A	L	P	
Venezia 300	355	325	175	270	120	∅ 2	1"1/4	430	280	230	5,3
Venezia 500	355	325	175	270	120	∅ 2	1"1/4	430	280	230	5,7
Venezia 700	400	365	175	270	120	∅ 9	1"1/4	430	280	230	6,6
Venezia 900	400	365	175	270	120	∅ 9	1"1/4	430	280	230	7,6

min⁻¹ ~ 2900

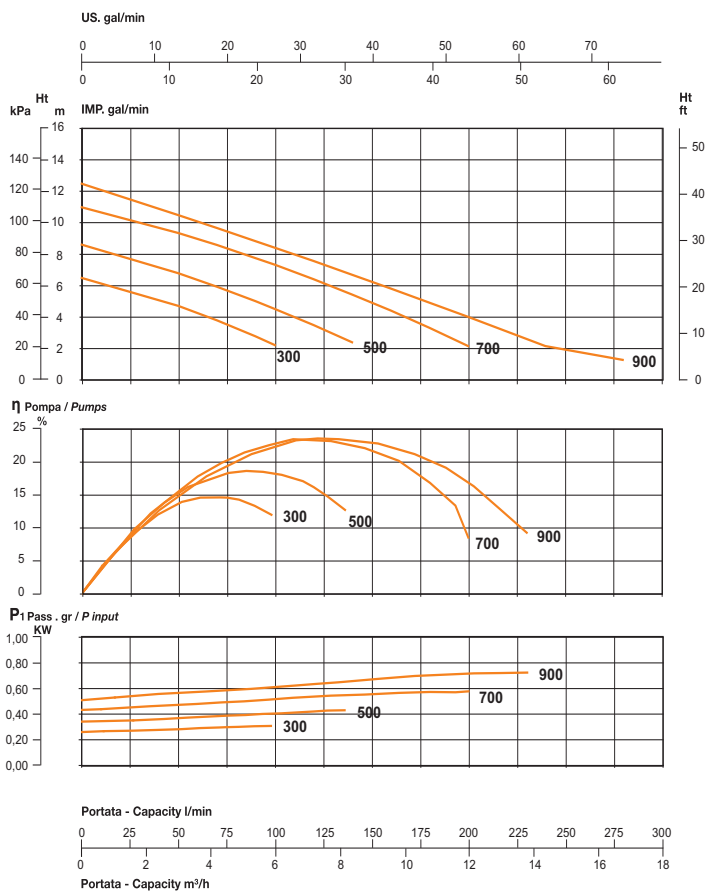

min⁻¹ ~ 3400

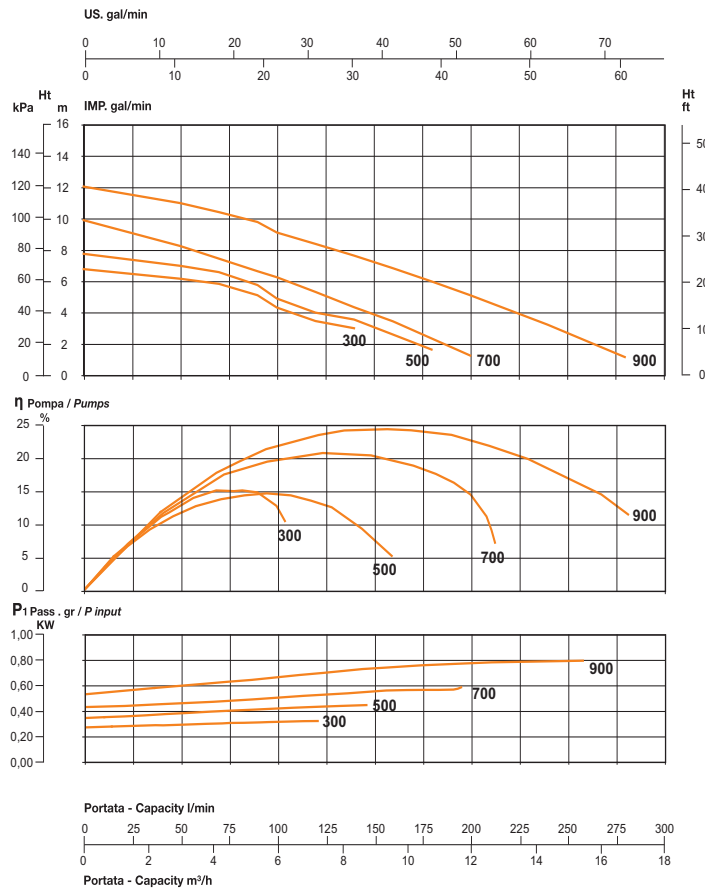

"Venezia® Vortex"

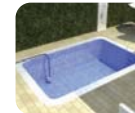
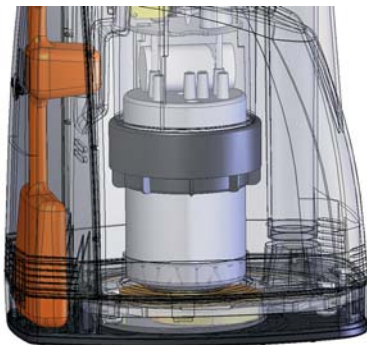

Innovativa nel design e nei materiali brevetto internazionale
Innovation design and material international Patent
Innovante dans le design et dans les matériaux brevet international
Innovadora tanto en diseño como en los materiales, patente internacional

NOMENCLATURA PARTI DI RICAMBIO
SPARE PARTS LIST
NOMENCLATURE PIECES DE RECHANGE
NOMENCLATURA REPUESTOS

Passaggio di corpi solidi \varnothing 25 mm
Valvola di non ritorno integrata
Galleggiante integrato
Prestazioni eccezionali

Passage of solid bodies \varnothing 25 mm
Built in non return valve
Built in float switch
Exceptional performance

Passage de corps solides \varnothing 25 mm
Clapet de non-retour intégré
Flotteur intégré
Performances exceptionnelles

Paso de cuerpos sólidos \varnothing 25 mm
Válvula anti-retorno integrada
Flotador integrado
Prestaciones excepcionales

Connettore estraibile a tenuta stagna con innesto rapido
Quick cable coupling watertight connector
Connecteur extractible étanche avec accrochage rapide
Conector extraíble estanco de acoplamiento rápido

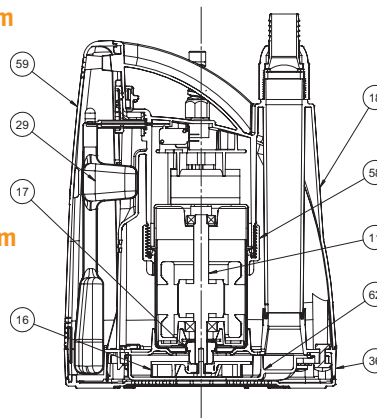

- 11 Albero con rotore – Pump shaft + rotor
Arbre + rotor – Eje rotor
- 16 Girante – Impeller
Turbine – Impulsor
- 17 Tenuta meccanica – Mechanical seal
Garniture mécanique – Cierre mecánico
- 18 Corpo pompa – Pump body
Corp de pompe – Cuerpo bomba
- 29 Galleggiante – Float switch
Flotteur – Flotador
- 36 Base filtro – Filter base
Base filtre – Filtro básico
- 58 Ghiera fissaggio motore – Motor fixing ring nut
Bague fixation moteur – Virola de fijación del motor
- 59 Copri galleggiante – Float switch cover
Couvres flottant – Tapa flotador
- 62 Voluta – Internal diffuser
Diffuseur interne – Difusor interior

TOP RANGE

ELETTROPOMPE SOMMERGIBILI PER DRENAGGIO

Le elettropompe sommergibili a girante aperta della serie VENEZIA® Vortex, sono state realizzate utilizzando i più moderni e sofisticati sistemi di progettazione d'ingegneria e design industriale. La particolare forma, l'interruttore di funzionamento automatico integrato, la possibilità di lavorare anche parzialmente immersa, la totale assenza di viti, i particolari polimeri compositi utilizzati, rendono le Venezia® una delle pompe più innovative e tecnologicamente avanzate presenti sul mercato.

Le VENEZIA® Vortex sono state progettate per il pompaggio di acque reflue, sporche o luride, non aggressive per i materiali della pompa.

Temperatura max. del liquido fino a 35 °C. (CEI EN 60335-2-41).
 Massimo passaggio libero di corpi solidi fino Ø 25 mm.

Le VENEZIA® Vortex possono lavorare anche parzialmente sommerse.

CARATTERISTICHE COSTRUTTIVE

- Corpo pompa, testata e base filtro: Syntegum 1720
- Girante: in Dynaril
- Supporto cuscinetti: in alluminio pressofuso UNI 5076
- Corpo motore: in acciaio inox Aisi 304
- Albero pompa: in acciaio inox Aisi 420 F
- Tenuta meccanica lato pompa: carbone ceramica
- Tenuta lato motore: a labbro in NBR
- 10 m cavo alimentazione tipo H07RN-F
- Immersione max. 5 m

MOTORE

- Motore ad induzione a due poli, riavvolgibile, refrigerato dal liquido pompato, con protezione IP68, isolamento classe F.
- Alimentazione monofase con motoprotettore incorporato e condensatore permanentemente inserito.
- Servizio continuo.

ÉLECTROPOMPES SUBMERSIBLES POUR DRAINAGE

Les électropompes submersibles à roue ouverte de la série VENEZIA® Vortex, ont été réalisées en utilisant les plus modernes et les plus sophistiqués systèmes de projet d'ingénierie et de design industriel. La forme particulière, l'interrupteur de fonctionnement automatique intégré, la possibilité de fonctionner même partiellement immergée, la totale absence de vis, les polymères composites particuliers utilisés, rendent les Venezia® une des pompes les plus innovantes et technologiquement avancées présentes sur le marché.

Les VENEZIA® Vortex ont été conçues pour le pompage d'eaux usées, sales ou noires, non agressives pour les matériaux de la pompe.

Température max. du liquide jusqu'à 35 °C. (CEI EN 60335-2-41).
 Passage libre maximal de corps solides jusqu'à Ø 25 mm.

Les VENEZIA® Vortex peuvent fonctionner même partiellement immergées.

CARACTERISTIQUES DE CONSTRUCTION

- Corps de pompe, bouchon et base filtre: Technopolimère
- Turbine: Technopolimère
- Support roulements: aluminium moulé sur pression UNI 5076
- Corps de moteur: en acier inox Aisi 304
- Abre de pompe: en acier inox Aisi 420 F
- Garniture mécanique partie pompe: Carbone dur - Céramique
- Garniture partie moteur: à lèvres en élastomère 10 m
- Câble d'alimentation H05RN-F
- Immersée max. 5 m

MOTORE

- Moteur à induction à deux pôles rebobinable, refroidi par le liquide pompé, protection IP68, classe d'isolation F.
- Le modèle monophasé son avec protection thermique et condensateur connecté en permanence
- Service S1.

SUBMERSIBLE DRAINING ELECTRIC PUMPS

The submersible draining pumps with open impeller of the series VENEZIA® Vortex have been developed with the most advanced and sophisticated engineering and industrial design systems. The particular form, the integrated automatic switch, the possibility to operate also if partially submerged, the total absence of screws and the particular compound polymers used, make Venezia® one of the most innovative and technological advanced pumps available or the market.

The VENEZIA® Vortex have been design to pump waste water, dirty water or sewage water, but not aggressive for the pump's materials. Liquid temperature not higher than 35 °C. (CEI EN 60335-2-41).
 Max. free passage of suspended solids up to Ø 25 mm.

The VENEZIA® Vortex may work also partially immersed.

TECHNICAL FEATURES

- Pump body, outer motor casing and base filter: Syntegum 1720
- Impeller: in Dynaril
- Bearings bracket: in die casting aluminium UNI 5076
- Motor body: stainless steel Aisi 304
- Pump shaft: stainless steel Aisi 420 F
- Pump's side mechanical seal: carbon-ceramics
- Motor's side seal: lip ring in NBR
- 10 m H07RN-F feeding cable
- Max. immersion 5 m

MOTOR

- Two poles induction rewindable motor, cooled by the pumped liquid, with protection IP 68, class F insulation.
- Single-phase feeding with incorporated motor protector and capacitor permanently connected.
- Continuous duty.

ELECTROBOMBAS SUMERGIBLES PARA DRENAJE

Le electrobombas sumergibles con impulsor abierto de la serie VENEZIA® Vortex, han sido realizadas utilizando los más modernos y sofisticados sistemas de proyectación de ingeniería y de diseño industrial. La particularidad de su forma, el interruptor de funcionamiento automático integrado, la posibilidad de trabajar incluso parcialmente inmersa, la total ausencia de tornillos, los especiales polímeros compuestos utilizados, hacen de Venezia® una de las bombas más innovadoras y tecnológicamente avanzadas presentes en el mercado.

Las VENEZIA® Vortex han sido proyectadas para el bombeo de aguas residuales, sucias o fecales, no agresivas para los materiales de la bomba. Temperatura max. del líquido hasta 35 °C. (CEI EN 60335-2-41).
 Máximo paso libre de cuerpos sólidos hasta Ø 25 mm.

Las VENEZIA® Vortex pueden trabajar incluso parcialmente sumergidas.

CARACTERISTICAS DE CONSTRUCCIÓN

- Cuerpo de bomba, Rodete, filtro y tapa con el mango: De tecnopolímero
- Rodete: De tecnopolímero
- Soporte portarrodamientos: fundición de aluminio UNI 5076
- Cuerpo de motor: de acero Inox AISI304
- Eje de la bomba: de acero Inox Aisi 420 F
- Cierre mecánico lado bombas: De cerámica y grafito
- Cierre lado motor: anillo de cierre en NBR
- Cable de alimentación :10 m H07RN-F
- Máxima inmersión :5 m

MOTORE

- Motor a induction de dos poles rebobinables, enfriado por el líquido bombeado, protección IP68, aislamiento de clase F.
- Para los modelos monofásicos, protección térmica y condensador incorporado
- Funcionamiento S1.

50 Hz

TIPO TYPE Monofase Single-phase	Potenza nominale Nominal power		Potenza assorbita Input power [W]	Condensatore Capacitor 450 V max [μF]	Corrente assorbita Input current [A] 1~ 230 V	Portata - Capacity													
	kW	HP				Prevalenza (m C.A.) Total head (m W.C.)													
						Q [m ³ /h]	0	0,6	1,2	1,8	3	4,2	5,4	6	7,2	8,4	9,6	10,8	12
Venezia Vortex 525	0.37	0.5	440	8	2.1	H [m]	6,2	5,8	5,3	5,0	4,2	3,6	2,9	2,7	2,1	1,7	1,3		
Venezia Vortex 925	0.59	0.8	610	14	2.7		8,9	8,5	8,0	7,6	6,7	5,9	5,0	4,6	3,8	3,0	2,2	1,4	0,7

a) ~ Monofase 230 V

60 Hz

TIPO TYPE Monofase Single-phase	Potenza nominale Nominal power		Potenza assorbita Input power [W]	Condensatore Capacitor 450 V max [μF]	Corrente assorbita Input current [A] 1~ 230 V	Portata - Capacity													
	kW	HP				Prevalenza (m C.A.) Total head (m W.C.)													
						Q [m ³ /h]	0	0,6	1,2	1,8	3	4,2	5,4	6	7,2	8,4	9,6	10,8	12
Venezia Vortex 525	0.37	0.5	485	10	2.2	H [m]	5,6	5,4	5,2	5,0	4,6	4,1	3,5	3,2	2,5	1,8			
Venezia Vortex 925	0.59	0.8	700	14	3.2		9,9	9,5	9,0	8,6	7,7	6,8	5,9	5,4	4,5	3,5	2,5	1,5	0,4

a) ~ Monofase 230 V

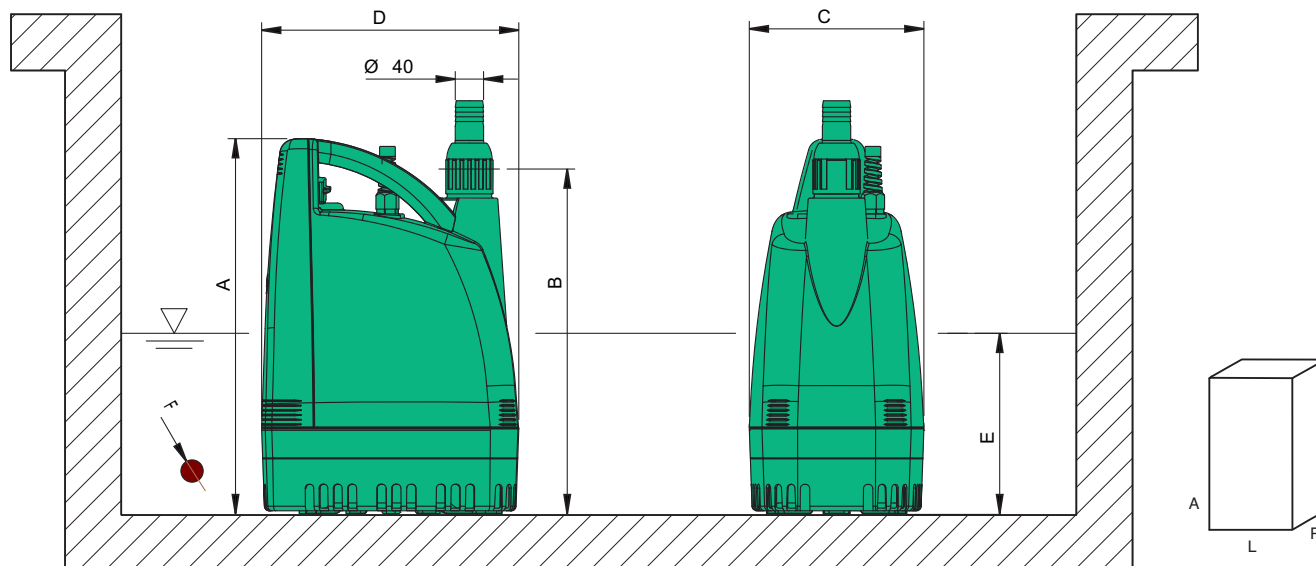

TIPO TYPE	DIMENSIONI [mm] DIMENSIONS [mm]								IMBALLO [mm] PACKING [mm]			PESO WEIGHT [kg]
	A	B	C	D	E	F	DNM	A	L	P		
Venezia 525 Vortex	400	365	175	270	120	Ø 25	1"1/4	430	280	230	5,8	
Venezia 925 Vortex	400	365	175	270	120	Ø 25	1"1/4	430	280	230	7,8	

min⁻¹ ~ 2900

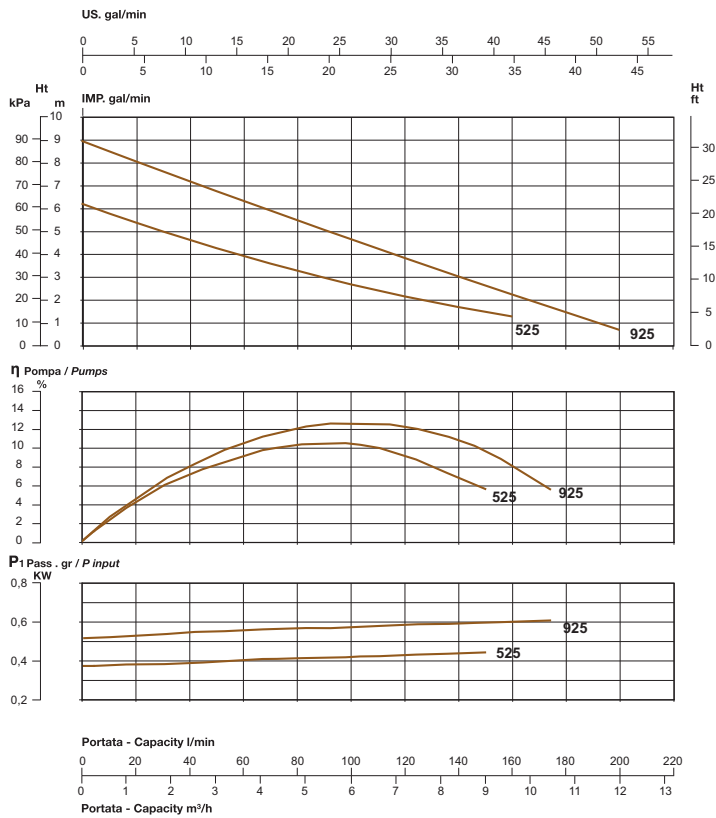

min⁻¹ ~ 3400

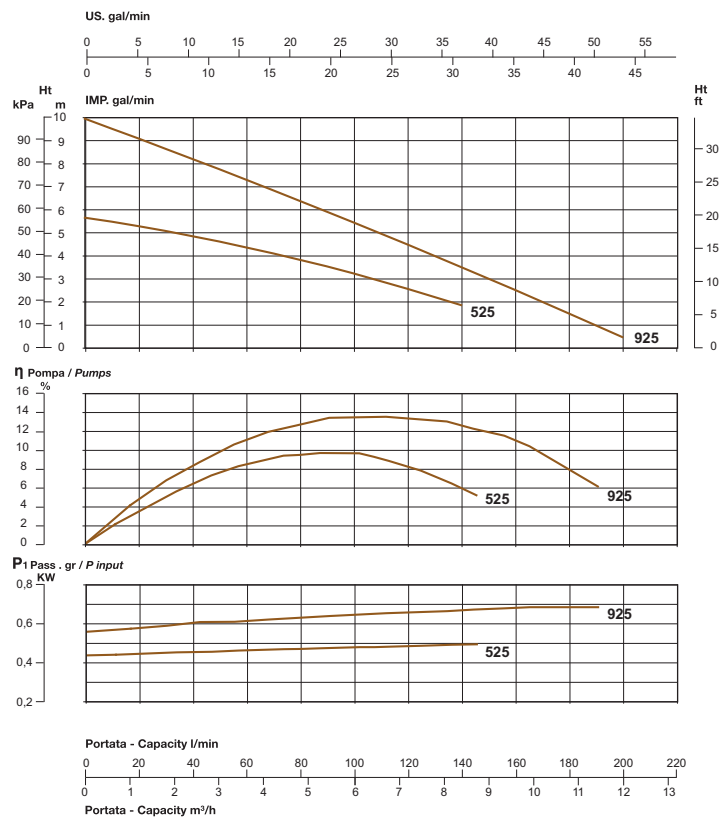

"SA"



NOMENCLATURA PARTI DI RICAMBIO
SPARE PARTS LIST
NOMENCLATURE PIECES DE RECHANGE
NOMENCLATURA REPUESTOS

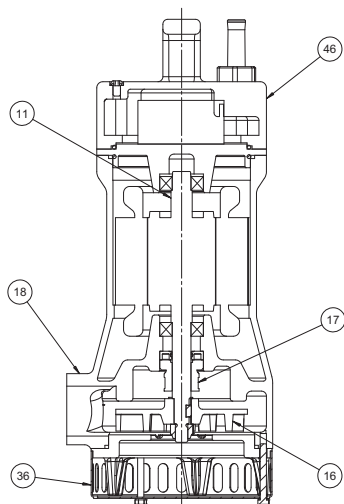

- 11** Albero con rotore – Pump shaft + rotor
Arbre + rotor – Eje rotor
- 16** Girante – Impeller
Turbine – Impulsor
- 17** Tenuta meccanica – Mechanical seal
Garniture mécanique – Cierre mecánico
- 18** Corpo pompa – Pump body
Corp de pompe – Cuerpo bomba
- 36** Base filtro – Filter base
Base filtre – Filtro básico
- 46** Coperchio con impugnatura – Cover with handle
Couvercle avec poigne – Tapa con el manego

ELETTROPOMPE SOMMERGIBILI PER DRENAGGIO

Le elettropompe sommergibili a girante aperta della serie SA sono particolarmente adatte al sollevamento di liquidi puliti o parzialmente sporchi, anche con corpi solidi in sospensione con un \varnothing massimo di 10 mm, non esplosivi e chimicamente non aggressivi per i materiali della pompa, senza parti abrasive. Temperatura max. 35 °C. (CEI EN 60335-2-41).

CARATTERISTICHE COSTRUTTIVE

- Corpo motore e coperchio con manico: ghisa G20 con trattamento anticorrosione
- Corpo pompa: ghisa G20 con trattamento anticorrosione
- Girante: ghisa G20 con trattamento anticorrosione
- Base filtro: in acciaio inox Aisi 304
- Albero pompa: acciaio inox Aisi 304
- Tenuta meccanica lato pompa: carbone ceramica
- Tenuta lato motore: a labbro in NBR
- Cavo di alimentazione: 10 m H07RN-F

MOTORE

- Motore ad induzione a due poli, riavvolgibile, con protezione IP68, isolamento classe F.
- Alimentazione monofase con motoprotettore incorporato e condensatore permanentemente inserito.
- Alimentazione trifase con protezione obbligatoria a cura dell'utente.
- Servizio continuo se completamente sommersa.

A RICHIESTA:

- Versione monofase automatica con galleggiante flottante (AUT).
- Portagomma curvo con nipples.

ÉLECTROPOMPES SUBMERSIBLES POUR DRAINAGE

Les électropompes submersibles à roue ouverte de la série SA sont particulièrement adaptées au relèvement de liquides propres ou partiellement sales, même avec des corps solides en suspension avec un \varnothing maximum de 10 mm, non explosifs et chimiquement non agressifs pour les matériaux de la pompe, sans parties abrasives. Température max. 35 °C. (CEI EN 60335-2-41).

CARACTERISTIQUES DE CONSTRUCTION

- Corps de moteur et le couvercle avec poignée: En fonte G20 avec traitement anti-corrosion
- Corps de pompe : En fonte G20 avec traitement anti-corrosion
- Turbine: En fonte G20 avec traitement anti-corrosion
- Filtre: en acier inox Aisi 304
- Abre de pompe: acier inox Aisi 304
- Garniture mécanique partie pompe: Carbone dur - Céramique
- Garniture partie moteur: à lèvres en élastomère
- Câble d'alimentation: 10 mt H07RN-F

MOTORE

- Moteur à induction à deux pôles rebobinable, refroidi par le liquide pompé, protection IP68, classe d'isolation F.
- Le modèles monophasé son avec protection thermique et condensateur connecté en permanence
- Pour les modèles triphasés, la protection est à la charge de l'utilisateur. A recommandé l'équipement conformément à la réglementation
- Service S1 (s'il est complètement immergé)

SUR DEMANDE:

- Version Monophasée avec flotteur automatique
- Adaptateur courbe avec raccord fileté en laiton

SUBMERSIBLE DRAINING ELECTRIC PUMPS

The submersible draining electric pump with open impeller series SA have been designed for pumping clear or slightly dirty liquids, non-explosive or chemically aggressive for the pump's materials, either containing suspended solids max \varnothing 10 mm, without abrasives parts. Temperatures not higher 35 °C (CEI EN 60335-2-41).

TECHNICAL FEATURES

- Motor body and cover with handle: cast iron G20 with anti-corrosive coating
- Pump body: cast iron G20 with anti-corrosive coating
- Impeller: cast iron G20 with anti-corrosive coating
- Base filter: stainless steel Aisi 304
- Pump shaft: stainless steel Aisi 304
- Pump's side seal: mechanical carbon-ceramics
- Motor's side seal: lip ring in NBR
- Feeding cable: 10 m H07RN-F

MOTOR

- Two poles induction rewindable motor with protection IP 68, class F insulation.
- Single-phase feeding with incorporated motor protector and capacitor permanently connected.
- Three-phase feeding with compulsory protection to be provided by the user.
- Continuous duty if completely submerged

ON REQUEST:

- Single-phase automatic version with float switch (AUT).
- Brass hose connector with curve 2 nipples.

ELECTROBOMBAS SUMERGIBLES DE DRENAJE

Las electrobombas sumergibles con impulsor abierto de la serie SA son especialmente adecuadas para la elevación de líquidos limpios o parcialmente sucios, incluso con cuerpos sólidos en suspensión con un \varnothing máximo de 10 mm, que no sean explosivos ni químicamente agresivos para los materiales de la bomba, sin partes abrasivas. Temperatura max. 35 °C. (CEI EN 60335-2-41).

CARACTERISTICAS DE CONSTRUCCIÓN

- Cuerpo de motor y tapa con el mango: Fundición gris G20 con tratamiento contra-corrosión
- Cuerpo de bomba: Fundición gris G20 con tratamiento contra-corrosión
- Rodete: Fundición gris G20 con tratamiento contra-corrosión
- Filtro: de acero Inox AISI304
- Eje de la bomba: de acero Inox AISI304
- Cierre mecánico lado bombas: De cerámica y grafito
- Cierre lado motor: anillo de cierre en NBR
- Cable de alimentación :10 mt H07RN-F

MOTORE

- Motor a induction de dos poles rebobinables, enfriado por el líquido bombeado, protección IP68, aislamiento de clase F.
- Para los modelos monofásicos, protección térmica y condensador incorporado
- Para los modelos trifásicos de la protección se encarga el usuario, y el equipo recomendado de acuerdo con las normas
- Funcionamiento S1 (si es completamente sumergida)

BAJO DEMANDA:

- Versión Monofásico con interruptor de nivel automático (AUT)
- Ajuste con curvas y rosca de latón

50 Hz

TIPO TYPE		Potenza nominale Nominal power		Potenza assorbita Input power [W]		Condensatore Capacitor 450 V max	Corrente assorbita Input current [A]		Portata - Capacity											
Monofase Single-phase	Trifase Three-phase	kW	HP	a	b	[μF]	1~230V	3~400V	Prevalenza (m C.A.) Total head (m W.C.)											
									Q [m ³ /h]	0	3	6	9	12	15	16,8	21,6	23,4	27	
a	b								Prevalenza (m C.A.) Total head (m W.C.)											
SA 150 M	SA 150 T	1.1	1.5	1700	1450	30	7.7	2.8	Prevalenza (m C.A.) Total head (m W.C.)											
SA 200 M	SA 200 T	1.47	2	2100	1870	36	9.2	3.3	Prevalenza (m C.A.) Total head (m W.C.)											
									H [m]	14.1	13.3	12.4	11.5	10.4	9.3	8.6	5.5	4.5		
									H [m]	15.9	15.0	14.0	13.0	12.0	10.6	9.8	6.8	5.6	3.3	

a) ~ Monofase 230 V

b) ~ Trifase 400 V

60 Hz

TIPO TYPE		Potenza nominale Nominal power		Potenza assorbita Input power [W]		Condensatore Capacitor 450 V max	Corrente assorbita Input current [A]		Portata - Capacity											
Monofase Single-phase	Trifase Three-phase	kW	HP	a	b	[μF]	1~220V	3~380V	Prevalenza (m C.A.) Total head (m W.C.)											
									Q [m ³ /h]	0	3	6	9	12	15	16,8	21,6	23,4	27	
a	b								Prevalenza (m C.A.) Total head (m W.C.)											
SA 150 M	SA 150 T	1.1	1.5	1920	1490	30	9.1	3.3	Prevalenza (m C.A.) Total head (m W.C.)											
SA 200 M	SA 200 T	1.47	2	2480	1590	36	11.4	3.6	Prevalenza (m C.A.) Total head (m W.C.)											
									H [m]	14,1	13,6	13,0	12,1	11,0	9,6	8,6	5,7	4,4		
									H [m]	17,2	16,8	16,2	15,2	14,0	12,5	11,4	8,0	6,9	4,1	

a) ~ Monofase 230 V

b) ~ Trifase 230/400 V

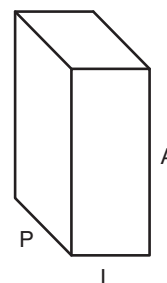
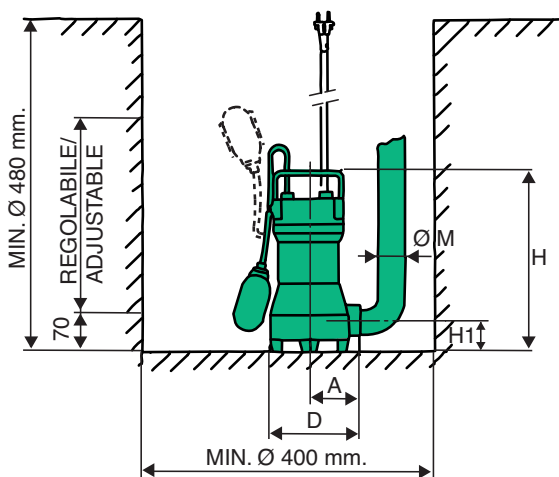

TIPO TYPE	DIMENSIONI [mm] DIMENSIONS [mm]					IMBALLO [mm] PACKING [mm]			PESO WEIGHT [kg]
	A	H1	H	D	ØM	A	L	P	
SA 150	115	87	440	205	1"1/2	250	215	460	27.8
SA 200	115	87	440	205	1"1/2	250	215	460	28.6

$\text{min}^{-1} \sim 2900$

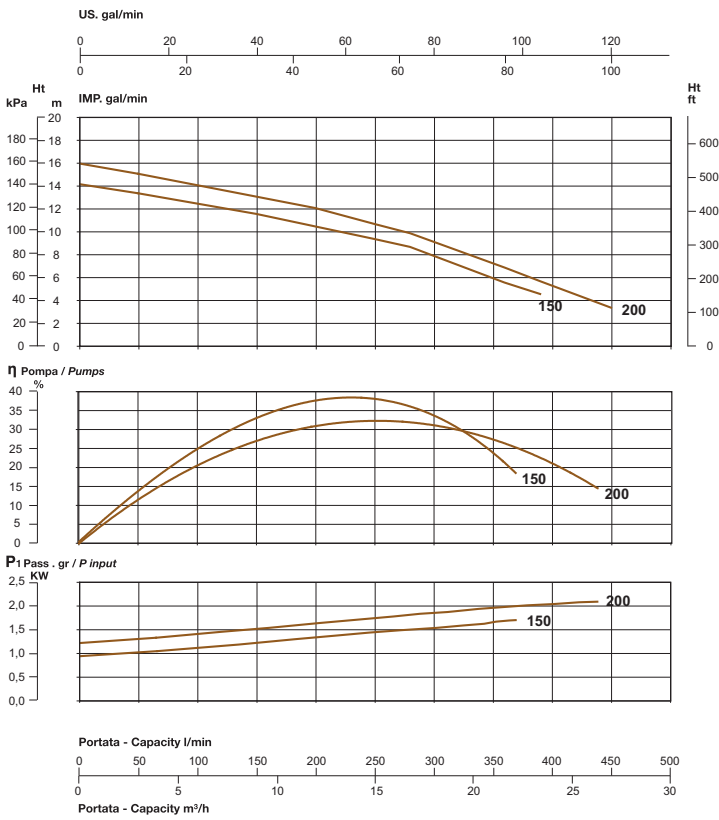

$\text{min}^{-1} \sim 3400$

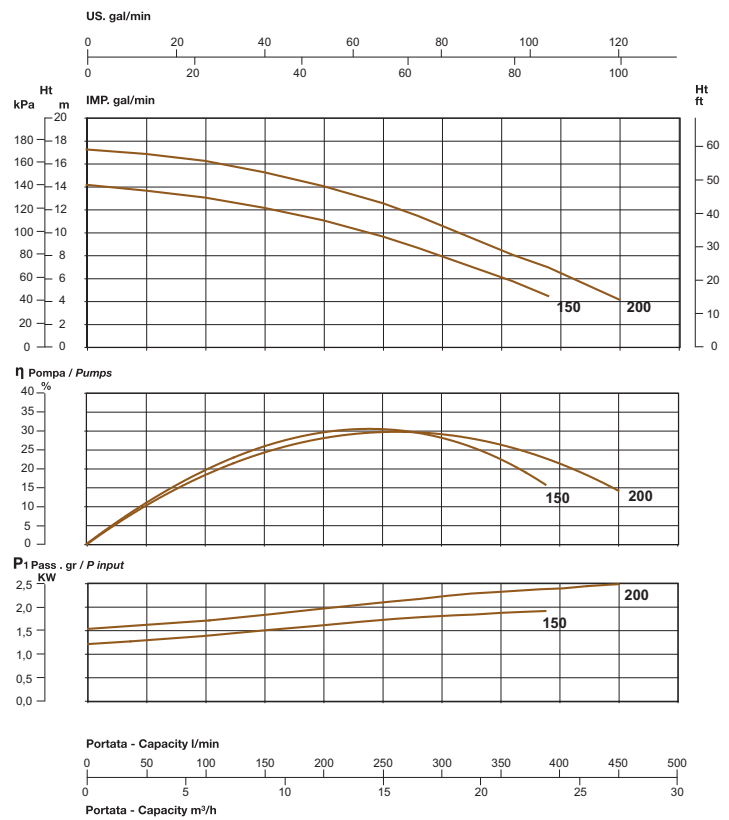

"DA"



NOMENCLATURA PARTI DI RICAMBIO
SPARE PARTS LIST
NOMENCLATURE PIECES DE RECHANGE
NOMENCLATURA REPUESTOS

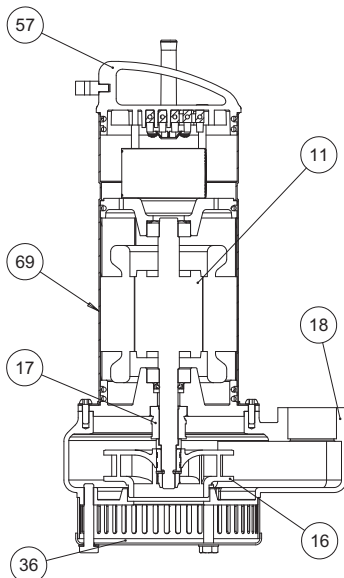

- 11** Albero con rotore – Pump shaft + rotor
Arbre + rotor – Eje rotor
- 16** Girante – Impeller
Turbine – Impulsor
- 17** Tenuta meccanica – Mechanical seal
Garniture mécanique – Cierre mecánico
- 18** Corpo pompa – Pump body
Corp de pompe – Cuerpo bomba
- 57** Manico – Handle
Poignée – Manejar
- 69** Camicia – Cover
Chemise – Camisa
- 36** Filtro - Filter
Filtre - Filtro

ELETTROPOMPE SOMMERSIBILI PER DRENAGGIO

Le elettropompe sommergibili della serie DA sono particolarmente adatte al sollevamento di liquidi puliti o parzialmente sporchi, anche con corpi solidi in sospensione con un Ø massimo di 4 mm, non esplosivi e chimicamente non aggressivi per i materiali della pompa, senza parti abrasive. Temperatura max. 35 °C. (CEI EN 60335-2-41).

CARATTERISTICHE COSTRUTTIVE

- Corpo motore: acciaio inox Aisi 304
- Corpo pompa: ghisa G20 con trattamento anticorrosione
- Girante: Tecnopolimero
- Albero pompa: acciaio inox Aisi 420
- Tenuta meccanica lato pompa: carbone - ceramica
- Tenuta meccanica lato motore: a labbro in NBR
- Cavo di alimentazione: 10 m H07RN-F

MOTORE

- Motore ad induzione a due poli, riavvolgibile, con protezione IP68, isolamento classe F.
- Alimentazione monofase con motoprotettore incorporato e condensatore permanentemente inserito.
- Alimentazione trifase con protezione obbligatoria a cura dell'utente.
- Servizio continuo se completamente sommersa.

A RICHIESTA:

- Versione monofase automatica con galleggiante flottante (AUT).

ÉLECTROPOMPES SUBMERSIBLES POUR EAUX USÉES

Les électropompes submersibles de la série DA sont particulièrement adaptées au relèvement de liquides propres ou partiellement sales, même avec des corps solides en suspension avec un Ø maximum de 4 mm, non explosifs et chimiquement non agressifs pour les matériaux de la pompe, sans parties abrasives. Température max. 35 °C. (CEI EN 60335-2-41).

CARACTERISTIQUES DE CONSTRUCTION

- Corps de moteur: acier inox Aisi 304
- Corps de pompe : En fonte G20 avec traitement anti-corrosion
- Turbine: Technopolymère
- Abre de pompe: acier inox Aisi 420
- Garniture mécanique partie pompe: Carbone dur - Céramique
- Garniture mécanique partie moteur: à lèvres en élastomère
- Câble d'alimentation: 10 m H07RN-F

MOTOR

- Moteur à induction à deux pôles rebobinable, refroidi par le liquide pompé, protection IP68, classe d'isolation F.
- Le modèles monophasé son avec protection thermique et condensateur connecté en permanence
- Pour les modèles triphasés, la protection est à la charge de l'utilisateur. A recommandé l'équipement conformément à la réglementation
- Service S1 (s'il est complètement immergé)

SUR DEMANDE:

- Version Monophasée avec flotteur automatique

SUBMERSIBLE ELECTRIC WASTEWATER PUMPS

The submersible draining electric pump series DA have been designed for pumping clear or slightly dirty liquids, non-explosive or chemically aggressive for the pump's materials, either containing suspended solids max Ø 4 mm, without abrasives parts. Temperatures not higher 35 °C (CEI EN 60335-2-41).

TECHNICAL FEATURES

- Motor body: stainless steel Aisi 304
- Pump body: cast iron G20 with anti-corrosive coating
- Impeller: Techno-polymer
- Pump shaft: stainless steel Aisi 420
- Pump's side mechanical seal: carbon - ceramics
- Motor's side seal: lip ring in NBR
- Feeding cable: 10 m H07RN-F

MOTOR

- Two poles induction rewindable motor with protection IP 68, class F insulation.
- Single-phase feeding with incorporated motor protector and capacitor permanently connected.
- Three-phase feeding with compulsory protection to be provided by the user.
- Continuous duty if completely submerged.

ON REQUEST:

- Single-phase automatic version with float switch (AUT).

ELECTROBOMBAS SUMERGIBLES PARA AGUAS RESIDUALES

Las electrobombas sumergibles de la serie DA son especialmente adecuadas para la elevación de líquidos limpios o parcialmente sucios, incluso con cuerpos sólidos en suspensión con un Ø máximo de 4 mm, que no sean explosivos ni químicamente agresivos para los materiales de la bomba, sin partes abrasivas. Temperatura max. 35 °C. (CEI EN 60335-2-41).

CARACTERISTICAS DE CONSTRUCCIÓN

- Cuerpo de motor: de acero Inox AISI304
- Cuerpo de bomba: Fundición gris G20 con tratamiento contra-corrosión
- Rodete: Tecnopolimero
- Eje de la bomba: de acero Inox Aisi 420
- Cierre mecánico lado bombas: cerámica-grafito
- Cierre mecánico lado motor: anillo de cierre en NBR
- Cable de alimentación :10 mt H07RN-F
- Máxima inmersión :5 mt

MOTOR

- Motor a inducción de dos polos rebobinables, enfriado por el líquido bombeado, protección IP68, aislamiento de clase F.
- Para los modelos monofásicos, protección térmica y condensador incorporado
- Para los modelos trifásicos de la protección se encarga el usuario y el equipo recomendado de acuerdo con las normas
- Funcionamiento S1 (si es completamente sumergida)

BAJO DEMANDA:

- Versión Monofásico con interruptor de nivel automático (AUT)

50 Hz

TIPO TYPE		Potenza nominale Nominal power		Potenza assorbita Input power [W]		Condensatore Capacitor 450 V max	Corrente assorbita Input current [A]		Portata - Capacity									
Monofase Single-phase	Trifase Three-phase	kW	HP	a	b	[μ F]	1~230V	3~400V	Q [m ³ /h]	0	3	6	9	12	15	18	21	
a	b								Q [l/s]	0	50	100	150	200	250	300	350	
Prevalenza (m C.A.) Total head (m W.C.)																		
										H [m]	11,6	11,0	10,9	10,0	9,1	7,5	6,0	
										H [m]	13,9	13,5	13,3	12,8	11,0	9,5	8,0	6,5
DA 100 M	-	0,74	1	1040	-	20	4,7	-										
DA 120 M	DA 120 T	0,88	1,2	1390	1460	25	6,2	3,8										

a) ~ Monofase 230 V

b) ~ Trifase 230/400 V

60 Hz

TIPO TYPE		Potenza nominale Nominal power		Potenza assorbita Input power [W]		Condensatore Capacitor 450 V max	Corrente assorbita Input current [A]		Portata - Capacity									
Monofase Single-phase	Trifase Three-phase	kW	HP	a	b	[μ F]	1~220V	3~380V	Q [m ³ /h]	0	3	6	9	12	15	18	21	
a	b								Q [l/s]	0	50	100	150	200	250	300	350	
Prevalenza (m C.A.) Total head (m W.C.)																		
										H [m]	11,0	10,5	10,4	9,5	8,6	7,1	5,7	
										H [m]	13,2	12,8	12,6	12,2	10,5	9,0	7,6	6,2
DA 100 M	-	0,74	1	1040	-	20	4,7	-										
DA 120 M	DA 120 T	0,88	1,2	1390	1460	25	6,2	2,7										

a) ~ Monofase 115/220 V

b) ~ Trifase 220/380 V

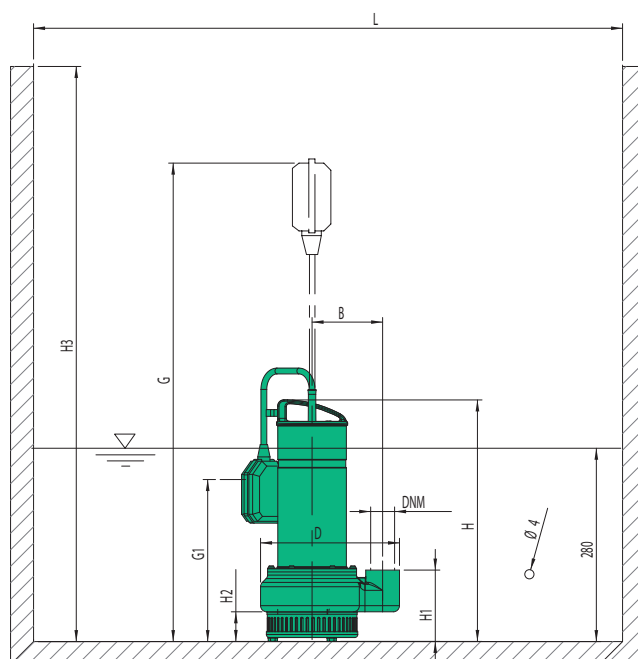

TIPO TYPE	DIMENSIONI [mm] DIMENSIONS [mm]											IMBALLO [mm] PACKING [mm]			PESO WEIGHT [kg]
	H	H1	H2	H3	B	D	F	G	G1	L	DNM	A	L	P	
DA 100	400	120	50	700	120	230	4	/	/	600X600	1" 1/4	290	610	250	14,4
DA 100 AUT	400	120	50	700	120	230	4	500	200	600X600	1" 1/4	290	610	250	14,8
DA 120	400	120	50	700	120	230	4	/	/	600X600	1" 1/4	290	610	250	15,6
DA 120 AUT	400	120	50	700	120	230	4	500	200	600X600	1" 1/4	290	610	250	16

$\text{min}^{-1} \sim 2900$

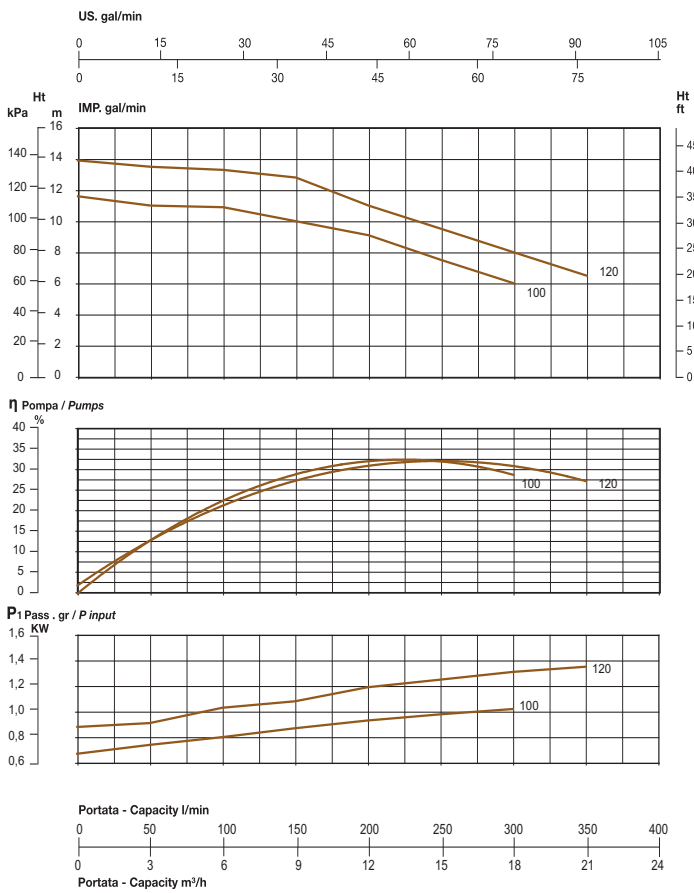

$\text{min}^{-1} \sim 3400$

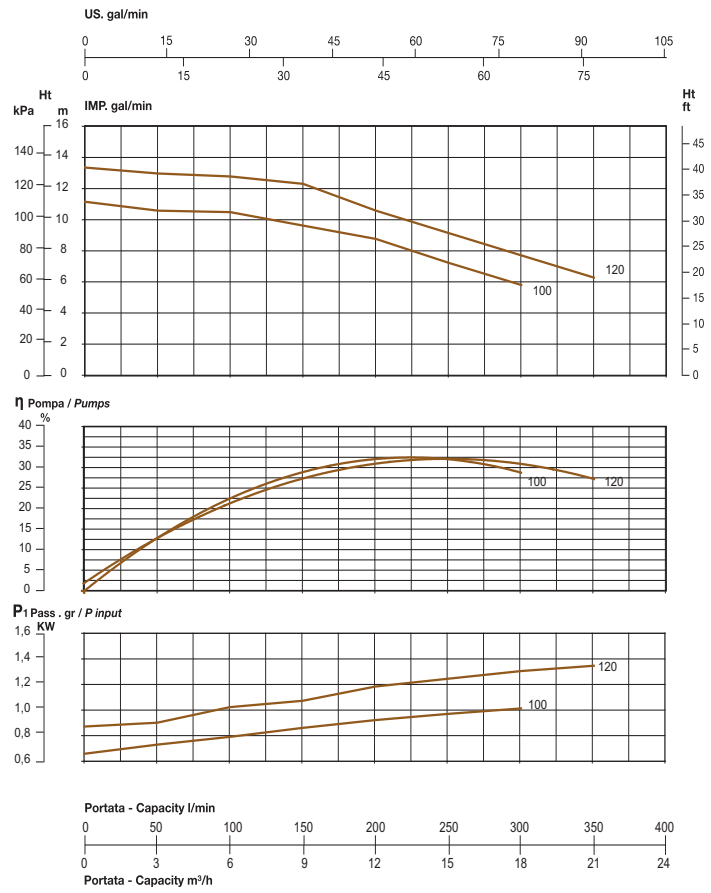

"DAX"



NOMENCLATURA PARTI DI RICAMBIO
SPARE PARTS LIST
NOMENCLATURE PIECES DE RECHANGE
NOMENCLATURA REPUESTOS

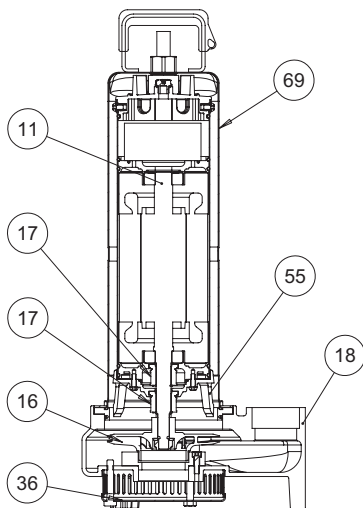

- 11** Albero con rotore – Pump shaft + rotor
Arbre + rotor – Eje rotor
- 16** Girante – Impeller
Turbine – Impulsor
- 17** Tenuta meccanica – Mechanical seal
Garniture mécanique – Cierre mecánico
- 17** Tenuta meccanica inferiore – Mechanical seal
Garniture mécanique inférieur – Cierre mecánico inferior
- 18** Corpo pompa – Pump body
Corp de pompe – Cuerpo bomba
- 36** Base filtro – Filter base
Base filtre – Filtro básico
- 55** Supporto tenuta – Seal support
Support garniture – Soporte cierre
- 69** Camicia – Cover
Chemise – Camisa
- 36** Filtro – Filter
Filtre – Filtro

ELETTROPOMPE SOMMERGIBILI PER DRENAGGIO

Le elettropompe sommergibili della serie DAX sono particolarmente adatte al sollevamento di liquidi puliti o parzialmente sporchi, anche con corpi solidi in sospensione con un Ø massimo di 4 mm, non esplosivi e chimicamente non aggressivi per i materiali della pompa, senza parti abrasive. Temperatura max. 35 °C. (CEI EN 60335-2-41).

CARATTERISTICHE COSTRUTTIVE

- Corpo motore e coperchio con manico: acciaio inox Aisi 304
- Corpo pompa: ghisa G20 con trattamento anticorrosione
- Girante: Ottone stampato UNI -EN 12165
- Albero pompa: acciaio inox Aisi 304
- Tenuta meccanica lato pompa: carburo di silicio-allumina
- Tenuta meccanica lato motore: grafite - allumina
- Connettore estraibile a tenuta stagna con innesto rapido
- Cavo di alimentazione: 10 m H07RN-F

MOTORE

- Motore ad induzione a due poli, riavvolgibile, con protezione IP68, isolamento classe F.
- Alimentazione monofase con motoprotettore incorporato e condensatore permanentemente inserito.
- Alimentazione trifase con protezione obbligatoria a cura dell'utente.
- Servizio continuo

A RICHIESTA:

- Versione monofase automatica con galleggiante flottante (AUT).

ÉLECTROPOMPES SUBMERSIBLES POUR EAUX USÉES

Les électropompes submersibles de la série DAX sont particulièrement adaptées au relèvement de liquides propres ou partiellement sales, même avec des corps solides en suspension avec un Ø maximum de 4 mm, non explosifs et chimiquement non agressifs pour les matériaux de la pompe, sans parties abrasives. Température max. 35 °C. (CEI EN 60335-2-41).

CARACTERISTIQUES DE CONSTRUCTION

- Corps de moteur et le couvercle avec la poignée: acier inox Aisi 304
- Corps de pompe : En fonte G20 avec traitement anti-corrosion
- Turbine: Laiton étampé UNI-EN 12165
- Abre de pompe: acier inox Aisi 304
- Garniture mécanique partie pompe: carbure de silicium-carbure de silicium
- Garniture mécanique partie moteur: en graphite - alumina
- Connecteur étanche extractible avec attache rapide Câble d'alimentation: 10 m H07RN-F

MOTOR

- Moteur à induction à deux pôles rebobinable, refroidi par le liquide pompé, protection IP68, classe d'isolation F.
- Le modèles monophasé son avec protection thermique et condensateur connecté en permanence
- Pour les modèles triphasés, la protection est à la charge de l'utilisateur. A recommandé l'équipement conformément à la réglementation
- Service S1

SUR DEMANDE:

- Version Monophasée avec flotteur automatique

SUBMERSIBLE DRAINING ELECTRIC PUMPS

The submersible draining electric pump series DAX have been designed for pumping clear or slightly dirty liquids, non-explosive or chemically aggressive for the pump's materials, either containing suspended solids max Ø 4 mm, without abrasives parts. Temperatures not higher 35 °C (CEI EN 60335-2-41).

TECHNICAL FEATURES

- Motor body and cover with handle: stainless steel Aisi 304
- Pump body: cast iron G20 with anti-corrosive coating
- Impeller: Stamped brass UNI-EN 12165
- Pump shaft: stainless steel Aisi 304
- Pump's side mechanical seal: silicon carbide- alumina
- Motor's side mechanical seal: graphite-alumina
- Quick cable coupling watertight connector
- Feeding cable: 10 m H07RN-F

MOTOR

- Two poles induction rewindable motor with protection IP 68, class F insulation.
- Single-phase feeding with incorporated motor protector and capacitor permanently connected.
- Three-phase feeding with compulsory protection to be provided by the user.
- Continuous duty

ON REQUEST:

- Single-phase automatic version with float switch (AUT).

ELECTROBOMBAS SUMERGIBLES PARA AGUAS RESIDUALES

Las electrobombas sumergibles de la serie DAX son especialmente adecuadas para la elevación de líquidos limpios o parcialmente sucios, incluso con cuerpos sólidos en suspensión con un Ø máximo de 4 mm, que no sean explosivos ni químicamente agresivos para los materiales de la bomba, sin partes abrasivas. Temperatura max. 35 °C. (CEI EN 60335-2-41).

CARACTERISTICAS DE CONSTRUCCIÓN

- Cuerpo de motor y tapa con el mango: de acero Inox AISI304
- Cuerpo de bomba: Fundición gris G20 con tratamiento contra-corrosión
- Rodete: De latón UNI-EN 12165
- Eje de la bomba: de acero Inox AISI304
- Cierre mecánico lado bombas: carburo de silicio y alumina
- Cierre mecánico lado motor: en grafito y alumina
- Conector extraíble impermeable con cierre rápido
- Cable de alimentación :10 mt H07RN-F
- Máxima inmersión :5 mt
- Conector extraíble impermeable con cierre rápido

MOTOR

- Motor a induction de dos poles rebobinables, enfriado por el líquido bombeado, protección IP68, aislamiento de clase F.
- Para los modelos monofásicos, protección térmica y condensador incorporado
- Para los modelos trifásicos de la protección se encarga el usuario, y el equipo recomendado de acuerdo con las normas
- funcionamiento S1

BAJO DEMANDA:

- Versión Monofásico con interruptor de nivel automático (AUT)

50 Hz

TIPO TYPE		Potenza nominale Nominal power		Potenza assorbita Input power [W]		Condensatore Capacitor 450 V max	Corrente assorbita Input current [A]		Portata - Capacity											
Monofase Single-phase	Trifase Three-phase	kW	HP	a	b	[μF]	1~230V	3~400V	Q [m ³ /h]	0	6	9	12	15	18	21	24	27	30	33
									Q [l/s]	0	100	150	200	250	300	350	400	450	500	550
										Prevalenza (m C.A.) Total head (m W.C.)										
a	b								H [m]	16,7	15,5	14,6	13,3	11,8	10,6	9,4	8	6,6	4,7	
DAX 150 M	DAX 150 T	1,1	1,5	1740	1750	30	8,2	4,3		20,3	18,0	17,0	15,8	14,6	13,5	11,9	10,8	8,7	7,2	5,5
DAX 200 M	DAX 200 T	1,47	2	1920	2040	45	9	4,4												

a) ~ Monofase 230 V

b) ~ Trifase 400 V

60 Hz

TIPO TYPE		Potenza nominale Nominal power		Potenza assorbita Input power [W]		Condensatore Capacitor 450 V max	Corrente assorbita Input current [A]		Portata - Capacity											
Monofase Single-phase	Trifase Three-phase	kW	HP	a	b	[μF]	1~220V	3~380V	Q [m ³ /h]	0	6	9	12	15	18	21	24	27	30	33
									Q [l/s]	0	100	150	200	250	300	350	400	450	500	550
										Prevalenza (m C.A.) Total head (m W.C.)										
a	b								H [m]	16,3	15,2	14,2	13,0	11,4	10,2	9	7,7	6,1	4,2	
DAX 150 M	DAX 150 T	1,1	1,5	1740	1750	30	10,9	3,6		20,5	18,1	16,9	15,9	14,5	13,3	11,9	10,5	8,4	7	5,1
DAX 200 M	DAX 200 T	1,47	2	2040	1900	45	12	4,5												

a) ~ Monofase 220 V

b) ~ Trifase 380 V

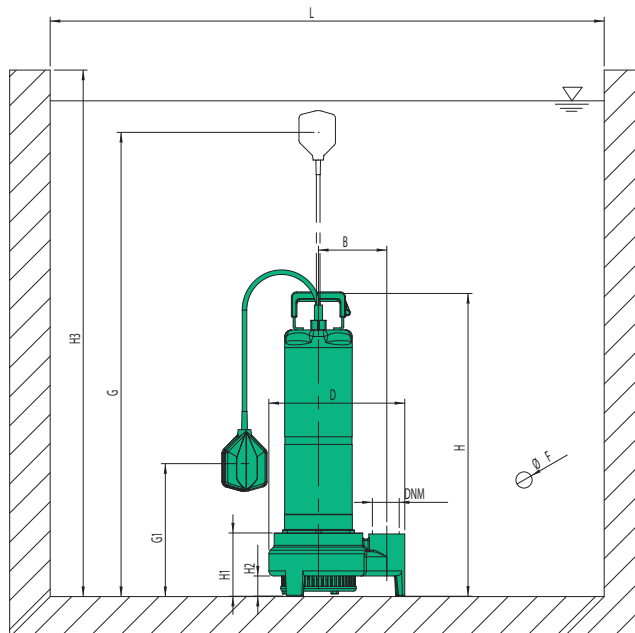

TIPO TYPE	DIMENSIONI [mm] DIMENSIONS [mm]											IMBALLO [mm] PACKING [mm]			PESO WEIGHT [kg]
	H	H1	H2	H3	B	D	F	G	G1	L	DNM	A	L	P	
DAX 150	545	125	40	700	140	270	4	-	-	600X600	2"	600	280	280	21,5
DAX 150 AUT	545	125	40	700	140	270	4	570	270	600X600	2"	600	280	280	22
DAX 200	610	125	40	700	140	270	4	-	-	600X600	2"	700	280	280	24
DAX 200 AUT	610	125	40	700	140	270	4	620	320	600X600	2"	700	280	280	24,5

min⁻¹ ~ 2900

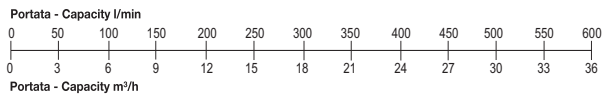
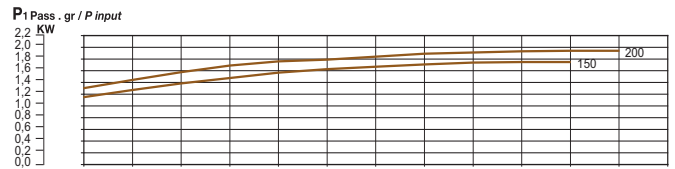
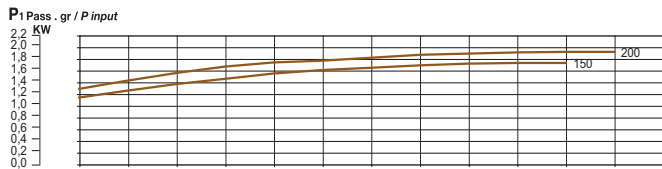
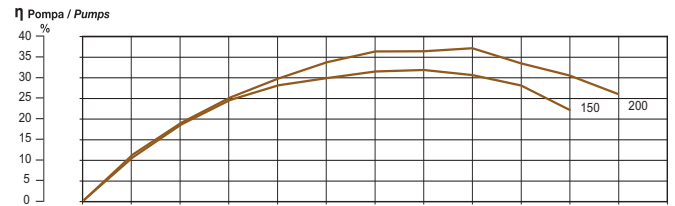
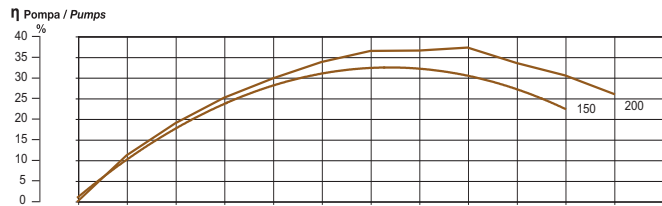
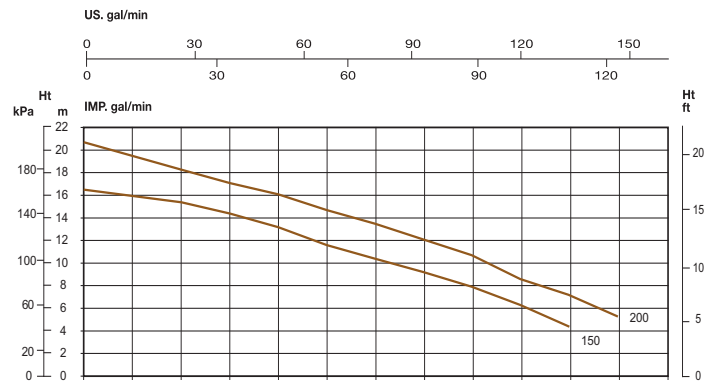
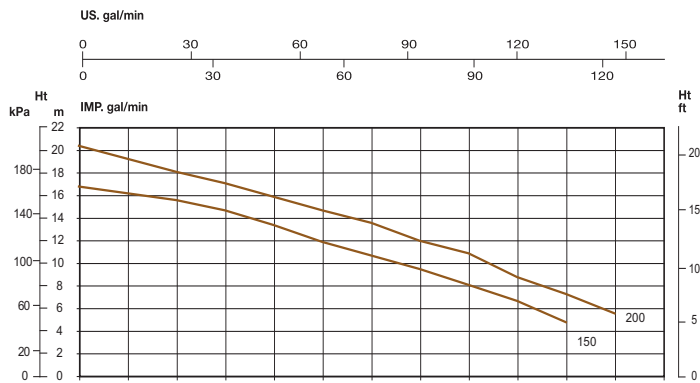

"STR"

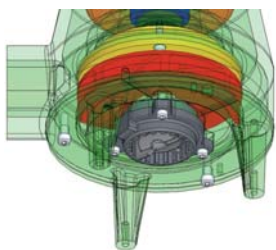

NOMENCLATURA PARTI DI RICAMBIO
SPARE PARTS LIST
NOMENCLATURE PIECES DE RECHANGE
NOMENCLATURA REPUESTOS

**Sistema Trituratore: in
microfusione d'acciaio
temperato**

**Crushing system: in
precision-cast temperate
stainless steel**

**Système Broyeur: en
microfusion d'acier
trempé**

**Sistema Triturador: en
microfusión de acero
endurecido**

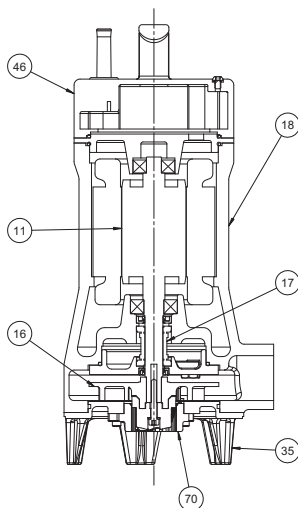

- 11 Albero con rotore – Pump shaft + rotor
Arbre + rotor – Eje rotor
- 16 Girante – Impeller
Turbine – Impulsor
- 17 Tenuta meccanica – Mechanical seal
Garniture mécanique – Cierre mecánico
- 18 Corpo pompa – Pump body
Corp de pompe – Cuerpo bomba
- 35 Base pompa – Pump base
Base pompe – Base bomba
- 46 Coperchio con impugnatura – Cover with handle
Couvercle avec poigne – Tapa con el manego
- 70 Trituratore completo – Crushing system
Triturante completo – Desfibradora completo

ELETTROPOMPE SOMMERGIBILI PER ACQUE SPORCHE CON SISTEMA TRITURATORE

Le elettropompe sommergibili con sistema tritratore della serie STR sono state progettate per tritare eventuali corpi solidi o filamentosi in sospensione e pompare liquidi luridi, non esplosivi e chimicamente non aggressivi per i materiali della pompa. Temperatura max. 35 °C (CEI EN 60335-2-41).

CARATTERISTICHE COSTRUTTIVE

- Corpo motore e coperchio con manico: ghisa G20 con trattamento anticorrosione
- Corpo pompa: ghisa G20 con trattamento anticorrosione
- Girante: ghisa G20 con trattamento anticorrosione
- Sistema Tritratore: in microfusione d'acciaio temperato AISI 440 C
- Albero pompa: acciaio inox Aisi 304
- Tenuta meccanica lato pompa: carbone ceramica
- Tenuta lato motore: a labbro in NBR
- Cavo di alimentazione: 10 m H07RN-F

MOTORE

- Motore ad induzione a due poli, riavvolgibile, con protezione IP68, isolamento classe F.
- Alimentazione monofase con condensatore incorporato e permanentemente inserito. Protezione termica amperometrica obbligatoria a cura dell'utente tramite quadro di sicurezza e controllo tipo CDA-M
- Alimentazione trifase a 400 V con Protezione termica amperometrica obbligatoria a cura dell'utente tramite quadro di sicurezza e controllo tipo CDA-T
- Servizio continuo se completamente sommersa.

A RICHIESTA:

- Versione monofase automatica con galleggiante flottante (AUT).
- Portagomma curvo con nipples.

ÉLECTROPOMPES SOMMERGIBLES POUR EAUX SALES AVEC SYSTÈME BROEUR

Les électropompes submersibles avec système broyeur de la série STR ont été conçues pour broyer d'éventuels corps solides ou filamenteux en suspension et pomper des liquides sales, non explosifs et chimiquement non agressifs pour les matériaux de la pompe. Température max. 35 °C (CEI EN 60335-2-41).

CARACTERISTIQUES DE CONSTRUCTION

- Corps de moteur et couvercle avec poignée: En fonte G20 avec traitement anti-corrosion
- Corps de pompe : En fonte G20 avec traitement anti-corrosion
- Turbine: En fonte G20 avec traitement anti-corrosion
- Système broyage : en coulée d'acier AISI 440 C tempré
- Abre de pompe: acier inox Aisi 304
- Garniture mécanique partie pompe: Carbone dur - Céramique
- Garniture partie moteur: en NBR
- Câble d'alimentation: 10 mt H07RN-F

MOTOR

- Moteur à induction à deux pôles rebobinable, protection IP68, classe d'isolation F.
- Le modèle monphasé son avec condensateur connecté en permanence. Protection requise par l'utilisateur à travers le cadre de la sécurité et le contrôle "CDA-M"
- Pour les modèles triphasés, Protection requise par l'utilisateur à travers le cadre de la sécurité et le contrôle "CDA-T"
- Service S1 (s'il est complètement immergé)

SUR DEMANDE :

- Version avec flotteur automatique (Aut.)
- Adaptateur courbe avec raccord fileté en laiton

SUBMERSIBLE ELECTRIC WASTEWATER PUMPS WITH CRUSHING SYSTEM

The submersible draining electric pumps with crushing system of the series STR have been designed to crush possible suspended solids parts or fibres and draining dirty liquids, non-explosive or chemically aggressive for the pump's materials. Temperatures not higher 35 °C (CEI EN 60335-2-41).

TECHNICAL FEATURES

- Motor body and cover with handle: cast iron G20 with anti-corrosive coating
- Pump body: cast iron G20 with anti-corrosive coating
- Impeller: cast iron G20 with anti-corrosive coating
- Crushing system: in precision-cast temperate stainless steel Aisi 440 C
- Pump shaft: stainless steel Aisi 304
- Pump's side seal: mechanical carbon-ceramics
- Motor's side seal: lip ring in NBR
- Feeding cable: 10 m H07RN-F

MOTOR

- Two poles induction rewindable motor with protection IP 68, class F insulation.
- Single-phase feeding with capacitor permanently connected with Compulsory protection against overheating with safety control panel type CDA-M.
- Three-phase feeding 400 V with Compulsory protection against overheating with safety control panel type CDA-T.
- Continuous duty if completely submerged

ON REQUEST:

- Single-phase automatic version with float switch (AUT).
- Brass hose connector with curve & nipples.

ELECTROBOMBAS SUMERGIBLES PARA AGUAS SUCIAS CON SISTEMA TRITURADOR

Las electrobombas sumergibles con sistema triturador de la serie STR han sido proyectadas para triturar eventuales cuerpos sólidos o filamentosos en suspensión y bombear líquidos sucios, que no sean explosivos ni químicamente agresivos para los materiales de la bomba. Temperatura max. 35 °C (CEI EN 60335-2-41).

CARACTERISTICAS DE CONSTRUCCIÓN

- Cuerpo de motor y tapa con el mango: Fundición gris G20 con tratamiento contra-corrosión
- Cuerpo de bomba: Fundición gris G20 con tratamiento contra-corrosión
- Rodete: Fundición gris G20 con tratamiento contra-corrosión
- Sistema de trituracion acero moldeado, AISI 440 C templado
- Eje de la bomba: de acero Inox AISI304
- Cierre mecánico lado bombas: De cerámica y grafito
- Cierre lado motor: anillo de cierre en NBR
- Cable de alimentación :10 mt H07RN-F
- Máxima inmersión :5 mt

MOTOR

- Motor a induction de dos poles rebobinables, proteccion IP68, aislamiento de clase F.
- Para los modelos monofásicos, el condensador es incorporado y obligación de proteger las bombas contra la sobrecarga a través del marco de seguridad y control "CDA-M"
- Para los modelos trifásicos obligación de proteger las bombas contra la sobrecarga a través del marco de seguridad y control "CDA-T"
- Funcionamiento S1 (si es completamente sumergida)

BAJO DEMANDA:

- Versión con interruptor de nivel automático (Aut)
- Ajuste con curvas y rosca de latón

min⁻¹ ~ 2900

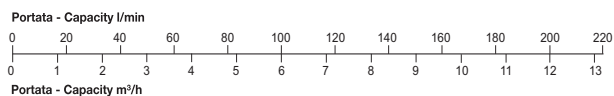
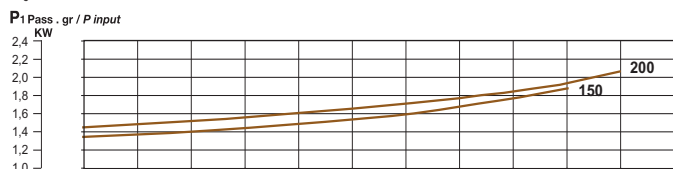
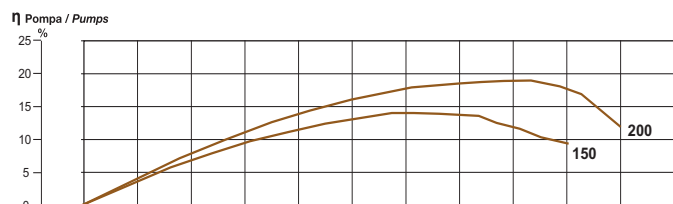
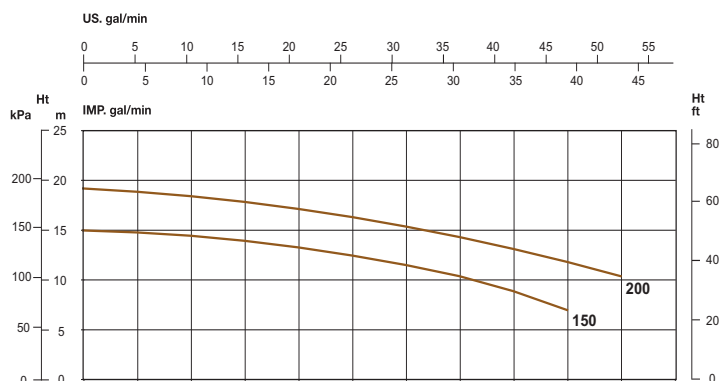

TIPO TYPE	Potenza nominale Nominal power	Potenza assorbita Input power [W]	Condensatore Capacitor 450 V max	Corrente assorbita Input current [A]	Portata - Capacity															
					Q [m³/h]	0	1.2	2.4	3.6	4.8	6	7.2	8.4	9.6	10.8	12				
Monofase Single-phase					Q [l/1']	0	20	40	60	80	100	120	140	160	180	200				
					Prevalenza (m C.A.) Total head (m W.C.)															
a	b	kW	HP	a	b	[μF]	1~230V	3~400V	H [m]	14,9	14,7	14,3	13,8	13,2	12,4	11,4	10,3	8,8	6,9	
STR 150 M	STR 150 T	1.1	1.5	1900	1600	36	8.5	2.7	H [m]	19,1	18,8	18,3	17,7	17,0	16,2	15,3	14,2	13,0	11,7	10,3
	STR 200 T	1.47	2	-	2000	-	-	3.6												

a) ~ Monofase 230 V

b) ~ Trifase 400 V

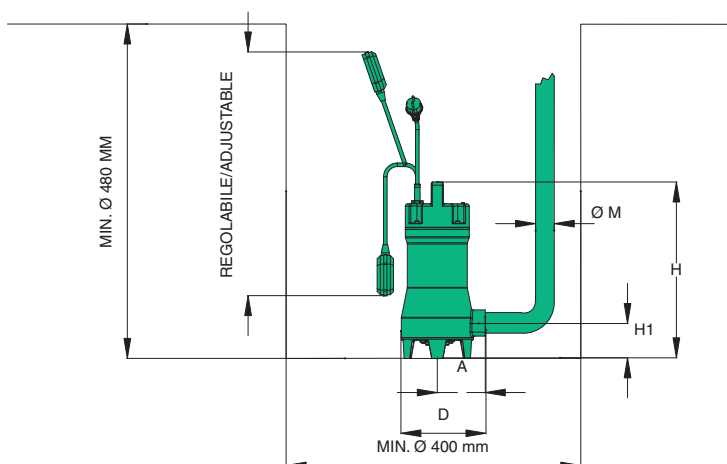

TIPO TYPE	DIMENSIONI [mm] DIMENSIONS [mm]					IMBALLO [mm] PACKING [mm]			PESO WEIGHT [kg]
	A	H1	H	D	ØM	A	L	P	
STR 150	115	87	440	205	1"1/2	250	215	460	27.8
STR 200	115	87	440	205	1"1/2	250	215	460	28.6

"DVJ"



NOMENCLATURA PARTI DI RICAMBIO
SPARE PARTS LIST
NOMENCLATURE PIECES DE RECHANGE
NOMENCLATURA REPUESTOS

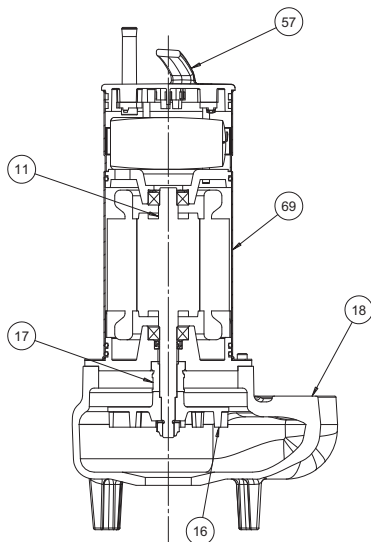

- 11** Albero con rotore – Pump shaft + rotor
Arbre + rotor – Eje rotor
- 16** Girante – Impeller
Turbine – Impulsor
- 17** Tenuta meccanica – Mechanical seal
Garniture mécanique – Cierre mecánico
- 18** Corpo pompa – Pump body
Corp de pompe – Cuerpo bomba
- 57** Manico – Handle
Poignée – Manejar
- 69** Camicia – Cover
Chemise – Camisa

ELETTROPOMPE SOMMERGIBILI PER ACQUE REFLUE

Le elettropompe sommergibili con girante a vortice della serie DVJ sono state progettate per pompare liquidi sporchi, anche con corpi solidi in sospensione con un Ø massimo di 40 mm, non esplosivi e chimicamente non aggressivi per i materiali della pompa.
 Temperatura max. 35 °C (CEI EN 60335-2-41).

CARATTERISTICHE COSTRUTTIVE

- Corpo motore: acciaio inox Aisi 304
- Corpo pompa: ghisa G20 con trattamento anticorrosione
- Girante: ghisa G20 con trattamento anticorrosione
- Albero pompa: acciaio inox Aisi 420
- Tenuta meccanica lato pompa: carbone - ceramica
- Tenuta lato motore: a labbro in NBR
- Cavo di alimentazione: 10 m H07RN-F

MOTORE

- Motore ad induzione a due poli, riavvolgibile, con protezione IP68, isolamento classe F.
- Alimentazione monofase con motoprotettore incorporato e condensatore permanentemente inserito.
- Alimentazione trifase con protezione obbligatoria a cura dell'utente.
- Servizio continuo se completamente sommersa.

A RICHIESTA:

- Versione monofase automatica con galleggiante flottante (AUT).
- Portagomma Ø 50 in ottone.

ÉLECTROPOMPES SUBMERSIBLES POUR EAUX USÉES

Les électropompes submersibles à roue vortex de la série DVJ ont été conçues pour pomper des liquides sales, même avec des corps solides en suspension avec un Ø maximum de 40 mm, non explosifs et chimiquement non agressifs pour les matériaux de la pompe.
 Température max. 35 °C (CEI EN 60335-2-41).

CARACTERISTIQUES DE CONSTRUCTION

- Corps de moteur: acier inox Aisi 304
- Corps de pompe : En fonte G20 avec traitement anti-corrosion
- Turbine: En fonte G20 avec traitement anti-corrosion
- Abre de pompe: acier inox Aisi 420
- Garniture mécanique partie pompe: Carbone dur - Céramique
- Garniture partie moteur: à lèvres en élastomère
- Câble d'alimentation: 10 m H07RN-F

MOTOR

- Moteur à induction à deux pôles rebobinable, refroidi par le liquide pompé, protection IP68, classe d'isolation F.
- Le modèles monophasé son avec protection thermique et condensateur connecté en permanence
- Pour les modèles triphasés, la protection est à la charge de l'utilisateur. A recommandé l'équipement conformément à la réglementation
- Service S1

SUR DEMANDE:

- Version Monophasée avec flotteur automatique
- Raccord Ø 50 en laiton

SUBMERSIBLE ELECTRIC WASTEWATER PUMPS

The submersible draining electric pump with vortex impeller series DVJ have been designed for pumping dirty liquids, non-explosive or chemically aggressive for the pump's materials, either containing suspended solids max Ø 40 mm.
 Temperatures not higher 35 °C (CEI EN 60335-2-41).

TECHNICAL FEATURES

- Motor body: stainless steel Aisi 304
- Pump body: cast iron G20 with anti-corrosive coating
- Impeller: cast iron G20 with anti-corrosive coating
- Pump shaft: stainless steel Aisi 420
- Pump's side mechanical seal: carbon - ceramics
- Motor's side seal: lip ring in NBR
- Feeding cable: 10 m H07RN-F

MOTOR

- Two poles induction rewindable motor with protection IP 68, class F insulation.
- Single-phase feeding with incorporated motor protector and capacitor permanently connected.
- Three-phase feeding with compulsory protection to be provided by the user.
- Continuous duty if completely submerged.

ON REQUEST:

- Single-phase automatic version with float switch (AUT).
- Brass hose connector Ø 50 mm.

ELECTROBOMBAS SUMERGIBLES PARA AGUAS RESIDUALES

Las electrobombas sumergibles con impulsor de torbellino de la serie DVJ han sido proyectadas para bombear líquidos sucios incluso con cuerpos sólidos en suspensión con un Ø máximo de 40 mm, no explosivos y químicamente no agresivos para los materiales de la bomba.
 Temperatura max. 35 °C (CEI EN 60335-2-41).

CARACTERISTICAS DE CONSTRUCCIÓN

- Cuerpo de motor: de acero Inox AISI304
- Cuerpo de bomba: Fundición gris G20 con tratamiento contra-corrosión
- Rodete: Fundición gris G20 con tratamiento contra-corrosión
- Eje de la bomba: de acero Inox Aisi 420
- Cierre mecánico lado bombas: cerámica-grafito
- Cierre lado motor: anillo de cierre en NBR
- Cable de alimentación :10 mt H07RN-F
- Máxima inmersión :5 mt

MOTOR

- Motor a inducción de dos polos rebobinables, enfriado por el líquido bombeado, protección IP68, aislamiento de clase F.
- Para los modelos monofásicos, protección térmica y condensador incorporado
- Para los modelos trifásicos de la protección se encarga el usuario y el equipo recomendado de acuerdo con las normas
- Funcionamiento S1

BAJO DEMANDA:

- Versión Monofásico con interruptor de nivel automático (AUT)
- Ajuste de Ø 50 en latón

50 Hz

TIPO TYPE		Potenza nominale Nominal power		Potenza assorbita Input power [W]		Condensatore Capacitor 450 V max	Corrente assorbita Input current [A]		Portata - Capacity																					
Monofase Single-phase	Trifase Three-phase	kW	HP	a	b	[μ F]	1~230V	3~400V	Q [m ³ /h]	0	3	6	9	12	15	18	21	24	Q [l/s]	0	50	100	150	200	250	300	350	400		
a	b								Prevalenza (m C.A.) Total head (m W.C.)																					
DVJ 100 M	-	0,74	1	980	-	20	4,6	-	H [m]	8,2	6,9	6,0	5,0	3,9	2,6	1,4														
DVJ 120 M	DVJ 120 T	0,89	1,2	1500	1510	25	6,8	2,9		9,9	8,8	7,7	6,8	5,9	5,1	4,1	3,3	2,0												

a) ~ Monofase 230 V

b) ~ Trifase 400 V

60 Hz

TIPO TYPE		Potenza nominale Nominal power		Potenza assorbita Input power [W]		Condensatore Capacitor 450 V max	Corrente assorbita Input current [A]		Portata - Capacity																					
Monofase Single-phase	Trifase Three-phase	kW	HP	a	b	[μ F]	1~ 220 V	3~380 V	Q [m ³ /h]	0	3	6	9	12	15	18	21	24	Q [l/s]	0	50	100	150	200	250	300	350	400		
a	b								Prevalenza (m C.A.) Total head (m W.C.)																					
DVJ 100 M	-	0,74	1	1000	-	20	4,8	-	H [m]	7,8	6,6	5,7	4,7	3,7	2,5	1,3														
DVJ 120 M	DVJ 120 T	0,88	1,2	1480	1500	25	6,4	2,7		9,4	8,3	7,4	6,4	5,6	4,8	3,9	3,1	1,9												

a) ~ Monofase 230 V

b) ~ Trifase 400 V

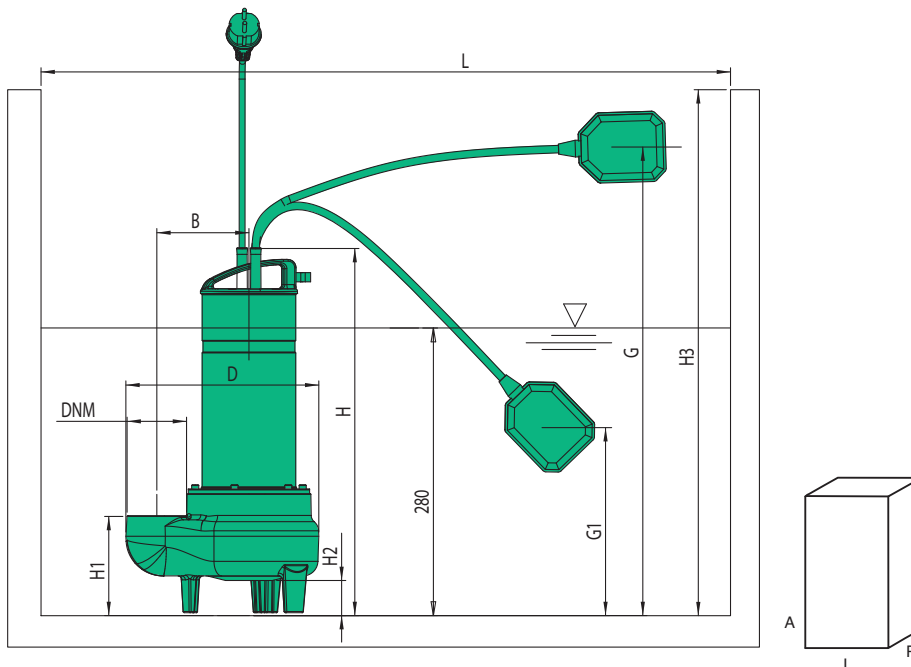

TIPO TYPE	DIMENSIONI [mm] DIMENSIONS [mm]											IMBALLO [mm] PACKING [mm]			PESO WEIGHT [kg]	
	H	H1	H2	H3	B	D	F	G	G1	L	DNM	A	L	P		
DVJ 100	440	120	40	850	120	230	40				600X600	2"	290	610	250	14,8
DVJ 100 AUT	440	120	40	850	120	230	40	700	200		600X600	2"	290	610	250	15,2
DVJ 120	440	120	40	850	120	230	40				600X600	2"	290	610	250	16
DVJ 120 AUT	440	120	40	850	120	230	40	700	200		600X600	2"	290	610	250	16,4

min⁻¹ ~ 2900

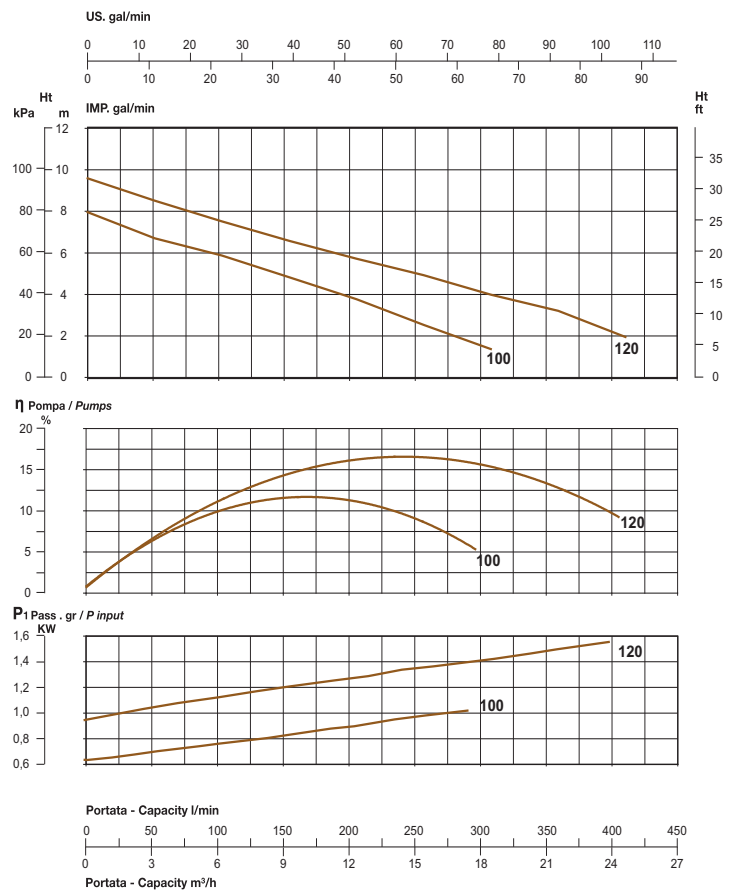
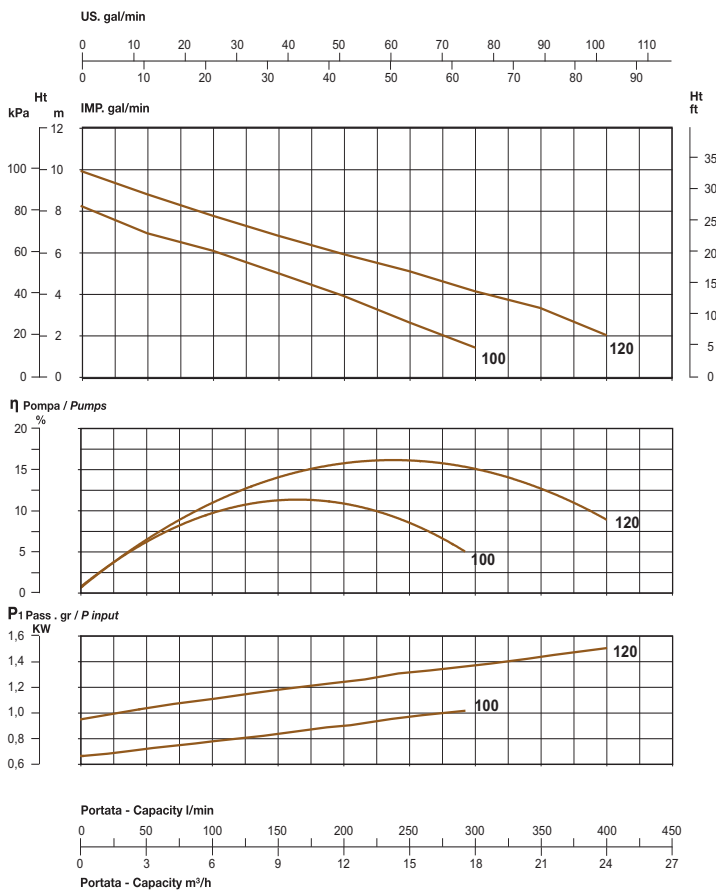

"DVX"

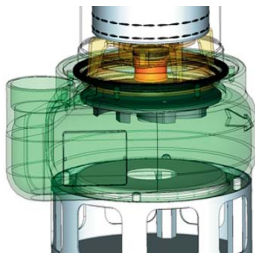

Alte prestazioni
High performance
Performances élevées
Altas prestaciones

NOMENCLATURA PARTI DI RICAMBIO
SPARE PARTS LIST
NOMENCLATURE PIECES DE RECHANGE
NOMENCLATURA REPUESTOS

Sistema di adescamento sicuro
Servizio continuo parzialmente sommersa
Connettore estraibile a tenuta stagna con innesto rapido
Anti air-lock system
Continuous duty partially submerged
Quick cable coupling watertight connector
Système d'amorçage sûr
Service continu partiellement immergé
Connecteur extractible étanche avec accrochage rapide
Sistema de cebado seguro
Servicio continuo parcialmente sumergida
Conector extraíble estanco de acoplamiento rápido

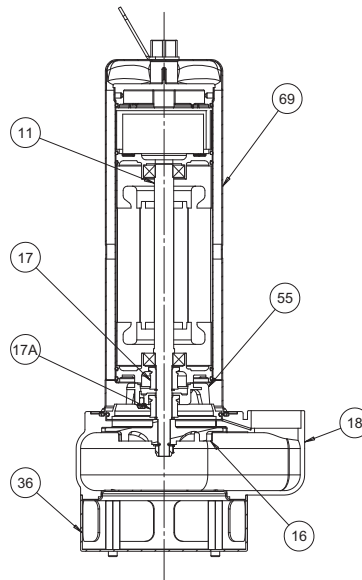

- 11** Albero con rotore – Pump shaft + rotor
Arbre + rotor – Eje rotor
- 16** Girante – Impeller
Turbine – Impulsor
- 17** Tenuta meccanica – Mechanical seal
Garniture mécanique – Cierre mecánico
- 17A** Tenuta meccanica inferiore – Mechanical seal
Garniture mécanique inférieur – Cierre mecánico inferior
- 18** Corpo pompa – Pump body
Corp de pompe – Cuerpo bomba
- 36** Base filtro – Filter base
Base filtre – Filtro básico
- 55** Supporto tenuta – Seal support
Support garniture – Soporte cierre
- 69** Camicia – Cover
Chemise – Camisa

TOP RANGE

ELETTROPOMPE SOMMERGIBILI PER DRENAGGIO

Le elettropompe sommergibili con girante a vortice della serie DVX sono state progettate per pompare liquidi sporchi, anche con corpi solidi in sospensione con un Ø massimo di 50 mm, non esplosivi e chimicamente non aggressivi per i materiali della pompa. Temperatura max. 35 °C (CEI EN 60335-2-41).

CARATTERISTICHE COSTRUTTIVE

- Corpo motore e coperchio con manico: acciaio inox Aisi 304
- Corpo pompa: ghisa G20 con trattamento anticorrosione
- Girante: ghisa G20 con trattamento anticorrosione
- Albero pompa: acciaio inox Aisi 304
- Tenuta meccanica lato pompa: carburo di silicio-allumina
- Connettore estraibile a tenuta stagna con innesto rapido
- Cavo di alimentazione: 10 m H07RN-F

MOTORE

- Motore ad induzione a due poli, riavvolgibile, con protezione IP68, isolamento classe F.
- Alimentazione monofase con motoprotettore incorporato e condensatore permanentemente inserito.
- Alimentazione trifase con protezione obbligatoria a cura dell'utente.
- Servizio continuo

A RICHIESTA:

- Versione monofase automatica con galleggiante flottante (AUT).
- Portagomma Ø 60 in ottone.

ÉLECTROPOMPES SOMMERGIBLES POUR EAUX USÉES

Les électropompes submersibles à roue vortex de la série DVX ont été conçues pour pomper des liquides sales, même avec des corps solides en suspension avec un Ø maximum de 50 mm, non explosifs et chimiquement non agressifs pour les matériaux de la pompe. Température max. 35 °C (CEI EN 60335-2-41).

CARACTERISTIQUES DE CONSTRUCTION

- Corps de moteur et le couvercle avec la poignée: acier inox Aisi 304
- Corps de pompe : En fonte G20 avec traitement anti-corrosion
- Turbine: En fonte G20 avec traitement anti-corrosion
- Abre de pompe: acier inox Aisi 304
- Garniture mécanique partie pompe: carbure de silicium-carbure de silicium Garniture mécanique partie moteur: graphite - ceramique
- Connecteur étanche extractible • avec attache rapide Câble d'alimentation: 10 m H07RN-F

MOTOR

- Moteur à induction à deux pôles rebobinable, refroidi par le liquide pompé, protection IP68, classe d'isolation F.
- Le modèles monophasés son avec protection thermique et condensateur connecté en permanence
- Pour les modèles triphasés, la protection est à la charge de l'utilisateur. A recommandé l'équipement conformément à la réglementation
- Service S1

SUR DEMANDE:

- Version Monophasée avec flotteur automatique
- Raccord Ø 50 en laiton

SUBMERSIBLE DRAINING ELECTRIC PUMPS

The submersible draining electric pump with vortex impeller series DVX have been designed for pumping dirty liquids, non-explosive or chemically aggressive for the pump's materials, either containing suspended solids max Ø 50 mm. 35 °C (CEI EN 60335-2-41).

TECHNICAL FEATURES

- Motor body and cover with handle: stainless steel Aisi 304
- Pump body: cast iron G20 with anti-corrosive coating
- Impeller: cast iron G20 with anti-corrosive coating
- Pump shaft: stainless steel Aisi 304
- Pump's side mechanical seal: silicon carbide- alumina
- Motor's side seal: graphite-alumina
- Quick cable coupling watertight connector
- Feeding cable: 10 m H07RN-F

MOTOR

- Two poles induction rewindable motor with protection IP 68, class F insulation.
- Single-phase feeding with incorporated motor protector and capacitor permanently connected.
- Three-phase feeding with compulsory protection to be provided by the user.
- Continuous duty

ON REQUEST:

- Single-phase automatic version with float switch (AUT).
- Brass hose connector Ø 60 mm.

ELECTROBOMBAS SUMERGIBLES PARA AGUAS RESIDUALES

Las electrobombas sumergibles con impulsor de torbellino de la serie DVX han sido proyectadas para bombear líquidos sucios incluso con cuerpos sólidos en suspensión con un Ø máximo de 50 mm, no explosivos y químicamente no agresivos para los materiales de la bomba. Temperatura max. 35 °C (CEI EN 60335-2-41).

CARACTERISTICAS DE CONSTRUCCIÓN

- Cuerpo de motor y tapa con el mango: de acero Inox AISI304
- Cuerpo de bomba: Fundición gris G20 con tratamiento contra-corrosión
- Rodete: Fundición gris G20 con tratamiento contra-corrosión
- Eje de la bomba: de acero Inox AISI304
- Cierre mecánico lado bombas: carburo de silicio y alúmina
- Cierre mecánico lado motor: cerámica-grafito
- Conector extraíble impermeable con cierre rápido
- Cable de alimentación :10 mt H07RN-F
- Máxima inmersión :5 mt
- Conector extraíble impermeable con cierre rápido

MOTOR

- Motor a induction de dos poles rebobinables, enfriado por el líquido bombeado, protección IP68, aislamiento de clase F.
- Para los modelos monofásicos, protección térmica y condensador incorporado
- Para los modelos trifásicos de la protección se encarga el usuario y el equipo recomendado de acuerdo con las normas
- Funcionamiento S1

BAJO DEMANDA:

- Versión Monofásico con interruptor de nivel automático (AUT)
- ajuste de Ø 50 en latón

min⁻¹ ~ 2900

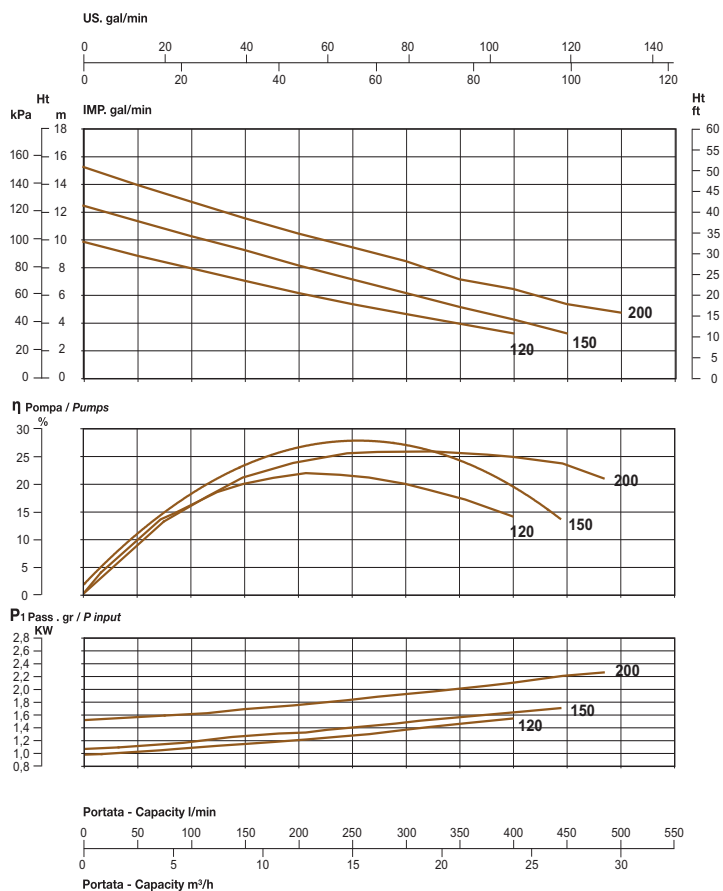

min⁻¹ ~ 3400

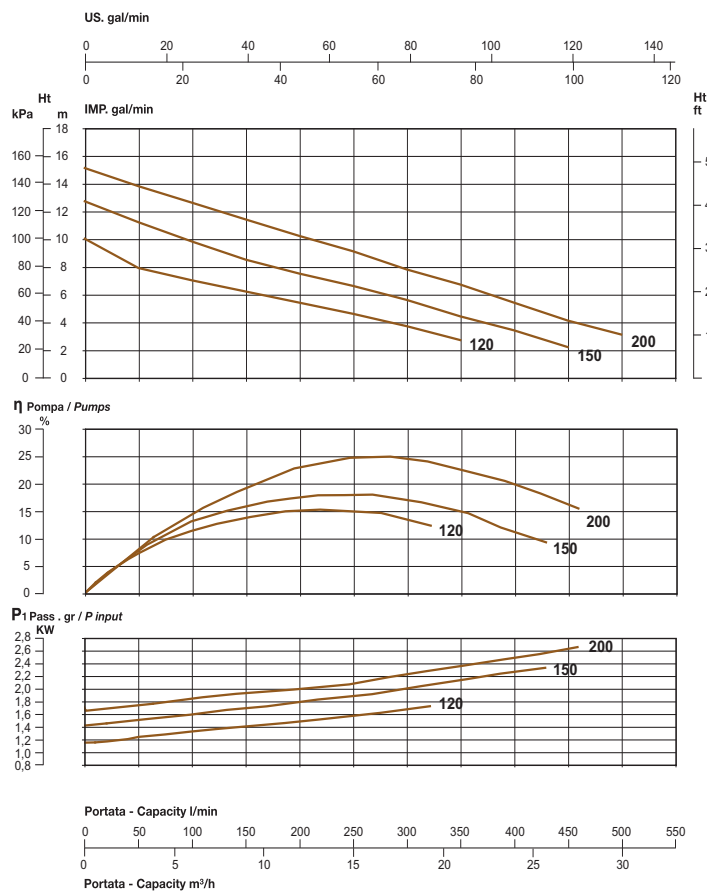

"DV25"



NOMENCLATURA PARTI DI RICAMBIO
SPARE PARTS LIST
NOMENCLATURE PIECES DE RECHANGE
NOMENCLATURA REPUESTOS

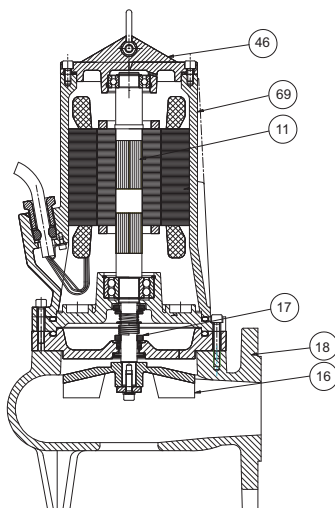

- 11** Albero con rotore – Pump shaft + rotor
Arbre + rotor – Eje rotor
- 16** Girante – Impeller
Turbine – Impulsor
- 17** Tenuta meccanica – Mechanical seal
Garniture mécanique – Cierre mecánico
- 18** Corpo pompa – Pump body
Corp de pompe – Cuerpo bomba
- 57** Manico – Handle
Poignée – Manejar
- 69** Camicia – Cover
Chemise – Camisa

ELETTROPOMPE SOMMERGIBILI PER ACQUE REFLUE

Le elettropompe sommergibili con girante a vortice non intasabile della serie DV 25 sono state progettate per pompare liquidi luridi, anche con corpi solidi in sospensione con un Ø massimo di 62 mm, chimicamente non aggressivi per i materiali della pompa. Temperatura max. 35 °C (CEI EN 60335-2-41).

CARATTERISTICHE COSTRUTTIVE

- Corpo motore: ghisa G20 con trattamento anticorrosione
- Corpo pompa: ghisa G20 con trattamento anticorrosione
- Girante: a vortice in ghisa G20 con trattamento anticorrosione
- Albero pompa: acciaio inox Aisi 303
- Tenuta meccanica lato pompa: carburo di silicio-carburo di silicio
- Tenuta lato motore: a labbro in NBR (tenuta meccanica in carburo di silicio a richiesta)
- Controflange filettate: acciaio zincato complete di guarnizioni in EPDM
- Cavo di alimentazione: 10 m in Neoprene H07RN-F

MOTORE

- Motore ad induzione a due poli o quattro poli, riavvolgibile, con protezione IP68, isolamento classe F.
- Alimentazione trifase ad avviamento diretto con protezione obbligatoria a cura dell'utente.
- Servizio continuo entro i campi di lavoro previsti e se completamente immersa.

A RICHIESTA:

- Protettori termici incorporati nell'avvolgimento.
- Sonda per rilevamento di eventuali infiltrazioni di liquido nella camera olio.
- Cavo elettrico di alimentazione per avviamento stella triangolo.
- Piede d'accoppiamento e dispositivo di discesa rapida mediante tubi di guida.

ÉLECTROPOMPES SUBMERSIBLES POUR EAUX USÉES

Les électropompes submersibles à roue vortex non obturable de la série DV 25 ont été conçues pour pomper des liquides sales, même avec des corps solides en suspension avec un Ø maximum de 62 mm, chimiquement non agressifs pour les matériaux de la pompe. Température max. 35 °C (CEI EN 60335-2-41).

CARACTERISTIQUES DE CONSTRUCTION

- Corps de moteur: En fonte G20 avec traitement anti-corrosion
- Corps de pompe: En fonte G20 avec traitement anti-corrosion
- Turbine: vortex en fonte G20 avec traitement anti-corrosion
- Abre de pompe: acier inox Aisi 303
- Garniture mécanique partie pompe: carbure de silicium-carbure de silicium
- Garniture partie moteur: à lèvres en élastomère (Garniture mécanique en carbure di siliciun sur demande)
- Contre brides filettées: en acier galvanisé avec joints en EPDM
- Câble d'alimentation: 10 mt H07RN-F

MOTOR

- Moteur à induction à deux pôles rebobinable, protection IP68, classe d'isolation F.
- Pour les modèles triphasés, la protection est à la charge de l'utilisateur. A recommandé l'équipement conformément à la réglementation
- service S1 (s'il est complètement immergé)

SUR DEMANDE:

- La sonde de détection de fuite de liquide dans la chambre à huile.
- Câble d'alimentation électrique pour démarreur étoile-triangle.
- Dispositif d'accouplement des pieds et raccord rapide.

SUBMERSIBLE ELECTRIC WASTEWATER PUMPS

The submersible electric wastewater pumps with non-clog vortex impeller of the series DV 25 have been designed to pump waste water, also with suspended solids with a max. Ø 62 mm, chemically not aggressive for the pumps' material. Temperature not higher than 35 °C (CEI EN 60335-2-41).

TECHNICAL FEATURES

- Motor body: cast iron G20 with anti-corrosive coating
- Pump body: cast iron G20 with anti-corrosive coating
- Impeller: vortex impeller in cast iron G20 with anti-corrosive coating
- Pump shaft: stainless steel Aisi 303
- Mechanical seal pump side: silicon carbide-silicon carbide;
- Motor side seal: lip-seal in NBR (mechanical seal in silicon carbide on request)
- Threaded counter flange: galvanized steel complete with EPDM gaskets
- Feeding cable: 10 m in Neoprene H07RN-F

MOTOR

- Two or four poles induction rewindable motor with protection IP 68, class F insulation.
- Compulsory three-phase feeding protection with DOL starting is to be supplied by the user.
- Continuous duty within the range areas and if completely submerged.

ON REQUEST:

- Thermal protection built-in to the motor winding.
- Seal probe to detect water ingress into oil chamber.
- Electric power cable for star-delta starting.
- Coupling foot and rapid guide device.

ELECTROBOMBAS SUMERGIBLES PARA AGUAS RESIDUALES

Las electrobombas sumergibles con impulsor de torbellino no atascable de la serie DV 25 han sido proyectadas para bombear líquidos fecales incluso con cuerpos sólidos en suspensión con un Ø máximo de 62 mm, químicamente no agresivos para los materiales de la bomba. Temperatura max. 35 °C (CEI EN 60335-2-41).

CARACTERISTICAS DE CONSTRUCCIÓN

- Cuerpo de motor: Fundición gris G20 con tratamiento contra-corrosión
- Cuerpo de bomba: Fundición gris G20 con tratamiento contra-corrosión
- Rodete: vortex Fundición gris G20 con tratamiento contra-corrosión
- Eje de la bomba: de acero Inox Aisi 303
- Cierre mecánico lado bombas: carburo de silicio - carburo de silicio
- Cierre lado motor: anillo de cierre en NBR (Cierre mecánico carburo de silicio bajo petición)
- Contra bridas roscadas: de acero galvanizado con juntas de EPDM
- Cable de alimentación :10 mt H07RN-F
- Máxima inmersión :5 mt

MOTOR

- Motor a inducción de dos polos rebobinables, protección IP68, aislamiento de clase F.
- Para los modelos trifásicos de la protección se encarga el usuario y el equipo recomendado de acuerdo con las normas
- Funcionamiento S1 (si es completamente sumergida)

BAJO DEMANDA:

- Sonda para la detección de cualquier fuga de líquido en la cámara de aceite.
- Cable eléctrico de alimentación para la estrella-triángulo
- Pie de acoplamiento y de elevación rápida.

"DV30"



NOMENCLATURA PARTI DI RICAMBIO
SPARE PARTS LIST
NOMENCLATURE PIECES DE RECHANGE
NOMENCLATURA REPUESTOS

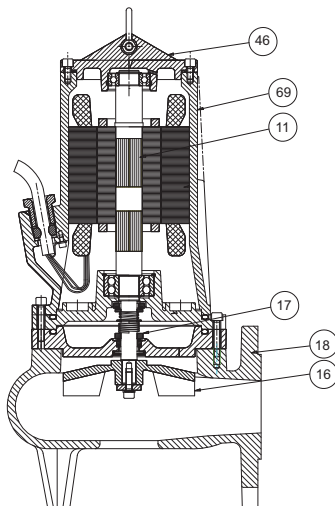

- 11** Albero con rotore – Pump shaft + rotor
Arbre + rotor – Eje rotor
- 16** Girante – Impeller
Turbine – Impulsor
- 17** Tenuta meccanica – Mechanical seal
Garniture mécanique – Cierre mecánico
- 18** Corpo pompa – Pump body
Corp de pompe – Cuerpo bomba
- 57** Manico – Handle
Poignée – Manejar
- 69** Camicia – Cover
Chemise – Camisa

ELETTROPOMPE SOMMERGIBILI PER ACQUE REFLUE 3"

Le elettropompe sommergibili con girante a vortice non intasabile della serie DV30 sono state progettate per pompare liquidi luridi, anche con corpi solidi in sospensione con un Ø massimo di 67 mm, chimicamente non aggressivi per i materiali della pompa. Temperatura max. 35 °C (CEI EN 60335-2-41).

CARATTERISTICHE COSTRUTTIVE

- Corpo motore: ghisa meccanica G20 con trattamento anticorrosione;
- Corpo pompa: ghisa meccanica G20 con trattamento anticorrosione;
- Girante: a vortice in ghisa meccanica G20 con trattamento anticorrosione;
- Albero pompa: acciaio inox Aisi 303;
- Tenuta meccanica lato pompa: carburo di silicio-carburo di silicio;
- Tenuta lato motore: carburo di silicio-allumina;
- Controflange filettate: acciaio zincato complete di guarnizioni in EPDM;
- Cavo di alimentazione: 10 m in neoprene H07RN-F.

MOTORE

- Motore ad induzione a due poli o quattro poli, riavvolgibile, con protezione IP68, isolamento classe F.
- Alimentazione trifase ad avviamento diretto con protezione obbligatoria a cura dell'utente.
- Servizio continuo entro i campi di lavoro previsti e se completamente immersa.

A RICHIESTA:

- Protettori termici incorporati nell'avvolgimento.
- Sonda per rilevamento di eventuali infiltrazioni di liquido nella camera olio.
- Cavo elettrico di alimentazione per avviamento stella triangolo.
- Piede d'accoppiamento e dispositivo di discesa rapida mediante tubi di guida.
- Esecuzione antideflagrante a norme Atex

ÉLECTROPOMPES SUBMERSIBLES POUR EAUX USÉES

Les électropompes submersibles à roue vortex non obturable de la série DV 30 ont été conçues pour pomper des liquides sales, même avec des corps solides en suspension avec un Ø maximum de 67 mm, chimiquement non agressifs pour les matériaux de la pompe. Température max. 35 °C (CEI EN 60335-2-41).

CARACTERISTIQUES DE CONSTRUCTION

- Corps de moteur: En fonte G20 avec traitement anti-corrosion;
- Corps de pompe: En fonte G20 avec traitement anti-corrosion;
- Turbine: vortex en fonte G20 avec traitement anti-corrosion;
- Abre de pompe: acier inox Aisi 303;
- Garniture mécanique partie pompe: carbure de silicium-carbure de silicium;
- Garniture partie moteur: carbure de silicium-alumina;
- Contre brides filetées: en acier galvanisé avec joints en EPDM
- Câble d'alimentation: 10 mt H07RN-F.

MOTOR

- Moteur à induction à deux pôles rebobinable, protection IP68, classe d'isolation F.
- Pour les modèles triphasés, la protection est à la charge de l'utilisateur. A recommandé l'équipement conformément à la réglementation
- service S1 (s'il est complètement immergé)

SUR DEMANDE:

- La sonde de détection de fuite de liquide dans la chambre à huile.
- Câble d'alimentation électrique pour démarreur étoile-triangle.
- Dispositif d'accouplement des pieds et raccord rapide.

SUBMERSIBLE ELECTRIC WASTEWATER PUMPS 3"

The submersible electric wastewater pumps with non-clog vortex impeller of the series DV 30 have been designed to pump waste water, also with suspended solids with a max. Ø 67 mm, chemically not aggressive for the pumps' material. Temperature not higher than 35 °C (CEI EN 60335-2-41).

TECHNICAL FEATURES

- Motor body: cast iron G20 with anti-corrosive coating
- Pump body: cast iron G20 with anti-corrosive coating
- Impeller: vortex impeller in cast iron G20 with anti-corrosive coating
- Pump shaft: stainless steel Aisi 303
- Mechanical seal pump side: silicon carbide-silicon carbide
- Motor side seal: silicon carbide-alumina
- Threaded counter flange: galvanized steel complete with EPDM gaskets
- Feeding cable: 10 m in Neoprene H07RN-F.

MOTOR

- Two or four poles induction rewindable motor with protection IP 68, class F insulation.
- Compulsory three-phase feeding protection with DOL starting is to be supplied by the user.
- Continuous duty within the range areas and if completely submerged.

ON REQUEST:

- Thermal protection built-in to the motor winding.
- Seal probe to detect water ingress into oil chamber.
- Electric power cable for star-delta starting.
- Coupling foot and rapid guide rails device.
- Explosion-proof execution as per Atex directive.

ELECTROBOMBAS SUMERGIBLES PARA AGUAS RESIDUALES

Las electrobombas sumergibles con impulsor de torbellino no atascable de la serie DV 30 han sido proyectadas para bombear líquidos fecales incluso con cuerpos sólidos en suspensión con un Ø máximo de 67 mm, químicamente no agresivos para los materiales de la bomba. Temperatura max. 35 °C (CEI EN 60335-2-41).

CARACTERISTICAS DE CONSTRUCCIÓN

- Cuerpo de motor: Fundición gris G20 con tratamiento contra-corrosión;
- Cuerpo de bomba: Fundición gris G20 con tratamiento contra-corrosión;
- Rodete: vortex Fundición gris G20 con tratamiento contra-corrosión
- Eje de la bomba: de acero Inox Aisi 303;
- Cierre mecánico lado bombas: carburo de silicio-silicio
- Cierre lado motor: carburo de silicio y alumina
- Contra bridas roscadas: de acero galvanizado con juntas de EPDM
- Cable de alimentación: 10 mt H07RN-F
- Máxima inmersión: 5 mt

MOTOR

- Motor a induction de dos poles rebobinables, proteccion IP68, aislamiento de clase F.
- Para los modelos trifásicos de la protección se encarga el usuario, y el equipo recomendado de acuerdo con las normas
- Funcionamiento S1 (si es completamente sumergida)

BAJO DEMANDA:

- Sonda para la detección de cualquier fuga de líquido en la cámara de aceite.
- Cable eléctrico de alimentación para la estrella-triángulo
- Pie de acoplamiento y de elevación rápida.

50 Hz

TIPO TYPE Trifase Three-phase	Potenza nominale Nominal power		Potenza assorbita Input power [W]	Giri min RPM	Corrente assorbita Input current [A]	Portata - Capacity																									
	kW	HP				Prevalenza (m C.A.) Total head (m W.C.)																									
						Q [m ³ /h]	0	3	6	9	12	15	18	21	24	27	30	33	36	39	42	45									
						Q [l/']	0	50	100	150	200	250	300	350	400	450	500	550	600	650	700	750									
						Prevalenza (m C.A.) Total head (m W.C.)																									
						H [m]	9,0	8,8	8,7	8,5	8,3	8,1	7,8	7,5	7,2	6,8	6,4	5,9	5,4	4,8	4,3										
DV 25/250T4	1,85	2,5	2500	1450	4,5		15,6	15,4	14,9	14,3	13,6	12,8	11,9	10,9	10,0	9,0	8,0	6,9	5,9	4,8	3,8	2,8									
DV 25/250T2	1,85	2,5	2600	2850	4,7		18,0	17,6	17,0	16,4	15,6	14,9	14,0	13,0	12,2	11,3	10,3	9,3	8,3	7,2	6,0	5,0									
DV 25/300T2	2,2	3	3310	2850	6,1	19,0	18,8	18,3	17,8	17,0	16,2	15,2	14,3	13,3	12,4	11,4	10,4	9,4	8,3												
DV 25/400T2	3	4	3190	2850	5,8																										

b) ~ Trifase 400 V

60 Hz

TIPO TYPE Trifase Three-phase	Potenza nominale Nominal power		Potenza assorbita Input power [W]	Giri min RPM	Corrente assorbita Input current [A]	Portata - Capacity																									
	kW	HP				Prevalenza (m C.A.) Total head (m W.C.)																									
						Q [m ³ /h]	0	3	6	9	12	15	18	21	24	27	30	33	36	39	42	45									
						Q [l/']	0	50	100	150	200	250	300	350	400	450	500	550	600	650	700	750									
						Prevalenza (m C.A.) Total head (m W.C.)																									
						H [m]	9,0	8,8	8,7	8,5	8,3	8,1	7,8	7,5	7,2	6,8	6,4	5,9	5,4	4,8	4,3										
DV 25/250T4	1,85	2,5	2520	1710	4,5		15,6	15,4	14,9	14,3	13,6	12,8	11,9	10,9	10	9	8	6,9	5,9	4,8	3,8	2,8									
DV 25/250T2	1,85	2,5	2600	3400	4,5		18,0	17,6	17,0	16,4	15,6	14,9	14	13	12,2	11,3	10,3	9,3	8,3	7,2	6	5									
DV 25/300T2	2,2	3	3290	3400	5,4	19,0	18,8	18,3	17,8	17,0	16,2	15,2	14,3	13,3	12,4	11,4	10,4	9,4	8,3												
DV 25/400T2	3	4	3280	3400	6																										

b) ~ Trifase 400 V

50 Hz

TIPO TYPE Trifase Three-phase	Potenza nominale Nominal power		Potenza assorbita Input power [W]	Giri min RPM	Corrente assorbita Input current [A]	Portata - Capacity																							
	kW	HP				Prevalenza (m C.A.) Total head (m W.C.)																							
						Q [m ³ /h]	0	6	12	18	24	30	36	42	48	54	60	66											
						Q [l/']	0	100	200	300	400	500	600	700	800	900	1000	1100											
						Prevalenza (m C.A.) Total head (m W.C.)																							
						H [m]	6,0	5,8	5,6	5,4	5,1	4,8	4,4	4,1	3,8	3,5	3,1	2,8											
DV 30/300T4	2,2	3	4800	1450	5,6		12,0	10,7	9,5	8,3	7,0	6	5	4	3,2	2,5	1,8	1											
DV 30/300T2	2,2	3	4110	2850	5,3		15,4	14,5	13,2	12,0	10,8	9,3	8	6,8	5,7	4,7	3,8												
DV 30/400T2	3	4	4950	2850	6,5		18,7	18,2	17,5	16,5	15,3	14	12,6	11	9,4	7,9	6,2	5											
DV 30/550T2	4	5,5	5800	2850	8,5		25,0	24,1	23,4	22,6	21,9	21	20,2	19,4	18,5	17,5	16,5	15,3											
DV 30/750T2	5,5	7,5	7220	2850	12																								

b) ~ Trifase 400 V

60 Hz

TIPO TYPE Trifase Three-phase	Potenza nominale Nominal power		Potenza assorbita Input power [W]	Giri min RPM	Corrente assorbita Input current [A]	Portata - Capacity																							
	kW	HP				Prevalenza (m C.A.) Total head (m W.C.)																							
						Q [m ³ /h]	0	6	12	18	24	30	36	42	48	54	60	66											
						Q [l/']	0	100	200	300	400	500	600	700	800	900	1000	1100											
						Prevalenza (m C.A.) Total head (m W.C.)																							
						H [m]	6,0	5,8	5,6	5,4	5,1	4,8	4,4	4,1	3,8	3,5	3,1	2,8											
DV 30/300T4	2,2	3	4800	1730	5,6		12,0	10,7	9,5	8,3	7,0	6	5	4	3,2	2,5	1,8	1											
DV 30/300T2	2,2	3	4200	3400	5,3		15,4	14,5	13,2	12,0	10,8	9,3	8	6,8	5,4	4,2	3												
DV 30/400T2	3	4	4950	3400	6,5		18,7	18,2	17,5	16,5	15,3	14	12,6	11	9,4	7,9	6,2	5											
DV 30/550T2	4	5,5	5750	3400	8,5		25,0	24,1	23,4	22,6	21,9	21	20,2	19,4	18,5	17,5	16,5	15,3											
DV 30/750T2	5,5	7,5	6740	3400	12,3																								

b) ~ Trifase 400 V

min⁻¹ ~ 2900

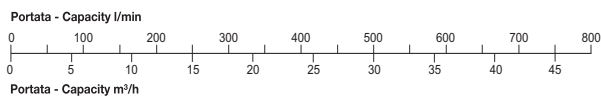
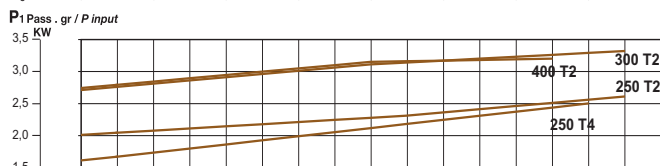
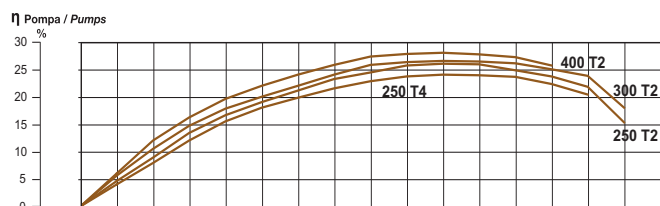
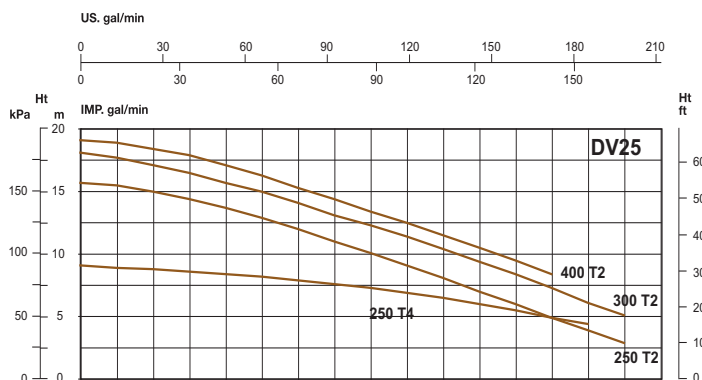

min⁻¹ ~ 3400

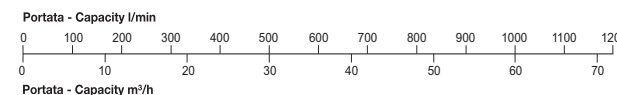
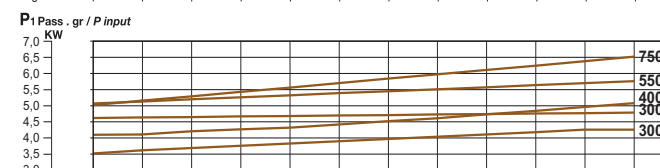
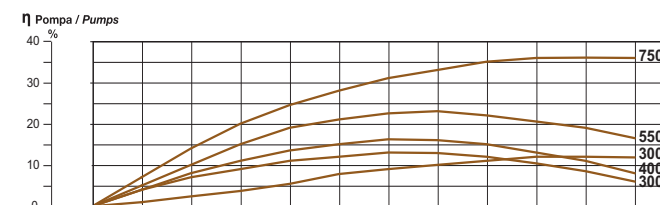
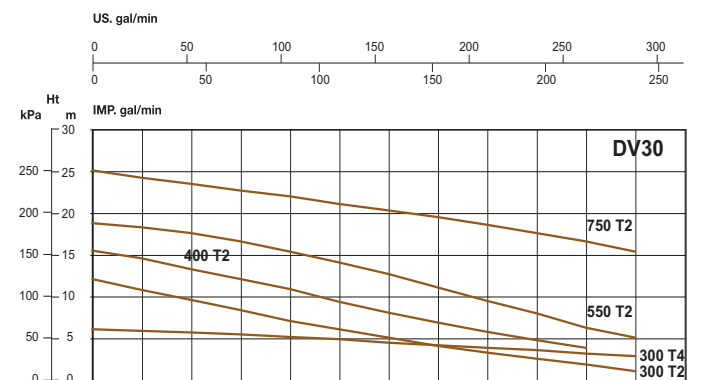
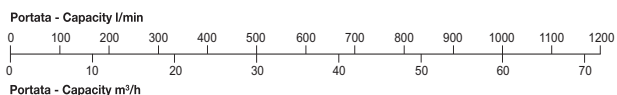
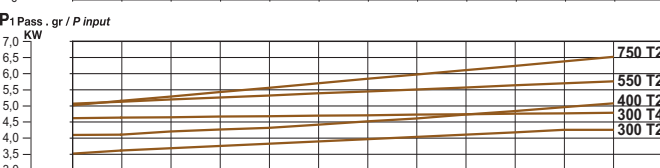
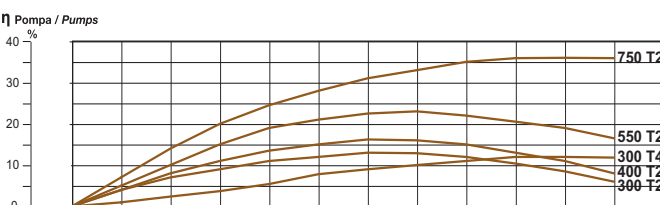
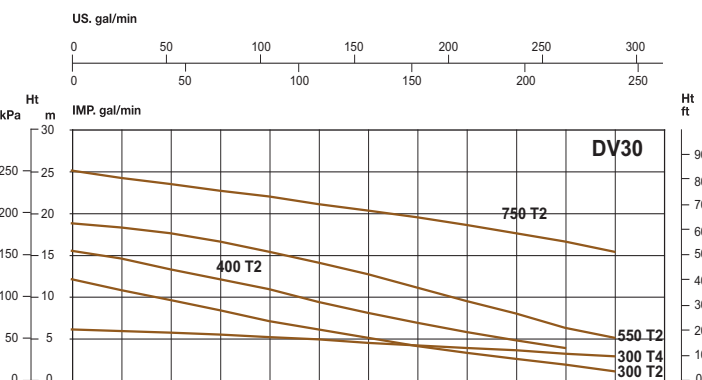
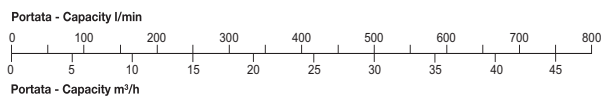
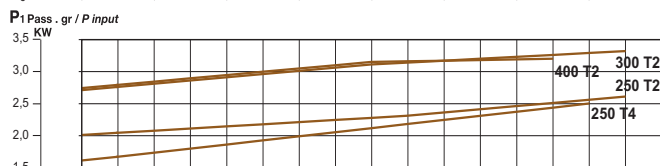
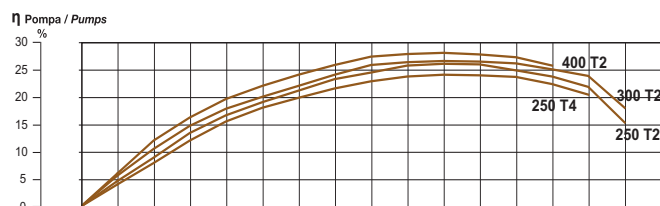
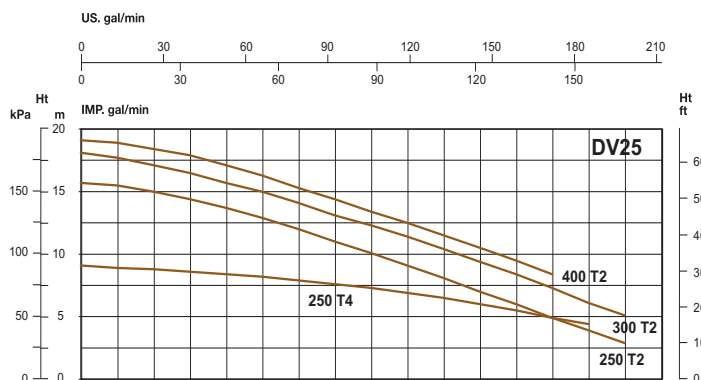

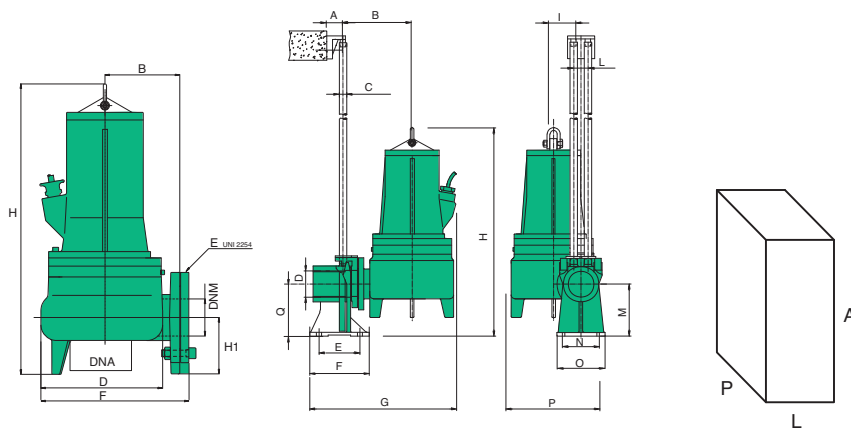

TIPO TYPE	DIMENSIONI [mm] DIMENSIONS [mm]								IMBALLO [mm] PACKING [mm]			PESO WEIGHT [kg]
	B	D	E	F	H	H1	DNA	DNM	A	L	P	
DV 25/250T4	145	217	Ø 2" 1/2	260	515	90	62	62	570	270	320	45
DV 25/250T2	145	217	Ø 2" 1/2	260	515	90	62	62	570	270	320	41
DV 25/300T2	145	217	Ø 2" 1/2	260	515	90	62	62	570	270	320	40
DV 25/400T2	145	217	Ø 2" 1/2	260	515	90	62	62	570	270	320	47

+ KIT	A	B	C	D	H	Q	E	F	G	I	L	M	N	O	P
	80	180	Ø 3/4"	Ø 2"1/2	610	140	110	150	500	75	38	140	100	130	246

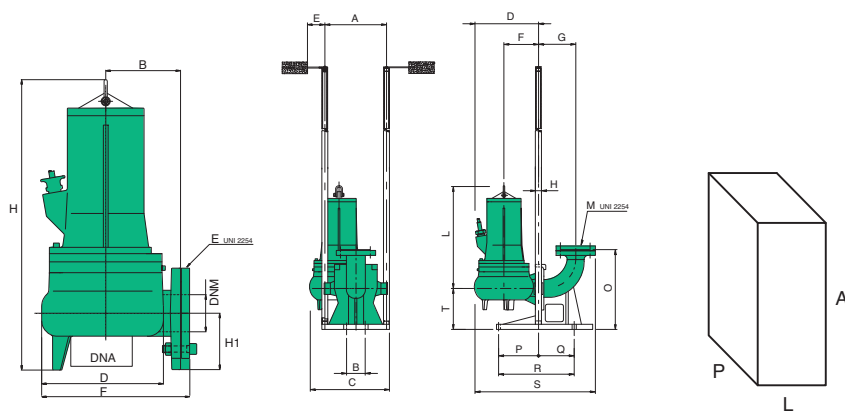

TIPO TYPE	DIMENSIONI [mm] DIMENSIONS [mm]								IMBALLO [mm] PACKING [mm]			PESO WEIGHT [kg]
	B	D	E	F	H	H1	DNA	DNM	A	L	P	
DV 30/300T4	160	270	Ø 3"	295	620	125	80	80	670	320	350	70
DV 30/300T2	160	270	Ø 3"	295	620	125	80	80	670	320	350	68
DV 30/400T2	160	270	Ø 3"	295	620	125	80	80	670	320	350	70
DV 30/550T2	160	270	Ø 3"	295	620	125	80	80	670	320	350	72
DV 30/750T2	160	270	Ø 3"	295	620	125	80	80	670	320	350	76

+ KIT	A	B	C	D	E	F	G	H	L	M	O	P	Q	R	S	T
	353	110	460	415	300	175	180	Ø 2"	480	Ø 3"	375	240	150	390	615	220

“Green Box”



STAZIONI DI SOLLEVAMENTO AUTOMATICHE PER ACQUE DI SCARICO

Le stazioni di sollevamento automatiche “Green Box” sono state progettate per raccogliere e rilanciare acque di scarico da utenze domestiche e civili posizionate sotto il livello delle condotte fognarie. Esse possono raccogliere liquidi luridi, chimicamente non aggressivi per i materiali della pompa, anche con piccoli corpi solidi in sospensione. Temperatura max. 35 °C .

CARATTERISTICHE COSTRUTTIVE

- Serbatoio in polietilene ad alta densità
- Coperchio di chiusura calpestabile a tenuta stagna
- Collettori di entrata da DN 110,
- Collettori di mandata in acciaio zincato da 2”
- Tubo di sfiato in PVC DN 50
- Versione singola pompa da l. 200
- Versione doppia pompa da l. 600
- Portata: fino a 70 m³/h
- Prevalenza: fino a 15 m
- Potenza: da 0.59 kW fino a 2 X1.47 kW

STATIONS DE RELÈVEMENT AUTOMATIQUES D'EAUX USÉES

Les stations de relèvement automatiques “Green Box ”ont été conçues pour recueillir et relancer les eaux usées domestiques et civiles placées sous le niveau des conduites d'égout. Elles peuvent recueillir des liquides sales, chimiquement non agressifs pour les matériaux de la pompe, même avec de petits corps solides en suspension. Température max. 35 °C .

CARACTERISTIQUES DE CONSTRUCTION

- Cuve en polyéthylène haute densité.
- Couvercle hermétique vous pouvez bafouer
- Collecteurs d'entrée de DN 110,
- Sortie avec tuyau fileté en acier galvanisé de 2 ”
- Tuyau de ventilation de PVC DN 50
- Version pompe seule l. 200
- Version pompe double l. 600
- Plage d'utilisation jusqu'à 70 m³/h.
- Hauteur manométrique jusqu'à 90 m.
- Puissance: de 0,59 kW à 2 X1.47 kW

AUTOMATIC WASTEWATER LIFTING STATION

The automatic wastewater lifting station “Green Box” have been designed to collect and pump up wastewater when the domestic or civil drain systems are lower than the sewage level. The station may collect dirty liquids chemically not aggressive for the pumps' material also with small suspended solids.

Temperature not higher than 35 °C,

TECHNICAL FEATURES

- Tank in High Density Polyethylene
- Tank cover walkable with watertight closing
- Inlet Collectors DN 110,
- Outlet Collectors in galvanized steel 2”
- Vent tube in PVC DN 50
- Single Version pump tank capacity l. 200
- Double Version pump tank capacity l. 600
- Capacity: up to 70 m³/h
- Total head: up to 15 m
- Power: from 0.59 kW up to 2 X 1.47 kW

ESTACIONES DE ELEVACIÓN AUTOMÁTICA PARA AGUAS RESIDUALES

Las estaciones de elevación automáticas “Green Box ”han sido proyectadas para captar y relanzar aguas residuales domésticas y civiles situadas bajo el nivel del alcantarillado. Pueden captar líquidos sucios y fecales, químicamente no agresivos para los materiales de la bomba, incluso con pequeños cuerpos sólidos en suspensión. Temperatura max. 35 °C .

CARACTERÍSTICAS DE CONSTRUCCIÓN

- Tanque de polietileno de alta densidad
- Tapa sellada y transitable
- Colectores de entrada da DN 110,
- Tramo de tubo galvanizado2” en salida para cada bomba
- Tubo de ventilación de PVC DN 50
- Version en única bomba, tanque de l. 200
- Versión con dos bombas, tanque de l. 600
- Caudal: hasta 70 m³/h
- Elevación máxima: 15 m
- Potencia: de 0.59 kW hasta 2 X 1.47 kW



Utilizzi Green box - Green Box application

N° UtENZE Outlets	Modello pompa Pump model
N° 3	Green Box+ Venezia 925
N° 5	Green Box + Dvx 120
N° 7	Green Box + Dvx 150
N° 9	Green Box + Dvx 200
N° 6	Green Box + 2xVenezia 925
N° 10	Green Box + 2xDvx 120
N° 15	Green Box + 2xDvx 120
N° 20	Green Box + 2xDvx 150
N° 25	Green Box + 2xDvx 150
N° 30	Green Box + 2xDvx 200
N° 35	Green Box + 2xDvx 200
N° 40	Green Box + 2xDvx 200

* calcolato su utenze con portate medie di 120 l. 1' con prevalenza 2 m.

* calculated on users with medium capacities of 120 l. 1' with water head 2 m.

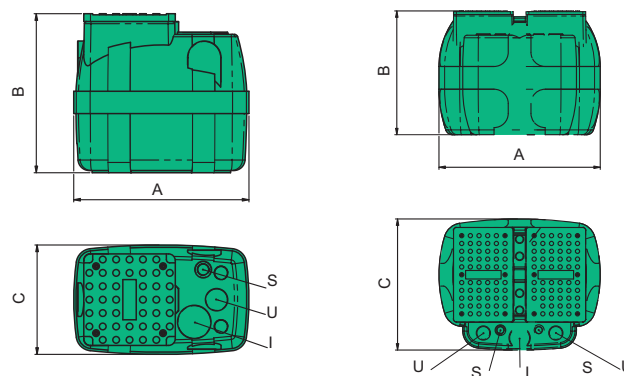

TIPO TYPE	DIMENSIONI [mm] DIMENSIONS [mm]						PESO WEIGHT
	A	B	C	I	U	S	
GREENBOX	780	700	480	Ø 110	2"	Ø 50	300
GREENBOX	920	850	1090	Ø 110	2"	Ø 50	600

* peso pompa esclusa / * weight without pump

"YACHT"



POMPE DA SENTINA

La pompa da sentina della serie "YACHT" è realizzata in speciale materiale sintetico (polipropilene anti-idrocarburi e anti-urto). Velocità e facilità nell'installazione, nell'utilizzo e nella manutenzione.

Basso consumo e ottime portate.

La "YACHT" viene fornita di base per fissaggio con 1 m di cavo elettrico.

CARATTERISTICHE COSTRUTTIVE

- Corpo pompa e girante: Tecnopolimero
- Albero pompa e viti: acciaio inox Aisi 316
- Tenuta: a labbro in NBR

MOTORE

Motore a corrente continua di 12V o 24V, non adatto per servizio continuo.

POMPE DE CALE

La pompe de cale de la série "YACHT" est réalisée dans une matière synthétique spéciale (polypropylène anti-hydrocarbures et antichoc).

Vitesse et facilité dans l'installation, dans l'utilisation et dans la maintenance.

Basse consommation et excellentes plages d'utilisation.

La "YACHT" est fournie avec une base pour fixation avec 1 m de fil électrique.

CARACTERISTIQUES DE CONSTRUCTION

- Corps de pompe et Turbine: Technopolymère
- Abre de pompe et vis: acier inox Aisi 316
- Garniture: à lèvres en élastomère

MOTOR

Moteur de CC 12V DC ou 24V, pas adapté pour un service continu.

BILGE PUMPS

The bilge pumps of the series "YACHT" are entirely manufactured in special crash, rust and hydrocarbons proof polypropylene.

Very easy to be cleaned and installed, this pump is supplied with 1 meter cable, fastening bottom cover and instruction manual for correct use.

TECHNICAL FEATURES

- Pump body and impeller: Techno-polymer
- Pump shaft & screws: stainless steel Aisi 316
- Seal: NBR lip seal

MOTOR

DC motor 12V or 24, not suitable for continuous duty.

BOMBAS DE SENTINA

La bomba de sentina de la serie "YACHT" ha sido realizada con un especial material sintético (polipropileno anti-hidrocarburos y anti-choque).

Velocidad y facilidad de instalación, de uso y de mantención.

Bajo consumo y óptima capacidad.

La "YACHT" viene dotada de base para su fijación con 1 m de cable eléctrico.

CARACTERISTICAS DE CONSTRUCCIÓN

- Cuerpo de bomba y rodete: De tecnopolímero
- Eje de la bomba y tornillo: de acero Inox Aisi 316
- Sello: anillo de cierre en NBR

MOTOR

Motor de corriente continua de 12V ó 24V, No apto para servicio continuo.

$\text{min}^{-1} \sim 2900$

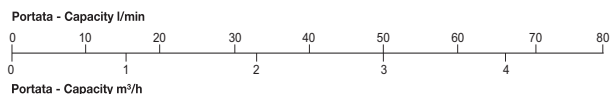
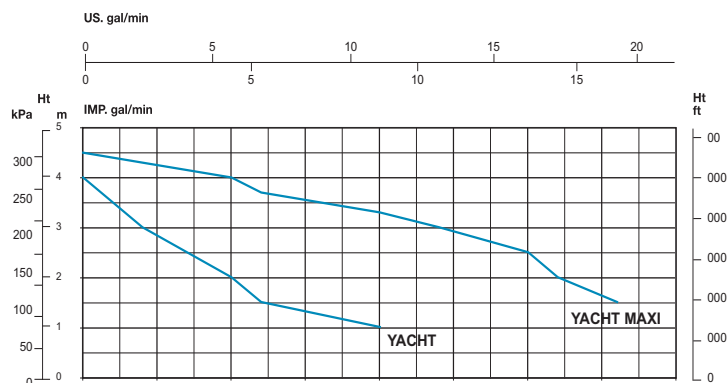

TIPO TYPE	Volt Volt	Potenza assorbita Input power	Giri RPM	Corrente assorbita Input current	Portata - Capacity											
					Q [m³/h]	0	0,6	1,5	1,8	3	3,6	4,5	4,8	5,4	5,7	
				[A]	Q [l/min]	0	10	25	30	50	60	75	80	90	95	
					Prevalenza (m C.A.) Total head (m W.C.)											
	[V]	[W]	[min-1]		H [m]	4	3	2	1,5	1	0,8	0,5				
YACHT 12	12	50	10	4,2		4	3	2	1,5	1	0,8	0,5				
YACHT 24	24	50	5	2		4	3	2	1,5	1	0,8	0,5				
YACHT MAXI 12	12	120	20	10		4,5	4,3	4	3,7	3,3	3	2,5	2	1,5	1	
YACHT MAXI 24	24	120	10	5	4,5	4,3	4	3,7	3,3	3	2,5	2	1,5	1		

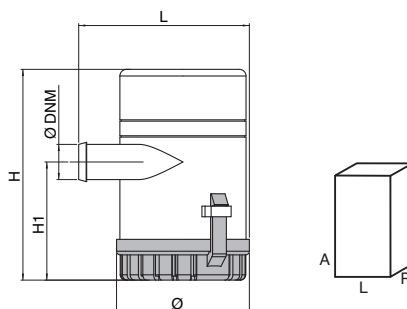

TIPO TYPE	DIMENSIONI [mm] DIMENSIONS [mm]					IMBALLO [mm] PACKING [mm]			PESO WEIGHT [kg]
	Ø	H	H1	L	DNM	A	L	P	
YACHT 12V	78	125	90	128	29	180	135	135	0,93
YACHT 24V	78	125	90	128	29	180	135	135	0,93
YACHT MAXI 12 V	96	160	90	128	29	240	135	135	1,83
YACHT MAXI 24V	96	160	90	128	29	240	135	135	1,83

"Verti J Sub"



NOMENCLATURA PARTI DI RICAMBIO
SPARE PARTS LIST
NOMENCLATURE PIECES DE RECHANGE
NOMENCLATURA REPUESTOS

Praticità d'uso
Alte prestazioni
Risparmio energetico

Easy installation
High performance
Energy saving

Facilità d'emploi
Performances élevées
Économie d'énergie

Practicidad de uso
Altas prestaciones
Ahorro energético

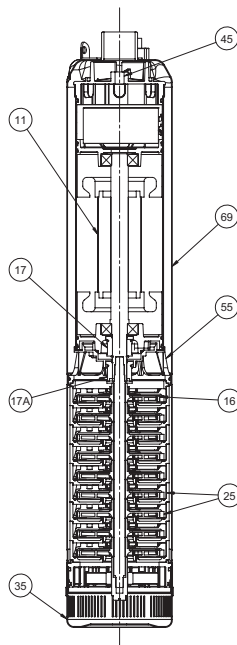

- 11** Albero con rotore – Pump shaft + rotor
Arbre + rotor – Eje rotor
- 16** Girante – Impeller
Turbine – Impulsor
- 17** Tenuta a labbro in NBR – Lip ring in NBR
Garniture à lèvres en élastomère – Anillo de cierre en NBR
- 17A** Tenuta meccanica inferiore – Mechanical seal
Garniture mécanique inférieur – Cierre mecánico inferior
- 25** Diffusore – Diffuser
Diffuseur – Difusor
- 35** Base pompa – Pump base
Base pompe – Base bomba
- 45** Coperchio corpo – Cover
Couvercle corps – Tapa cuerpo
- 55** Supporto tenuta – Seal support
Support garniture – Soporte cierre
- 69** Camicia – Cover
Chemise – Camisa

ELETTROPOMPE MONOBLOCCO SOMMERGIBILI MULTISTADIO

Le elettropompe centrifughe monoblocco verticali multistadio della serie Vertì J Sub sono state progettate utilizzando i più moderni e sofisticati sistemi di progettazione d'ingegneria e design industriale. Esse sono state studiate per pompare liquidi puliti, senza parti abrasive, senza corpi solidi in sospensione, non esplosivi o aggressivi per i materiali della pompa.

Temperatura max. del liquido fino a 35 °C per uso domestico (CEI EN 60335-2-41) o 60 °C per altri usi.

La silenziosità assoluta d'esercizio ne permette l'installazione sia in ambienti interni che esterni immerse in vasche e/o serbatoi. L'utilizzo di materiali resistenti alla corrosione, il particolare disegno dei diffusori e giranti ne rendono adatto l'impiego anche in leggera presenza di sabbia nell'acqua,

CARATTERISTICHE COSTRUTTIVE

- Corpo pompa: acciaio inox Aisi 304
- Corpo motore: acciaio inox Aisi 304
- Albero pompa: acciaio inox Aisi 420 F
- Diffusori: Tecnopolimero
- Giranti: Tecnopolimero
- Tenuta meccanica lato pompa: carbone - ceramica
- Tenuta lato motore: a labbro in NBR
- Connettore estraibile a tenuta stagna con innesto rapido
- 10 m cavo di alimentazione tipo H07RN-F e spina Schuko.

MOTORE

- Motore ad induzione a due poli, riavvolgibile, refrigerato dal liquido pompato, con protezione IP68, isolamento classe F.
- Alimentazione monofase con motoprotettore incorporato e condensatore permanentemente inserito.
- Alimentazione trifase con protezione obbligatoria a cura dell'utente.
- Servizio continuo.

ÉLECTROPOMPES MONOBLOC SUBMERSIBLES MULTISTADIO

Les électropompes centrifuges monobloc verticales multistadio de la série Vertì J Sub ont été conçues en utilisant les plus modernes et les plus sophistiqués systèmes de projet d'ingénierie et de design industriel. Elles ont été étudiées pour pomper des liquides propres, sans parties abrasives, sans corps liquides en suspension, non explosifs ou agressifs pour les matériaux de la pompe. Température max. du liquide jusqu'à 35 °C pour utilisation domestique (CEI EN 60335-2-41) o 60 °C pour d'autres utilisations.

Le silence de fonctionnement absolu en permet l'installation aussi en intérieur qu'en extérieur immergées dans des cuves et/ou réservoirs.

L'utilisation de matériaux résistants à la corrosion, la conception particulière des diffuseurs et des roues en rendent l'emploi adapté même en légère présence de sable dans l'eau,

CARACTERISTIQUES DE CONSTRUCTION

- Corps de pompe : acier inox Aisi 304
- Corps de moteur: acier inox Aisi 304
- Abre de pompe: acier inox Aisi 420 F
- Diffuseurs: Technopolymère
- Turbine: Technopolymère
- Garniture mécanique partie pompe: Carbone dur - Céramique
- Garniture partie moteur: à lèvres en élastomère
- Connecteur étanche extractible • avec attache rapide
- 10 m Câble d'alimentation H07RN-F.

MOTOR

- Moteur à induction à deux pôles rebobinable, refroidi par le liquide pompé, protection IP68, classe d'isolation F.
- Le modèles monophasé son avec protection thermique et condensateur connecté en permanence
- Pour les modèles triphasés, la protection est à la charge de l'utilisateur. A recommandé l'équipement conformément à la réglementation
- Service S1

SUMERSIBLE MONOBLOC MULTISTAGE ELECTRIC PUMPS

The vertical monobloc multistage electric pumps of the series Vertì J Sub are designed with the most advanced and sophisticated engineering and industrial design systems. They have been studied to pump clean liquids, without abrasives and suspended solids, non-explosive or aggressive for the pump's materials.

Liquid temperature not higher than 35 °C for domestic use (CEI EN 60335-2-41) or 60 °C for other use.

The extreme noiselessness permit the internal or external installation, immersed in to a storage tank or basin. The use of corrosion-proof materials along with the particular impeller & diffuser design make them suitable for environments with a slight presence of sand in the water.

TECHNICAL FEATURES

- Pump body: stainless steel Aisi 304
- Motor body: stainless steel Aisi 304
- Pump shaft: stainless steel Aisi 420 F
- Diffusers: Techno-polymer
- Impeller: Techno-polymer
- Pump's side mechanical seal: carbon-ceramics
- Motor's side seal: lip ring in NBR
- Quick cable coupling watertight connector
- 10 m H07RN-F feeding cable whit Schuko plug.

MOTOR

- Two poles induction rewindable motor with protection IP 68, class F insulation.
- Single-phase feeding with incorporated motor protector and capacitor permanently connected.
- Three-phase feeding with compulsory protection to be provided by the user.
- Continuous duty.

ELECTROBOMBAS MONOBLOQUE SUMERGIBLES MULTIETAPA

Las electrobombas centrifugas monobloque verticales multietapa de la serie Vertì J Sub han sido realizadas utilizando los más modernos y sofisticados sistemas de proyectación de ingeniería y de diseño industrial. Han sido estudiadas para bombear líquidos limpios, sin partes abrasivas, sin cuerpos sólidos en suspensión y que no sean explosivos o agresivos para los materiales de la bomba.

Temperatura max. del líquido hasta 35 °C para uso doméstico (CEI EN 60335-2-41) o 60 °C para otros usos.

Su funcionamiento absolutamente silencioso permite su instalación tanto en ambientes interiores como exteriores sumergidas en tanques y/o depósitos.

El empleo de materiales resistentes a la corrosión, el especial diseño de los difusores y de los impulsores permiten su uso incluso en ligera presencia de arena en el agua.

CARACTERISTICAS DE CONSTRUCCIÓN

- Cuerpo de bomba: de acero Inox AISI304
- Cuerpo de motor: de acero Inox AISI304
- Eje de la bomba: de acero Inox Aisi 420 F
- Difusores: De tecnopolímero
- Rodetes: De tecnopolímero
- Cierre mecánico lado bombas: De cerámica y grafito
- Cierre lado motor: anillo de cierre en NBR
- Conector extraíble impermeable con cierre rápido
- Cable de alimentación :10 m H07RN-F

MOTOR

- Motor a induction de dos poles rebobinables, enfriado por el líquido bombeado, protección IP68, aislamiento de clase F.
- Para los modelos monofásicos, protección térmica y condensador incorporado
- Para los modelos trifásicos de la protección se encarga el usuario y el equipo recomendado de acuerdo con las normas
- Funcionamiento S1

50 Hz

TIPO TYPE Monofase Single-phase	Potenza nominale Nominal power		Potenza assorbita Input power [W]	Condensatore Capacitor 450 V max [µF]	Corrente assorbita Input current [A] 1~ 230 V	Portata - Capacity								
	kW	HP				Prevalenza (m C.A.) Total head (m W.C.)								
			Q [m ³ /h]	0	1,2	2,4	3	3,6	4,8	6	7,2			
Verti J Sub 83 M	0,59	0,8	600	14	2,6	H [m]	29,3	24,7	19,5	16,6	13,7	7,3		
Verti J Sub 103 M	0,74	1	820	16	3,8		39,2	33,2	26,2	22,4	18,3	9,4		
Verti J Sub 86 M	0,59	0,8	690	14	3		34,1	30,5	26,5	24,4	22,2	17,6	12,7	7,4

a) ~ Monofase 230 V

60 Hz

TIPO TYPE Monofase Single-phase	Potenza nominale Nominal power		Potenza assorbita Input power [W]	Condensatore Capacitor 450 V max [µF]	Corrente assorbita Input current [A] 1~ 230 V	Portata - Capacity								
	kW	HP				Prevalenza (m C.A.) Total head (m W.C.)								
			Q [m ³ /h]	0	1,2	2,4	3	3,6	4,8	6	7,2			
Verti J Sub 103 M	0,74	1	930	31,5	8,3	H [m]	38,4	32,1	26,1	23,2	20,4	14,9	9,7	4,7

a) ~ Monofase 230 V

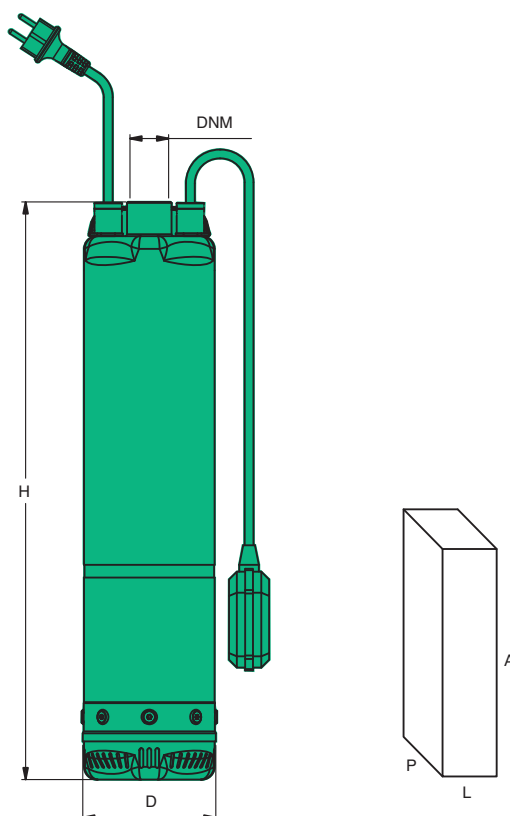

TIPO TYPE	DIMENSIONI [mm] DIMENSIONS [mm]			IMBALLO [mm] PACKING [mm]			PESO WEIGHT [kg]
	H	D	DNM	A	L	P	
Verti J Sub 83	591	136	1"	900	240	220	10
Verti J Sub 103	640	136	1"	900	240	220	11
Verti J Sub 86	591	136	1"	900	240	220	10,6

min⁻¹ ~ 2900

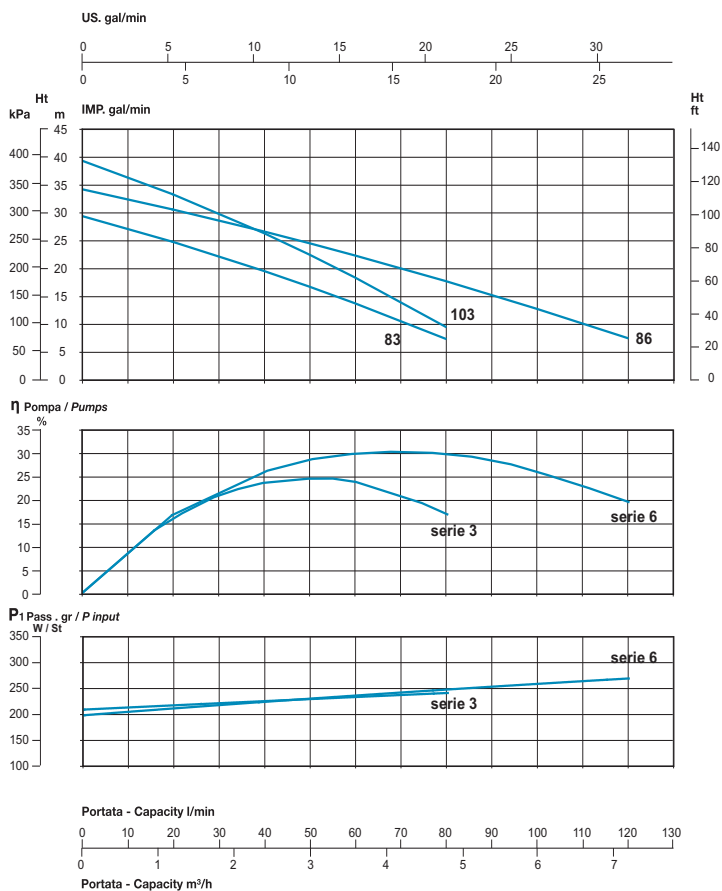

min⁻¹ ~ 3400

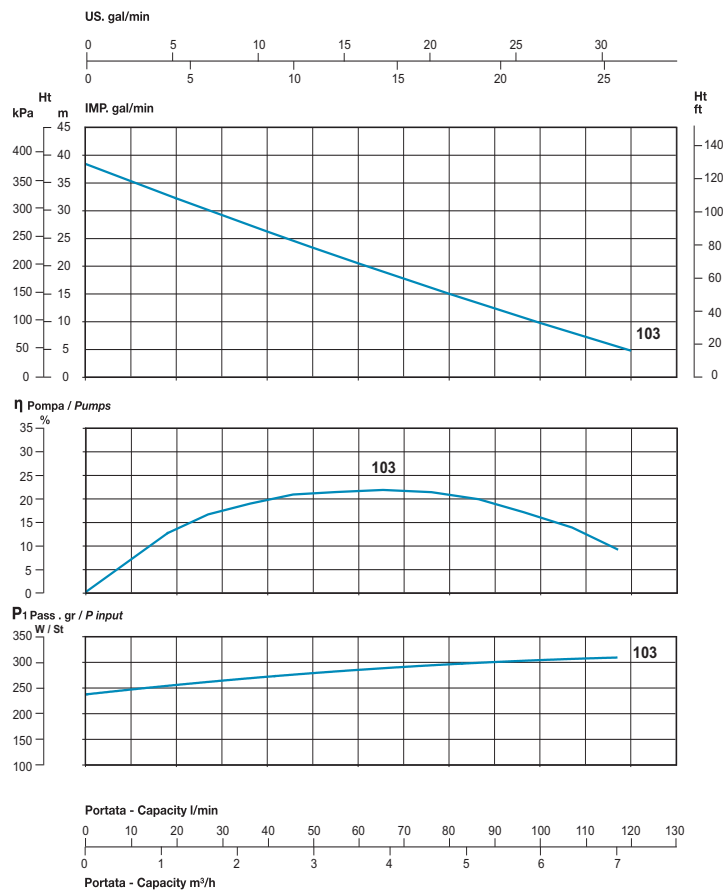

"Verti Sub"



NOMENCLATURA PARTI DI RICAMBIO
SPARE PARTS LIST
NOMENCLATURE PIECES DE RECHANGE
NOMENCLATURA REPUESTOS

Praticità d'uso
Alte prestazioni
Risparmio energetico
Connettore estraibile a tenuta stagna con innesto rapido

Easy installation
High performance
Energy saving
Quick cable coupling watertight connector

Facilité d'emploi
Performances élevées
Économie d'énergie
Connecteur extractible étanche avec accrochage rapide

Practicidad de uso
Altas prestaciones
Ahorro energético
Conector extraíble estanco de acoplamiento rápido

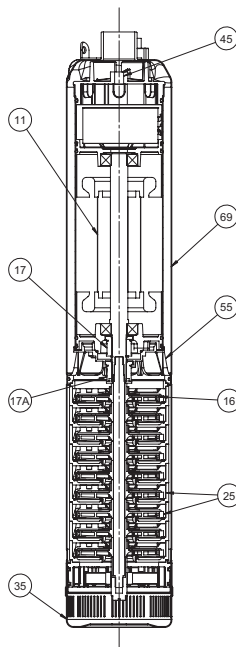

- 11** Albero con rotore – Pump shaft + rotor
Arbre + rotor – Eje rotor
- 16** Girante – Impeller
Turbine – Impulsor
- 17** Tenuta meccanica – Mechanical seal
Garniture mécanique – Cierre mecánico
- 17A** Tenuta meccanica inferiore – Mechanical seal
Garniture mécanique inférieur – Cierre mecánico inferior
- 25** Diffusore – Diffuser
Diffuseur – Difusor
- 35** Base pompa – Pump base
Base pompe – Base bomba
- 45** Coperchio corpo – Cover
Couvercle corps – Tapa cuerpo
- 55** Supporto tenuta – Seal support
Support garniture – Soporte cierre
- 69** Camicia – Cover
Chemise – Camisa

TOP RANGE

Electric pumps

ELETTROPOMPE SOMMERGIBILI MONOBLOCCO MULTISTADIO

Le elettropompe sommergibili monoblocco multistadio della serie Verti Sub, sono state progettate utilizzando i più moderni e sofisticati sistemi di progettazione d'ingegneria e design industriale. Le Verti Sub sono state studiate per pompare liquidi puliti, senza parti abrasive, senza parti in sospensione, non esplosivi o aggressivi per i materiali della pompa. Temperatura max. del liquido fino a 35 °C per uso domestico (CEI EN 60335-2-41) o 60 °C per altri usi. La silenziosità assoluta d'esercizio ne permette l'installazione sia in ambienti interni che esterni immerse in vasche e/o serbatoi. L'utilizzo di materiali resistenti alla corrosione, il particolare disegno dei diffusori e giranti ne rendono adatto l'impiego anche in leggera presenza di sabbia nell'acqua. Massima immersione 15 m.

CARATTERISTICHE COSTRUTTIVE

- Corpo pompa: acciaio inox Aisi 304
- Diffusori: Tecnopolimero
- Girante: Tecnopolimero
- Corpo motore: acciaio inox Aisi 304
- Albero pompa: acciaio inox Aisi 304
- Tenuta meccanica lato pompa: carburo di silicio-allumina
- Tenuta meccanica lato motore: grafite - allumina
- Connettore estraibile a tenuta stagna con innesto rapido
- 20 m cavo alimentazione tipo H07RN-F.

MOTORE

- Motore ad induzione a due poli, riavvolgibile, refrigerato dal liquido pompato, con protezione IP68, isolamento classe F.
- Alimentazione monofase con motoprotettore incorporato e condensatore permanentemente inserito.
- Alimentazione trifase con protezione obbligatoria a cura dell'utente.
- Servizio continuo.

A RICHIESTA:

- Versione automatica con galleggiante flottante (AUT).

ÉLECTROPOMPES SUBMERSIBLES MONOBLOC MULTISTADIO

Les électropompes submersibles monobloc multistadio de la série Verti Sub, ont été conçues en utilisant les plus modernes et les plus sophistiqués systèmes de projet d'ingénierie et de design industriel. Les Verti Sub ont été étudiées pour pomper des liquides propres, sans parties abrasives, sans parties en suspension, non explosifs ou agressifs pour les matériaux de la pompe. Température max. du liquide jusqu'à 35 °C pour utilisation domestique (CEI EN 60335-2-41) ou 60 °C pour d'autres utilisations. Le silence de fonctionnement absolu en permet l'installation aussi en intérieur qu'en extérieur immergées dans des cuves et/ou réservoirs. L'utilisation de matériaux résistants à la corrosion, la conception particulière des diffuseurs et des roues en rendent l'emploi adapté même en légère présence de sable dans l'eau. Immersion maximale 15 m.

CARACTERISTIQUES DE CONSTRUCTION

- Corps de pompe : acier inox Aisi 304
- Diffuseurs: Techonopolymère
- Turbine: Techonopolymère
- Corps de moteur: acier inox Aisi 304
- Abre de pompe: acier inox Aisi 304
- Garniture mécanique partie pompe: partie pompe: carbure de silicium-alumina
- Garniture mécanique partie moteur: en graphite - alumina
- Connecteur étanche extractible avec attache rapide
- 20 m Câble d'alimentation H07RN-F.

MOTOR

- Moteur à induction à deux pôles rebobinable, refroidi par le liquide pompé, protection IP68, classe d'isolation F.
- Le modèles monophasé son avec protection thermique et condensateur connecté en permanence
- Pour les modèles triphasés, la protection est à la charge de l'utilisateur. A recommandé l'équipement conformément à la réglementation
- Service S1

SUR DEMANDE:

- Version Monophasée avec flotteur automatique

VERTICAL MONOBLOC MULTISTAGE ELECTRIC PUMPS

The vertical monobloc multistage electric pumps of the series Verti Sub are designed with the most advanced and sophisticated engineering and industrial design systems. The Verti Sub have been studied to pump clean liquids, without abrasives and suspended solids, non-explosive or aggressive for the pump's materials, with liquid temperature not higher than 35 °C for domestic use (CEI EN 60335-2-41) or 60 °C for other use. The extreme noiselessness permit the internal or external installation, immersed in to a storage tank or basin. The use of corrosion-proof materials along with the particular impeller & diffuser design make them suitable for environments with a slight presence of sand in the water. Max. immersion 15 m.

TECHNICAL FEATURES

- Pump body: stainless steel Aisi 304
- Diffusers: Techno-polymer
- Impeller: Techno-polymer
- Motor body: stainless steel Aisi 304
- Pump shaft: stainless steel Aisi 304
- Pump's side mechanical seal: silicon carbide- alumina
- Motor's side mechanical seal: graphite-alumina
- Quick cable coupling watertight connector
- 20 m H07RN-F feeding cable.

MOTOR

- Two poles induction rewindable motor cooled by the pumped liquid, with protection IP 68, class F. insulation.
- Single-phase feeding with incorporated motor protector and capacitor permanently connected.
- The compulsory three-phase feeding protection is to be supplied by the user.
- Continuous duty.

ON REQUEST:

- Single-phase automatic version with float switch (AUT).

ELECTROBOMBAS SUMERGIBLES MONOBLOQUE MULTITAPAS

Las electrobombas sumergibles monobloque multietapa de la serie Verti Sub, han sido realizadas utilizando los más modernos y sofisticados sistemas de proyectación de ingeniería y de diseño industrial. Las Verti Sub an sido estudiadas para bombear líquidos limpios, sin partes abrasivas, sin cuerpos sólidos en suspensión y que no sean explosivos o agresivos para los materiales de la bomba. Temperatura max. del líquido hasta 35 °C para uso doméstico (CEI EN 60335-2-41) o 60 °C para otros usos. Su funcionamiento absolutamente silencioso permite su instalación tanto en ambientes interiores como exteriores sumergidas en tanques y/o depósitos. El empleo de materiales resistentes a la corrosión, el especial diseño de los difusores y de los impulsores permiten su uso incluso en ligera presencia de arena en el agua. Máxima inmersión 15 m.

CARACTERISTICAS DE CONSTRUCCIÓN

- Cuerpo de bomba: de acero Inox AISI304
- Difusores: De tecnopolímero
- Rodetes: De tecnopolímero
- Cuerpo de motor: de acero Inox AISI304
- Eje de la bomba: de acero Inox AISI304
- Cierre mecánico lado bombas: carburo de silicio y alúmina
- Cierre mecánico lado motor: en grafito y alúmina
- Conector extraíble impermeable con cierre rápido
- Cable de alimentación :20 m H07RN-F

MOTOR

- Motor a induction de dos polos rebobinables, enfriado por el líquido bombeado, protección IP68, aislamiento de clase F.
- Para los modelos monofásicos, protección térmica y condensador incorporado
- Para los modelos trifásicos de la protección se encarga el usuario y el equipo recomendado de acuerdo con las normas
- funcionamiento S1

BAJO DEMANDA:

- Versión Monofásico con interruptor de nivel automático (AUT)

min⁻¹ ~ 2900

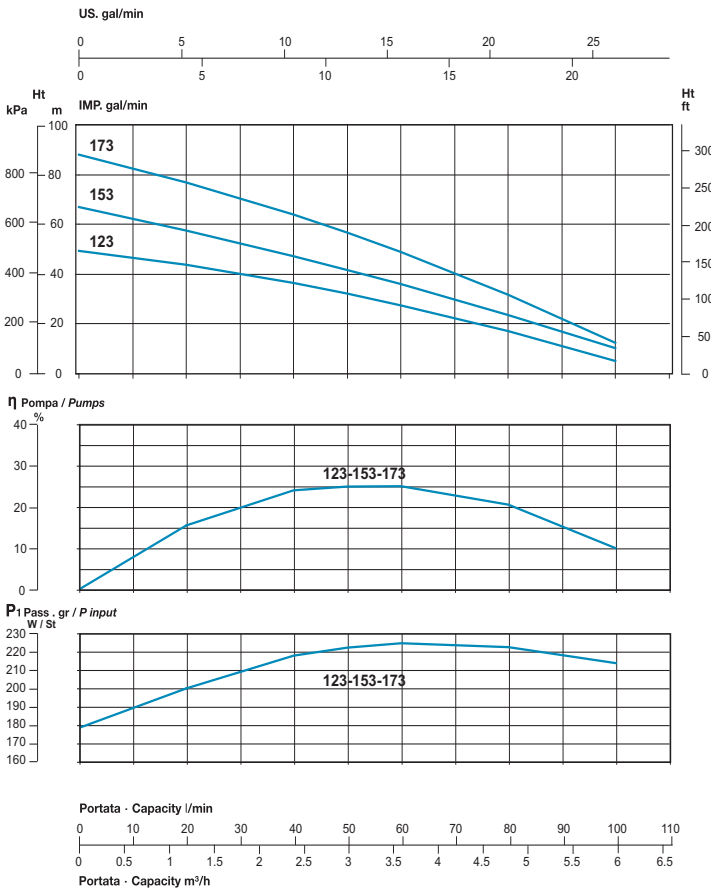

min⁻¹ ~ 3400

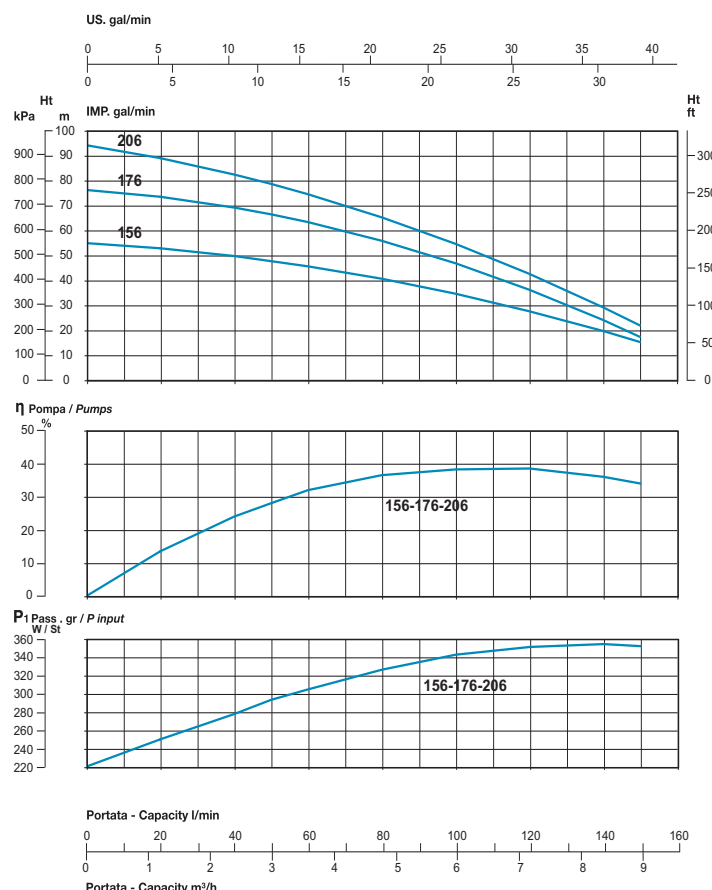
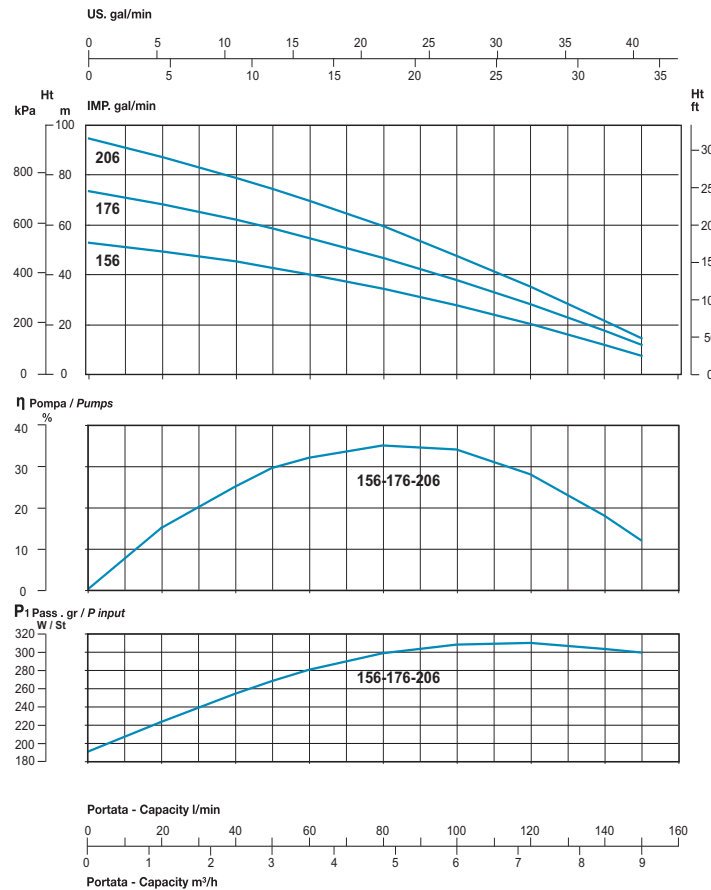
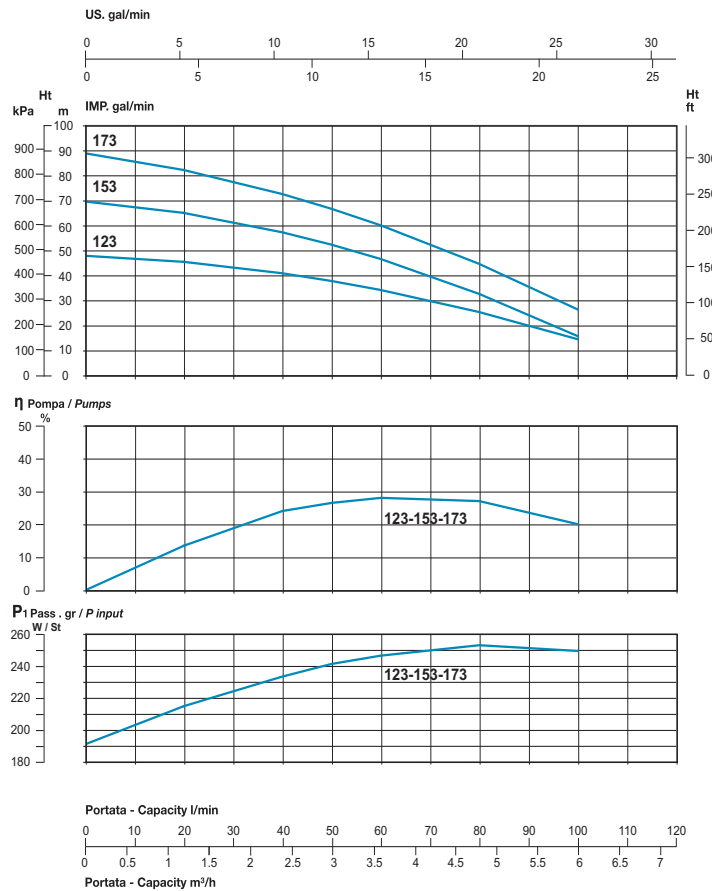

min⁻¹ ~ 2900

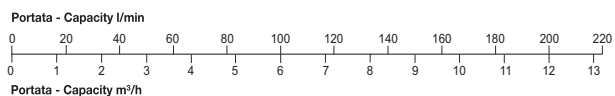
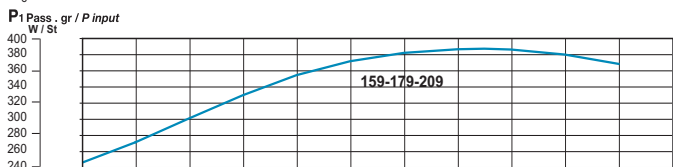
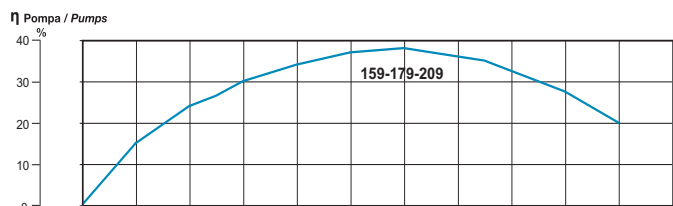
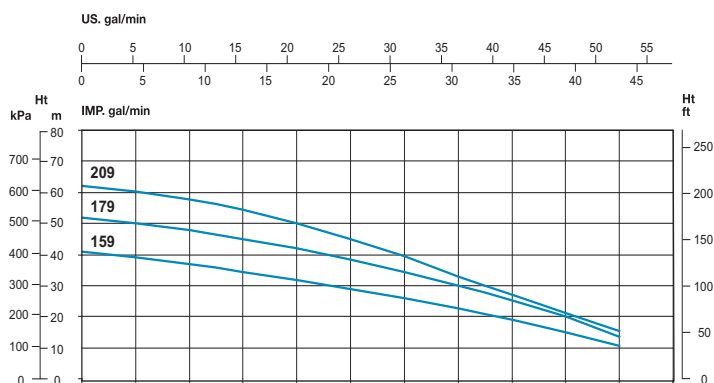

min⁻¹ ~ 3400

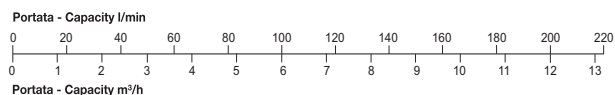
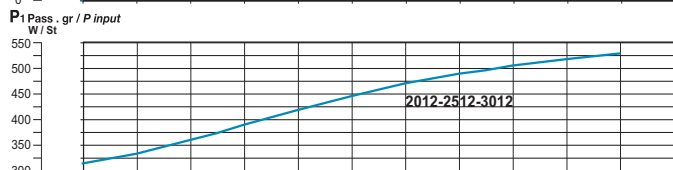
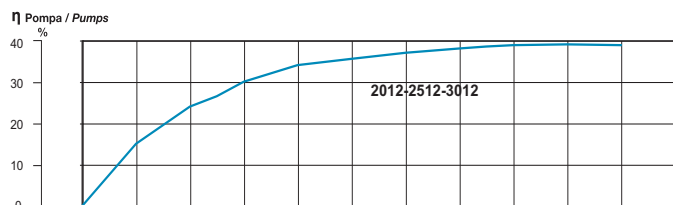
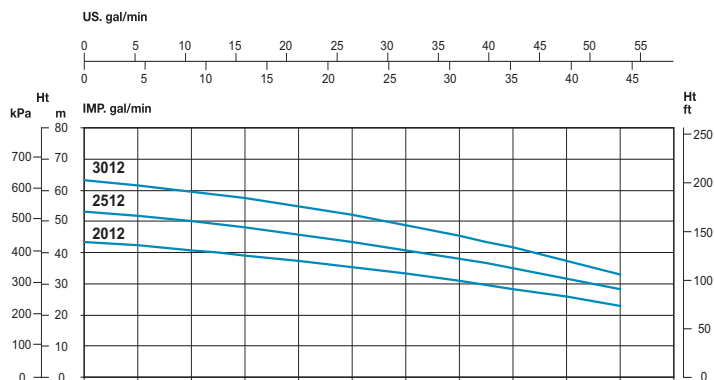
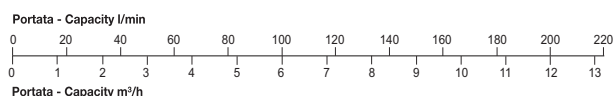
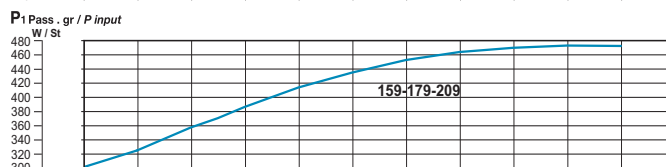
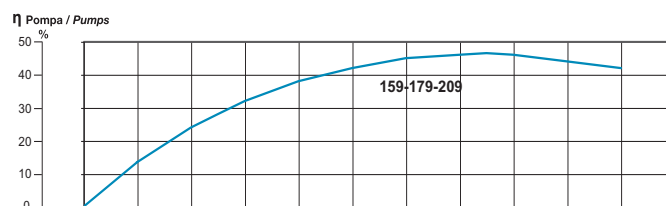
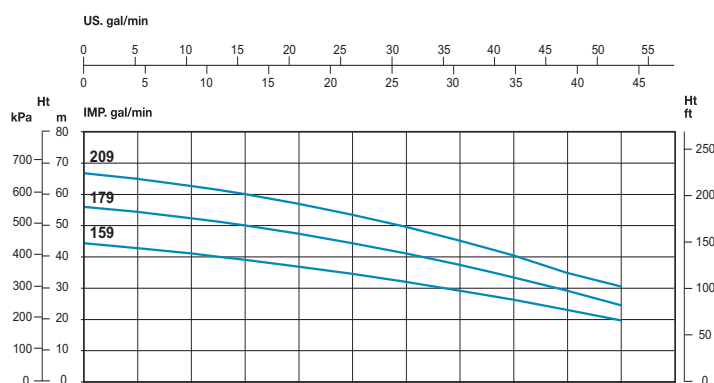

50 Hz

TIPO TYPE		Potenza nominale Nominal power		Potenza assorbita Input power [W]		Condensatore Capacitor 450 V max	Corrente assorbita Input current [A]		Portata - Capacity															
Monofase Single-phase	Trifase Three-phase	kW	HP	a	b	[μ F]	1~230V	3~400V	Q [m ³ /h]	0	1.2	2.4	3	3.6	4.8	6	7.2	8.4	9	9.6	10.8	12		
a	b								Q [l/1']	0	20	40	50	60	80	100	120	140	150	160	180	200		
Prevalenza (m C.A.) Total head (m W.C.)																								
Verti SUB 123 M		0.88	1.2	1180	-	30	5.2	-	H [m]	49,4	43,7	36,5	32,3	27,7	17,3	5,3								
Verti SUB 153 M		1.1	1.5	1530	-	31.5	6.8	-		66,8	57,6	47,3	41,8	36,0	23,7	10,4								
Verti SUB 173 M	Verti SUB 173 T	1.47	2	1990	1890	36	9.2	4.1		88,0	76,9	63,9	56,6	48,8	31,7	12,6								
Verti SUB 156 M		1.1	1.5	1640	-	31.5	7.3	-		52,9	49,4	45,2	42,8	40,1	34,3	27,7	20,3	12,1	7,7					
Verti SUB 176 M	Verti SUB 176 T	1.47	2	2170	2090	40	9.8	3.9		73,7	68,3	62,0	58,5	54,8	46,8	37,9	28,2	17,7	12,1					
Verti SUB 206 M	Verti SUB 206 T	1.85	2.5	2610	2610	50	11.7	4.8		94,6	87,4	79,1	74,5	69,7	59,3	47,8	35,2	21,6	14,4					
Verti SUB 159 M		1.1	1.5	1580	-	31.5	7.1	-		40,9	39,0	36,8	35,7	34,4	31,8	29,0	25,9	22,5	20,8	19,0	14,8	10,5		
Verti SUB 179 M	Verti SUB 179 T	1.47	2	1950	1950	40	8.9	3.9		51,8	50,0	47,8	46,5	45,1	42,0	38,5	34,5	30,1	27,7	25,2	20,0	13,4		
Verti SUB 209 M	Verti SUB 209 T	1.85	2.5	2340	2240	50	10.6	4.3		62,0	60,3	57,7	56,1	54,3	50,1	45,1	39,3	32,8	30,0	27,0	21,0	15,3		
Verti SUB 2012 M	Verti SUB 2012 T	1,47	2	2350	2200	40	10,5	4,0		43,5	42,2	40,7	39,9	39,1	37,3	35,3	33,2	30,9	29,7	28,4	25,7	22,9		
Verti SUB 2512 M	Verti SUB 2512 T	1,85	2,5	2650	2800	50	11,7	5,2		53,2	51,7	50,0	49,0	48,0	45,8	43,5	40,8	38,0	36,5	34,9	31,7	28,2		
Verti SUB 3012 M	Verti SUB 3012 T	2,2	3	3100	3280	55	13,6	6		63,3	61,6	59,6	58,6	57,4	54,8	52,0	48,8	45,3	43,5	41,5	37,5	33,1		

a) ~ Monofase 230 V

b) ~ Trifase 400 V

60 Hz

TIPO TYPE		Potenza nominale Nominal power		Potenza assorbita Input power [W]		Condensatore Capacitor 450 V max	Corrente assorbita Input current [A]		Portata - Capacity															
Monofase Single-phase	Trifase Three-phase	kW	HP	a	b	[μ F]	1~220V	3~380V	Q [m ³ /h]	0	1.2	2.4	3	3.6	4.8	6	7.2	8.4	9	9.6	10.8	12		
a	b								Q [l/1']	0	20	40	50	60	80	100	120	140	150	160	180	200		
Prevalenza (m C.A.) Total head (m W.C.)																								
Verti SUB 123 M		0,88	1,2	1290	-	25	6,0	-	H [m]	47,7	45,3	40,7	37,6	34,0	25,2	14,3								
Verti SUB 153 M		1,1	1,5	1750	-	30	8,0	-		69,4	64,8	57,1	52,1	46,4	32,5	15,6								
Verti SUB 173 M	Verti SUB 173 T	1,47	2	2600	1540	40	10,4	3,5		88,7	82,0	72,4	66,5	59,9	44,5	26,3								
Verti SUB 156 M		1,1	1,5	1800	-	31,5	8,3	-		54,8	52,7	49,6	47,6	45,5	40,5	34,5	27,5	19,6	15,2					
Verti SUB 176 M	Verti SUB 176 T	1,47	2	2600	1650	40	11,8	3,7		76,1	73,4	69,0	66,3	63,2	55,7	46,7	36,1	24,0	17,3					
Verti SUB 206 M	Verti SUB 206 T	1,85	2,5	3000	2000	50	13,9	4,5		94,0	88,8	82,3	78,5	74,4	65,1	54,5	42,5	29,1	21,9					
Verti SUB 159 M		1,1	1,5	2000	-	30	9,4	-		44,1	42,5	40,8	39,8	38,8	36,6	34,3	31,7	28,9	27,5	26,0	22,8	19,4		
Verti SUB 179 M	Verti SUB 179 T	1,47	2	2400	1600	36	11,1	3,5		55,7	54,1	52,1	51,0	49,8	47,1	44,1	40,8	37,2	35,2	33,2	28,9	24,3		
Verti SUB 209 M	Verti SUB 209 T	1,85	2,5	2650	1900	40	12,3	4,3		66,5	64,7	62,4	61,2	59,8	56,7	53,2	49,3	44,9	42,6	40,2	34,6	30,3		

a) ~ Monofase 230 V

b) ~ Trifase 400 V

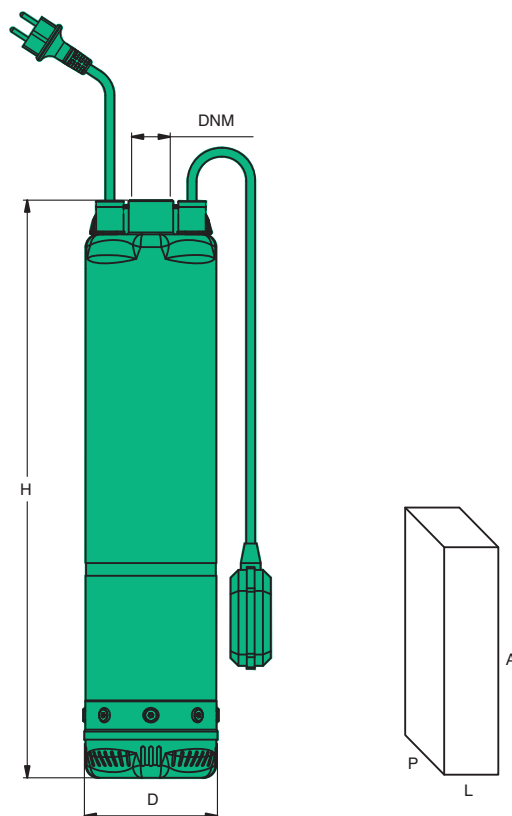



TIPO TYPE	DIMENSIONI [mm] DIMENSIONS [mm]			IMBALLO [mm] PACKING [mm]			PESO WEIGHT [kg]
	H	D	DNM	A	L	P	
Vertì Sub 123 Aut	591	136	1"1/4	900	240	220	16.5
Vertì Sub 153 Aut	640	136	1"1/4	900	240	220	18
Vertì Sub 173 Aut	749	136	1"1/4	900	240	220	19.5
Vertì Sub 173 T	749	136	1"1/4	900	240	220	19
Vertì Sub 156 Aut	591	136	1"1/4	900	240	220	17
Vertì Sub 176 Aut	640	136	1"1/4	900	240	220	18
Vertì Sub 176 T	640	136	1"1/4	900	240	220	17.5
Vertì Sub 206 Aut	749	136	1"1/4	900	240	220	19.5
Vertì Sub 206 T	749	136	1"1/4	900	240	220	19
Vertì Sub 159 Aut	640	136	1"1/4	900	240	220	18
Vertì Sub 179 Aut	664	136	1"1/4	900	240	220	19
Vertì Sub 179 T	664	136	1"1/4	900	240	220	18.5
Vertì Sub 209 Aut	763	136	1"1/4	900	240	220	20
Vertì Sub 209 T	763	136	1"1/4	900	240	220	19.5
Vertì Sub 2012 M	640	136	1"1/4	800	190	240	24
Vertì Sub 2012 T	640	136	1"1/4	800	190	240	24
Vertì Sub 2512 M	664	136	1"1/4	800	190	240	22
Vertì Sub 2512 T	664	136	1"1/4	800	190	240	21
Vertì Sub 3012 M	763	136	1"1/4	900	190	240	25
Vertì Sub 3012 T	763	136	1"1/4	900	190	240	24

"LESTA"



NOMENCLATURA PARTI DI RICAMBIO
SPARE PARTS LIST
NOMENCLATURE PIECES DE RECHANGE
NOMENCLATURA REPUESTOS

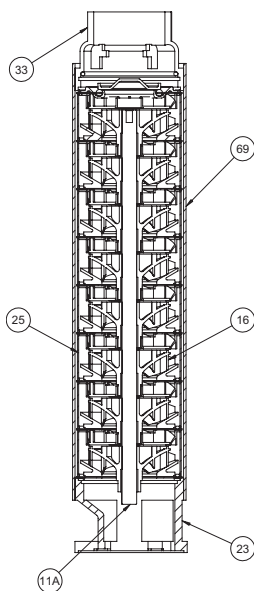

- 11A** Albero pompa – Pump shaft
Arbre pompe – Eje de la bomba
- 16** Girante – Impeller
Turbine – Impulsor
- 23** Corpo flangia aspirante – Suction flange body
Corp bride aspirant – Cuerpo brida entrega
- 25** Diffusore – Diffuser
Diffuseur – Difusor
- 33** Flangia mandata – Outlet flange
Bride envoyée – brida entrega
- 69** Camicia – Cover
Chemise – Camisa

ELETTROPOMPE SOMMERSE DA 4" IN ACCIAIO INOX

Le pompe sommerse da 4" della serie "Lesta" sono state progettate per essere installate in pozzi di almeno da Ø 4" (100 mm) e per pompare acque pulite o con leggera presenza di sabbia (180 g/m² max.), senza corpi solidi in sospensione, non esplosivi o aggressivi per i materiali della pompa. Temperatura max. del liquido no a 35 °C per uso domestico (CEI EN 60335-2-41) o 40 °C per altri usi. Grazie alle innovative giranti ottanti, oltre a ridurre i problemi di bloccaggio determinato dalla presenza di sabbia, riducono notevolmente la spinta assiale, dando quindi maggior durata al motore, esse poi sono protette da una particolare costruzione della valvola di non ritorno che essendo integrata nella testata preserva i giranti ed i di usori dal peso della colonna d'acqua e da eventuali colpi d'ariete.

CARATTERISTICHE COSTRUTTIVE

- Testata pompa: in microfusione di acciaio inox Aisi 304
- Flangia di aspirazione: in microfusione di acciaio inox Aisi 304
- Valvola di non ritorno: in acciaio inox Aisi 304
- Albero pompa: in acciaio inox Aisi 304
- Camicia esterna e filtro: in acciaio inox Aisi 304
- Diffusori: Tecnopolimero
- Giranti: Tecnopolimero

MOTORE

- Flangia a norme NEMA
- Estensione albero in acciaio inox Aisi 303
- Camicia esterna acciaio inox Aisi 304
- Supporti in ghisa al nichel ricoperti in acciaio inox Aisi 304
- Tenuta meccanica carbone-ceramica con labirinto parasabbia
- 20 m cavo d'alimentazione a 4 li
- Connettore estraibile a tenuta stagna con innesto rapido
- Massima immersione 135 m.
- Quadro elettromeccanico monofase con condensatore di marcia, protezione termica.

ÉLECTROPOMPES IMMERGÉES DE 4" EN ACIER INOX

Les pompes immergées de 4" de la série "Lesta" ont été conçues pour être installées dans des puits d'au moins de Ø 4" (100mm) et pour pomper des eaux propres ou avec une légère présence de sable (180 g/m² max.), sans corps liquides en suspension, non explosifs ou agressifs pour les matériaux de la pompe. Température max. du liquide jusqu'à 35 °C pour utilisation domestique (CEI EN 60335-2-41) ou 40 °C pour d'autres utilisations. Grâce aux innovantes roues ottantes, en plus de réduire les problèmes de blocage déterminés par la présence de sable, elles réduisent notablement la poussée axiale, donnant ainsi une plus grande durée au moteur, elles sont ensuite protégées par une construction particulière du clapet de non-retour qui étant intégré dans la tête préserve les roues et les diaphragmes du poids de la colonne d'eau et d'éventuels coups de bélier.

CARACTERISTIQUES DE CONSTRUCTION

- Tête de pompe: moulage de précision d'acier inox Aisi 304
- Bride d'accouplement: moulage de précision d'acier inox Aisi 304
- Clapet anti-retour: acier inox Aisi 304
- Abre de pompe: acier inox Aisi 304
- Chemise extérieures et le filtre: acier inox Aisi 304
- Diffuseurs: Technopolymère
- Turbine: Technopolymère

MOTOR

- Bride a norme NEMA
- Extension arbre en acier inox AISI 303
- Tuyau externe en acier inox AISI 304
- Support en fonte au nickel avec revêtement en acier inox AISI 304
- Garniture mécanique en carbone céramique avec labirynthe de protection de sable
- 20 m câble d'alimentation à 4 fils
- Connecteur étanche avec attache rapide
- Immersion maximale de 35 m.
- Coffret électromécanique monophasé avec le condensateur de marché et protection thermique.

SUBMERSIBLE ELECTRIC PUMPS FOR 4" WELLS IN STAINLESS STEEL

The 4" submersible pumps of the series "Lesta" have been designed to be installed in 4" wells (100mm) and to pump clean water or water with the slight presence of sand (180 g/m² max.), without suspended solids.

Temperatures not higher than 35 °C for domestic use (CEI EN 60335-2-41) or 40 °C for other use.

Thanks to the innovative floating impellers, besides that the blockage problems caused by the presence of sand are reduced, also the axial thrust is remarkably reduced granting a longer life to the motor. Further the particular construction of the non-return valve integrated in the upper head protects the impellers and di users from the weight of the column and eventual water hammers.

TECHNICAL FEATURES

- Upper head of the pump: in precision-cast stainless steel Aisi 304
- Suction ange: in precision-cast stainless steel Aisi 304
- Check valve: in stainless steel Aisi 304
- Pump shaft: in stainless steel Aisi 304
- Outside sleeve: in stainless steel Aisi 304
- Diffusers: Techno-polymer
- Impellers: Techno-polymer

MOTOR

- Flange at NEMA standards
- Shaft extension in stainless steel Aisi 303
- Outside shell in stainless steel Aisi 304
- Brackets in nickel coated cast iron
- Mechanical seal in graphite-ceramic with sand ghter labyrinth
- Quick cable coupling watertight connector
- 20 m 4 wire feeding cable
- Max immersion 35 m.
- Electromechanical single-phase control panel with capacitor of run, thermal protection.

ELECTROBOMBAS SUMERGIDAS DE 4" EN ACERO INOX

Las bombas sumergidas de 4" de la serie "Lesta" han sido proyectadas para su instalación en pozos de al menos Ø 4" (100mm) y para el bombeo de aguas limpias o con ligera presencia de arena (180 g/m² max.), sin cuerpos sólidos en suspensión, que no sean explosivos ni agresivos para los materiales de la bomba.

Temperatura max. del líquido hasta 35 °C para uso doméstico (CEI EN 60335-2-41) o 40 °C para otros usos.

Gracias a los innovadores impulsores otantes, además de reducir los problemas de bloqueo causado por la presencia de arena, moderan notablemente el empuje axial, dando por tanto una mayor duración al motor; estos además están protegidos por una construcción especial de la válvula de anti-retorno que al estar integrada en el cabezal preserva los impulsores y los difusores del peso de la columna de agua y de eventuales golpes de ariete.

CARACTERISTICAS DE CONSTRUCCIÓN

- Cabeza de la bomba: fundición en acero inoxidable AISI 304
- Brida de conexión: de fundición de acero inoxidable Aisi 304
- Válvula de retención: De acero Inox AISI 304
- Eje de la bomba: de acero Inox AISI 304
- Camisa y filtro de aspiración: En acero Inox AISI 304
- Difusores: De tecnopolímero
- Rodetes: De tecnopolímero

MOTOR

- Brida a norme NEMA, de fundición gris tattada al níquel
- Borne de eje en acero inoxidable Aisi 303
- Camisa externa en acero inoxidable AISI 304
- Cierre mecánico: De cerámica y gra to con protector anti-arena
- Cable de alimentación: 20 m.
- Conector extraíble impermeable con cierre rápido
- Máxima inmersión 35 m.
- Cuadro eletricos monofásico con condensator de marcia e protection termica.

50 Hz

TIPO TYPE	Alimentaz. Feeding	Potenza nominale Nominal power		Corrente assorbita [A] Input current [A]		cos φ (PF.)	η (Eff.) [%]	Condensatore Capacitor [μF]	S.F. S.F.	Velocità Speed [RPM]	Portata - Capacity					
		[kW]	[HP]	I _N	I _{START}						Prevalenza (m C.A.) Total head (m W.C.)					
											Q [m ³ /h]	0	1,2	1,8	2,4	3
LESTA 50 - 05	Monofase	0,37	0,5	3,4	10,2	0,94	53	20	1,6	2860	H [m]	47	42	36	29	19
LESTA 50 - 08	Single phase	0,55	0,75	4,6	13,6	0,94	58	25	1,5	2855	H [m]	67	60	52	41	27

a) ~ Monofase 230 V

min⁻¹ ~ 2900

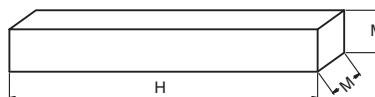
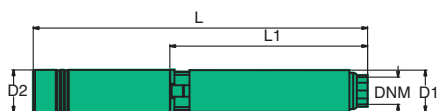
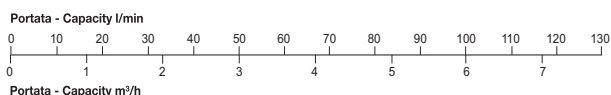
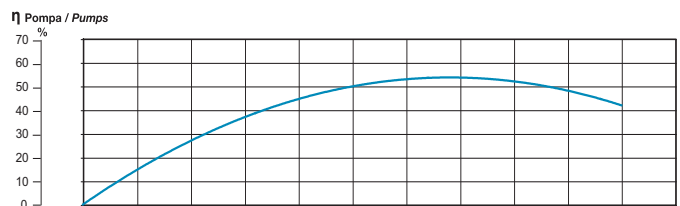
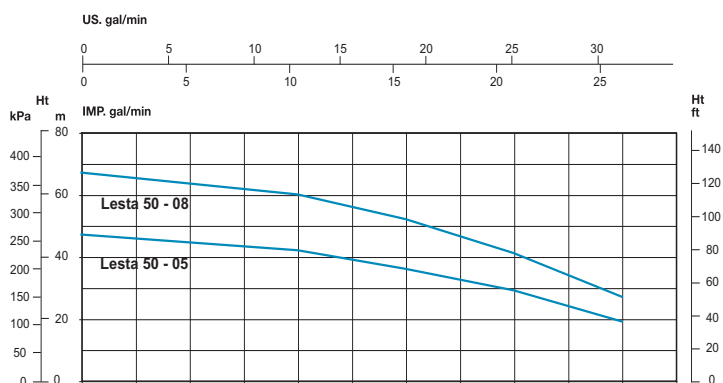

TIPO TYPE	DIMENSIONI [mm] DIMENSIONS [mm]				IMBALLO [mm] PACKING [mm]		PESO [kg] WEIGHT [kg]	
	L1	L	D1	DNM	H	M	Pompa	Totale
LESTA 50 - 05	290	615	98	1" 1/4	665	160	2,9	9,9
LESTA 50 - 08	332	657	98	1" 1/4	707	160	3,5	11,1

"SL"



NOMENCLATURA PARTI DI RICAMBIO
SPARE PARTS LIST
NOMENCLATURE PIECES DE RECHANGE
NOMENCLATURA REPUESTOS

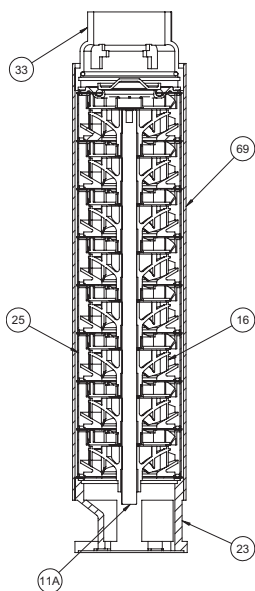

- 11A** Albero pompa – Pump shaft
Arbre pompe – Eje de la bomba
- 16** Girante – Impeller
Turbine – Impulsor
- 23** Corpo flangia aspirante – Suction flange body
Corp bride aspirant – Cuerpo brida entrega
- 25** Diffusore – Diffuser
Diffuseur – Difusor
- 33** Flangia mandata – Outlet flange
Bride envoyée – brida entrega
- 69** Camicia – Cover
Chemise – Camisa

POMPE SOMMERSE DA 4" IN ACCIAIO INOX

Le pompe sommerse da 4" della serie "SL" sono state progettate per essere installate in pozzi di almeno da Ø 4" (100mm) e per pompare acque pulite o con leggera presenza di sabbia (180 g/m³ max.), senza corpi solidi in sospensione, non esplosivi o aggressivi per i materiali della pompa.

Temperatura max. del liquido fino a 35 °C per uso domestico (CEI EN 60335-2-41) o 40 °C per altri usi.

Grazie alle innovative giranti flottanti, oltre a ridurre i problemi di bloccaggio determinato dalla presenza di sabbia, riducono notevolmente la spinta assiale, dando quindi maggior durata al motore, esse poi sono protette da una particolare costruzione della valvola di non ritorno che essendo integrata nella testata preserva i giranti ed i diffusori dal peso della colonna d'acqua e da eventuali colpi d'ariete.

CARATTERISTICHE COSTRUTTIVE

- Flangia di aspirazione: in microfusione di acciaio inox Aisi 304
- Valvola di non ritorno: in acciaio inox Aisi 304
- Albero pompa: in acciaio inox Aisi 304
- Camicia esterna e filtro: in acciaio inox Aisi 304
- Diffusori: Tecnopolimero
- Giranti: Tecnopolimero

POMPES IMMERGÉES DE 4" EN ACIER INOX

Les pompes immergées de 4" de la série "SL" ont été conçues pour être installées dans des puits d'au moins de Ø 4" (100mm) et pour pomper des eaux propres ou avec une légère présence de sable (180 g/m³ max.), sans corps liquides en suspension, non explosifs ou agressifs pour les matériaux de la pompe.

Température max. du liquide jusqu'à 35 °C pour utilisation domestique (CEI EN 60335-2-41) ou 40 °C pour d'autres utilisations.

Grâce aux innovantes roues flottantes, en plus de réduire les problèmes de blocage déterminés par la présence de sable, elles réduisent notablement la poussée axiale, donnant ainsi une plus grande durée au moteur, elles sont ensuite protégées par une construction particulière du clapet de non-retour qui étant intégré dans la tête préserve les roues et les diffuseurs du poids de la colonne d'eau et d'éventuels coups de bélier.

CARACTERISTIQUES DE CONSTRUCTION

- Tête de pompe: moulage de précision d'acier inox Aisi 304
- bride d'accouplement: moulage de précision d'acier inox Aisi 304
- Clapet anti-retour: acier inox Aisi 304
- Abre de pompe: acier inox Aisi 304
- Chemise extérieures et le filtre: acier inox Aisi 304
- Diffuseurs: Techonopolymère
- Turbine: Techonopolymère

SUBMERSIBLE PUMPS FOR 4" WELLS IN STAINLESS STEEL

The 4" submersible pumps of the series "SL" have been designed to be installed in 4" wells (100mm) and to pump clean water or water with the slight presence of sand (180 g/m³ max.), without suspended solids.

Temperatures not higher than 35 °C for domestic use (CEI EN 60335-2-41) or 40 °C for other use.

Thanks to the innovative floating impellers, besides that the blockage problems caused by the presence of sand are reduced, also the axial thrust is remarkably reduced granting a longer life to the motor. Further the particular construction of the non-return valve integrated in the upper head protects the impellers and diffusers from the weight of the column and eventual water hammers.

TECHNICAL FEATURES

- Upper head of the pump: in precision-cast stainless steel Aisi 304
- Suction flange: in precision-cast stainless steel Aisi 304
- Check valve: in stainless steel Aisi 304
- Pump shaft: in stainless steel Aisi 304
- Outside sleeve: in stainless steel Aisi 304
- Diffusers: Techno-polymer
- Impellers: Techno-polymer

BOMBAS SUMERGIDAS DE 4" EN ACERO INOX

Las bombas sumergidas de 4" de la serie "SL" han sido proyectadas para su instalación en pozos de al menos Ø 4" (100mm) y para el bombeo de aguas limpias o con ligera presencia de arena (180 g/m³ max.), sin cuerpos sólidos en suspensión, que no sean explosivos ni agresivos para los materiales de la bomba.

Temperatura max. del líquido hasta 35 °C para uso doméstico (CEI EN 60335-2-41) o 40 °C para otros usos.

Gracias a los innovadores impulsores flotantes, además de reducir los problemas de bloqueo causado por la presencia de arena, moderan notablemente el empuje axial, dando por tanto una mayor duración al motor; estos además están protegidos por una construcción especial de la válvula de anti-retorno que al estar integrada en el cabezal preserva los impulsores y los difusores del peso de la columna de agua y de eventuales golpes de ariete.

CARACTERÍSTICAS DE CONSTRUCCIÓN

- Cabeza de la bomba: fundición en acero inoxidable AISI 304
- Brida de conexión: de fundición de acero inoxidable Aisi 304
- Válvula de retención: De acero Inox AISI 304
- Eje de la bomba: de acero Inox AISI304
- Camisa y filtro de aspiración: En acero Inox AISI 304
- Difusores: De tecnopolímero
- Rodetes: De tecnopolímero

50 Hz

TIPO TYPE	Potenza nominale Nominal power		Portata - Capacity																			
	a	kW	HP	Q [m ³ /h]		Q [l/1']																
0				1,2	1,8	2,4	3	5,4	6	7,2	8,4	9,6	10,8	13,2	15,6	16,8	18	20,4				
			0	20	30	40	50	90	100	120	140	160	180	220	260	280	300	340				
			Prevalenza (m C.A.) Total head (m W.C.)																			
SL 50 - 05	0,37	0,5	47	42	36	29	19															
SL 50 - 08	0,55	0,75	67	60	52	41	27															
SL 50 - 10	0,74	1	93	83	73	57	37															
SL 50 - 15	1,1	1,5	133	119	104	82	53															
SL 50 - 20	1,47	2	187	167	146	115	74															
SL 70 - 08	0,55	0,75	54	51	49	43	38															
SL 70 - 10	0,74	1	72	68	64	58	49															
SL 70 - 15	1,1	1,5	106	101	95	83	70															
SL 70 - 20	1,47	2	142	135	127	115	100															
SL 70 - 30	2,2	3	206	200	187	165	138															
SL 100 - 08	0,55	0,75	46		42	40	31	13														
SL 100 - 10	0,74	1	59		54	51	41	20														
SL 100 - 15	1,1	1,5	93		86	81	66	33														
SL 100 - 20	1,47	2	120		111	105	85	42														
SL 100 - 30	2,2	3	175		161	152	123	61														
SL 100 - 40	3	4	231		212	202	166	87														
SL 100 - 55	4	5,5	285		280	248	198	100														
SL 140 - 10	0,74	1	42				36	28	25	19												
SL 140 - 15	1,1	1,5	62				53	41	38	29												
SL 140 - 20	1,47	2	90				77	63	59	46												
SL 140 - 30	2,2	3	126				107	86	80	62												
SL 140 - 40	3	4	169				145	115	107	84												
SL 140 - 55	4	5,5	208				178	143	132	103												
SL 140 - 75	5,5	7,5	302				257	209	193	151												
SL 200 - 20	1,47	2	52						46	43	39	35	29									
SL 200 - 30	2,2	3	82						71	66	59	50	40									
SL 200 - 40	3	4	108						94	87	79	70	58									
SL 200 - 55	4	5,5	132						111	103	93	82	68									
SL 200 - 75	5,5	7,5	148						127	118	108	95	79									
SL 200 - 100	7,5	10	202						172	160	143	125	105									
SL 400 - 30	2,2	3	51											33	29	27	24	20				
SL 400 - 40	3	4	70											47	41	38	34	28				
SL 400 - 55	4	5,5	81											55	48	45	41	34				
SL 400 - 75	5,5	7,5	97											66	58	54	50	41				
SL 400 - 100	7,5	10	125											84	74	70	65	54				

60 Hz

TIPO TYPE	Potenza nominale Nominal power		Portata - Capacity																			
	a	kW	HP	Q [m ³ /h]	0	1,5	1,8	2,4	3	3,6	4,8	5,4	6	7,2	8,4	9,6	10,8	15,6	18	20,4		
				Q [l/s]	0	25	30	40	50	60	80	90	100	120	140	160	180	260	300	340		
				Prevalenza (m C.A.) Total head (m W.C.)																		
			H [m]		67	58	55	49	39	27												
SL 50 - 05	0,37	0,5		67	58	55	49	39	27													
SL 50 - 08	0,55	0,75		96	85	81	71	58	40													
SL 50 - 10	0,75	1		115	102	98	85	68	47													
SL 50 - 15	1,1	1,5		168	152	147	128	102	70													
SL 50 - 20	1,5	2		195	177	168	146	118	82													
SL 70 - 08	0,55	0,75		67		61	57	50	41													
SL 70 - 10	0,75	1		94		85	78	69	58													
SL 70 - 15	1,1	1,5		116		109	102	91	78													
SL 70 - 20	1,5	2		165		154	143	128	109													
SL 70 - 30	2,2	3		204		193	180	162	139													
SL 100 - 08	0,55	0,75		56					45	37	30	23										
SL 100 - 10	0,75	1		75					61	49	41	32										
SL 100 - 15	1,1	1,5		104					84	68	58	46										
SL 100 - 20	1,5	2		133					108	88	75	61										
SL 100 - 30	2,2	3		181					146	119	102	81										
SL 100 - 40	3	4		238					192	158	136	110										
SL 140 - 10	0,74	1		52					42	38	33	27	18									
SL 140 - 15	1,1	1,5		70					55	50	43	35	24									
SL 140 - 20	1,47	2		91					72	65	58	48	32									
SL 140 - 30	2,2	3		128					102	94	83	70	51									
SL 140 - 40	3	4		160					129	117	104	89	67									
SL 140 - 55	4	5,5		220					177	162	148	125	95									
SL 140 - 75	5,5	7,5		308					246	225	200	167	122									
SL 200 - 20	1,47	2		55								45	42	38	35							
SL 200 - 30	2,2	3		74								63	60	56	50							
SL 200 - 40	3	4		100								83	78	73	66							
SL 200 - 55	4	5,5		139								118	113	105	97							
SL 200 - 75	5,5	7,5		194								162	154	145	134							
SL 400 - 30	2,2	3		45															32	29	27	
SL 400 - 40	3	4		61															42	39	35	
SL 400 - 55	4	5,5		88															60	54	48	
SL 400 - 75	5,5	7,5		126															85	76	67	

min⁻¹ ~ 2900

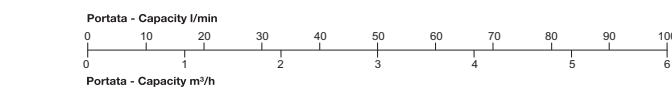
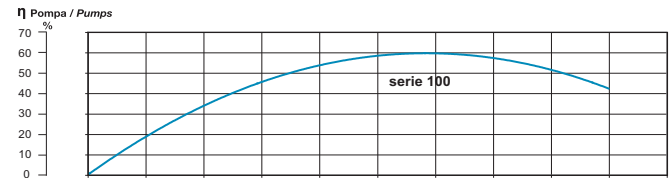
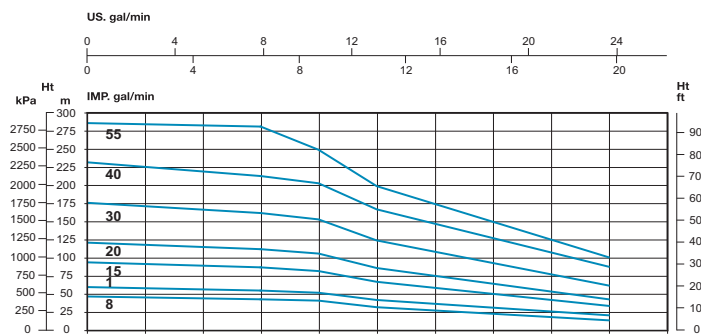
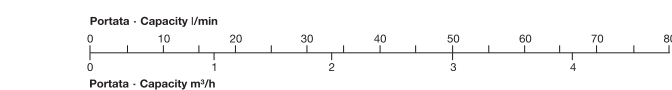
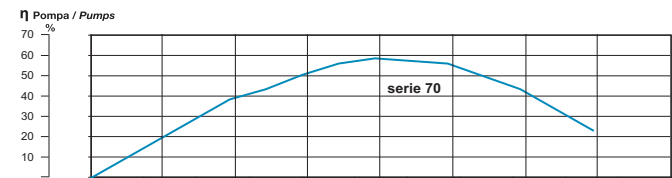
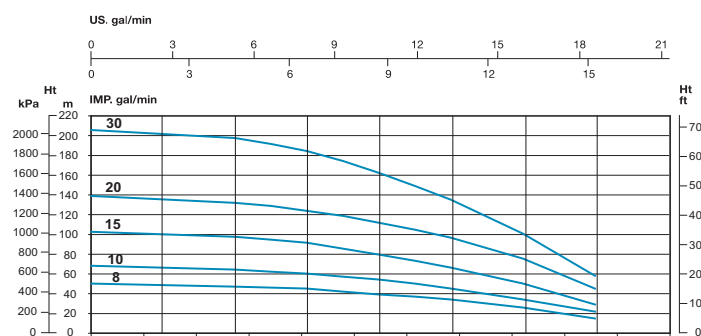
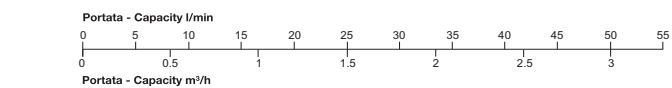
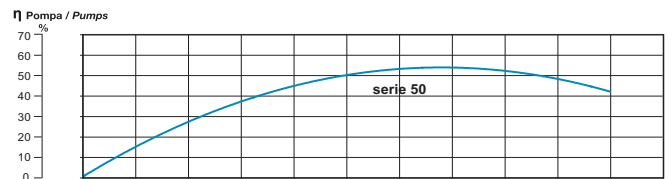
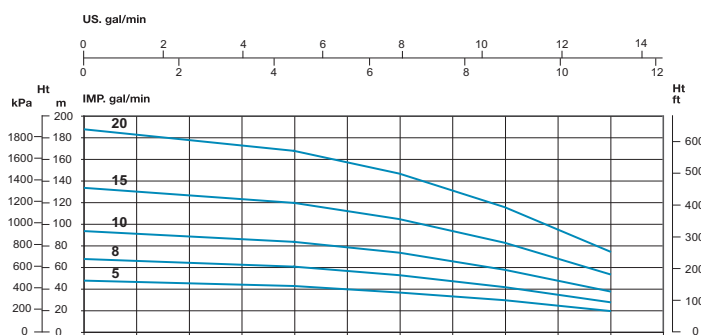

min⁻¹ ~ 3400

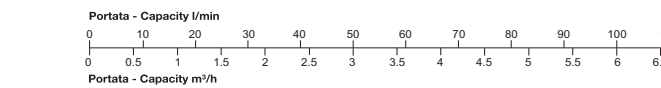
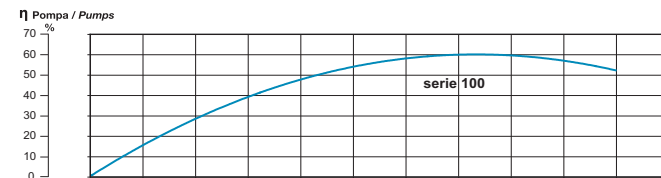
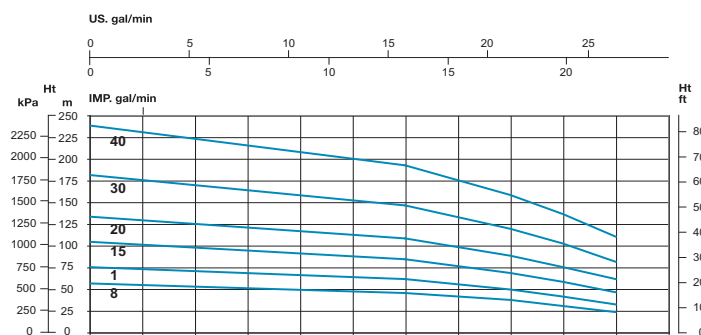
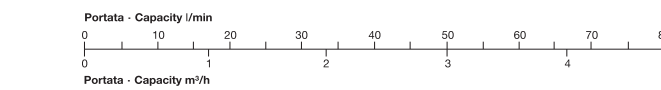
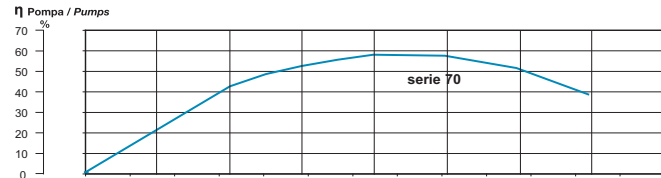
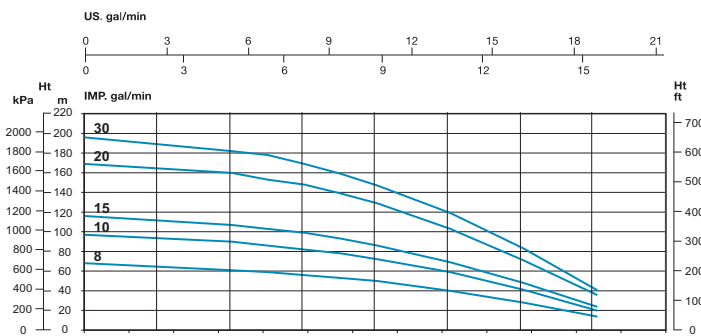
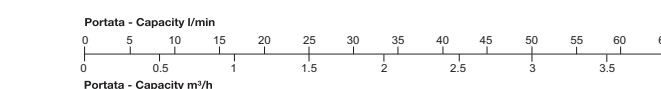
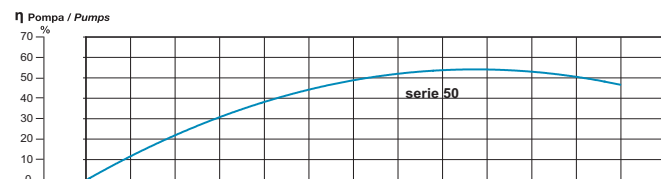
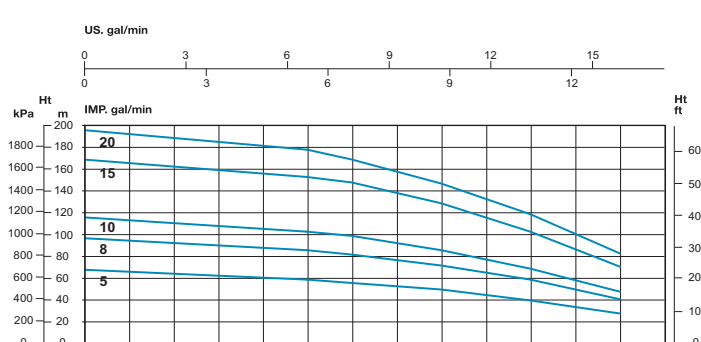

min⁻¹ ~ 2900

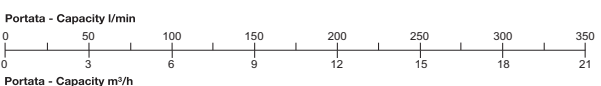
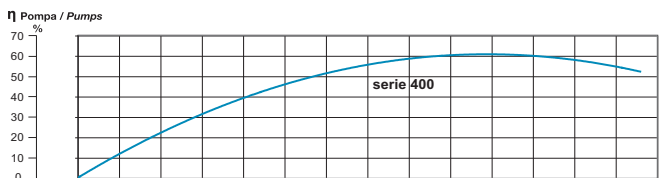
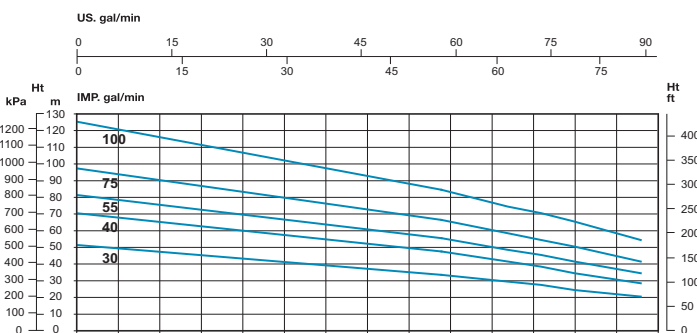
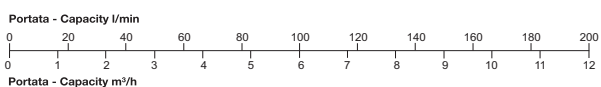
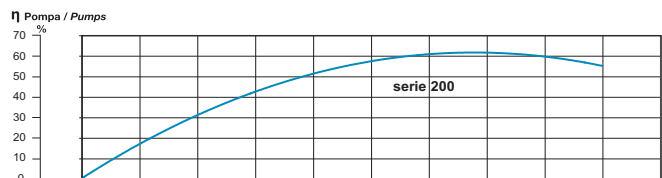
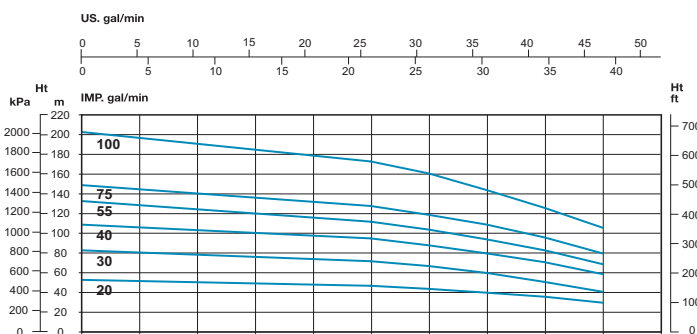
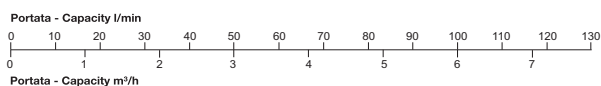
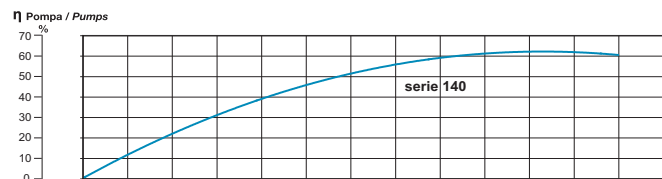
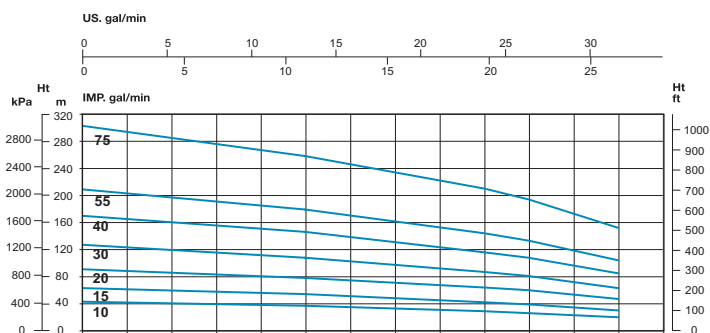

min⁻¹ ~ 3400

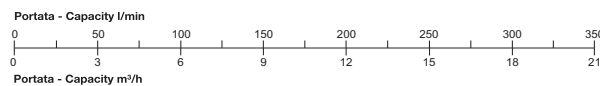
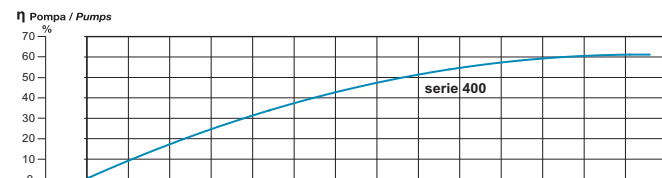
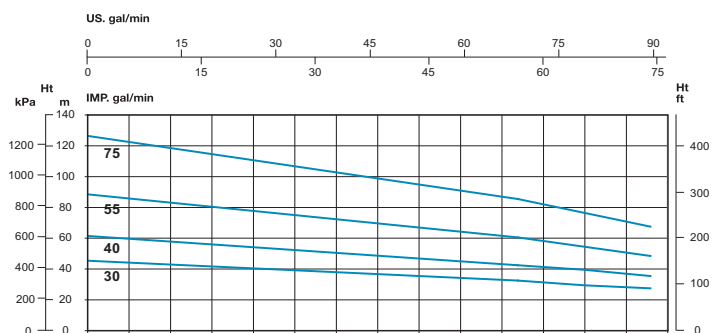
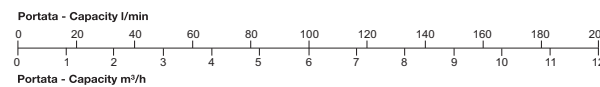
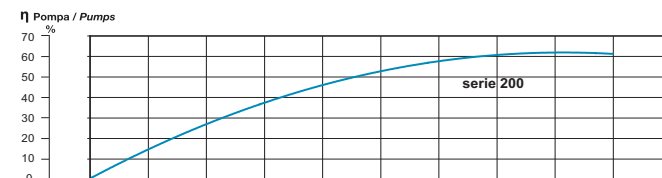
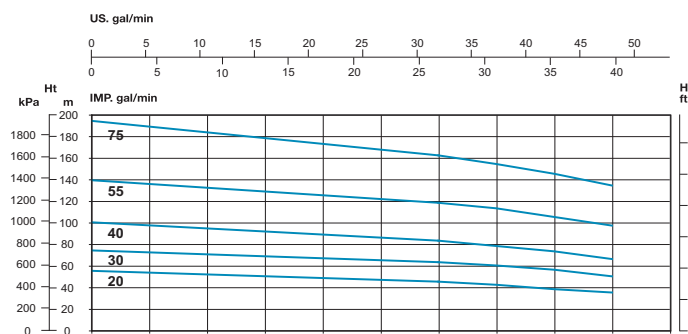
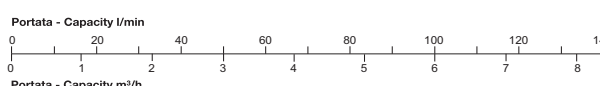
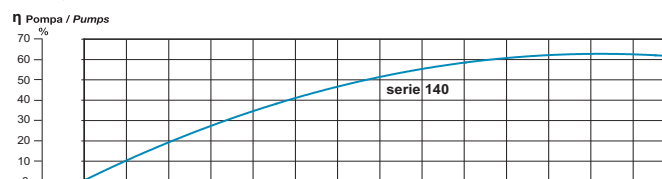
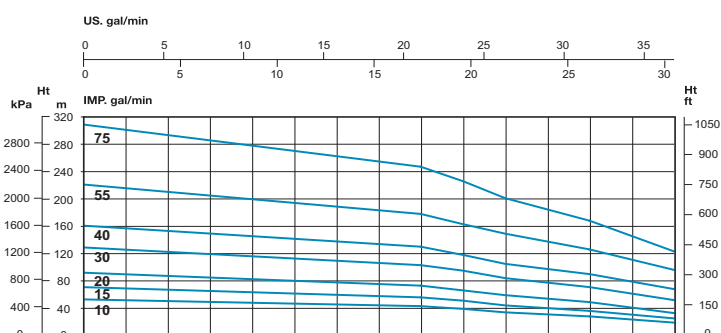

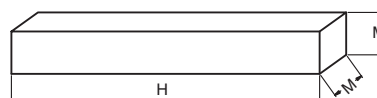
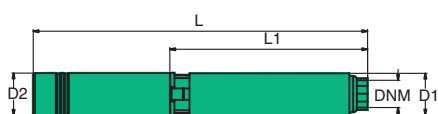

TIPO TYPE	DIMENSIONI [mm] DIMENSIONS [mm]				IMBALLO [mm] PACKING [mm]		PESO [kg] WEIGHT [kg]	
	L1	L	D1	DNM	H	M	Pompa	Totale
SL 50 - 05	290	615	98	1" 1/4	665	160	2,9	9,9
SL 50 - 08	332	657	98	1" 1/4	707	160	3,5	11,1
SL 50 - 10	402	752	98	1" 1/4	802	160	4,2	12,9
SL 50 - 15	507	902	98	1" 1/4	952	160	5,3	15,6
SL 50 - 20	580	1000	98	1" 1/4	1050	160	7,1	19,1
SL 70 - 08	283	608	98	1" 1/4	658	160	2,8	10,4
SL 70 - 10	342	692	98	1" 1/4	742	160	3,4	12,1
SL 70 - 15	430	825	98	1" 1/4	875	160	4,2	14,5
SL 70 - 20	519	939	98	1" 1/4	989	160	5	17
SL 70 - 30	749	1219	98	1" 1/4	1269	160	7,1	21,3
SL 100 - 08	301	626	98	1" 1/4	676	160	3	10,6
SL 100 - 10	344	694	98	1" 1/4	744	160	3,3	12
SL 100 - 15	452	847	98	1" 1/4	897	160	4,1	14,4
SL 100 - 20	538	958	98	1" 1/4	1008	160	4,7	16,7
SL 100 - 30	757	1227	98	1" 1/4	1277	160	6,2	20,4
SL 100 - 40	934	1478	98	1" 1/4	1528	160	7,9	23,4
SL 100 - 55	1128	1702	98	1" 1/4	1752	160	9,3	24,8
SL 140 - 10	390	740	98	2"	790	160	3,7	12,4
SL 140 - 15	483	878	98	2"	928	160	4,6	14,9
SL 140 - 20	607	1027	98	2"	1077	160	5,7	17,7
SL 140 - 30	831	1301	98	2"	1351	160	7,5	21,7
SL 140 - 40	1048	1592	98	2"	1642	160	9,8	28,8
SL 140 - 55	1318	1892	98	2"	1942	160	12,2	32,2
SL 140 - 75	1802	2446	98	2"	2496	160	15,9	38,3
SL 200 - 20	418	838	98	2"	888	160	4	16
SL 200 - 30	573	1043	98	2"	1093	160	5,5	19,7
SL 200 - 40	697	1241	98	2"	1291	160	6,6	25,6
SL 200 - 55	859	1433	98	2"	1483	160	7,8	27,8
SL 200 - 75	921	1565	98	2"	1615	160	8,4	30,8
SL 200 - 100	1236	2041	98	2"	2091	160	11	38
SL 400 - 30	675	1145	98	2"	1195	160	6,3	20,5
SL 400 - 40	880	1424	98	2"	1474	160	8,1	27,1
SL 400 - 55	1013	1587	98	2"	1637	160	9,3	29,3
SL 400 - 75	1149	1793	98	2"	1843	160	10,6	33
SL 400 - 100	1489	2294	98	2"	2344	160	13,5	40,5

"SL6"



NOMENCLATURA PARTI DI RICAMBIO
SPARE PARTS LIST
NOMENCLATURE PIECES DE RECHANGE
NOMENCLATURA REPUESTOS

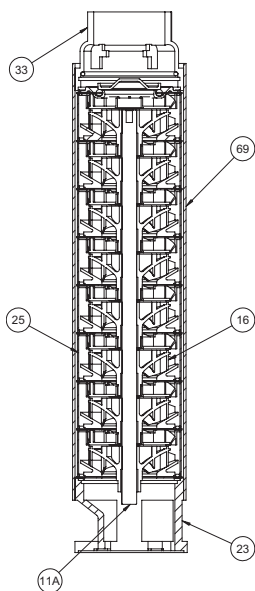

- 11A** Albero pompa – Pump shaft
Arbre pompe – Eje de la bomba
- 16** Girante – Impeller
Turbine – Impulsor
- 23** Corpo flangia aspirante – Suction flange body
Corp bride aspirant – Cuerpo brida entrega
- 25** Diffusore – Diffuser
Diffuseur – Difusor
- 33** Flangia mandata – Outlet flange
Bride envoyée – brida entrega
- 69** Camicia – Cover
Chemise – Camisa

POMPE SOMMERSE DA 6" IN ACCIAIO INOX

Le pompe sommerse da 6" della serie "SL6" sono state progettate per essere installate in pozzi da Ø 6-8" (150/200mm), e per pompare acque pulite o con leggera presenza di sabbia (40g/m³max.), senza corpi solidi in sospensione, non esplosivi o aggressivi per i materiali della pompa. Temperatura max. del liquido fino a 35 °C per uso domestico (CEI EN 60335-2-41) o 40 °C per altri usi. Grazie alla sua particolare costruzione, la valvola di non ritorno integrata nella testata preserva i giranti ed i diffusori da peso della colonna d'acqua e da eventuali colpi d'ariete.

CARATTERISTICHE COSTRUTTIVE

- Testata pompa: in microfusione di acciaio inox Aisi 304
- Flangia di aspirazione: in microfusione di acciaio inox Aisi 304
- Valvola di non ritorno: in acciaio inox Aisi 304
- Albero pompa: in acciaio inox Aisi 304
- Camicia esterna e filtro: in acciaio inox Aisi 304
- Diffusori: Tecnopolimero con distanziali e piatto usura in acciaio inox Aisi 304
- Giranti: Tecnopolimero con anello usura in poliuretano

POMPES IMMERGÉES DE 6" EN ACIER INOX

Les pompes immergées de 6" de la série "SL6" ont été conçues pour être installées dans des puits d'au moins de Ø 6-8" (150/200mm), et pour pomper des eaux propres ou avec une légère présence de sable (40g/m³max.), sans corps liquides en suspension, non explosifs ou agressifs pour les matériaux de la pompe. Température max. du liquide jusqu'à 35 °C pour utilisation domestique (CEI EN 60335-2-41) ou 40 °C pour d'autres utilisations. Grâce à sa construction particulière, le clapet de non-retour intégré dans la tête préserve les roues et les diffuseurs du poids de la colonne d'eau et d'éventuels coups de bélier.

CARACTERISTIQUES DE CONSTRUCTION

- Tête de pompe: moulage de précision d'acier inox Aisi 304
- bride d'accouplement: moulage de précision d'acier inox Aisi 304
- Clapet anti-retour: acier inox Aisi 304
- Abre de pompe: acier inox Aisi 304
- Chemise extérieures et le filtre: acier inox Aisi 304
- Diffuseurs: Technopolymère avec entretoises et d'usure en acier inox AISI 304
- Turbine: Technopolymère avec anneau d'usure en polyuréthane

SUBMERSIBLE PUMPS FOR 6" WELLS IN STAINLESS STEEL

The 6" submersible pumps of the series "SL6" have been designed to be installed in Ø 6-8" wells (150/200 mm) and to pump clean water or water with the slight presence of sand (40 g/m³max.), without suspended solids. Temperatures not higher than 35 °C for domestic use (CEI EN 60335-2-41) or 40 °C for other use, while the ambient temperature must not be higher than 40 °C. Thanks to the particular design, the non-return valve, integrated in the upper head preserves the impellers and diffuser from the weight of the column and eventual water hammers.

TECHNICAL FEATURES

- Upper head of the pump: in precision-cast stainless steel Aisi 304
- Suction flange: in precision-cast stainless steel Aisi 304
- Check valve: in stainless steel Aisi 304
- Pump shaft: in stainless steel Aisi 304
- Outside sleeve: in stainless steel Aisi 304
- Diffusers: Techno-polymer with spacer and wear disk in stainless steel Aisi 304
- Impellers: Techno-polymer with wear disk in polyurethane

BOMBAS SUMERGIDAS DA 6" IN ACCIAIO INOX

Las bombas sumergidas de 6" de la serie "SL6" han sido proyectadas su instalación en pozos de Ø 6-8" (150/200mm), y para el bombeo de aguas limpias o con ligera presencia de arena (40g/m³max.), sin cuerpos sólidos en suspensión, que no sean explosivos ni agresivos para los materiales de la bomba. Temperatura max. del líquido hasta 35 °C para uso doméstico (CEI EN 60335-2-41) o 40 °C para otros usos. Gracias a su especial construcción, la válvula anti-retorno integrada en el cabezal preserva los impulsores y los difusores del peso de la columna de agua y de eventuales golpes de ariete.

CARACTERISTICAS DE CONSTRUCCIÓN

- Cabeza de la bomba: fundición en acero inoxidable AISI 304
- Brida de conexión: de fundición de acero inoxidable AISI 304
- Válvula de retención: De acero Inox AISI 304
- Eje de la bomba: de acero Inox AISI 304
- Camisa y filtro de aspiración: En acero Inox AISI 304
- Difusores: De tecnopolímero
- Rodetes: De tecnopolímero

50 Hz

TIPO TYPE	Potenza nominale Nominal power		Portata - Capacity																				
	kW	HP	Q [m ³ /h]	0	4.8	6	7.2	8.4	9.6	10.8	12	13.2	15	18	24	30	36	42	48	54	60	66	
a			Q [l/1']	0	80	100	120	140	160	180	200	220	250	300	400	500	600	700	800	900	1000	1100	
Prevalenza (m C.A.) Total head (m W.C.)																							
SL6 - H 30 (1)	2.2	3	81	74	70	67	63	58	53	47	39	26											
SL6 - H 40 (1)	3	4	114	104	97	93	88	81	75	66	55	37											
SL6 - H 55 (1)	4	5.5	147	134	125	120	114	105	96	85	71	46											
SL6 - H 75 (1)	5.5	7.5	196	180	172	163	152	140	128	113	95	64											
SL6 - H 100	7.5	10	244	226	216	205	190	175	160	141	118	80											
SL6 - H 125	9.2	12.5	293	270	250	245	228	210	193	169	142	96											
SL6 - H 126	9.2	12.5	342	315	291	286	266	245	225	197	166	112											
SL6 - H 150	11	15	391	360	333	327	304	280	257	226	190	128											
SL6 - H 175	13	17.5	456	420	388	382	354	326	300	263	221	149											
SL6 - I 30 (1)	2.2	3	62			60	58	56	53	51	48	42	29										
SL6 - I 40 (1)	3	4	78			75	72	69	66	64	60	52	36										
SL6 - I 55 (1)	4	5.5	94			89	87	83	80	76	72	63	44										
SL6 - I 75 (1)	5.5	7.5	140			134	130	125	120	114	108	95	66										
SL6 - I 100	7.5	10	187			179	173	167	160	153	144	127	88										
SL6 - I 125	9.2	12.5	234			223	216	209	201	191	180	158	110										
SL6 - I 150	11	15	281			268	260	251	241	229	216	190	132										
SL6 - I 175	13	17.5	328			313	304	293	281	267	251	222	154										
SL6 - I 200	15	20	374			358	347	335	321	305	287	254	176										
SL6 - I 250	18.5	25	468			447	434	419	401	381	359	317	220										
SL6 - L 40 (1)	3	4	46							40	38.7	37.3	36	30	21	11							
SL6 - L 55 (1)	4	5.5	61							53	51.3	49.7	48	40	28	15							
SL6 - L 75 (1)	5.5	7.5	91							80	77.0	74.0	71	59	42	22							
SL6 - L 100	7.5	10	122							106	102.3	98.7	95	79	56	30							
SL6 - L 125	9.2	12.5	152							133	128.3	123.7	119	99	71	37							
SL6 - L 150	11	15	182							159	153.7	148.3	143	119	86	47							
SL6 - L 175	13	17.5	213							186	179.7	173.3	167	139	100	56							
SL6 - L 200	15	20	243							212	204.7	197.3	190	158	114	64							
SL6 - L 250	18.5	25	304							265	256.0	247.0	238	198	142	80							
SL6 - L 300	22	30	365							318	307.3	296.7	286	238	170	96							
SL6 - N 40 (1)	3	4	31										28	27	24	20	14	8					
SL6 - N 55 (1)	4	5.5	48										42	39	36	30	21	12					
SL6 - N 75 (1)	5.5	7.5	63										57	53	48	40	28	16					
SL6 - N 100	7.5	10	78										71	66	60	50	36	20					
SL6 - N 125	9.2	12.5	94										85	80	72	60	43	23					
SL6 - N 150	11	15	126										114	106	96	80	57	31					
SL6 - N 175	13	17.5	141										128	120	108	90	64	35					
SL6 - N 200	15	20	157										142	133	119	100	71	39					
SL6 - N 250	18.5	25	188										170	160	143	120	86	47					
SL6 - N 300	22	30	235										213	199	179	150	107	59					
SL6 - N 350	26	35	283										256	239	214	180	128	71					
SL6 - N 400	30	40	314										284	266	238	200	142	78					
SL6 - P 55 (1)	4	5.5	26												21	18	16	14	12	10	4		
SL6 - P 75 (1)	5.5	7.5	40												32	28	25	22	18	13	7		
SL6 - P 100	7.5	10	52												43	38	33	29	23	17	9		
SL6 - P 125	9.2	12.5	65												54	48	41	36	29	21	11		
SL6 - P 150	11	15	78												64	57	50	44	36	26	13		
SL6 - P 175	13	17.5	104												86	77	67	58	47	34	18		
SL6 - P 200	15	20	118												97	86	75	66	53	38	20		
SL6 - P 250	18.5	25	131												108	96	83	73	59	42	23		
SL6 - P 300	22	30	158												129	114	100	88	71	51	27		
SL6 - P 350	26	35	197												161	144	125	110	89	64	34		
SL6 - P 400	30	40	236												194	173	150	130	106	77	41		

(1) Coupled with 4" motor

(1) Accoppiato con motore 4"

min⁻¹ ~ 2900

min⁻¹ ~ 3400

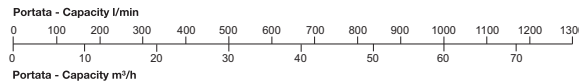
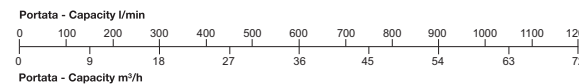
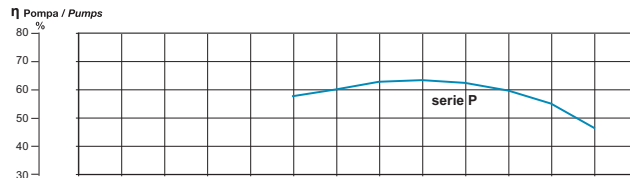
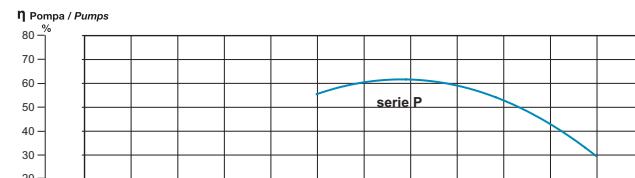
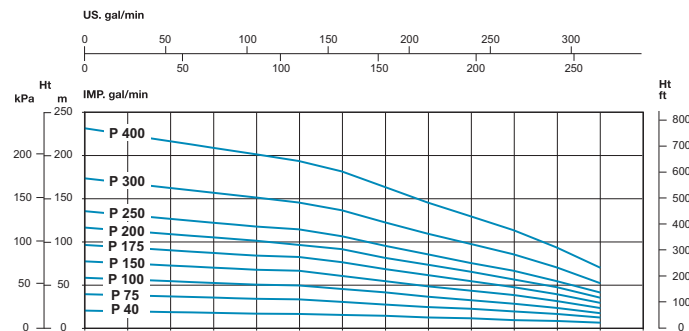
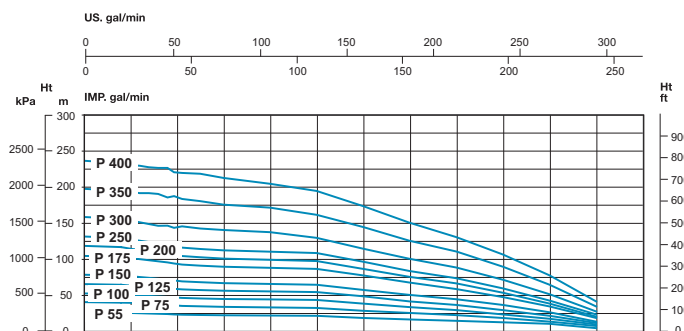
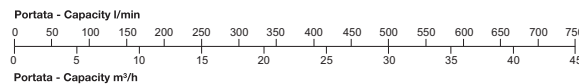
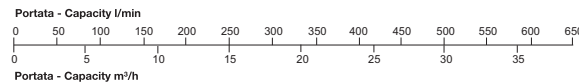
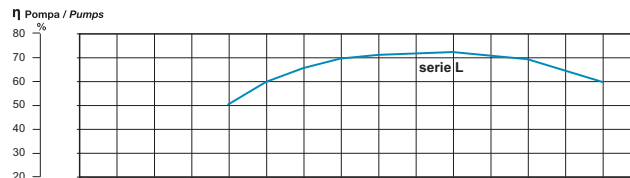
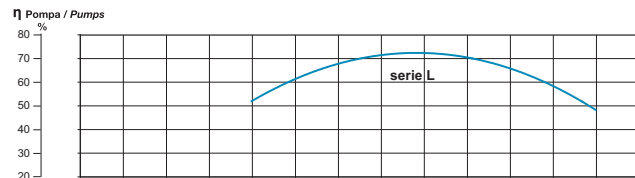
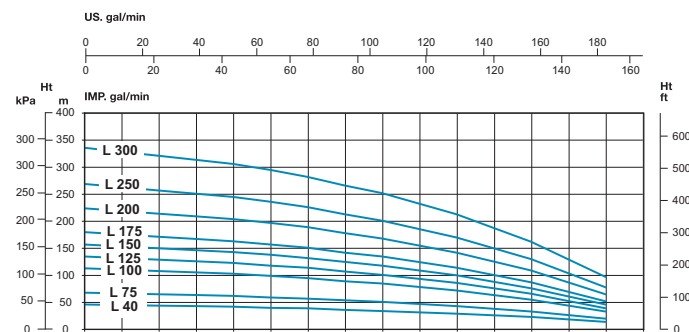
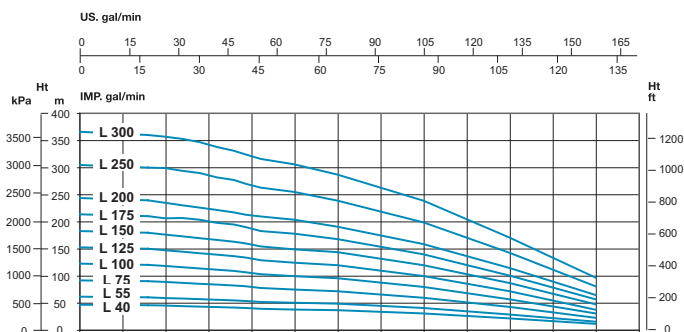
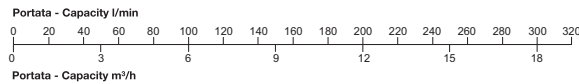
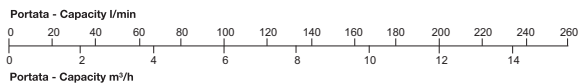
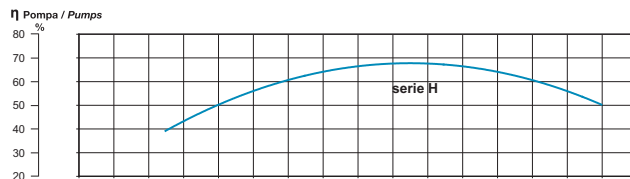
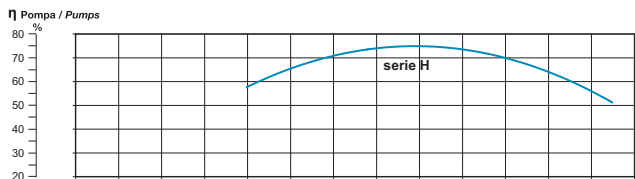
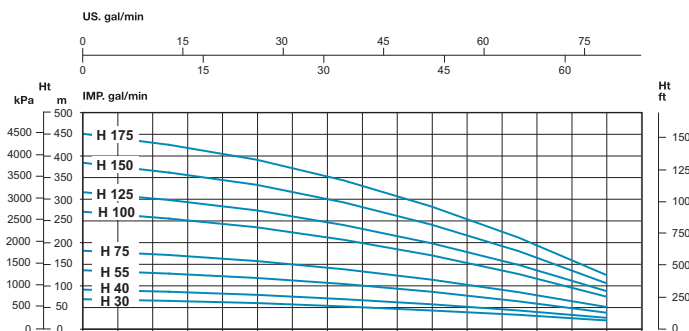
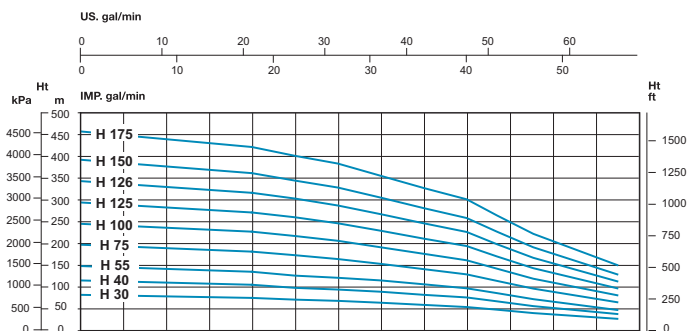

min⁻¹ ~ 2900

min⁻¹ ~ 3400

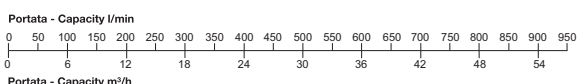
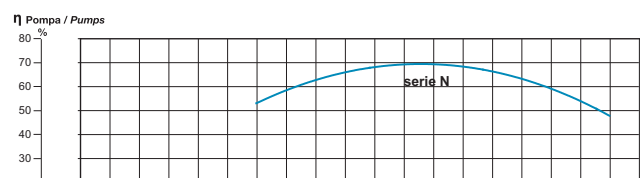
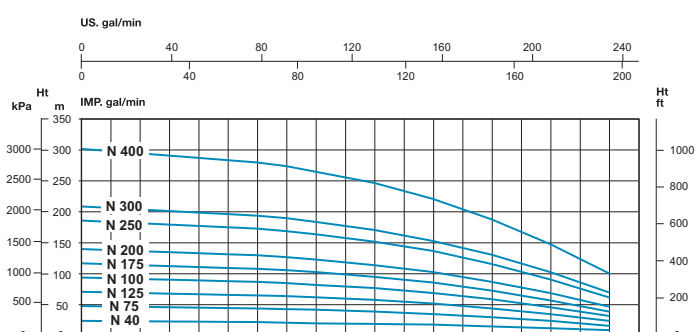
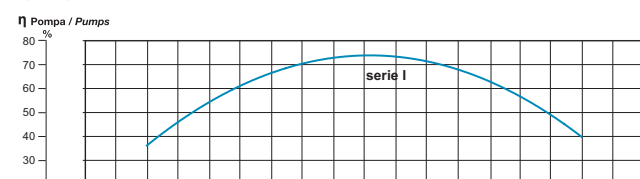
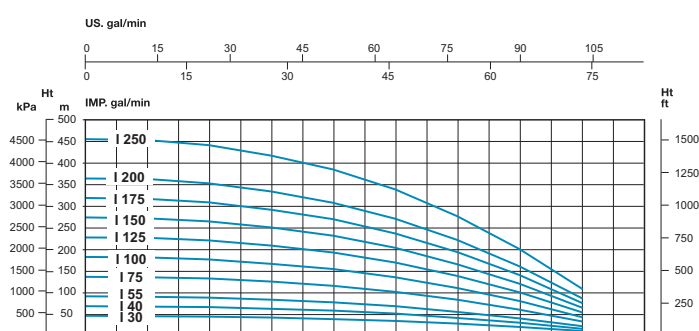
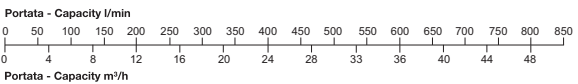
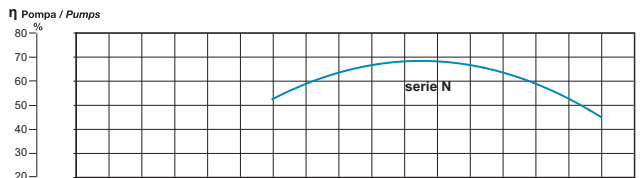
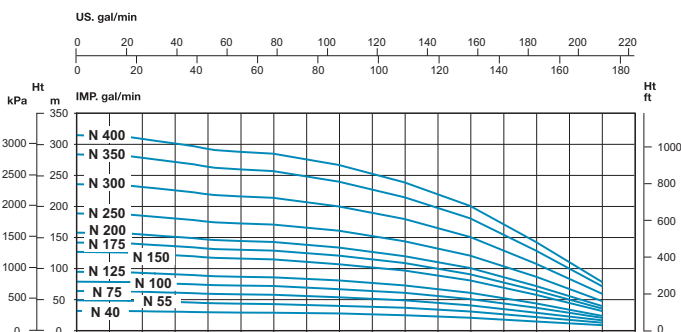
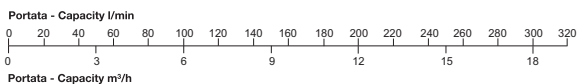
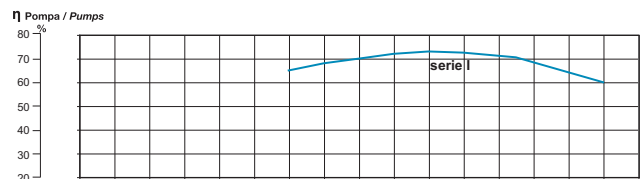
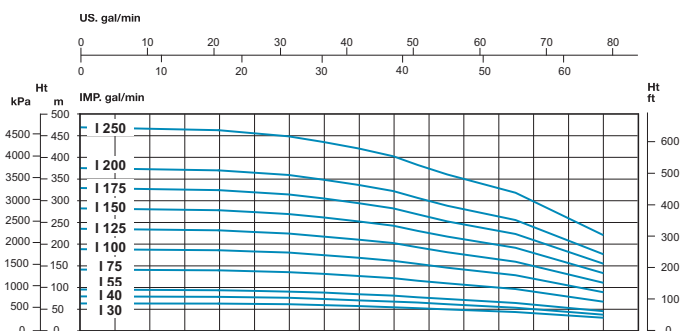

50 Hz

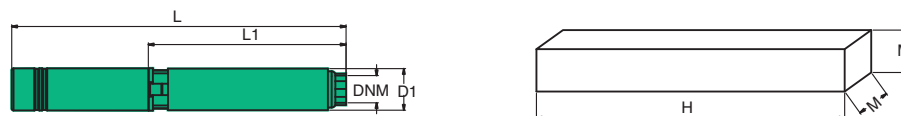

TIPO TYPE	DIMENSIONI [mm] DIMENSIONS [mm]				IMBALLO [mm] PACKING [mm]		PESO [kg] WEIGHT [kg]	
	L1	L	D1	DNM	H	M	Pompa	Totale
SL6 - H 30 (1)	478	834	135	3"	884	160	8,5	22
SL6 - H 40 (1)	549	972	135	3"	1022	160	9,5	25,5
SL6 - H 55 (1)	625	1208	135	3"	1258	160	11	32,8
SL6 - H 75 (1)	738	1435	135	3"	1485	160	13,5	40,8
SL6 - H 100	852	1626	145	3"	1676	160	15	60,5
SL6 - H 125	966	1645	145	3"	1695	160	17	63,7
SL6 - H 126	1079	1758	145	3"	1808	160	19,5	66,2
SL6 - H 150	1193	1904	145	3"	1954	160	21	70
SL6 - H 175	1397	2173	145	3"	2223	160	23,5	80
SL6 - I 30 (1)	435	791	135	3"	841	160	8	21,5
SL6 - I 40 (1)	478	901	135	3"	951	160	8,5	30,3
SL6 - I 55 (1)	511	1056	135	3"	1106	160	9	29,8
SL6 - I 75 (1)	625	1322	135	3"	1372	160	11	38,3
SL6 - I 100	738	1512	145	3"	1562	160	13,5	45,5
SL6 - I 125	852	1531	145	3"	1581	160	15	61,7
SL6 - I 150	966	1677	145	3"	1727	160	17	66
SL6 - I 175	1079	1855	145	3"	1905	160	19	75,5
SL6 - I 200	1193	1969	145	3"	2019	160	21	77,5
SL6 - I 250	1474	2316	145	3"	2366	160	25	87
SL6 - L 40 (1)	454	877	135	3"	927	160	8	24
SL6 - L 55 (1)	511	1056	135	3"	1106	160	9	29,8
SL6 - L 75 (1)	625	1322	135	3"	1372	160	10,5	37,8
SL6 - L 100	738	1512	145	3"	1562	160	13	45
SL6 - L 125	852	1531	145	3"	1581	160	14,5	61,2
SL6 - L 150	966	1677	145	3"	1727	160	16	65
SL6 - L 175	1079	1855	145	3"	1905	160	17,5	74
SL6 - L 200	1193	1969	145	3"	2019	160	19	75,5
SL6 - L 250	1474	2316	145	3"	2366	160	24	86
SL6 - L 300	1700	2607	145	3"	2657	160	27,5	96,3
SL6 - N 40 (1)	403	826	135	3"	876	160	6,5	22,5
SL6 - N 55 (1)	463	1046	135	3"	1096	160	7,5	29,3
SL6 - N 75 (1)	522	1219	135	3"	1269	160	8,5	35,8
SL6 - N 100	582	1356	145	3"	1406	160	9,5	41,5
SL6 - N 125	642	1321	145	3"	1371	160	10,5	57,2
SL6 - N 150	762	1473	145	3"	1523	160	12	61
SL6 - N 175	822	1598	145	3"	1648	160	13	69,5
SL6 - N 200	882	1658	145	3"	1708	160	14	70,5
SL6 - N 250	1002	1844	145	3"	1894	160	15	78
SL6 - N 300	1182	2089	145	3"	2139	160	19	87,8
SL6 - N 350	1414	2451	145	3"	2501	160	22	106
SL6 - N 400	1534	2571	145	3"	2621	160	25	110
SL6 - P 55 (1)	403	948	135	3"	998	160	6,5	27,3
SL6 - P 75 (1)	463	1160	135	3"	1210	160	7,5	34,8
SL6 - P 100	522	1296	145	3"	1346	160	8,5	40,5
SL6 - P 125	582	1261	145	3"	1311	160	9,5	56,2
SL6 - P 150	642	1353	145	3"	1403	160	10,5	59,5
SL6 - P 175	762	1538	145	3"	1588	160	12	68,5
SL6 - P 200	822	1598	145	3"	1648	160	13	69,5
SL6 - P 250	882	1724	145	3"	1774	160	14	76
SL6 - P 300	1002	1909	145	3"	1959	160	16	84,8
SL6 - P 350	1182	2219	145	3"	2269	160	19	104
SL6 - P 400	1414	2451	145	3"	2501	160	22	107

60 Hz

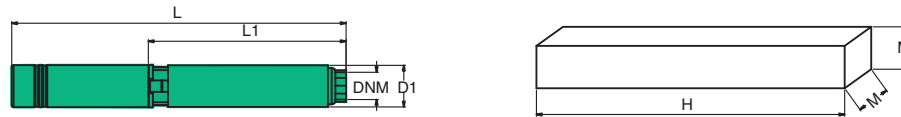

TIPO TYPE	DIMENSIONI [mm] DIMENSIONS [mm]				IMBALLO [mm] PACKING [mm]		PESO [kg] WEIGHT [kg]	
	L1	L	D1	DNM	H	M	Pompa	Totale
SL6 - H 30 (1)	402	822	140	3"	1240	200	7,1	19,1
SL6 - H 40 (1)	440	990	140	3"	1240	200	7,7	26,2
SL6 - H 55 (1)	516	1096	140	3"	1240	200	9,1	29,1
SL6 - H 75 (1)	592	1242	140	3"	1500	200	10,4	32,8
SL6 - H 100	744	1344	140	3"	1500	200	13	40
SL6 - H 125	820	1420	140	3"	1500	200	14,3	59,3
SL6 - H 150	934	1634	140	3"	1750	200	16,3	64,3
SL6 - H 175	1048	1748	140	3"	1750	200	18,3	68,3
SL6 - I 30 (1)	364	784	140	3"	1000	200	6,4	18,4
SL6 - I 40 (1)	402	952	140	3"	1240	200	7,1	25,6
SL6 - I 55 (1)	440	1020	140	3"	1240	200	7,7	27,7
SL6 - I 75 (1)	516	1166	140	3"	1240	200	9,1	31,5
SL6 - I 100	592	1192	140	3"	1240	200	10,4	52,4
SL6 - I 125	668	1268	140	3"	1500	200	11,7	56,7
SL6 - I 150	744	1444	140	3"	1500	200	13	61
SL6 - I 175	820	1520	140	3"	1750	200	14,3	64,3
SL6 - I 200	896	1656	140	3"	1750	200	15,7	69,7
SL6 - I 250	1048	1878	140	3"	2000	200	18,3	83,3
SL6 - L 40 (1)	402	952	140	3"	1240	200	6,9	25,4
SL6 - L 75 (1)	459	1109	140	3"	1240	200	7,8	30,2
SL6 - L 100	573	1173	140	3"	1240	200	9,6	51,6
SL6 - L 125	630	1230	140	3"	1500	200	10,4	55,4
SL6 - L 150	687	1387	140	3"	1500	200	11,3	59,3
SL6 - L 175	744	1444	140	3"	1500	200	12,2	62,2
SL6 - L 200	858	1618	140	3"	1750	200	14	68
SL6 - L 250	972	1802	140	3"	2000	200	15,8	80,8
SL6 - L 300	1143	2033	140	3"	2150	200	18,5	88,5
SL6 - N 40 (1)	348	898	140	3"	1240	200	6	24,5
SL6 - N 75 (1)	408	1058	140	3"	1240	200	6,9	29,3
SL6 - N 100	468	1068	140	3"	1240	200	7,8	49,8
SL6 - N 125	528	1128	140	3"	1240	200	8,7	53,7
SL6 - N 175	588	1288	140	3"	1500	200	9,6	59,6
SL6 - N 200	648	1408	140	3"	1500	200	10,4	64,4
SL6 - N 250	768	1598	140	3"	1750	200	12,2	77,2
SL6 - N 300	828	1718	140	3"	1750	200	13,1	83,1
SL6 - N 400	1068	2098	140	3"	2150	200	16,7	106,7
SL6 - P 40 (1)	348	898	140	3"	1240	200	6	24,5
SL6 - P 75 (1)	408	1058	140	3"	1240	200	6,9	29,3
SL6 - P 100	468	1068	140	3"	1240	200	7,8	49,8
SL6 - P 150	528	1228	140	3"	1500	200	8,7	56,7
SL6 - P 175	588	1288	140	3"	1500	200	9,6	59,6
SL6 - P 200	648	1408	140	3"	1500	200	10,4	64,4
SL6 - P 250	708	1538	140	3"	1750	200	11,3	76,3
SL6 - P 300	828	1718	140	3"	1750	200	13,1	83,1
SL6 - P 400	1008	2038	140	3"	2150	200	15,8	105,8

"SUBMOTO 4"

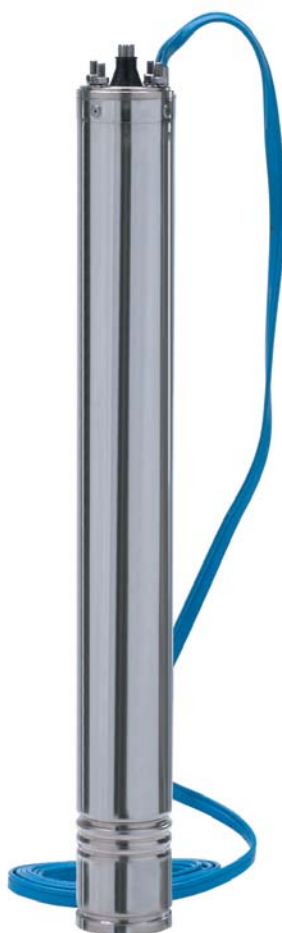

MOTORE SOMMERSO CON STATORE RIAVVOLGIBILE PER POZZI DA 4"

I motori sommersi con statore riavvolgibile sono raffreddati con liquido refrigerante atossico per usi alimentari a norme F.D.A. (Food and Drug Administration). Essi sono costruiti in modo tradizionale, ma con interessanti innovazioni ed utilizzando solo materiali di elevatissima qualità. Grazie alla continua lubrificazione di tutte le parti in movimento, questi motori risultano estremamente affidabili nel tempo. Statore riavvolgibile con estrema facilità.

CARATTERISTICHE COSTRUTTIVE

Motore tipo asincrono sommerso, a due poli, grado di protezione IP 58, classe di isolamento F. Disponibile in versione monofase o trifase con protezione termica a cura dell'utente, la versione monofase (PSC) viene fornito senza condensatore.

Servizio: S1 (se completamente immerso)

Avviamenti orari max. :30.

- Flangia a norme NEMA
- Estensione albero in acciaio inox Aisi 303
- Camicia esterna acciaio inox Aisi 304
- Supporti in ghisa al nichel ricoperti in acciaio inox Aisi 304
- Tenuta meccanica carbone-ceramica con labirinto parasabbia
- 1,5 m cavo d'alimentazione a 4 fili
- Connettore estraibile a tenuta stagna con innesto rapido
- Massima immersione 150 m.

A RICHIESTA:

- Quadro elettrico di comando e protezione marcia a secco
- Cavo elettrico cablato con lunghezza desiderata
- Kit per connessione cavi

4" WELLS SUBMERSIBLE MOTOR WITH REWINDABLE STATOR

The submersible 4" motors with rewindable stator cooled by non-toxic oil suitable for foodstuffs uses approved by F.D.A. (Food and Drug Administration). They are manufactured following the classic standards, but with high-tech procedures and using only high quality materials. Thanks to the Continuous lubrication of all the parts in movement by the filled liquid, these motors are extremely reliable in time. It is particularly easy to rewind the stator.

TECHNICAL FEATURES

Asynchronous submersible motor with protection IP58, two poles, class F insulation. Available in single-phase or three-phase version with compulsory protection to be supplied by the user, the single-phase version (PSC) is supplied without capacitor.

Service: S1 (if completely submersed)

Max. 30 starts per hour.

- Flange at NEMA standards
- Shaft extension in stainless steel Aisi 303
- Outside shell in stainless steel Aisi 304
- Brackets in nickel coated cast iron
- Mechanical seal in graphite-ceramic with sand fighter labyrinth
- Quick cable coupling watertight connector
- 1,5 m 4 wire feeding cable
- Max immersion 150 m.

ON REQUEST:

- Control panel with thermal and dry running protection
- Coupled electric cable with desired length
- Electric cable Joint Kit

MOTEUR IMMERGÉ AVEC STATOR RÉENROULABLE POUR PUIXS DE 4"

Les moteurs immergés avec stator réenroulable sont refroidis avec un liquide réfrigérant atoxique pour usages alimentaires aux normes F.D.A. (Food and Drug Administration). Ils sont construits de façon traditionnelle, mais avec d'intéressantes innovations et en utilisant uniquement des matériaux de très haute qualité. Grâce à la lubrification continue de toutes les pièces en mouvement, ces moteurs s'avèrent extrêmement fiables dans le temps. Stator réenroulable avec une extrême facilité.

CARACTERISTIQUES DE CONSTRUCTION

Moteur immergés à induction avec protection IP68, classe d'isolation F. Disponible en monophasé ou triphasé avec protection thermique fournie par l'utilisateur, la monophasés (PSC) est fourni sans le condensateur. service S1 (s'il est complètement immergé) Démarrages par heure : 30 max.

- Bride a norme NEMA
- Extension arbre en acier inox AISI 303
- Tuyau externe en acier inox AISI 304
- Support en fonte au nickel avec revêtement en acier inox AISI 304
- Garniture mécanique en carbone céramique avec labyrinthe de protection de sable
- 1,5 m câble d'alimentation à 4 fils
- Connecteur étanche avec attache rapide
- Immersion maximale de 150 m.

SUR DEMANDE:

- Coffré électrique de commande et protection fonctionnement à sec
- Câble électrique câblé avec longueur sur demande
- Kit de connexion pour câble.

MOTOR SUMERGIDO CON ESTATOR REBOBINABLE PARA POZOS DE 4"

Los motores sumergidos con estator rebobinable se enfrían con un líquido refrigerante atóxico apto para usos alimentarios conforme las normas de la F.D.A. (Food and Drug Administration). Están contruidos en el modo tradicional, aunque con la introducción de interesantes innovaciones y utilizando sólo materiales de elevadísima cualidad. Gracias a la lubricación continuada de todas las partes en movimiento, estos motores resultan extremadamente fiables en el tiempo. El estator se rebobina con mucha facilidad.

CARACTERISTICAS DE CONSTRUCCIÓN

Motor asíncrono sumergido con proteccion IP58, aislamiento de clase F. Disponible en mono o trifásico, de la protección se encarga el usuario. y el equipo recomendado de acuerdo con las normas, la monofásica (Psc) se suministra sin el condensador. funcionamiento S1 (si es completamente sumergido) Arranques por hora max. :30

- Brida a norme NEMA, de fundición gris tattada al níquel
- Borne de eje en acero inoxidable Aisi 303
- Camisa externa en acero inoxidable AISI 304
- Cierre mecánico: De cerámica y grafito con protector anti-arena
- Cable de alimentación :1,5 m.
- Conector extraíble impermeable con cierre rápido
- Máxima inmersión 150 m.

A RICHIESTA:

- Cuadro de control eléctrico y protección contra el funcionamiento en seco
- Longitud de cable deseado
- Kit de conexión por el cable.

Alimentaz. Feeding	Potenza nominale Nominal power		Corrente assorbita [A] Input current [A]		cos φ (Pf.)	η (Eff.) [%]	Condensatore Capacitor [µF]	S.F. S.F.	Velocità Speed [RPM]	Dimensione cavi - Cable Dimension														
	[kW]	[HP]	I _N	I _{START}						Sez. mm2	4x1,5	4x2,5	4x4	4x6	4x10	4x16	4x25							
	Monofase Single Phase	0.37	0.5	3.4	10.2	0.94	53	20	1.6	2860	Lunghezza max. in metri del cavo dal motore al quadro di comando (caduta di tensione ≤ 3%) Max.cable length in meters from motor to control panel (tension drop ≤ 3%)	120	200	320	480	810	1260	1900						
0.55		0.75	4.6	13.6	0.94	58	25	1.5	2855	80									130	220	320	550	850	1290
0.74		1	5.8	18.5	0.96	63	35	1.4	2855	60									100	170	250	430	670	1010
1.1		1.5	7.8	26	0.97	67	40	1.3	2840	40									70	120	180	300	470	710
1.47		2	10.6	34	0.98	65	60	1.25	2850	30									60	90	130	230	360	550
2.2		3	14.9	48	0.97	68	80	1.15	2850	20									40	60	90	150	230	350
0.37		0.5	1.45	5	0.71	58		1.6	2830	810									1350	2160	3240	5500	8530	
Trifase Three Phase	0.55	0.75	1.75	7	0.72	62		1.5	2830	410									680	1090	1640	2780	4330	6570
	0.74	1	2.4	10	0.75	67		1.4	2830	330									530	820	1230	2100	3340	4980
	1.1	1.5	3.4	14	0.74	67		1.3	2820	220									370	590	880	1500	2340	3560
	1.47	2	4.4	17	0.69	74		1.25	2830	150									250	400	600	1030	1600	2440
	2.2	3	6	24	0.73	75		1.15	2820	110									190	310	460	790	1230	1880
	3	4	7.9	34	0.77	75		1.15	2850	90									150	240	370	630	980	1490
	4	5.5	10.8	47	0.71	78		1.15	2850	80									140	230	340	590	920	1390
	5.5	7.5	14.4	58	0.75	77		1.15	2830	60	110	170	260	440	690	1060								
7.5	10	19.5	72	0.78	80		1.15	2820	50	80	130	200	330	530	8100									

"SUBMOTO 6"



■ MOTORE SOMMERSO CON STATORE RIAVVOLGIBILE PER POZZI DA 6"

I motori sommersi con statore riavvolgibile sono raffreddati con liquido refrigerante atossico per usi alimentari a norme F.D.A. (Food and Drug Administration). Essi sono costruiti in modo tradizionale, ma con interessanti innovazioni ed utilizzando solo materiali di elevatissima qualità. Grazie alla continua lubrificazione di tutte le parti in movimento, questi motori risultano estremamente affidabili nel tempo. Statore riavvolgibile con estrema facilità.

CARATTERISTICHE COSTRUTTIVE

Motore tipo asincrono sommerso, a due poli, grado di protezione IP 58, classe di isolamento F. Disponibile in versione monofase o trifase con protezione termica a cura dell'utente, la versione monofase (PSC) viene fornito senza condensatore.

Servizio: S1 (se completamente immerso)
Avviamenti orari max. :30.

- Flangia a norme NEMA
- Estensione albero in acciaio inox Aisi 303
- Camicia esterna acciaio inox Aisi 304
- Supporti in ghisa al nichel ricoperti in acciaio inox Aisi 304
- Tenuta meccanica carbone-ceramica con labirinto parasabbia
- 1,5 m cavo d'alimentazione a 4 fili
- Connettore estraibile a tenuta stagna con innesto rapido
- Massima immersione 350 m.

A RICHIESTA:

- Quadro elettrico di comando e protezione
- Cavo elettrico cablato con lunghezza desiderata
- Kit per connessione cavi

■ 6" WELLS SUBMERSIBLE MOTOR WITH REWINDABLE STATOR

The submersible motors with rewindable stator cooled by non-toxic oil suitable for foodstuffs uses approved by F.D.A. (Food and Drug Administration). They are manufactured following the classic standards, but with high-tech procedures and using only high quality materials. Thanks to the Continuous lubrication of all the parts in movement by the filled liquid, these motors are extremely reliable in time. It is particularly easy to rewind the stator.

TECHNICAL FEATURES

Asynchronous submersible motor with protection IP58, two poles, class F insulation. Available in single-phase or three-phase version with compulsory protection to be supplied by the user, the single-phase version (PSC) is supplied without capacitor.

Service: S1 (if completely submersed)
Max. 30 starts per hour.

- Flange at NEMA standards
- Shaft extension in stainless steel Aisi 303
- Outside shell in stainless steel Aisi 304
- Brackets in nickel coated cast iron
- Mechanical seal in graphite-ceramic with sand fighter labyrinth
- Quick cable coupling watertight connector
- 1,5 m 4 wire feeding cable
- Max immersion 350 m.

ON REQUEST:

- Control panel with thermal and protection
- Coupled electric cable with desired length
- Electric cable Joint Kit

MOTEUR IMMÉRGÉ AVEC STATOR RÉENROULABLE POUR PUIXS DE 6"

Les moteurs immergés avec stator réenroulable sont refroidis avec un liquide réfrigérant atoxique pour usages alimentaires aux normes F.D.A. (Food and Drug Administration). Ils sont construits de façon traditionnelle, mais avec d'intéressantes innovations et en utilisant uniquement des matériaux de très haute qualité. Grâce à la lubrification continue de toutes les pièces en mouvement, ces moteurs s'avèrent extrêmement fiables dans le temps. Stator réenroulable avec une extrême facilité.

CARACTERISTIQUES DE CONSTRUCTION

Moteur immergés à induction avec protection IP68, classe d'isolation F. Disponible en monophasé ou triphasé avec protection thermique fournie par l'utilisateur, la monophasés (PSC) est fourni sans le condensateur. service S1 (s'il est complètement immergé) Démarrages par heure : 30 max.

- Bride a norme NEMA
- Extension arbre en acier inox AISI 303
- Tuyau externe en acier inox AISI 304
- Support en fonte au nickel avec revêtement en acier inox AISI 304
- Garniture mécanique en carbone céramique avec labyrinthe de protection de sable
- 1,5 m câble d'alimentation à 4 fils
- Connecteur étanche avec attache rapide
- immersion maximale de 350 m.

SUR DEMANDE:

- Coffré électrique de commande et protection
- Câble électrique câblé avec longueur sur demande
- Kit de connexion pour câble.

MOTOR SUMERGIDO CON ESTATOR REBOBINABLE PARA POZOS DE 6"

Los motores sumergidos con estator rebobinable se enfrían con un líquido refrigerante atóxico apto para usos alimentarios conforme las normas de la F.D.A. (Food and Drug Administration). Están contruidos en el modo tradicional, aunque con la introducción de interesantes innovaciones y utilizando sólo materiales de elevadísima cualidad. Gracias a la lubricación continuada de todas las partes en movimiento, estos motores resultan extremadamente fiables en el tiempo. El estator se rebobina con mucha facilidad.

CARACTERISTICAS DE CONSTRUCCIÓN

Motor asíncrono sumergido con proteccion IP58, aislamiento de clase F. Disponible en mono o trifásico, de la protección se encarga el usuario. y el equipo recomendado de acuerdo con las normas, la monofásica (Psc) se suministra sin el condensador. funcionamiento S1 (si es completamente sumergido) Arranques por hora max. :30

- Brida a norme NEMA, de fundición gris tattada al níquel
- Borne de eje en acero inoxidable Aisi 303
- Camisa externa en acero inoxidable AISI 304
- Cierre mecánico: De cerámica y grafito con protector anti-arena
- Cable de alimentación :1,5 m.
- Conector extraíble impermeable con cierre rápido
- Máxima inmersión 350 m.

BAJO DEMANDA:

- Cuadro de control eléctrico y protección
- Longitud de cable deseado
- Kit de conexión por el cable

6" 50 Hz. Oil	Alimentaz. Feeding	Potenza nominale Nominal power		Corrente assorbita [A] Input current [A]		cos φ (Pf.)	η (Eff.) [%]	Condensatore Capacitor [µF]	S.F. S.F.	Velocità Speed [RPM]	Dimensione cavi - Cable Dimension							
		[kW]	[HP]	I _N	I _{START}						Sez. mm2	4x1,5	4x2,5	4x4	4x6	4x10	4x16	4x25
		Lunghezza max. in metri del cavo dal motore al quadro di comando (caduta di tensione ≤ 3%) Max.cable length in meters from motor to control panel (tension drop ≤ 3%)																
Trifase Three Phase		7.5	10	17.5	81	0.85	78		1.15	2840		50	80	130	200	330	530	8100
		9.2	12.5	21	97	0.82	80		1.15	2870			50	90	130	230	360	550
		11	15	24.1	111	0.83	83		1.15	2860				70	100	170	270	410
		12.8	17.5	27.8	128	0.83	83		1.15	2850					80	140	200	300
		15	20	31.5	145	0.88	82		1.15	2850					80	140	200	300
		18.5	25	41.5	191	0.85	82		1.15	2840					50	100	150	220
		22	30	48	221	0.86	83		1.15	2870						80	120	180
		30	40	62	285	0.86	86		1.15	2860						40	90	130

"INVENTA"



CONVERTITORE DI FREQUENZA ELETTRONICO

Il dispositivo elettronico della serie "INVENTA" è un commutatore di frequenza basato sulla tecnologia ad INVERTER, che tramite il trasduttore di pressione (disponibile a richiesta), regola il numero di giri dell'elettropompa mantenendo costante la pressione impostata al variare della portata richiesta. Regolazione e controllo avvengono tramite tastiera integrata. Il dispositivo può essere integrato sul motore della pompa oppure si può posizionare separatamente su di una parete tramite un pratico supporto.

FUNZIONI PRINCIPALI

- Controllo pressione/portata in base alle necessità dell'impianto
- Protezione pompa contro il surriscaldamento e le variazioni tensioni della linea;
- Arresto della pompa quando l'utilizzo è nullo;
- Comunicazione con altre pompe o dispositivi elettronici secondari (fino a 6 in cascata) senza installazione di una logica di controllo supplementare,
- Compensazione automatica delle perdite di carico causate dall'aumento della portata negli impianti di riscald./condiz

CONVERTISSEUR DE FRÉQUENCE ÉLECTRONIQUE

Le dispositif électronique de la série "INVENTA" est un commutateur de fréquence basé sur la technologie par INVERTER, qui au moyen du transducteur de pression (disponible à la demande), règle le nombre de tours de l'électropompe en maintenant constante la pression programmée malgré la variation du débit demandé. Le réglage et le contrôle se font au moyen du clavier intégré. Le dispositif peut être intégré sur le moteur de la pompe ou être positionné séparément au mur avec un support pratique.

FONCTIONS PRINCIPALES

- Contrôle pression/débit sur la base des nécessités de l'installation
- Protection de la pompe contre la surchauffe et les variations de tension de la ligne ;
- Arrêt de la pompe quand l'utilisation est nulle ;
- Communication avec d'autres pompes ou dispositifs électroniques secondaires (jusqu'à 6 en cascade) sans installation d'une logique de contrôle supplémentaire,
- Compensation automatique des pertes de charge causées par l'augmentation du débit dans les installations de chauff. /condit.

ELECTRONIC FREQUENCY CONVERTER

The electronic device of the series "INVENTA" is a frequency converter based on INVERTER technology, than through the pressure transducers (available at request), permit the speed control of the pump so as keep the constant pressure to varying of the demanded flow. Regulation and control through integrated keyboard. The device could be integrated on the pump's motor or can be installed separately on the wall through a practical support.

MAIN FUNCTIONS



- Pressure/flow Control based on system needs
- Pump protection against the overheating and the variations tensions of feeding.
- Stop of the pump the use when it is null
- Communication with other pumps or secondary electronic devices (till 6 in cascade) without installation of a logic of additional control.
- Automatic compensation of the losses of cargo determinate by the flow increase of the heating /air conditioning systems

CONVERTIDOR DE FRECUENCIA ELECTRÓNICO

El dispositivo electrónico de la serie "INVENTA" es un conmutador de frecuencia basado en la tecnología INVERTER, que a través del transductor de presión (disponible bajo petición), regula el número de giros de la electrobomba manteniendo constante la presión programada no obstante las variaciones del caudal necesario. Su regulación y control se realiza a través de un teclado integrado. El dispositivo puede estar situado en el motor de la bomba o puede colocarse por separado sobre un pared a través de un práctico soporte.

FUNCIONES PRINCIPALES

- Control del presión/caudal según las necesidades de la instalación
- Protección de la bomba contra el recalentamiento y las variaciones de tensión de la línea;
- Parada de la bomba cuando no se utiliza;
- Comunicación con otras bombas o dispositivos electrónicos secundarios (hasta 6 en cascada) sin instalación de una lógica de control supletoria,
- Compensación automática de las pérdidas de carga causadas por el aumento del caudal en los sistemas de calefacción/acondicionamiento.

Cod.	Tipo/Type	Approx. power		 [± 10%]		exited feeling	Max Ass W	Prot. Amp.	Prot. IP	Parete	Base MEC	[kg]
		kW	HP									
293900002	INVENTA 2	1,1-2,2	1,5-3	1~230V	10	3~230V	2200W	16	65	•	80-100	3,5
293900003	INVENTA 3	2,4 - 3	3 - 4	3~400V	8	3~400V	3000W	10	65	•	80-100	3,5
293000040	trasduttore di pressione 0-16bar "keller" Pressure Transducers											

"CDA M"



"CDA T"



■ QUADRI MONOFASE E TRIFASE DI SICUREZZA PER POMPE SOMMERSE CON TRITURATORE

Ingresso rete di alimentazione quadro 1-230V 50/60 Hz monofase (CDA M) : 3-400V 50/60Hz trifase (CDA T)

- Versione monofase CDA M con condensatore disgiuntore da 85 mf
- Predisposizione per galleggiante
- Protezione termica con interruttore reset esterno
- LED spia rossa di allarme
- Interruttore generale ON / OFF
- Rele' termico regolabile (CDA T)
- Pressatavi (2)
- Schema elettrico
- Protezione IP54.

■ SINGLE-PHASE OR THREE-PHASE SAFETY CONTROL PANEL FOR SUBMERSIBLE PUMPS WITH CRUSHING SYSTEM

Input voltage 1-230V 50/60Hz (CDA M) : 3-400V 50/60Hz three-phase (CDA T)

- Single-phase version CDA M with starting capacitor 85 MF
- Predisposed for float switch
- Thermal protection with external reset switch
- Red alarm LED indicator
- main switch ON / OFF
- adjustable thermal protection (CDA T)
- Cable gland nuts (2)
- Electrical diagram
- Protection IP54.

■ COFFRET DE COMMANDE POMPE MONOPHASE ET TRIPHASE POUR ELECTROPOMPE EAUX USEES EQUIPEES D'UN SYSTEME DE DILACERATION



Entrée tension 230V 50/60Hz monophasé (CDA M) : 400V triphasé 50/60 Hz (CDA T)

- Modèlè monophasé con condensateur disjoncteur da 85MF
- Entrée pour la commande par interrupteur de marche a flotteur
- Bouton de réarmement protection)
- Led rouge de alarme
- Bouton pour le fonctionnement moteur ON / OFF
- Protection électronique surcharge de moteur réglable
- Presse-cable
- Protection IP54

■ CUADRO ELETRICOS PARA 1 ELECTROBOMBA SUMERJBLE DE DRENAJE

Entrada red 1-230V 50/60hz monofasica (CDA M) : 3-400V 50/60 hz trifasica (CDA T)

- Versiòn monofàsica con condensador interruptor de circuito 85MF
- Entrada para control desde interruptor de flotador de marcia
- LED royo par alarm (CDA M)
- Protecciòn de sorbergada del motor regulable (CDA T)
- Botones de reiniciaciòn de la protecciòn
- Interuptor de ENCENDIDO / APAGADO
- Salida con prensacables antidesgarro
- Grado de protecciòn IP 54

Cod.	Tipo/Type	Approx. power		 [± 10%]		Reg. Prot. Termica Amp. Thermal Amp. Prot.	Prot. IP	Dimensioni/Dimensions			[kg]
		kW	HP					a	b	c	
293540150	CDA M 150	1,1	1,5	1~230V	85	10 A	54	180	100	120	0,5
293540151	CDA T 150	1,1	1,5	3 ~400V	-	2A - 3A	55	180	100	120	0,5
293540200	CDA T 200	1,47	2	3 ~400V	-	3A - 4A	55	160	150	85	0,5

"CBX"



■ QUADRI MONOFASE PER POMPE SOMMERSE

Quadro elettromeccanico monofase con condensatore di marcia, termico e interruttore luminoso: adatti per il comando di una elettropompa sommersa monofase.

- Predisposizione dei contatti interni per comando da pressostato o interruttore a galleggiante esterni
- Protezione termica con interruttore reset esterno
- Interruttore generale luminoso 0 - I
- Involucro termoplastico
- Pressacavi (2)
- Schema elettrico
- Protezione IP 54

■ SINGLE-PHASE CONTROL PANEL FOR SUBMERSIBLE PUMPS

Electromechanical single-phase control panel with capacitor of run, thermal protection and luminous switch, for one single phase electric pump.

- Predisposed internal connection for external pressure switch or float switch
- Thermal protection with external reset switch
- Luminous main switch 0 - I
- Thermoplastic box
- Cable gland nuts (2)
- Electrical diagram
- Protection IP 54

■ COFFRET DE COMMANDE POMPE MONOPHASE SUMERSIBLE



Coffret électromécanique monophasé avec le condensateur de marche' e protection thermique, est particulièrement adapté pour pompe sumersible

- Entrée tension 230V 50/60Hz monophasé
- Predisposition pour la pression extérieure ou interrupteur à flotteur
- Bouton de réarmement protection
- Coffret en abs
- Bouton pour le fonctionnement moteur ON / OFF
- Presse-cable
- Schéma de câblage
- Protection IP 54

■ CUADRO ELETRICOS MONOFASICO PARA 1 ELECTROBOMBA SUMERGIDA

Cuadro eletricos monofásico con condensator de marcia e proteton termica, es particularmente adecuado para el control de una bomba sumergible

- Entrada red 1-230V 50/60hz monofásicos
- Preparación para el comando desde presostato o interruptor de flotador de marcia

Cod.	Tipo/Type	Approx. power		 [± 10%]		Reg. Prot. Termica Amp.	Prot.	Dimensioni/Dimensions			[kg]
		kW	HP			Thermal Amp. Prot.		IP	a	b	
293500050	CBX 50	0,37	0,5	1~230V	20	4 A	50	160	160	70	0,5
293500075	CBX 75	0,55	0,75	1~230V	25	6 A	50	160	160	70	0,5
293500100	CBX 100	0,75	1	1~230V	30	8 A	50	160	160	70	0,7
293500150	CBX 150	1,1	1,5	1~230V	40	10 A	50	160	160	70	0,7
293500200	CBX 200	1,5	2	1~230V	45	16 A	50	160	160	70	0,8
293500300	CBX 300	2,2	3	1~230V	75	18 A	50	160	160	70	1

"CBX 05/300" "CBT"



■ QUADRI MONOFASE E TRIFASE PER POMPE SOMMERSE CON CONTROLLO MARCIA A SECCO

Quadri elettronici con display di comando e protezione elettronica dello protezione di 5"

- Ingresso rete alimentazione quadro 1-230V 50/60Hz monofase CBX 05/300: 3-400V 50/60 Hz trifase CBT • Ingresso in bassissima tensione per comando da pressostato o interruttore a galleggiante
- Pulsante per il funzionamento del motore in AUT/O/MAN (manuale momentaneo) • LED spia verde di funzionamento motore / in automatico • Display multifunzione per la visualizzazione di: tensione rete, corrente motore, COS ϕ motore ed allarmi • Pulsanti di ripristino protezione e, programmazione display • Protezione elettronica per sovraccarico motore regolabile (da tastiera) • Protezione motore per errata sequenza fasi (CBT) e per MIN. / MAX. tensione • Tempo di intervento protezione di 5"
- Protezione di marcia a secco regolabile da COS ϕ 0,1÷0,9 (da tastiera) • Ripristino automatico della protezione marcia a secco regolabile da 5'-30'-60'-90 • Selettore interno per ripristino automatico marcia a secco ogni 90" • Fusibile di protezione circuito ausiliario e del motore • Predisposto per l'inserimento del condensatore (CBX 05/300) • Interruttore On-Off • Pressacavi • Protezione IP55

■ SINGLE-PHASE OR TREE-PHASE CONTROL PANEL WITH CONTROL FOR DRY RUNNING

Electronic control panel with display for submersible electric pump for dry running protection without level probes.

- Input voltage 1-230V 50/60Hz single-phase CBX 05/300: 3-400V 50/60 Hz tree-phase CBT • Very low voltage input for external pressure switch or float switch • Push-buttons for AUT/O/MAN motor operation (manual temporary) • Green LED for AUTO operation / motor operating • Multifunction display for the visualization of: voltage, motor current, motor COS ϕ and alarms • Push-buttons for protection restoration and for adjustments and set up from the display • Adjustable electronic protection for motor overload (from keyboard) • Time for activation of protection: 5" • Dry running protection adjustable from COS ϕ 0,1÷0,9 (from keyboard) • Automatic restoration from dry running after 5'-30'-60'-90" • Internal selector for automatic restoration from dry running every 90" • Motor protection of wrong phase sequence (CBT) and of MIN. / MAX. voltage • Auxiliary circuits protection fuse and motor • Predisposed for capacitors' insertion (CBX 05/300) • On-Off switch • Cable gland nuts • Protection IP55

■ COFFRET DE COMMANDE POMPE SUBMERSIBLE MONOPHASE ET TRIPHASE AVEC CONTROL AU FONCTIONNEMENT A SEC



Coffret électronique avec display de commande et protection électronique de fonctionner à sec pour une pompe submersible sans l'utilisation de sondes.

- Entrée sous tension 230V 50/60Hz monophasé CBX05/300: 400V triphasé 50/60 Hz CBT • Entrée en très basse tension pour la pression extérieure ou interrupteur à flotteur • Bouton pour le fonctionnement moteur AUT/O/MAN (manuel momentané) • Led vert de fonctionnement du moteur indicateur / automatique • Display multifonction pour la visualisation: tension, courant du moteur, et d'alarme COS ϕ • Boutons de réarmement protection et programmation display • Protection électroniques surcharge de moteur réglable (dans le display) • Protection du moteur pour la séquence de phase incorrecte (CBT) et MIN. / MAX. tension • Temps pour intervention protection de 5" sec. • fonctionnement à sec réglable de COS ϕ 0,1 à 0,9 (dans le display) • Réarmement automatique de protection contre le fonctionnement à sec réglable de 5'-30'-60'-90 • Sélecteur interne pour réarmement automatique de marche à sec chaque fois a 90sec. • Fusible protection du circuit et moteur • Predisposition pour l'insertion d'un condensateur (CBX 05/300) • Selectionneur général avec verrouillage porte • Presse-cable • IP55

■ CUADRO MONOFASICAS O TRIFASICAS POR ELECTROBOMBAS SUMERGIDAS CON EL CONTROL DE EL FUNCIONAMIENTO EN SECO

Cuadro electrónico con display de comando e protección electrónica del funcionamiento en seco para 1 electrobomba sumergible sin la utilización de sondas de nivel

- Entrada red cuadro 1-230V 50/60Hz monofasica CBX 05/300 : 3-400V 50/60 Hz trifasica CBT • Entrada con tensión muy baja para controlar desde presotato o intrruptor de flotador • Botones funcionamiento motor en AUT/O/MAN (manual momentáneo) • LED piloto verde de funcionamiento en automático/funcionamiento • Display multifunción para la visualización de: tensión de red, corriente motor, COS ϕ motor y alarmas • Botones de reiniciación de la protección e de programación de display • Protección electrónica de sorbergada del motor regulable (desde el teclado) • Protección motor por la erronea secuencia de las fasas (CBT) e par la MIN / MAX tensión • Tempo de intervenció de la protección 5" • Protección de funcionamiento en seco regulable desde COS ϕ 0,1÷0,9 (desde el teclado) • Reiniciación automática de la protección del funcionamiento en seco después de 5'-30'-60'y 90" • Selector interno parala reiniciación automática de funcionamiento en seco cada 90" • Fusible de protección del motor e de los auxiliares • Preparada para la ativación del condensador (CBX 05/300) • Seccionador general con bloqueador de puerta • Salida con presnascables antidesgarro • Grado de protección IP 55

Cod.	Tipo/Type	Approx. power		 [$\pm 10\%$]		Reg. Prot. Termica Amp.		Prot. IP	Dimensioni/Dimensions			[kg]
		kW	HP			Thermal Amp. Prot.			a	b	c	
293520050	CBX 05/300	0,37-2,2	0,5-3	1~230V	-	2	16	55	340	240	170	1,5
293520075	CBT 08/750	0,55-3,7	0,75-5,5	3 ~400V	-	2	8	55	280	200	130	2
293520080	CBT 08/1000	0,55-7,5	0,75-10	3 ~400V	-	2	15	55	340	240	170	3
293520100	CBT 1000/1500	7,5-11	10-15	3 ~400V	-	16	24	55	340	220	170	3

"CB2X"

"CB2T"



■ QUADRI MONOFASE O TRIFASE DI PRESSURIZZAZIONE PER GRUPPI A DUE POMPE

Ingresso rete di alimentazione quadro 1-230V 50/60hz monofase CB2X: 3-400V 50/60 Hz trifase CB2T

- Ingresso in bassissima tensione per comando da 2 presso stati o interruttori a galleggiante con sistema anti rimbalzo e per comando da esterno di galleggiante o pressostato di minima
- Circuito di alternanza pompe con ritardo di 4" tra la partenza delle due pompe
- Possibilità di escludere la pompa in avaria
- Selettore interno per escludere alternanza pompe
- 2 pulsanti per funzionamento motori AUT/O/MAN (manuale temporaneo)
- LED spia verde presenza rete ,funzionamento in automatico, e motore in funzione
- 2LED spia rossa di allarme motori in protezione per sovraccarico e di allarme livello acqua
- Protezione elettronica per sovraccarico motori regolabile
- Tempo di intervento protezione 5"
- Pulsanti di ripristino protezione
- Uscita allarme con contatti di scambio 5A 250V
- Fusibile di protezione ausiliari e protezione motore
- Sezionatore generale bloccoporta
- Protezione IP 55.

■ COFFRET DE COMMANDE DE 2 ELECROPOMPES MONOPHASE ET TRIPHASE DE PRESURISATION

Entrée sous tension 230V 50/60Hz monophasè CB2X: 400V triphasè 50/60 Hz CB2T

- Entrée en très basse tension pour la comande de 2 pression extérieure ou interrupteur à flotteur avec système anti-rebond e pour commande extérieure à partir d'un presostat ou d'un interrupteur à flotteur de minimum
- Circuit d'alternance pompes incorporé avec retard de 4" entre la démarrage des deux pompes
- Possibilité de désactivation pompe en avarie
- Sélecteur interne pour désactivation alternance pompes
- 2 Bouton pour le fonctionnement moteur AUT/O/MAN (manuel momentané)
- 2 Led vert de présence réseau ; fonctionnement du moteur; de indicateur de fonctionnement en automatique
- 2 Led rouge pour alarme moteur protégé contre le surcharge e d'alarme niveau eau
- Boutons de réarmement protection
- Protection électroniques surcharge de moteur réglable
- Temps pour intervention protection de 5 " sec.
- Sortie alarme avec contacts inverseurs 5A 250V (charge résistive)
- Fusible protection du circuit et moteur
- Selectionneur général avec verrouillage porte
- Presse-cable
- Protection IP55

■ SINGLE-PHASE OR THREE-PHASE CONTROL PANEL FOR 2 PUMPS BOOSTER SET PUMPS



Input voltage 1 - 230V 50/60 hz single-phase CB2X: 3-400V 50/60 Hz three-phase CB2T

- Very low voltage input for 2 external pressure switches or 2 float switches with anti-bouncing system and for external minimum level pressure swiches or float swuches
- Pumps' exchanger circuit with 4" delay between the starts of the 2 pumps
- Possibility to exclude a damaged pump
- Internal selector for exclusion of pumps exchanger
- Selectors for AUTO/O/MAN motor operation (manual temporary)
- Green LED for power on ; auto operation and motors operating
- 2 red LED for overload motor protection alarm adjustable motors overload electronic protection and water level
- Time for protection activation 5"
- Push-buttons for restoration from protection
- Alarm output with exchangeable contacts 5A 250v (resistive load)
- Auxiliary circuits protection fuse and motor protection fuse
- Main switch with door interlock
- Protection IP55.

■ CUADRO MONOFASICAS O TRIFASICAS POR EL CONTROL DE PRESION PARE 2 ELECTROBOMBAS

Entrada red 1-230V 50/60hz monofasicàs CB2X : 3-400V 50/60 Hz trifasicàs CB2T

- Entrada con tensión muy baja para 2 controlar desde presotatos o interruptors de flotador con sistema "anti-rebote"; control externo desde presostat o flotador de minima
- Posibilidad de exclusión de la bomba averiada
- Selector interno para la exclusión de la alternancia de la bombas
- Circuito de alternancia de las bombas incorporado con un retraso de 4" entre el arranque de la dos bombas
- Botones funcionamiento motor en AUT/O/MAN (manual momentáneo)
- 2 LED piloto verde de funcionamiento en automático / motor funcionando
- 2 LED piloto royo par alarm motote in proteccìon por sobrecarga; de alarm nivel agua
- Protección eletrònica de sorbergada del motor regulabile
- Tempo de intervencìon de la proteccìon 5 "
- Botones de reiniciaciòn de la proteccìon
- Salida alarma con contactos en iterscambio 5A 250V
- Fusible de proteccìon del motor e de los auxiliares
- Seccionador general con bloqueador de puerta
- Salida con presacables antidesgarro
- Grado de proteccìon IP 55

Cod.	Tipo/Type	Approx. power		 [± 10%]		Reg. Prot. Termica Amp.		Prot. IP	Dimensioni/Dimensions			[kg]
		kW	HP			Thermal Amp. Prot.	a		b	c		
293620300	CB2X 05/300	0,37-2,2	0,5-3	1~230V	-	2	16	55	220	170	340	3
293620551	CB2T 75/400	0,55-3,7	0,75-5,5	3 ~400V	-	2	8	55	340	240	170	4,5
293620554	CB2T 75/750	0,5/7,5	0,75-10	3 ~400V	-	6	15	55	340	240	170	4,5
293621000	CB2T 1000/1250	7,5-11	10-15	3 ~400V	-	16	24	55	420	300	150	5,5

"CBS"



■ QUADRI TRIFASE STELLA - TRIANGOLO

Quadro elettromeccanico di comando e protezione termica per avviamento pompe con collegamento stella triangolo.

- Ingresso rete di alimentazione 3-400V 50/60Hz trifase
- Ingresso in bassissima tensione per comando da pressostato o interruttore a galleggiante
- Ingresso per comando da pressostato o galleggiante contro la marcia secco
- Trasformatore 400/24 V per circuiti ausiliari
- 1 selettore per il funzionamento del motore in AUT/O/MAN
- Luce spia blu di presenza rete
- Luce spia verde di motore in funzione
- Luce spia rossa di allarme motore in protezione
- Contattore di linea 400V dimensionato in AC3
- Contattore di stella 400V dimensionato in AC3
- Contattore di triangolo 400V dimensionato in AC3
- Temporizzazione scambio regolabile 0÷30"
- Relais termico protezione sovraccarico ripristinabile internamente
- Fusibile di protezione motore
- Fusibile di protezione circuito ausiliario
- Morsettiera collegamento galleggianti/pressostati
- Sezionatore generale con blocco-porta
- Pressacavi
- Protezione IP55.

■ COFFRET DE COMMANDE TRIPHASE ETOILE - TRIANGLE

Coffret électro-mécaniques et de protection thermique pour le démarrage des pompes avec étoile-triangle.

- Alimentation d'entrée 3-phase 400v 50/60 Hz
- Entrée en très basse tension pour les pressions extérieures ou interrupteur à flotteur
- Entrée de la pression extérieure ou un flotteur contre la marche à sec
- Transformateurs 400/24 V pour auxiliaires
- 1 interrupteur pour actionner le moteur en AUT/O/MAN
- Lumière bleu de présence réseau
- Lumière vert pour la fonction moteur
- Lumière rouge d'alarme de protection moteur
- Contacteur de ligne en 400V AC3
- Contacteur étoile en 400V AC3
- Contacteur triangle en 400V AC3
- Temporizzazione échange réglable de 0 à 30 "
- relais internes de protection à réarmement thermique
- Fusible protection du circuit et moteur
- Bornes groupement interrupteur à flotteur ou de la pression
- Sectionneur général avec verrouillage porte
- Glandes
- Protection IP55.

■ STAR - DELTA START CONTROL PANEL



Electromechanical control panel for pumps with star-delta starting & thermal protection.

- Input voltage 3-400V 50/60hz three-phase
- Very low voltage input for external pressure switch or float switch
- Low voltage input for external float switch for dry running protection
- 400/24 V transformer for auxiliary circuits 1 selector for AUTOMATIC/OFF/MANUAL operation
- Blue power on LED indicator
- Green motor operating LED indicator
- Red motor protection LED indicator
- Line contactors 400V planned in AC3
- Delta contactors 400V planned in AC3
- Star contactors 400V planned in AC3
- Adjustable delta/star timer 0÷30"
- Thermal protection with external reset switch
- Motor protection fuse
- Auxiliary circuits protection fuse
- Board connector for pressure / float switches and motor
- General disconnecting switch with door interlock
- Cable gland nuts
- Protection IP55.

■ CUADRO TRIFASICO POR EL CONTROL DE PRESION PARE 1 ELECTROBOMBAS CON ESTELA - TRIANGULO

Cuadro de control y la protección electro-mecánico par 1 electobomba de superficie trifásicas con estrella-triángulo

- Entrada red 3 fases 400V 50/60Hz
- Entrada con tensión muy baja para controlar desde presostatos o interruptores de flotador
- Entrada para los presostatos o interruptor de flotador contra el funcionamiento en seco
- Transformadores 400/24V para auxiliares
- Interruptores para el funcionamiento del motor en AUTO/O/MAN
- Azul Luz para la energía
- Luz verdes para motor en marcha
- Luz rojas de alarma de protección del motor
- Contactor de línea de 400V AC3
- Contactor estrellas contactor en AC3 400V
- Contactor de triángulo en 400V AC3
- Cambio ajustable 0-30 de tiempos "
- Protección contra la sobrecarga reinicial interna
- Fusibles de protección de motores e auxiliar
- Seccionador general con bloqueador de puerta
- Conexión de terminales interruptores / flotadores
- Interruptor de encendido y apagado
- Cable glándulas
- Grado de protección IP55

Cod.	Tipo/Type	Approx. power		 [± 10%]		Reg. Prot. Termica Amp.		Prot. IP	Dimensioni/Dimensions			[kg]
		kW	HP			Thermal Amp.	Prot.		a	b	c	
293530100	CBS 1000	7,5	10	3 ~400V	-	10	16	55	420	320	170	6
293530150	CBS 1500	11	15	3 ~400V	-	15	20	55	420	320	170	6
293530200	CBS 2000	15	20	3 ~400V	-	24	31	55	530	400	230	16
293530250	CBS 2500	18,5	25	3 ~400V	-	24	36	55	530	400	230	16
293530300	CBS 3000	22	30	3 ~400V	-	34	50	55	530	400	230	16
293530400	CBS 4000	30	40	3 ~400V	-	48	62	55	530	400	230	20

"CB2S"



QUADRI TRIFASE STELLA - TRIANGOLO PER GRUPPI A DUE POMPE

Quadro elettromeccanico di comando e protezione per 2 elettropompe trifase di superficie con avviamento stella triangolo

- Ingresso rete di alimentazione 3-400V 50/60hz trifase
- Ingresso in bassissima tensione per comando da pressostati o interruttori a galleggiante
- Ingresso per comando da pressostato o galleggiante contro la marcia a secco
- Trasformatore 400/24V per circuiti ausiliari
- 2 selettori per il funzionamento del motore in AUTO/0/MAN
- Luce spia blu di presenza rete
- 2 luci spia verdi di motore in funzione
- 2 Luci spia rossa di allarme motore in protezione
- 2 Contattori di linea 400V dimensionato in AC3
- 2 Contattori di stella 400V dimensionato in AC3
- 2 Contattori di triangolo 400V dimensionato in AC3
- 2 Temporizzazione scambio regolabile 0÷30"
- 2 relè termici protezione sovraccarico ripristinabili internamente
- Fusibili di protezione motori
- Fusibile di protezione ausiliari
- Sezionatore generale con blocco-porta
- Morsettiera collegamento pressostati/galleggianti
- Interruttore On-Off
- Pressatavi
- Protezione IP55.

COFFRET DE COMMANDE TRIPHASE ETOILE - TRIANGLE DE PRESURISATION

Coffret électro-mécaniques et de protection thermique pour le démarrage des 2 pompes de pressurisation avec étoile-triangle.

- Alimentation d'entrée 3-phase 400v 50/60 Hz
- Entrée en très basse tension pour les pressions extérieures ou interrupteur à flotteur
- Entrée de la pression extérieure ou un flotteur contre la marche à sec
- Transformateurs 400/24 V pour auxiliaires
- 2 interrupteur pour actionner le moteur en AUT/0/MAN
- Lumière bleu de présence réseau
- 2 Lumière vert pour la fonction moteur
- 2 Lumière rouge d'alarme de protégé moteur
- 2 Contacteur de ligne en 400V AC3
- 2 Contacteur étoile en 400V AC3
- 2 Contacteur triangle en 400V AC3
- 2 Moment d'échange réglable de 0 à 30 "
- 2relais internes de protection à réarmement thermique
- Fusible protection du circuit et moteur
- Bornes groupement interrupteur à flotteur ou de la pression
- Seccionneur général avec verrouillage porte
- Glandes
- Protection IP55.

THREE-PHASE STAR - DELTA CONTROL PANEL FOR 2 PUMPS BOOSTER SET



Electromechanical control panel for 2 three-phase surface pumps with star-delta starting

- Input voltage 3-400V 50/60hz three-phase
- Very low voltage input for external pressure switches or float switches
- Very low voltage input for external float switch for dry running protection
- 400/24V transformer for auxiliary circuit
- 2 selectors for AUTO-OFF-MANUAL motor operation
- Blue power on LED
- 2 green motor operating LED's
- 2 Red motor protection LED's
- 2 Line contactors 400V planned in AC3
- 2 Delta contactors 400V planned in AC3
- 2 Star contactors 400V planned in AC3
- 2 adjustable delta/star timer 0÷30"
- 2 Thermal protection with external reset switch
- Motor protection fuses
- Auxiliary circuits protection fuse
- General disconnecting switch with door interlock
- Clip connector for pressure /float switches and motor
- On-Off switch
- Cable gland nuts
- Protection IP55.

CUADRO TRIFASICAS POR EL CONTROL DE PRESION PARE 2 ELECTROBOMBAS CON ESTELA - TRIANGULO

Quadro de control y la protección electro-mecánico por dos electobombas de superficie trifásicas con estrella-triángulo

- Entrada red 3 fases 400V 50/60Hz
- Entrada con tensión muy baja para 2 controlar desde presostatos o interruptores de flotador
- Entrada para los presostatos o interruptor de flotador contra el funcionamiento en seco
- Transformadores 400/24V para auxiliares
- 2 interruptores para el funcionamiento del motor en AUTO/0/MAN
- Azul Luz para la energía
- 2 luces verdes para motor en marcha
- 2 luces rojas de alarma de protección del motor
- 2 contactores de línea de 400V AC3
- 2 estrellas contactor en AC3 400V
- 2 Contactores de triángulo en 400V AC3
- 2 de cambio ajustable 0-30 de tiempos "
- 2 protección contra la sobrecarga reiniciable internos
- Fusibles de protección de motores e auxiliar
- Seccionador general con bloqueador de puerta
- Conexión de terminales interruptores / flotadores
- Interruptor de encendido y apagado
- Cable glándulas
- Grado de protección IP55

Cod.	Tipo/Type	Approx. power		 [± 10%]		Reg. Prot. Termica Amp.		Prot. IP	Dimensioni/Dimensions			[kg]
		kW	HP			Thermal Amp.	Prot.		a	b	c	
293631500	CB2S 1500	11	15	3 ~400V	-	15	20	55	630	400	230	12
293632000	CB2S 2000	15	20	3 ~400V	-	24	31	55	690	500	230	32
293632500	CB2S 2500	18,5	25	3 ~400V	-	24	36	55	840	600	280	40
293633000	CB2S 3000	22	30	3 ~400V	-	34	50	55	840	600	280	40

"CBR" "CBRT"



■ QUADRO DI COMANDO ELETTRONICO PER ELETTROPOMPE MONOFASE O TRIFASE SOMMERSE PER DRENAGGIO

Ingresso rete di alimentazione 1-230V 50/60 Hz monofase CBR : 3-400V 50/60Hz trifase CBRT

- Ingresso in bassissima tensione per comando da interruttore a galleggiante di arresto; per comando da interruttore a galleggiante di marcia; per comando da interruttore a galleggiante di allarme livello max; per klikson motore
- Pulsanti di funzionamento motore in AUT/O/MAN (manuale momentaneo)
- LED spia verde presenza rete; di motore in funzione e di funzione in automatico
- LED spia rossa di allarme motore in protezione per sovraccarico; di allarme livello acqua e di allarme intervento klikson
- Pulsante di ripristino protezione
- Protezione elettronica per sovraccarico motore regolabile con tempo di intervento di 5"
- Fusibili di protezione ausiliari e protezione motore
- Uscita allarme con contatti di scambio 5A 250 V (carico resistivo)
- Predisposto per l'inserimento del condensatore (CBR)
- Sezionatore generale con bloccoporta
- Protezione IP 55.

■ ELECTRONIC CONTROL PANEL FOR SINGLE-PHASE OR THREE-PHASE SEWAGE PUMP

Input voltage 1-230V 50/60 Hz single-phase CBR: 3-400V 50/60 Hz tree-phase CBT

- Very low voltage input for float switch of stop; for float switch of start; for max level alarm float switch; for klikson motor
- Push-buttons for AUTO-OFF-MANUAL motor operation (manual temporary)
- Green LED for power on; for motor operating; for auto operation
- Red LED for water level alarm; for overload motor protection alarm; for alarm motor's klikson active
- Push button for restoration from protection
- Adjustable electronic protection for motor overload, activation of protection 5"
- Auxiliary circuits and motor protection fuses
- Single-phase model adapted for the insertion of a capacitor (CBR)
- Alarm output with exchangeable contacts 5A 250 V (resistive load)
- Main switch with door interlock
- Protection IP55

■ COFFRET DE COMMANDE POMPE MONOPHASE ET TRIPHASE POUR ELECTROPOMPE EAUX USEES



Entrée sous tension 230V 50/60 Hz monophasé CBR : 400V triphasé 50/60 Hz CBRT

- Entrée en très basse tension pour la commande par interrupteur d'arrêt a flotteur ; par interrupteur de marche a flotteur ; par interrupteur d'alarme niveau max a flotteur ; pour klikson moteur
- Bouton pour le fonctionnement moteur AUT/O/MAN (manuel momentané)
- Led vert de présence réseau ; fonctionnement du moteur ; de indicateur de fonctionnement en automatique
- Led rouge pour alarme moteur protégè contre le surcharge ; d'alarme niveau eau ; intervention kliksons moteurs
- Boutons de réarmement protection
- Protection électroniques surcharge de moteur réglable
- Temps pour intervention protection de 5" sec.
- Sortie alarme avec contacts inverseurs 5A 250V (charge résistive)
- Fusible protection du circuit et moteur
- Selectionneur gènèral avec verrouillage porte
- Presse-cable
- Protection IP55

■ CUADRO ELETRICOS PARA 1 ELECTROBOMBA SUMERJBLE DE DRENAJE

Entrada red 1-230V 50/60 Hz monofasica CBR: 3-400V 50/60 Hz trifasica CBRT

- Entrada con tension muy baja para control desde intrruptor de flotador de marcia; control esterno desde flotador de aresto; control esterno desde flotador de maxima; control esterno por klikson motore
- Botones funcionamiento motor en AUT/O/MAN (manual momentáneo)
- LED piloto verde de funcionamiento en automatico / motore funcionando
- LED piloto royo par alarm motote in proteccion por sobrecarga; de alarm nivel agua; de intervento klikson motore
- Proteccion eletrónica de sorbergada del motor regulabile
- Tempo de intervencion de la proteccion 5"
- Botones de reiniciacion de la proteccion
- Salida alarma con contactos en iterscambio 5A 250V
- Fusible de proteccion del motor e de los auxiliares
- Seccionador general con bloqueador de puerta
- Salida con prensacables antidesgarro
- Grado de proteccion IP 55

Cod.	Tipo/Type	Approx. power		 [± 10%]		Reg. Prot. Termica Amp.		Prot. IP	Dimensioni/Dimensions			[kg]
		kW	HP			Thermal Amp.	Prot.		a	b	c	
293550300	CBR 05/300	0,37-2,2	0,5 - 3	1~230V	-	2	16	55	340	240	170	1,5
293550700	CBRT 08/750	0,55-5,5	0,75-7,5	3 ~400V	-	2	11	55	340	240	170	2
293551000	CBRT 08/1000	0,55-7,5	0,75-10	3 ~400V	-	2	15	55	340	240	170	3
293551500	CBRT 1000/1500	7,5-11	10-15	3 ~400V	-	16	24	55	340	220	170	3

"CB2R"

"CB2RT"



■ QUADRO DI COMANDO ELETTRONICO PER 2 ELETTROPOMPE MONOFASE O TRIFASE SOMMERSE PER DRENAGGIO

- Ingresso rete di alimentazione quadro 1-230V 50/60hz monofase CB2R: 3- 400V 50/60 hz trifase CB2RT
- Ingresso in bassissima tensione per comando di 2 interruttori a galleggiante di marcia; per comando da interruttore a galleggiante di arresto; per comando da interruttore a galleggiante di livello max; per klicson motori
- Circuito di alternanza pompe incorporato con ritardo di 4" tra la partenza delle due pompe
- Selettore interno per esclusione alternanza pompe
- Possibilità di escludere la pompa in avaria
- 2 pulsanti per il funzionamento AUT/O/MAN (manuale momentaneo)
- Fusibili di protezione circuiti ausiliari e protezione motori
- Protezione elettronica per sovraccarico motori regolabile, con tempo di intervento di 5"
- LED spia verde presenza rete ; di motore in funzione e di funzionamento in automatico
- 2 LED spia rossa di allarme motori in protezione per sovraccarico; di allarme livello acqua; di allarme intervento klicson
- 2 pulsanti di ripristino protezioni
- Uscita di allarme con contatti di scambio 5° 250V (carico resistivo)
- Versione monofase predisposta per l'inserimento dei condensatori
- Pulsanti di ripristino protezione
- Sezionatore generale bloccoporta
- Protezione IP55

■ ELECTRONIC CONTROL PANEL FOR 2 SINGLE-PHASE OR THREE-PHASE SEWAGE PUMPS



- Input voltage 1-230V 50/60 hz single-phase CB2R: 3-400V 50/60 hz three-phase CB2RT
- Very low voltage input for float switch of stop; for 2 float switch of start; for max level alarm float switch; for 2 klicson motor
- Pumps' exchanger circuit with 4" delay between the starts of the 2 pumps
- Possibility to exclude a damaged pump
- Internal selector for exclusion of pumps' exchanger
- Push-buttons for AUTO-OFF-MANUAL motor operation (manual temporary)
- Green LED for power on; for motor operating; for auto operation.
- Red LED for water level alarm ; for overload motor protection alarm ; for alarm motor's klicson active
- 2 Push button for restoration from protection
- Adjustable electronic protection for motor overload; activation of protection 5"
- Auxiliary circuits protection fuses and motor protectoin
- Alarm output with exchangeable contacts 5A 250 V (resistive load)
- Adapted for the insertion of a capacitor
- button to reset protection
- Main switch with door interlock
- Protection IP55

■ COFFRET DE COMMANDE POMPE MONOPHASE ET TRIPHASE POUR 2 ELECTROPOMPES EAUX USEES

- Entrée sous tension 230V 50/60Hz monophasé CB2R : 400V triphasé 50/60 Hz CB2RT
- Entrée en très basse tension pour la commande par interrupteur d'arrêt a flotteur ; par 2 interrupteurs de marche a flotteur ; par interrupteur d'alarme niveau max a flotteur ; pour 2 klicson moteurs
- Circuit d'alternance pompes incorporé avec retard de 4" entre la démarrage des deux pompes
- Possibilité de désactivation pompe en avarie
- Sélecteur interne pour désactivation alternance pompes
- 2 Bouton pour le fonctionnement moteur AUT/O/MAN (manuel momentanée)
- 2 Led vert de présence réseau ; fonctionnement du moteur ; de indicateur de fonctionnement en automatique
- 2 Led rouge pour alarme moteur protégé contre le surcharge ; d'alarme niveau eau ; intervention klicsons moteurs
- 2 Boutons de réarmement protection
- Protection électroniques surcharge de moteur réglable
- Temps pour intervention protection de 5 " sec.
- Sortie alarme avec contacts inverseurs 5A 250V (charge résistive)
- Fusible protection du circuit et moteur
- Selectionneur général avec verrouillage porte
- Presse-cable
- Protection IP55

■ CUADRO ELETRICOS PARA 2 ELECTROBOMBAS SUMERJBLES DE DRENAJE

- Entrada red 1-230V 50/60hz monofasica CB2R: 3- 400V 50/60 hz trifasica CB2RT
- Entrada con tensión muy baja para 2 control desde interruptors de flotador de marcia; control externo desde flotador de arresto; control externo desde flotador de maxima; control externo por klicson motores
- Posibilidad de exclusión de la bomba averiada
- Selector interno para la exclusión de la alternancia de la bombas
- Circuito de alternancia de las bombas incorporado con un retraso de 4" entre el arranque de la dos bombas
- Botones funcionamiento motor en Automatico-Apagado-Manual (manual momentáneo)
- 2 LED piloto verde de funcionamiento en automático / motore funcionando
- 2 LED piloto royo par alarm motote in proteccion por sobrecarga; de alarm nivel agua; de intervento klicson motore
- Protección eletrónica de sorbergada del motor regulabile
- Tempo de intervección de la protección 5 "
- Botones de reiniciación de la protección
- Salida alarma con contactos en iterscambio 5A 250V
- Fusible de protección del motor e de los auxiliares
- Seccionador general con bloqueador de puerta
- Salida con prensacables antidesgarro
- Grado de protección IP 55

Cod.	Tipo/Type	Approx. power		 [± 10%]		Reg. Prot. Termica Amp.		Prot.	Dimensioni/Dimensions			[kg]
		kW	HP			Thermal Amp. Prot.	IP		a	b	c	
293650300	CB2R 05/300	0,37-2,2	0,5-3	1~230V	-	2	16	55	340	240	170	3
293650700	CB2RT 08/400	0,55-3,7	0,75-5,5	3 ~400V	-	2	8	55	340	240	170	4,5
293651000	CB2RT 08/750	0,55-7,5	0,75-10	3 ~400V	-	2	15	55	340	240	170	4,5
293651500	CB2RT 1000/1500	7,5-11	10-15	3 ~400V	-	16	24	55	420	300	150	5,5

Electric pumps

"KIT PRESS"



KIT DI PRESSURIZZAZIONE

- Basamento completo di asta e piastra porta quadro
- Collettori di aspirazione
- Valvola di ritegno, valvola sezionatrice ed attacco per eventuali alimentatori d'aria in aspirazione a ciascuna pompa
- Collettore di mandata con attacchi per pressostati, manometro ed eventuali autoclavi verticali a membrana
- Valvola sezionatrice in mandata a ciascuna pompa
- Manometro

PRESSURE SYSTEM KIT

- Base frame complete of bar and plate for control panel
- Suction manifold
- Check valve, ball valve and connection for possible air feedings in suction to each pump
- Outlet manifold with connections for pressure switch, pressure gauge and eventual vertical pressure tanks
- Outlet ball valve on each pump
- Pressure gauge

KIT DE PRESSURISATION

- Socle muni d'une barre et d'une plaque porte panneau
- Collecteurs d'aspiration
- Clapet de non-retour, vanne de sectionnement et prise pour d'éventuels alimentateurs d'air en aspiration à chaque pompe
- Collecteur de refoulement avec prises pour pressostats, manomètre et éventuels autoclaves verticaux à membrane
- Vanne de sectionnement en refoulement à chaque pompe
- Manomètre

KIT DE PRESURIZACIÓN

- Base con asta y placa porta-cuadro incluidas
- Colectores de aspiración
- Válvula de retención, válvula de corte y acometida para eventuales alimentadores de aire en aspiración en cada bomba
- Colector de descarga con acometidas para presostatos, manómetro y eventuales autoclaves verticales de membrana
- Válvula de corte en descarga para cada bomba
- Manómetro

TIPO/TYPE	Collettori Manifold aspirazione / suction		Riduzioni Reductions	Collettori / Manifold Mandata / Outlet		Tipo di Gruppo eseguibile Pressure System Feasible Type
	DNA	DNAP		DNM	DNMP	
Kit Press A	1"1/2	1"	0	1"1/2	1"	TP2-MK - Jet - K - MJ - MJX - BK100
Kit Press B	2"	1"1/4	0	1"1/2	1"	TP2 - K 150÷300
Kit Press C	2"	1"1/4	0	2"	1"1/4	TP2-Verti Line
Kit Press D	2"	1"1/4	0	2"	1"1/4	TP2-Verti
Kit Press F	2"1/2	1"1/2	0	1"1/2	1"	TP2-BK 150÷300 - JB150÷300
Kit Press G	2"1/2	1"1/2	0	2"	1"1/4	TP2-KD-JET150÷300
Kit Press H	2"1/2	1"1/2	0	2"	1"1/4	TP2-MKV 3 ÷ 6 ÷ 9 ÷ 12
Kit Press I	2"1/2	1"1/2	0	2"1/2	1"1/2	TP2-KC
Kit Press L	3"	2"	1"1/2F 1"1/4M	3"	1"1/2	TP2-BK400÷1003-CN 32 (max 7,5kW)
Kit Press M	3"	2"	2" F 1"1/2 F	3"	1"1/2	TP2-MVX 5
Kit Press N	DN100	2"	0	DN100	2"	TP2-MVX 9÷16
Kit Press O	DN100	2"1/2	0	3"	1"1/2	TP2-CN 40 (max 7,5kW)
Kit Press P	DN125	2"1/2	0	DN100	2"	TP2-CN 50 (max7,5kW)

DNA = Ø ASPIRAZIONE COLLETTORE / SUCTION MANIFOLD

DNM = Ø MANDATA COLLETTORE / OUTLET MANIFOLD

DNAP = Ø ASPIRAZIONE POMPA / PUMP SUCTION

DNMP = Ø MANDATA POMPA / PUMP OUTLET

ATTENZIONE Quadro elettrico e pressostati non compresi - Control panel & pressure switch not included

ACCESSORI PER ELETTROPOMPE - PUMPS ACCESSORIES
ACCESSOIRES POUR ELECTROPOMPES - ACCESORIOS PARA ELECTROBOMBAS



Vaso di espansione - *Expansion tanks* - Réservoirs d'expansion - *Tanques de expansion*

Serbatoio verticale - *Vertical tank* - Réservoirs verticale - *Tanque vertical*
 19 l. - 24 l. - 100 l. - 200 l. - 300 l. - 500 l. - 1000 l.

Serbatoio orizzontale - *Horizontal tank* - Réservoirs horizontale - *Tanque horizontal*
 20 l. - 40 l. - 60 l. - 80 l. - 100 l. - 200 l.



pressostato, manometro, raccordo 5 vie, serbatoio verticale da 24 l.

pressure switch, pressure gauge, 5 ways fitting, 24 l. vertical tanks

pressostats, manometer, raccord en laiton 5 voies, réservoirs d'expansion verticale du 24 l.
presostato, manómetro, racor 5 vías, Tanque de expansión vertical de 24 l.

pressostato, manometro, raccordo 5 vie, tubo flessibile, serbatoio orizzontale da 20 l.

pressure switch, pressure gauge, flexible hose, 5 ways fitting, 20 l. horizontal tanks

pressostats, manometer, raccord en laiton 5 voies, tube flexibles, réservoirs horizontale du 20 l.
presostato, manómetro, racor 5 vías, manguito antivibratorio, tanque horizontal de 20 l.



Membrana per usi alimentari - *Diaphragms for drinking water* -

Membrane pour l'eau potable - *Membrana de caucho natural atóxico*
 19/20/24/40 l.



Controllo elettronico per elettropompe - *Flow electronic switch* -

Regulateur de pression électronique - *Controladores electrónico de presión*



Pressostato - *Pressure switch* - Pressostats - *Presostatos*



Manometro - *Pressure gauge* - Manometer - *Manómetro*



Tubo flessibile con curva - *Flexible hose with bend* -

Tube flexibles avec courbe - *Manguito antivibratorio con curva*
 1" x 500 cm - 1" x 700 cm - 1" x 800 cm - 1" x 1000 cm



Raccordo 5 vie in ottone - *5 Ways fitting* - Raccord 5 voies - *Racor 5 vías*

Raccordo 3 vie in ottone - *3 Ways fitting* - Raccord 3 voies - *Racor 3 vías*



Valvola di fondo in ottone - *Foot valve in brass* - Clapet crépine - *Válvula de pie*
 1" - 2" - 3"



Valvola di non ritorno a palla - *Ball check valve* -

Clapets de retenue a boule - *Válvulas de retención de bola*
 2" PN 10 - DN 65 PN 10 - DN 80 PN 10



Kit per aspirazione - *Kit for suction with* - Kit d'aspiration - *Kit de succión*
 4 m - 7 m



Portagomma Ottone - *Brass hose connector* - Connexion en laiton - *Conexión en latón*
 Ø 60mm

Portagomma curvo con nipples ottone - *Brass hose connector with curve & nipples* -

Raccordo curvè et filetés en laiton - *Ajuste curvado con niples en latón*
 Ø 1" 1/4 - Ø 1" 1/2



Pistola per travaso gasolio - *Diesel pistol* -
 Pistolet pour le transfert du gasoil - *Pistola para trasvase de diesel*
 1) Plastica - *Plastic* - Technopolymère - *Plástico*
 2) Alluminio - *Aluminium* - Aluminium - *Alumino*
 3) Automatica - *Automatic* - Automatique - *Automática*



Contaltri per gasolio - *Meter for diesel oil* - Compteur pour le gasoil - *Contadores para diesel*



Galleggiante con contrappeso - *Float switch with counter weight* -
 Flotteurs avec contre-poids - *Flotador con contapeso*
 3X1 x 3 m - 3X1 x 5 m - 3X1 x 10m

Galleggiante per acque cariche - *Heavy duty Float switch with* -
 Flotteurs pour liquides charges - *Flotador para aguas sucias*
 3X1 x 10 mt

Contrappeso in plastica - *Plastic counter weight* -
 Contre-poids en technopolymère - *Contapeso de plástico*



Connessione cavo sommerso - *Submersible cable connection* -
 Jonction en resine pour le cable submersibles - *Conexión para cable sumergibles*



Tubo in plastica raccordato per gasolio - *Fitted plastic hose for diesel* -
 Tuyau avec raccords en plastic pour gasoil - *Tubo de plástico conectado para diesel*
 2 m - 4 m



Tubo in gomma raccordato per gasolio - *Fitted rubber hose for diesel* -
 Tuyau avec raccords en caoutchouc pour gasoil - *Tubo de caucho conectado para diesel*
 2 m - 4 m



Condensatori
Capacitors
 Condensateurs
Condensatores

μF 6.3 450 V 50÷60 Hz
 μF 08 450 V 50÷60 Hz
 μF 10 450 V 50÷60 Hz
 μF 12,5 450 V 50÷60 Hz
 μF 14 450 V 50÷60 Hz
 μF 16 450 V 50÷60 Hz
 μF 20 450 V 50÷60 Hz
 μF 25 450 V 50÷60 Hz
 μF 30 450 V 50÷60 Hz
 μF 31.5 450 V 50÷60 Hz
 μF 36 450 V 50÷60 Hz
 μF 40 450 V 50÷60 Hz
 μF 45 450 V 50÷60 Hz
 μF 50 450 V 50÷60 Hz
 μF 55 450 V 50÷60 Hz
 μF 60 450 V 50÷60 Hz

TABELLA DELLE PERDITE DI CARICO per tubazioni nuove e zincate
TABLE OF THE HEAD LOSSES trough new galvanized pipe lines

PORTATA m/h ³	CAPACITY l/min	DIAMETRO NOMINALE (mm _{inc}) - NOMINAL DIAMETER (mm _{inc})													
		15,75 1 1/2"	21,25 3/4"	27 1"	35,75 1 1/4"	41,25 1 1/2"	52,5 2"	68 2 1/2"	80,25 3"	92,5 3 1/2"	105 4"	130 5"	155 6"	206 8"	
0,6	10	0,856 9,01	0,47 2,09	0,291 0,65											
1,2	20	1,712 32,47	0,94 7,55	0,582 2,35	0,332 0,6										
1,8	30	2,568 68,74	1,411 15,98	0,874 4,98	0,498 1,27	0,37 0,63									
2,4	40		1,881 27,22	1,165 8,48	0,664 2,16	0,5 1,08	0,31 0,33								
3	50		2,351 41,13	1,456 12,81	0,831 2,45	0,62 1,63	0,39 0,5								
3,6	60		2,821 57,63	1,747 17,95	0,997 4,58	0,75 2,28	0,46 0,7	0,28 0,2							
4,2	70		3,291 76,64	2,039 23,88	1,163 6,08	0,87 3,03	0,54 0,94	0,32 0,27							
4,8	80			1,881 30,57	1,329 7,79	1 3,88	0,62 1,2	0,37 0,34	0,26 0,15						
5,4	90			2,621 38,01	1,495 9,69	1,12 4,83	0,69 1,49	0,41 0,42	0,3 0,19						
6	100			2,912 46,19	1,661 11,77	1,25 5,86	0,77 1,81	0,46 0,51	0,33 0,23						
7,5	125			3,641 69,79	2,077 17,79	1,56 8,86	0,96 2,74	0,57 0,78	0,41 0,35	0,31 0,17					
9	150				2,492 12,41	1,87 3,84	1,16 1,09	0,69 0,49	0,49 0,24	0,29 0,13					
10,5	175				2,907 33,15	2,18 16,51	1,35 5,1	0,8 1,45	0,58 0,65	0,43 0,32	0,34 0,17				
12	200				3,322 42,43	2,5 21,14	1,54 6,53	0,92 1,85	0,66 0,83	0,5 0,41	0,39 0,22				
15	250				4,153 64,12	3,12 31,94	1,93 9,87	1,15 2,8	0,82 1,25	0,62 0,63	0,48 0,34	0,31 0,12			
18	300					3,74 44,75	2,31 13,83	1,38 3,92	0,99 1,75	0,74 0,88	0,58 0,47	0,38 0,17			
24	400					4,99 76,2	3,08 23,55	1,84 6,68	1,32 2,98	0,99 1,49	0,77 0,81	0,5 0,28	0,35 0,12		
30	500						3,85 35,58	2,3 10,09	1,65 4,51	1,24 2,26	0,96 1,22	0,63 0,43	0,44 0,18		
36	600						4,62 49,85	2,75 14,14	1,98 6,31	1,49 3,16	1,16 1,7	0,75 0,6	0,53 0,26		
42	700							3,21 18,81	2,31 8,4	1,74 4,2	1,35 2,27	0,88 0,8	0,62 0,34	0,35 0,09	
48	800							3,67 24,08	2,64 10,75	1,99 5,38	1,54 2,9	1,01 1,03	0,71 0,44	0,4 0,11	
54	900							4,13 29,94	2,97 13,37	2,23 6,69	1,73 3,61	1,13 1,28	0,8 0,54	0,45 0,14	
60	1000							4,59 36,39	3,3 16,24	2,48 8,13	1,93 4,39	1,26 1,55	0,88 0,66	0,5 0,16	
75	1250							4,12 24,54	3,1 12,29	2,41 6,63	1,57 2,34	1,1 0,99	0,63 0,25	0,25	
90	1500							4,95 34,39	3,72 17,22	2,89 9,29	1,88 3,28	1,33 1,39	0,75 0,35	0,35	
105	1750								4,34 22,9	3,37 12,35	2,2 4,37	1,55 1,85	0,88 0,46		
120	2000								4,96 29,31	3,85 15,81	2,51 5,59	1,77 2,37	1 0,59		
150	2500									4,81 23,89	3,14 8,44	2,21 3,59	1,25 0,9		
180	3000										3,77 11,83	2,65 5,02	1,5 1,26		
240	4000										5,03 20,15	3,53 8,55	2 2,14		
300	5000											4,42 12,93	2,5 3,23		

n° Velocità acqua [m/s] - Water speed [m/s]
 N° Perdite di carico in metri per 100m di tubazione
 Total head loss in meters every 100m of pipes

TABELLA DELLE PERDITE DI CARICO VALVOLAME E RACCORDERIA
TABLE OF HEAD LOSSES VALVES AND FITTINGS

TIPO TYPE	DIAMETRO NOMINALE (mm _{inc}) - NOMINAL DIAMETER (mm _{inc})											
	25	32	40	50	65	80	100	125	150	200	250	300
	LUNGHEZZA DI TUBAZIONE TALE DA PRODURRE LA MEDESIMA PERDITA DI CARICO (m) LENGHT OF PIPE LINES TO PRODUCE THE SAME HEAD LOSS (m)											
Saracinesca Gate			0,3	0,3	0,3	0,6	0,6	0,9	1,2	1,5	1,8	
Valvola di non ritorno Check valve	1,5	2,1	2,7	3,3	4,2	4,8	6,6	8,3	10,4	13,5	16,5	19,5
Raccordo: T o Croce Fitting: T or Cross	1,5	1,8	2,4	3	3,6	4,5	6	7,5	9	10,5	15	18
Curva: Curve:												
45°	0,3	0,3	0,6	0,6	0,9	0,9	1,2	1,5	2,1	2,7	3,3	3,9
90° (gomito)	0,6	0,9	1,2	1,5	1,8	2,1	3	3,6	4,2	5,4	6,6	8,1
90° (ampia - spacious)	0,6	0,6	0,6	0,9	1,2	1,5	1,8	2,4	2,7	3,9	4,8	5,4

Per calcolare perdite di carico differenti dell'acciaio zincato moltiplicare per:
 To calculate the head losses different from galvanized multiple for:

1,3 Tubo in FIBRA CEMENTO e GHISA - Pipe in concrete and cast iron

0,8 Tubo in ACCIAIO LAMINATO e INOX - Pipe in laminated steel and stainless steel

0,7 Tubo in ALLUMINIO - Pipe in aluminium

0,6 Tubo in PVC - Pipe in PVC

CONVERSIONE UNITÀ DI MISURA CONVERSION UNITS OF MEASURE

Grandezza Size	Valore da convertire Value to convert	CONVERSIONI - CONVERSIONS							
pressione pressure		kg/cm²	Pa	kPa	bar	mm H₂O	atm	mm Hg	psi
	1 kg/cm ²	1	98066,5	98,066	0,9806	10000	0,96784	735,561	14,223
	1 Pa (N/m ²)	1,0197 10 ⁻⁵	1	0,001	10 ⁻⁵	0,101972	9,86923 10 ⁻⁶	7,50064 10 ⁻³	1,45038 10 ⁻⁴
	1 kPa	1,0197 10 ⁻²	1000	1	10 ⁻²	101,972	9,86923 10 ⁻³	7,50064	1,45038 10 ⁻¹
	1 bar	1,01972	10 ⁵	100	1	10197,2	9,86923 10 ⁻¹	750,064	14,5038
	1 kgf/m ² (mm H ₂ O)	10 ⁻⁴	9,80665	9,80665 10 ⁻³	9,80665 10 ⁻³	1	9,67841 10 ⁻⁵	7,35561 10 ⁻²	1,42233 10 ⁻³
	1 atm	1,03323	101325	101,325	1,01325	10332,3	1	760	14,6959
1 torr (mm Hg)	1,35951 10 ⁻³	133,322	0,13332	1,3332 10 ⁻³	13,5951	1,31579 10 ⁻³	1	1,93367 10 ⁻²	
1 lbf/in ² (psi)	7,0307 10 ⁻²	6894,76	6,89476	6,89476 10 ⁻²	703,07	6,8046 10 ⁻²	51,7151	1	
lunghezza length		m	dm	cm	mm	in	ft	yd	
	1 m	1	10	100	1000	39,36	3,28	1,0936	
	1 dm	0,1	1	10	100	3,936	0,328	0,1094	
	1 cm	0,01	0,1	1	10	0,394	0,033	0,0109	
	1 mm	0,001	0,01	0,1	1	0,039	0,003	0,0011	
	1" (inch o in o pollice)	0,0254	0,254	2,54	25,4	1	0,0833	0,0278	
	1' (foot o ft o piede)	0,3048	3,048	30,48	304,8	12	1	0,3333	
1 yd (yard)	0,9144	9,144	91,44	914,4	36	3	1		
portata capacity		l/min	l/s	m³/h	m³/s	Imp.g.p.m.	US.g.p.m.		
	1 l/min	1	0,0166	0,06	1,67 10 ⁻⁵	0,21997	0,2642		
	1 l/s	60	1	3,6	0,001	13,252	15,916		
	1 m ³ /h	16,667	0,2778	1	2,77 10 ⁻⁴	3,6662	4,4053		
	1 m ³ /s	60000	1000	3600	1	13175,2	15822,8		
	1 Imp.g.p.m.	4,546	0,07546	0,27276	7,59 10 ⁻⁵	1	1,201		
1 US.g.p.m.	3,785	0,06283	0,227	6,32 10 ⁻⁵	0,8326	1			
potenza power		W	kW	CV	HP	lbf ft/s			
	1 W	1	0,001	1,35962 10 ⁻³	1,34102 10 ⁻³	7,37561 10 ⁻¹			
	1 kW	1000	1	1,35962	1,34102	737,561			
	1 CV	735,499	7,35499 10 ⁻¹	1	9,8632 10 ⁻¹	542,475			
	1 HP	745,7	0,7457	1,01387	1	550			
1 lbf ft/s	1,35582	1,35582 10 ⁻³	1,8434 10 ⁻³	1,81818 10 ⁻³	1				
peso e forza weight and force		kg	N	lb					
	1 kg	1	9,81	2,203					
	1 N	0,102	1	0,2246					
1 lb	0,454	4,452	1						
temperatura temperature	°C	=K-273	=5/9(°F-32)						
	K	=°C+273	=5/9(°F-32)+273						
	°F	=9/5°C+32							



A series of horizontal dashed lines spanning the width of the page, providing a template for writing or drawing.

Blank page with horizontal dashed lines for writing.

Printed in Italy 5/2013
Arti Grafiche Meroni - Lissone

La Sea-Land S.r.l., al fine di migliorare i propri prodotti
si riserva di apportare modifiche in ogni momento
e senza preavviso alcuno.

*With a policy of continuous product development Sea-Land S.r.l.
reserves the right to modify product design and specification
without due notice.*