

Makita®



2020/21 ACCESSORY CATALOGUE

Safety



Wear Eye Protection



Wear Ear Protection



Wear A Mask



Wear Protective Gloves



Read The Instruction Manuals



Wear Protective Shoes



Remove Plug From Socket

Materials

Stone



Reinforced Concrete



Red Brick



Brick



Porous Concrete

Wood



Wood



Wood With Nails



Laminate



Laminate



Sandwich Panel



Plywood



Veneered Wood



Sandwich Material



Chipboard

Metal



Metal



Metal Plates



Aluminum



Sheet Metal



Non-ferrous Metals



Metal & Stainless



Stainless Steel



Cast Iron

Other Materials



Glass Fibre Reinforced Plastic, Epoxy



Glass



Wood And Plastic Combined



Ceramic Tiles



Plastic



Fiber Cement Board



Perspex



Aerated Concrete Block



Wood And Metal



Plaster Board

Drilling (Wood/Metal) 20



Drilling (Masonry) 35



Fastening 51



Drill and Screw Bit Sets 59



Cutting 61



Jigsaw / Reciprosawing 71



Brushing 82



Bonded Abrasive 84



Coated Abrasive 96



Multi Tool 106



Diamond 115



Planing / Routing 129



OPE 135



Cleaning / Vacuum System 148



Miscellaneous 167



Blue Collection 205



System Charts

Drilling / Fastening



Fastening P.51



Drilling (Wood/Metal) P.20



Coated Abrasive P.96



Brushing P.82

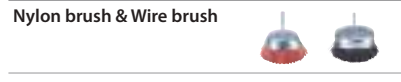

Drilling (Masonry) P.35

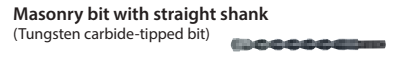

Diamond P.115



Fastening P.51



Drilling (Wood/Metal) P.20



Drilling (Masonry) P.35

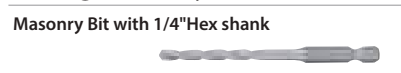

Fastening P.51

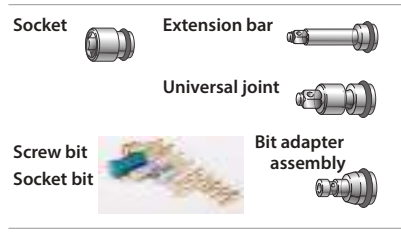

Fastening P.51



Miscellaneous P.167

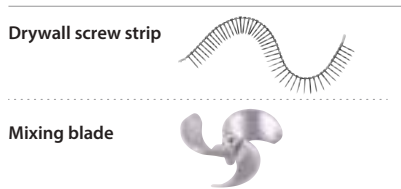

Impact Drilling Demolition



Drilling (Wood/Metal) P.20



Diamond P.115



Drilling (Masonry) P.35

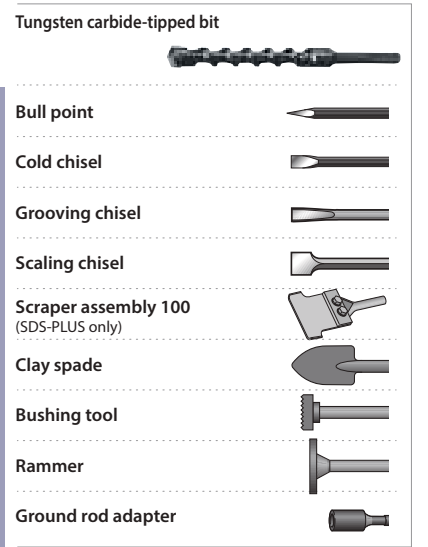

Cutting (New Material, Masonry, Metal)



Diamond P.115



Bonded Abrasive P.84



Cutting P.61

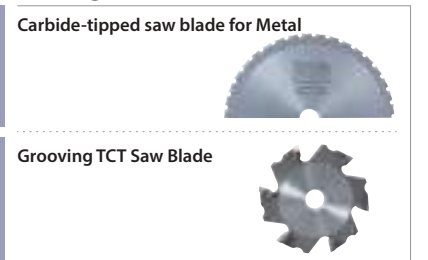







Jigsaw / Reciprosawing P.71









System Charts



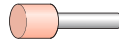





Grinding Sanding

	Bonded Abrasive P.84 Depressed center wheel  Flexible grinding wheel  Cut-off wheel  Thin Cut-off wheel 
Angle Grinder 	Coated Abrasive P.96 Flap Disc  Multi-disc  Fiber sanding disc 
	Brushing P.82 Wire brush  
Concrete Planer 	Diamond P.115 Diamond wheels  Offset diamond wheel 
Disc Sander 	Coated Abrasive P.96 Fiber sanding disc 
Polisher 	Wool bonnet  Wool pad  Sponge pad 
Stone Polisher 	100mm Diamond polishing pad (Hook & loop type) 
Belt Sander 	Abrasive belt 
Finishing Sander 	Abrasive paper 
Random Orbit Sander 	Abrasive disc 
Wheel Sander 	Brushing P.82 Wheel 





Grinding Sanding

Die Grinder 	Coated Abrasive P.96 Flap wheel 
Bench Grinder Straight Grinder 	Bonded Abrasive P.84 Wheel point  Tungsten carbide burrs  Grinding wheel 
Multi Tool 	Multi Tool P.106 Multi Tool Accessories 

Sawing

Slide Compound Miter Saw Circular Saw Table Saw 	Cutting P.61 Saw blade 
Jig saw 	Jigsaw / Reciprosawing P.71 Jig saw blade 
Reciprosaw 	Reciprosaw blade 
Band saw 	Band saw blade 

Planing / Routing

Planer 	Planing / Routing P.129 Planer blade  Mini planer blade 
Router 	Router bit 

Pneumatic Tools

	Miscellaneous P.167 Nails  Staple 
--	--

Outdoor Power Equipment

	P.135 Brushcutter blades  Chain blade  Shear blade  Nozzle  Nylon cutting head 
--	--

Ideal for Cordless Tool Accessories

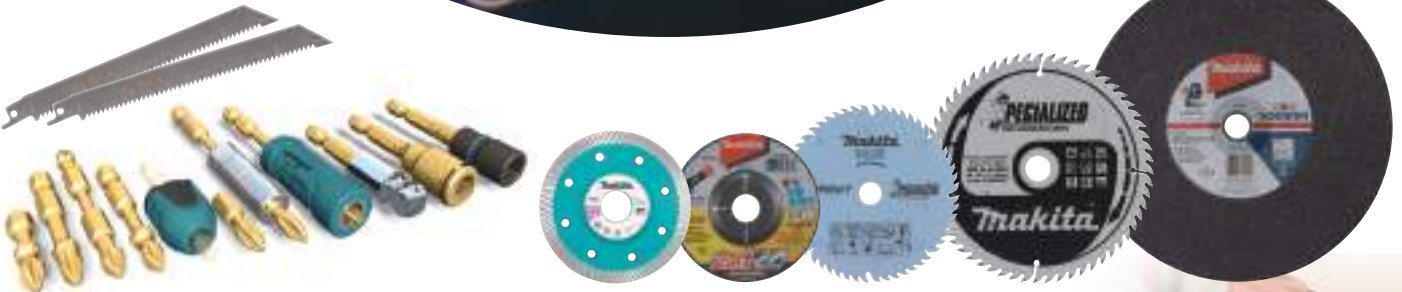
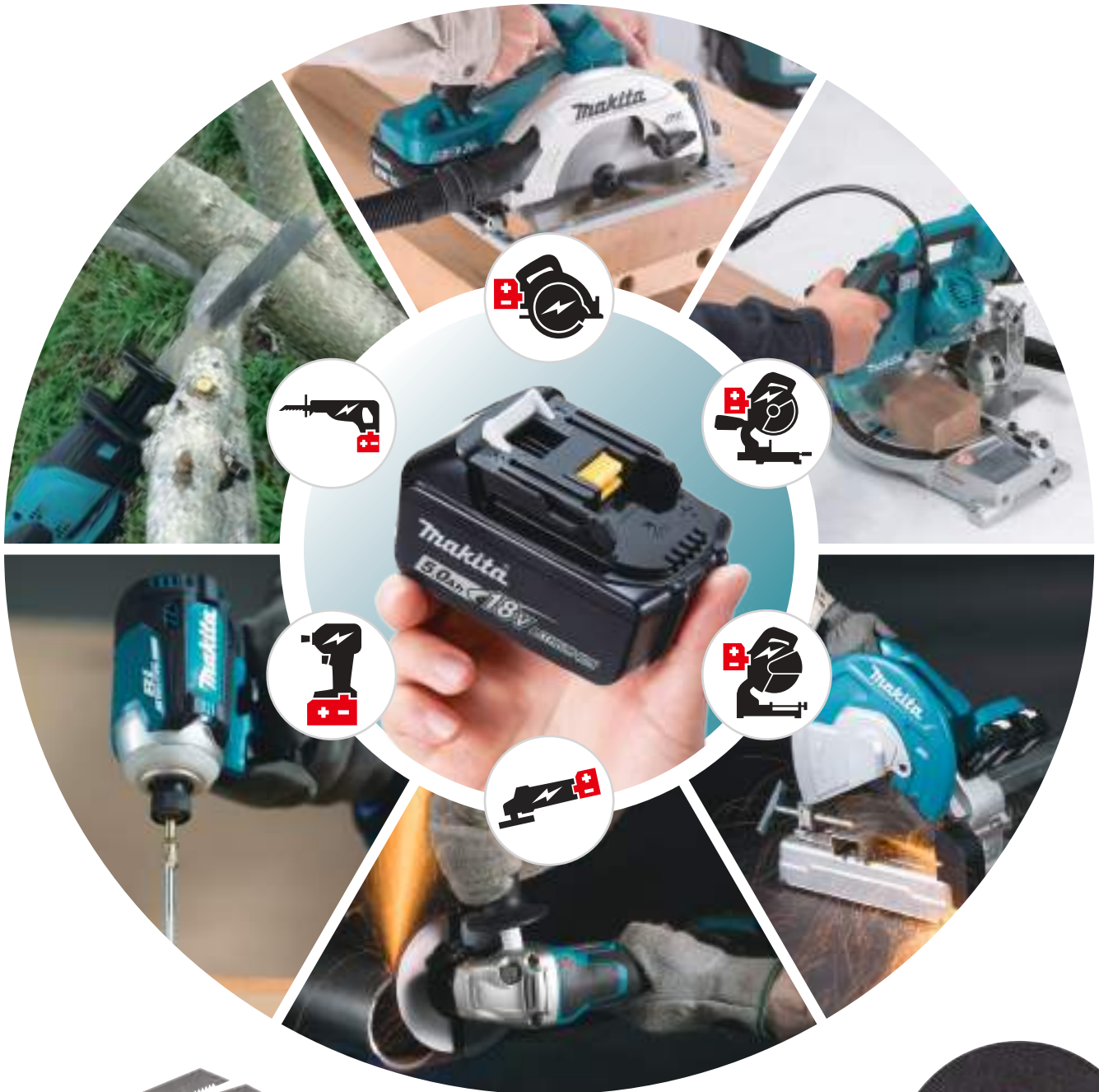

What is Ideal for DC tool Accessories ?

Provides the greatest performance on DC tools!

Higher speed, more work amount on a single full battery charge and a nice sense of use.* Here are the parties which give you the greatest performance on your MAKITA DC tools. You can find recommended accessories for DC tools with DC tool icons with an emphasized battery symbol. Try and see MAKITA's leading-edge technology.

*Features may vary by item.





This movie was filmed in Japan. Models and specs may vary by country.

EFFICUT



Efficient Sharp Tip's Top Angle



Efficient Curved Tip's Body



Efficient Slimmed Tip's Bottom



**Ideal For
Cordless**

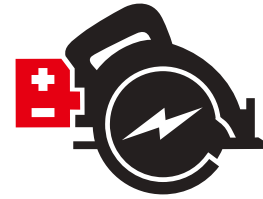

The amount of cutting per 1 charge

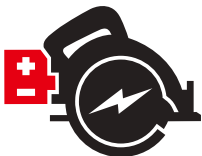
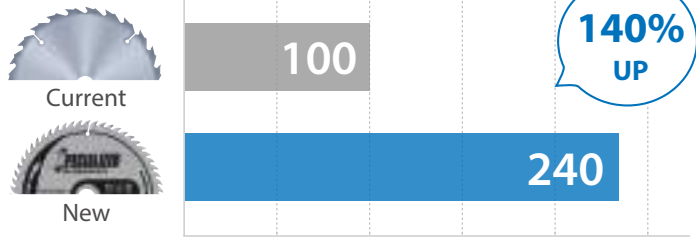

Double cut

Reduce the area contacting the work

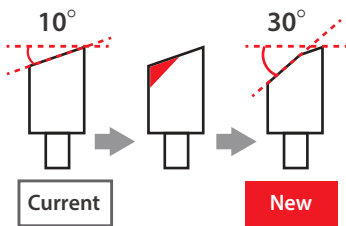

Double cut shape

Make the teeth top angle as 10 degrees, cut the side to make bevel tops as 30 degrees and that reduces cutting resistance. With these teeth shape, it can cut fast and lightly.

The amount of cutting per 1 charge

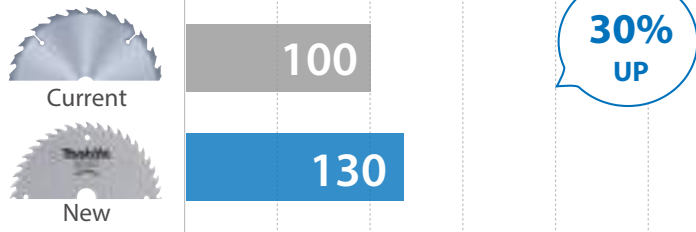

Extra sharp

Make tip bevel angle sharp

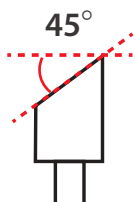

Extra sharp edge 45 degrees

Making teeth top angle as 45 degrees, the cutting resistance is reduced. It enables you to cut fast and lightly.

The amount of cutting per 1 charge

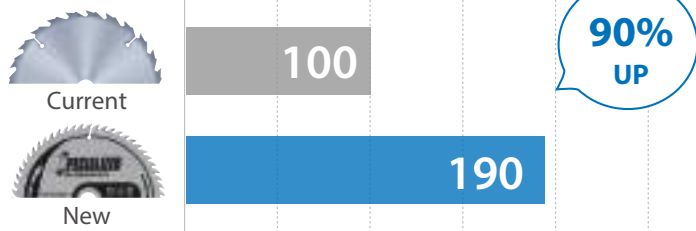

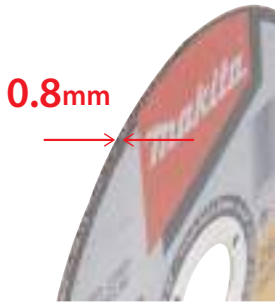
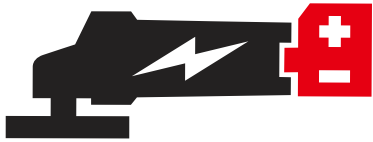

Thin cutting wheel

0.8mm thickness for fast cutting

Thinner thickness

0.8mm thinner thickness brings ... fast cutting / reduction of cutting resistance / less burr of materials / less dust of materials

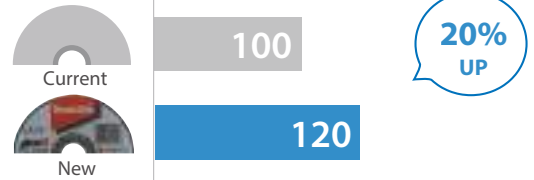

The amount of cutting per 1 charge



2in1 grinding wheel

Cutting and deburring are possible in one disc

Specialized cutting work

Thanks to "SA" grid and 2.2mm thinner thickness, it enables you to cut fast and deburring safety.

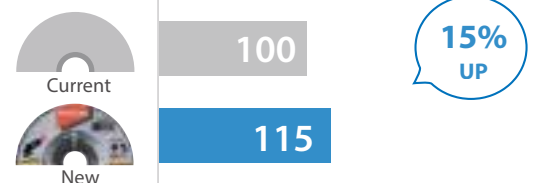

The amount of cutting per 1 charge



Flexible grinding wheel

Low vibration and no need back-up pad

Shock absorbed structure

Added shock absorbing material. You can feel overwhelmingly low vibration. Grinding speed is also faster because of its flexibility. It can touch materials more efficiency.

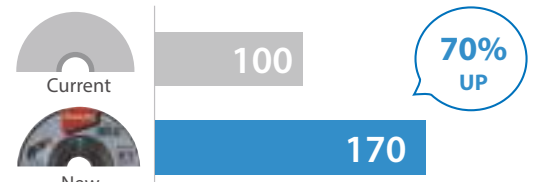

The amount of grinding per 1 charge

Thin diamond wheel

Smooth & light cutting

for Tile

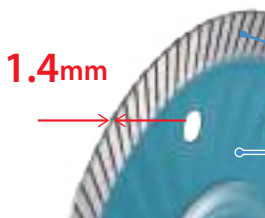

Thinner thickness & enough strength

1.4mm thickness able to get smooth and light cutting.

Corrugated Rim increases wheel tension and reduces vibration during the cut.

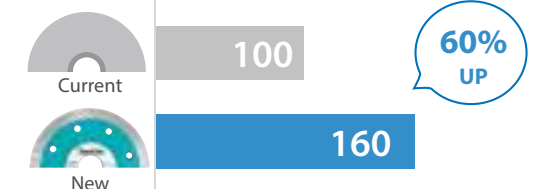

The amount of cutting per 1 charge

for Concrete/ Stone

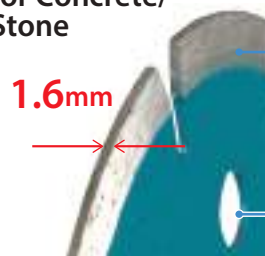

Specialized cutting work

This blade is designed as 1.6mm. So smooth and light cutting is available.

It was lightened by punching the body. It is also reduce the load on the battery and increased the cutting distance per 1 battery charge.

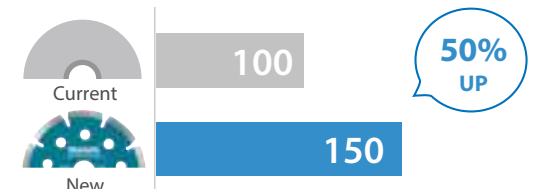

The amount of cutting per 1 charge



Abrasive Cut-off wheel Specialized for Metal stud



2.5mm



Thinner blade & the optimum bonding

2.5mm thickness blade for smooth and fast cutting.
The optimum bonding for fast cutting and longer life.

The amount of cutting per 1 charge



Current

100



New

130

30%
UP



Impact GOLD Extreme Torsion Technology

Extreme torsion technology



Torsion section flexes under load and takes pressure off bit tip



Longer life time

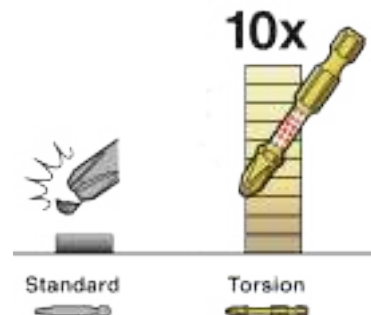

Standard

10x

Torsion

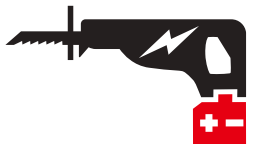

Japanese teeth Reciprosaw Blade

0.6mm thickness Japanese teeth
for fine cutting surface



Japanese teeth

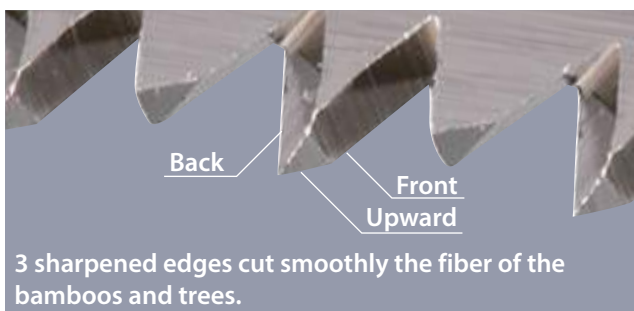

For model: DR185, DJR183, DJR145, JR100D, JR103D, JR105D

Purpose-built brushless motors

Makita-built Brushless Motor eliminates carbon brushes, enabling the motor to run cooler and more efficiently for longer life. The electronically controlled Brushless Motor efficiently uses energy to match torque and RPM to the changing demands of the application.

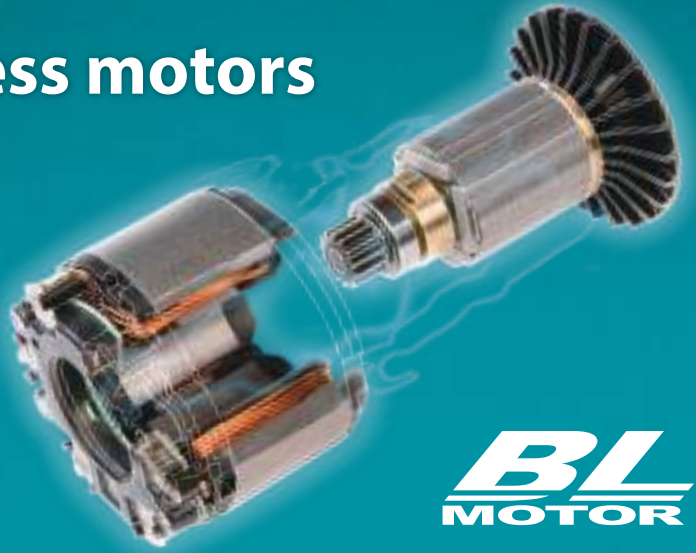



















BL
MOTOR

XGT 40V L-ION max

<p>Driver Drill DF001G</p> 	<p>Hammer Driver Drill HP001G</p> 	<p>Impact Driver TD001G</p> 	<p>Impact Wrench TW001G</p> 	<p>Combination Hammer HR001G / HR002G / HR003G / HR004G</p> 
<p>Recipro Saw JR001G</p> 	<p>Angle Grinder GA003G / GA004G / GA005G / GA011G</p> 	<p>Circular Saw HS003G / HS004G</p> 		

18V + 18V → 36V

<p>Combination Hammer DHR280 / DHR281 / DHR282 / DHR283</p> 	<p>Rotary Hammer DHR400N</p> 	<p>Recipro Saw DJR360</p> 	<p>Angle Grinder DGA700 / DGA900 / DGA701 / DGA901</p> 	<p>Angle Drill DDA460</p> 
<p>Shear Wrench DWT310</p> 	<p>Portable Cut-off DLW140</p> 	<p>Slide Compound Miter Saw DLS714 / DLS211</p> 	<p>Circular Saw DHS782 / DHS783 / DHS900</p> 	<p>Plunge Cut Saw DSP600 / DSP601</p> 
<p>Backpack Vacuum Cleaner DVC261 / DVC265 / DVC660 / DVC665</p> 	<p>Chain Saw DUC353 / DUC355 / DUC306</p> 	<p>Multi Function Power Head DUX60</p> 	<p>Grass Trimmer DUR364L / DUR365U / DUR366L / DUR368L / DUR369L</p> 	<p>Lawn Mower DLM460 / DLM530 / DLM532</p> 
<p>Blower DUB362 / DUB363</p> 	<p>Power Cutter DCE090</p> 	<p>Grass Trimmer UR202C</p> 		



Driver Drill

DDF083 / DDF481 / DDF482 / DDF483 / DDF484



Hammer Driver Drill

DHP481 / DHP483 / DHP484 / DHP485



Impact Driver

DTD153 / DTD154 / DTD155 / DTD171



Impact Wrench

DTW180 / DTW181 / DTW285 / DTW800 / DTW1001 / DTW1002



Screwdriver

DFS250 / DFS251



Power Scraper

DHK180



Combination Hammer

DHR242 / DHR243



Rotary Hammer

DHR171 / DHR182



Random Orbit Polisher

DPO500 / DPO600



Angle Grinder

DGA406 / DGA408 / DGA413 / DGA417 / DGA454 / DGA455 / DGA506 / DGA508 / DGA513 / DGA514 / DGA517 / DGA518 / DGA419 / DGA469 / DGA519



Drywall Sander

DSL800



Steel Rod Cutter

DSC121 / DSC163 / DSC251



Threaded Rod Cutter

DSC102



Rebar Tying Tool

DTR180



Compound Miter Saw

DLS600



Metal Cutter

DCS551 / DCS553



Circular Saw

DHS660 / DHS661



Recipro Saw

DJR187 / DJR188



Jig Saw

DJV181 / DJV182



Planer

DKP181



Trimmer

DRT50



Robotic Cleaner

DRC200



Cyclone Cleaner

DCL501



Portable Vacuum Cleaner

DVC750L



Cleaner

DCL280F / DCL281F / DCL282F



Wheelbarrow

DCU180



Grass Trimmer

DUR189



Chain Saw

DUC254



Hedge Trimmer

DUN500W / DUN600L



Hedge Trimmer

DUH601 / DUH751 / DUH502 / DUH604S / DUH754S



Blower

DUB184



Fan Jacket

DFJ210 / DFJ211 / DFJ310 / DFJ311 / DFJ410 / DFJ411 / DFJ212 / DFJ213 / DFJ214

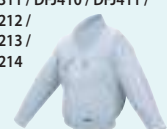

Fan Vest

DFV210



Mixer

DUT130



Driver Drill

DF332D / DF032D

Hammer Driver Drill

HP332D



Impact Driver

TD111D

Impact Wrench

TW160D / TW161D



Rotary Hammer

HR166D



Jig Saw

JV102D / JV103D



Threaded Rod Cutter

SC103D



Tool ↔ Battery ↔ Battery Charger
Digital communication

XGT is a new system with its own tools, batteries, and chargers. A combination of innovative tool design and higher output batteries provide a genuine solution for high demand industrial users.

Optimum power supply system and Optimum charging system

The XGT range of tools and batteries come with a built-in program, providing digital communication between the battery and tool. Allowing not only for the battery to talk with tool but also the tool to talk to the battery. Battery technology and motor engineering that work together for optimum performance.

Optimum charging system

Auto maintenance system with two cooling fans for providing more optimum fast charging



Built Tough

High durability specifications specially designed for 40Vmax Li-Ion batteries

4-LED fuel gauge indicator



Terminal short-circuit prevention structure
The protection wall is provided between terminals against water and dust.

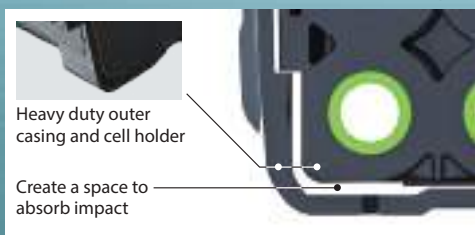

Heavy duty outer casing and cell holder
Create a space to absorb impact

Shock absorption structure

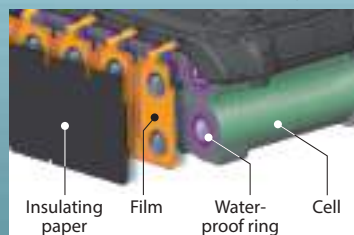

Insulating paper Film Water-proof ring Cell
Waterproof Triple-layer Structure
prevents cell failure due to water and dust.



High Rigidity Battery Rails
Durable slide in battery rail that holds the battery and the tools firmly and securely to withstand high power products

Rapid Optimum Charging System

It is necessary to cool down before start charging when the battery temperature is high. Built-in fan circulates air through the battery before start charging and during the charging process to cool the battery for faster charge time.

The Makita Rapid Optimum Charger communicates with the battery's built-in chip throughout the charging process to optimize battery life by actively controlling current, voltage and temperature.

The optimum charging system
Forced air cooling



Fast charging



General charging method
Natural heat dissipation



Waiting time for charging



The optimum charging system

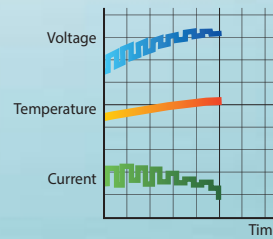

General charging method

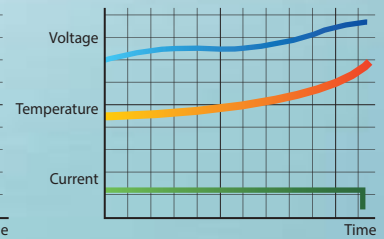

Battery Protection Function

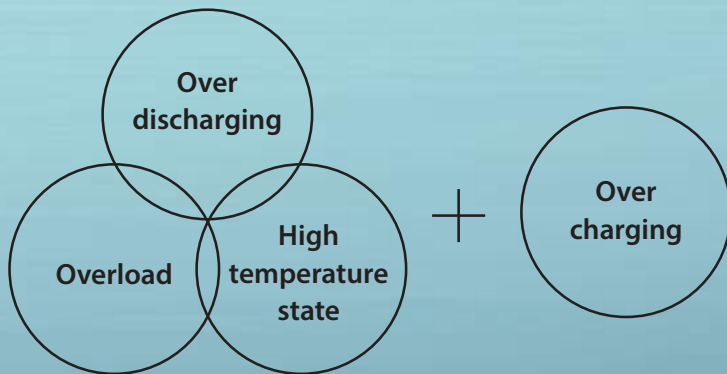

This function is communication technology that allows the tool and battery to monitor conditions and exchange data in real time to protect against Overload, Over-Discharge and Overheating.

Firm Holding

Multi-contact terminals reduce electrical resistance and increase connection stability withstanding against vibration, and ultimately ensures Stable current supply to the tool.

Anytime Charge
No Memory Effect
No discharging required



Shock Absorbing
Heavy Duty Pack

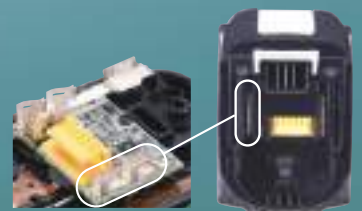

Li-ion Battery & Charger Time Reference, Compatibility Chart

DC40RA



The enlarged and raised LED light provides clearer indication of charging status.



18V
Lithium-ion

Fast Charging



DC40RA



ADP10



Compatible with
LXT Li-Ion batteries

6.0
5.0
Ah



BL1860B
(197422-4)
BL1850B
(197280-8)

40min.

4.0
Ah



BL1840B
(197265-4)

29min.

3.0
Ah



BL1830B
(197599-5)

22min.

2.0
Ah



BL1820B
(197254-9)

24min.

1.5
Ah



BL1815N
(196449-1)

15min.



40Vmax
Lithium-ion

Fast Charging



DC40RA

4.0
Ah



BL4040

45min.

2.5
Ah



BL4025

28min.



18V
Lithium-ion

Fast Charging



DC18RC
(195586-8)



DC18RD
Two Port Multi
Fast Charger (196934-4)



DC18RE
Dual Voltage (18V, 12V)
Fast Charger (198446-3)



DC18SD
(194534-4)



DC18SE
(Automotive)
(194621-9)

6.0
Ah



BL1860B
(197422-4)
with Batter
fuel gauge

55min.

130min.

5.0
Ah



BL1850B
(197280-8)
with Battery
fuel gauge

45min.

110min.

4.0
Ah



BL1840B
(197265-4)
with Battery
fuel gauge

36min.

90min.

3.0
Ah



BL1830B
(197599-5)
with Battery
fuel gauge

22min.

60min.

2.0
Ah



BL1820B
(197254-9)
with Battery
fuel gauge

24min.

45min.

1.5
Ah



BL1815N
(196449-1)

15min.

30min.



12Vmax
Lithium-ion

Fast Charging



DC105B
(197370-7)



DC18RE
Dual Voltage (18V, 12V)
Fast Charger (198446-3)



DC10WD
(197371-5)

4.0
Ah



BL1041B
(197406-2)

60min.

130min.

2.0
Ah



BL1021B
(197396-9)

30min.

70min.

1.5
Ah



BL1016
(197393-5)

22min.

50min.

7.2V
Lithium-ion

1.5
Ah



BL0715
(198000-3)

1.0
Ah

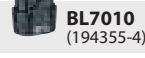

BL7010
(194355-4)

10.8V
Lithium-ion

1.3Ah



BL1013
(194550-6)

35min.

30min.

BL1013

50min.

14.4V / 18V
Lithium-ion / Lithium-ion

G-Series

1.5
Ah



BL1815G
(198186-3)



***BL1415G**
(194558-0)



DC18WA
(195424-4)

70min.

*For Model: DF347D, HP347D, JV143D, ML187, TD126D, UH420D, UH480D, UH520D, UM165D, UR140D, DMR106

Battery & Charger Time Reference Chart (in Minutes)



		24V Ni-MH	14.4V Ni-MH	12V Ni-MH	9.6V Ni-MH	DC18RC (195586-8)	DC18SD (194534-4)	DC18SE (Automotive) (194621-9)	DC24WA	DC24SC (194164-1)
3.1 Ah	BH2433 (193739-3)	BH1433 (193354-3)	BH1233C (A-37655)	-	-	9.6V,12V 14.4V,18V	9.6V,12V 14.4V,18V	9.6V,12V 14.4V,18V	9.6V,12V,14.4V 18V,24V	9.6V,12V,14.4V 18V,24V
						22	70	70	70	30 BH2433 : 60min. DC24SC-BH2433 : 50min.
1.8 Ah	BH2420 (193736-9)	-	BH1220C (193928-0)	*BH9020A (193590-1)	BH9020 (193631-3)					
						15	40	40	40	20
						BH9033/A : 30min.			BH2433 : 90min.	BH2420 : 55min. BH2420 : 30min.

() Part No. * Power Display Type

MAKPAC Power Source Kit



MKP1RF182 (197974-5)	Rapid Charger (DC18RC), 2X18V-3.0Ah Batteries (BL1830B), Makpac	
MKP1RT182 (197803-2)	Rapid Charger (DC18RC), 2X18V-5.0Ah Batteries (BL1850B), Makpac	
MKP3PT182 (198182-1)	Dual Port Rapid Charger (DC18RD), 2X18V-5.0Ah Batteries (BL1850B), Makpac	
MKP3PT184 (197627-6)	Dual Port Rapid Charger (DC18RD), 4X18V-5.0Ah Batteries (BL1850B), Makpac	
MKP1RG182 (198119-8)	Rapid Charger (DC18RC), 2X18V-6.0Ah Batteries (BL1860B), Makpac	
MKP3PG182 (198081-7)	Dual Port Rapid Charger (DC18RD), 2X18V-6.0Ah Batteries (BL1860B), Makpac	
MKP3PG184 (198095-6)	Dual Port Rapid Charger (DC18RD), 4X18V-6.0Ah Batteries (BL1860B), Makpac	
MKP4PF1841 (198786-9)	Dual Port Rapid Charger (DC18RD), 4X18V-3.0Ah Batteries (BL1830B), DGA404Z, Makpac	
MKP4PT1841 (198797-4)	Dual Port Rapid Charger (DC18RD), 4X18V-5.0Ah, Batteries (BL1850B), DGA404Z, Makpac	

MAKPAC Power Source Kit



MKP1SY122 (197654-3)	Fast Charger (DC10SB), 2X12V max -1.5Ah Batteries (BL1016B), Makpac	
MKP1SA122 (197664-0)	Fast Charger (DC10SB), 2X12V max -2.0Ah Batteries (BL1021B), Makpac	
MKP1SM122 (197640-4)	Fast Charger (DC10SB), 2X12V max -4.0Ah Batteries (BL1041B), Makpac	

Makita Cordless Part Number Breakdown

DSE	Charger (DC10WA), 2X7.2V-1.0Ah Batteries (BL7010)	
DW	Charger (DC10WA), 1X10.8V-1.3Ah Battery (BL1013)	
DWE	Charger (DC10WA), 2X10.8V-1.3Ah Batteries (BL1013)	
DWYE	Standard Charger (DC10WD), 2X12V max -1.5Ah Batteries (BL1016B)	
DSYE	Fast Charger (DC10SB), 2X12V max -1.5Ah Batteries (BL1016B)	
DSAE	Fast Charger (DC10SB), 2X12V max -2.0Ah Batteries (BL1021B)	
DSAJ	Fast Charger (DC10SB), 2X12V max -2.0Ah Batteries (BL1021B), Makpac	
DSME	Fast Charger (DC10SB), 2X12V max -4.0Ah Batteries (BL1041B)	
SYE	Standard Charger (DC18SD), 2X18V-1.5Ah Batteries (BL1815B)	
RYE	Rapid Charger (DC18RC), 2X18V-1.5Ah Batteries (BL1815B)	
SF	Standard Charger (DC18SD), 1X18V-3.0Ah Battery (BL1830B)	
RF	Rapid Charger (DC18RC), 1X18V-3.0Ah Battery (BL1830B)	
RFE/RF2	Rapid Charger (DC18RC), 2X18V-3.0Ah Batteries (BL1830B)	
RFJ	Rapid Charger (DC18RC), 2X18V-3.0Ah Batteries (BL1830B), Makpac	
RME	Rapid Charger (DC18RC), 2X18V-4.0Ah Batteries (BL1840B)	
RTE/RT2	Rapid Charger (DC18RC), 2X18V-5.0Ah Batteries (BL1850B)	
RTJ	Rapid Charger (DC18RC), 2X18V-5.0Ah Batteries (BL1850B), Makpac	
PT2	Dual Port Rapid Charger (DC18RD), 2X18V-5.0Ah Batteries (BL1850B)	
G2	2X18V-6.0Ah Batteries (BL1860B)	
PG2J	Dual Port Rapid Charger (DC18RD), 2X18V-6.0Ah Batteries (BL1860B), Makpac	

Makita Coding System - Ending Alphabet

DTD170 R T E

Charger

S - Standard Charger
R - Rapid (Fast) Charger
P - Two Port Charger

Come with Battery

H - 1.3Ah **M** - 4.0Ah
Y - 1.5Ah **T** - 5.0Ah
A - 2.0Ah **G** - 6.0Ah
F - 3.0Ah

Comes with
2 batteries

Other:
B - Double Insulation
C - Electronic Control
F - LED Light
K - Carrying Case
Z - 18V x 2 Tools

Z

Tool come with
carton box only

For more information, please contact Makita authorised distributor's technical team.

This movie was filmed in Japan.
Models and specs may vary by country.



18V X2 Lithium-ion

Powered by two 18V Li-ion
batteries in series

18V + 18V → 36V LXT

EXPAND YOUR LITHIUM-ION LINEUP



Lawn Mower
DLM460 / DLM382 / DLM432 /
DLM462 / DLM530 / DLM532 /
DLM533

Chain Saw
DUC405 / DUC400 / DUC355 /
DUC353 / DUC305 / DUC303 /
DUC302 / DUC252 / DUC252C /
DUC256 / DUC306 / DUC356 /
DUC406

Blower
DUB361 /
DUB362 /
DUB363

Hedge Trimmer
DUH551 / DUH651

Grass Trimmer
DUR364L / DUR368A /
DUR368L / DUR369A /
DUR369L / DUR369N

**Battery Powered
Pruning Shears**
DUP361 / DUP362

**Multi Function
Power Head**
DUX60

Battery Converter
BCV01

**Corded and Cordless
Vacuum Cleaner**
DVC860L / DVC861L /
DVC150L / DVC151L

**Backpack
Vacuum Cleaner**
DVC261 / DVC265 /
DVC660 / DVC665

Vacuum Cleaner
DVC865L / DVC866L / DVC867L /
DVC155L / DVC156L / DVC157L

Battery Converter
BCV03

Combination Hammer
DHR263 / DHR264 /
DHR280, DHR282+DX08 /
DHR281, DHR283+DX09

Rotary Hammer
DHR400N

Angle Grinder
DGA701 / DGA901 /
DGA700 / DGA900

Recipro Saw
DJR360

**Portable
Cut-off**
DLW140

Slide Compound Miter Saw
DLS714 / DLS110 / DLS111 /
DLS112 / DLS211 / DLS212

Circular Saw
DHS710 / DHS711 / DHS781 /
DHS780 / DHS782 / DHS783 /
DHS900 / DHS901

Power Cutter
DCE090

Shear Wrench
DWT310

Rear Handle Saw
DRS780

Plunge Cut Saw
DSP600 / DSP601

Angle Drill
DDA460

Battery Adapter
BAP182

18V LITHIUM-ION



Recipro Saw
Rear Handle Saw

Rotary Hammer

Stapler

Slide Compound Miter Saw

Combination Hammer

Portable Cut-off

Concrete Vibrator

Pin Nailer

Finish Nailer

Shear Wrench

Angle Drill

Wheelbarrow

Rebar Tying Tool

Caulking Gun

Vacuum Pump

Rivet Gun

Grease Gun

Hole Puncher

Inflator

Rechargeable Flashlight

Flashlight

LED Flashlight

LED Worklight

Fan

Flashlight Radio

Area Worklight

Fan Jacket

Heated Blanket

Fan Vest

Heated Jacket

Heated Vest

Coffee Maker

Job Site Radio

Job Site Speaker



18V Lithium-ion

Blower

Chain Saw

Hedge Trimmer

Robotic Cleaner

Trimmer

Recipro Saw

Grass Shear

Vacuum Cleaner

Planer

Drywall Saw

Grass Trimmer

Cleaner

Portable Vacuum Cleaner

Cut-Out Tool

String Trimmer

Cyclone Cleaner

Cut-Out Tool

Jig Saw

Plate Joiner





Chain Saw

Angle Grinder

Grass Trimmer

Pruning Shears

Circular Saw

Blower

Portable Power Pack

Lawn Mower

Plunge Cut Saw

Hedge Trimmer

Impact Wrench

Vacuum Cleaner

Multi Function Power Head

Screwdriver

Power Cutter

Backpack Vacuum Cleaner

Mixer

4 Mode Impact Driver

18V x2

Auto Feed Screwdriver

Angle Drill

Mixer

4 Mode Impact Driver

320+ TOOLS

6.0Ah 5.0Ah 4.0Ah 3.0Ah 2.0Ah 1.5Ah

Angle Impact Wrench

Driver Drill

Impact Driver

Angle Impact Driver

Oil-Pulse Driver

Hammer Driver Drill

Rotary Hammer

Multi Tool

Metal Shear

Combination Hammer

Steel Rod Cutter

Power Scraper

Circular Saw

Nibbler

Metal Cutter

Die Grinder

Threaded Rod Cutter

Portable Band Saw

Random Orbit Polisher

Drywall Sander

Random Orbit Sander

Angle Grinder

Slide Compound Miter Saw

Compound Miter Saw

Expand Your Lithium Line Up

ACCESSORIES

Drilling (Wood/Metal)



118° chisel edge



135° split point



HSS-R



HSS-G



HSS-Co 5%



M-force



HSS-TiN



For SDS-PLUS Hammers



HM/CT Tungsten carbide tipped



Use coolant.



Do not drill with impact

Drilling (Wood / Metal)

HSS metal drill bit series

Range

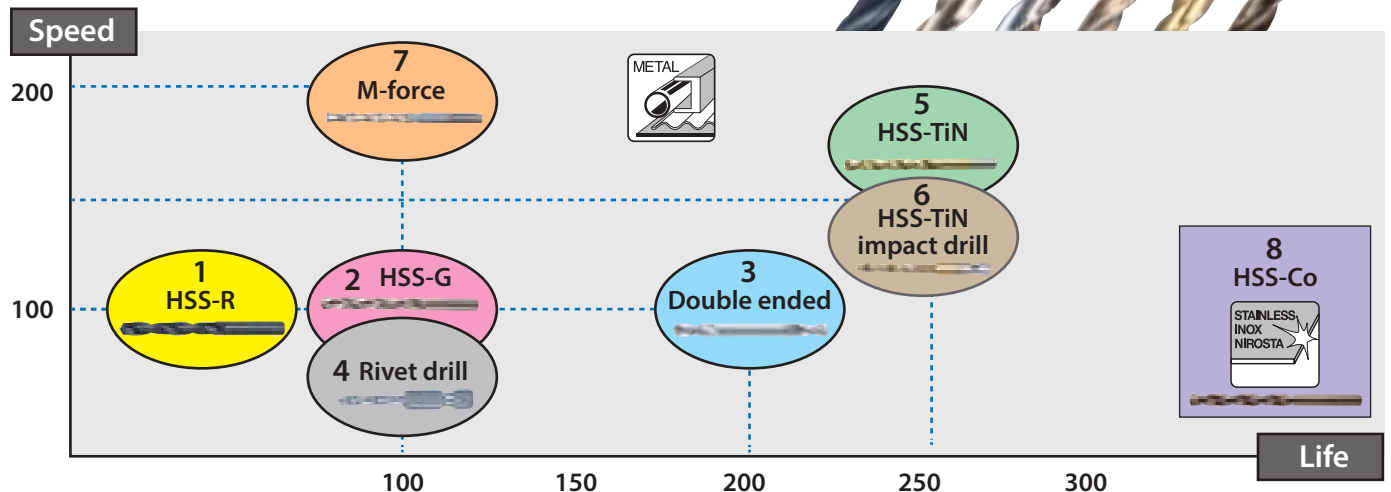

Description	1	2	3	4	5	6	7	8
Range	★★	★★★	★★★★	★★★★	★★★★★	★★★★★	★★★★★	Specialized
Description	HSS-R 	HSS-G 	Double ended 	Rivet drill 	HSS-TiN 	HSS-TiN impact drill 	M-force 	HSS-Co5%
Made of				HSS 				HSS-Co 5%
* Process of manufacturing	Roll forged 			Ground 				
** Tip geometry	Chisel edge 118° 		Split point 135° 				M-shape 	Split point 135°
Surface	Black oxide finish Rust resistant	Bright finish 			TiN coating Long life		Amber finish Rust resistant	
Shank	Straight (Cylindrical) 			Straight or 1/4"Hex 	Straight (Cylindrical) Straight or 1/4"Hex 	Straight or 1/4"Hex 	Straight (Three flat) Better grip than Cylindrical shank	Straight (Cylindrical)

AA : Recommended A : Acceptable

Material chart	1	2	3	4	5	6	7	8
Material	Wood	A	A	A	A	A	A	
	Plastic	AA	AA	AA	AA	AA	AA	
	Non-ferrous metal***		AA	AA	AA	AA	AA	A
	Sheet steel	A	AA	AA	AA	AA	AA	A
	Cast iron	AA	AA			AA	AA	AA
	Alloy steel		AA			AA	AA	AA
	Stainless steel		A			A	A	A

* Roll forged: Made by die-casted rolling machine. It is economical price.
Ground: Drill bits ground from the block with excellent surface quality.

** 135°split point: Ensure no walking and start fast, on contact.
M-shape: Designed to focus on drilling smoothly and speedily.

*** Non-ferrous metal (Such as Copper, Nickel and Zinc)

Drilling (Wood / Metal)

HSS-R Metal Drill bit

These items are available on request. Contact us for the minimum order quantity.

Two-star range



Roll forged HSS drill bit

Bit diameter (mm)	Overall length (mm)	Per pkg.	Part No.
5.2	86	1	D-46729
5.3	86	1	D-46947
6.8	109	1	D-46953
8.8	125	1	D-46969
10.3	133	1	D-46975
10.8	142	1	D-46981

HSS-G metal drill bit

Fully ground HSS drill bit

Three-star range



Bit diameter (mm)	Overall length (mm)	Working length (mm)	Per pkg.	Part No.
1.5	40	18	1	D-09656
2	49	24	1	D-09662
2.5	57	30	1	D-09678
2.9	61	33	1	D-46816
3	61	33	1	D-09684
3.2	65	36	1	D-46589
3.3	65	36	1	D-46595
3.5	70	39	1	D-09690
4	75	43	1	D-09709
4.2	75	43	1	D-46604
4.5	80	47	1	D-09715
5	86	52	1	D-09721
5.2	86	52	1	D-46610
5.3	86	52	1	D-46822
5.5	93	57	1	D-09737
6	93	57	1	D-09743
6.5	101	63	1	D-09759
6.8	109	69	1	D-46838
7	109	69	1	D-09765
7.5	109	69	1	D-09771
8	117	75	1	D-09787
8.8	125	81	1	D-46844
9	125	81	1	D-09802
9.5	125	81	1	D-09818
10	133	87	1	D-09824
10.3	133	87	1	D-46850
10.5	133	87	1	D-09830
10.8	142	94	1	D-46866
11	142	94	1	D-09846
11.5	142	94	1	D-09852
12	151	101	1	D-09868
12.5	151	101	1	D-09874
13	151	101	1	D-09880

HSS-G 5pcs, 10pcs. metal drill bit set

Three-star range



Bit diameter (mm)	Overall length (mm)	Working length (mm)	Per pkg.	Part No.
1.5	40	18	10	D-06236
1.75	46	22	10	D-06242
2	49	24	10	D-06258
2.25	53	27	10	D-06264
2.5	57	30	10	D-06270
2.75	61	33	10	D-06286
2.9	61	33	10	D-46648
3	61	33	10	D-06292
3.2	65	36	10	D-34942
3.25	65	36	10	D-06301
3.3	65	36	10	D-46567
3.5	70	39	10	D-06317
3.75	70	39	10	D-06323
4	75	43	10	D-06339
4.2	75	43	10	D-17762
4.25	75	43	10	D-06345
4.5	80	47	10	D-06351
4.75	80	47	10	D-06367
5	86	52	10	D-06373
5.2	86	52	10	D-34986
5.25	86	52	10	D-06389
5.5	93	57	10	D-06395
5.75	93	57	10	D-06404
6	93	57	10	D-06410
6.25	101	63	10	D-06426
6.5	101	63	10	D-06432
6.75	109	69	10	D-06448
7	109	69	10	D-06454
7.25	109	69	10	D-06460
7.5	109	69	10	D-06476
7.75	117	75	10	D-06482
8	117	75	10	D-06498
8.5	117	75	5	D-06513
8.75	125	81	5	D-06529
9	125	81	5	D-06535
9.5	125	81	5	D-06557
9.75	133	87	5	D-06563
10	133	87	5	D-06579
10.5	133	87	5	D-06591
11	142	94	5	D-06600
11.5	142	94	5	D-06616
12	151	101	5	D-06622
12.5	151	101	5	D-06638
13	151	101	5	D-06644

Drilling (Wood / Metal)

Double ended drill bit

Three-star range



Bit diameter (mm)	Overall length (mm)	Pc. per pkg.	Part No.
2	38	10	B-26652
2.5	43	10	B-33772
3	46	10	B-26668
3.1	49	10	B-26674
3.2	49	10	B-26680
3.3	49	10	B-26696
3.5	52	10	B-26705
3.8	55	10	B-26711
4	55	10	B-26727
4.1	55	10	B-26733
4.2	55	10	B-26749
4.3	55	10	B-26755
4.5	58	10	B-26761
4.8	62	10	B-26777
4.9	62	10	B-26783
5	62	10	B-26799
5.1	62	10	B-26808
5.2	62	10	B-26814
5.5	66	10	B-26820
6	66	10	B-26836
6.5	70	10	B-33788
8	79	10	B-26842
10	89	10	B-26858

HSS-TiN metal drill bit with 13mm straight shank

Three-star range



Bit diameter (mm)	Overall length (mm)	Pc. per pkg.	Part No.
14	160	1	D-65741
15	169	1	D-65757
16	178	1	D-65763
17	184	1	D-65779
18	191	1	D-65785
19	198	1	D-65791
20	205	1	D-65800

HSS-TiN metal drill bit with 1/4" Hex. shank

Fully ground HSS drill bit

Four-star range



Type NZ

Bit diameter (mm)	Length (mm)	Working length (mm)	Shank Type	Per pkg.	Part No.
2.5	78	30	NZ	1	D-46539
3	81	33	NZ	1	D-31114
3.3	85	36	NZ	1	D-31136
4	95	43	NZ	1	D-31142
4.2	95	43	NZ	1	D-31164
5	106	52	NZ	1	D-31170
5.2	106	52	NZ	1	D-46545
6	113	57	NZ	1	D-31186
6.5	121	63	NZ	1	D-31192
8	117	75	NZ	1	D-31201
10	133	87	NZ	1	D-31217
12	151	101	NZ	1	D-31223
13	151	101	NZ	1	D-31239

Rivet drill bit 1/4" Hex. shank

Fully ground HSS drill bit

Three-star range



Type MZ

Bit diameter (mm)	Length (mm)	Working length (mm)	Shank Type	Per pkg.	Part No.
3.3	50	25	MZ	5	B-38869

HSS Metal Drill Bit Assortment

M-Force HSS metal drill bit

Fully ground HSS drill bit

Four-star range



Bit diameter (mm)	Overall length (mm)	Working length (mm)	Per pkg.	Part No.
2	49	24	1	D-29614
2.5	57	30	1	D-29620
3	61	33	1	D-29636
3.2	65	36	1	D-37633
3.3	65	36	1	D-46626
3.5	70	39	1	D-29642
4	75	43	1	D-29658
4.2	75	43	1	D-37649
4.5	80	47	1	D-29664
5	86	52	1	D-29670
5.2	86	52	1	D-37655
5.5	93	57	1	D-29686
6	93	57	1	D-29692
6.5	101	63	1	D-29701
7	109	69	1	D-29717
7.5	109	69	1	D-29723
8	117	75	1	D-29739
8.5	117	75	1	D-29745
9	125	81	1	D-29751
9.5	125	81	1	D-29767
10	133	87	1	D-29773
10.5	133	87	1	D-29789
11	142	94	1	D-29795
11.5	142	94	1	D-29804
12	151	101	1	D-29810
12.5	151	101	1	D-29826
13	151	101	1	D-29832

HSS-Co metal drill bit (Cobalt 5%)

Fully ground HSS drill bit

Specialized



Bit diameter (mm)	Overall length (mm)	Working length (mm)	Per pkg.	Part No.
1.5	40	18	1	D-17289
2	49	24	1	D-17295
2.5	57	30	1	D-17304
3	61	33	1	D-17310
3.2	65	36	1	D-17326
3.3	65	36	1	D-46660
3.5	70	39	1	D-17332
4	75	43	1	D-17348
4.2	75	43	1	D-46676
4.5	80	47	1	D-17354
5	86	52	1	D-17360
5.2	86	52	1	D-46682
5.5	93	57	1	D-17376
6	93	57	1	D-17382
6.5	101	63	1	D-17398
7	109	69	1	D-17407
7.5	109	69	1	D-17413
8	117	75	1	D-17429
8.5	117	75	1	D-17435
9	125	81	1	D-17441
9.5	125	81	1	D-17457
10	133	87	1	D-17463
10.5	133	87	1	D-17479
11	142	94	1	D-17485
11.5	142	94	1	D-17491
12	151	101	1	D-17500
12.5	151	101	1	D-17516
13	151	101	1	D-17522

HSS-Co 5pcs. metal drill bit (Cobalt 5%)

Specialized



Bit diameter (mm)	Overall length (mm)	Working length (mm)	Per pkg.	Part No.
2	49	24	5	D-16623
2.5	57	30	5	D-16639
3	61	33	5	D-16645
3.3	65	36	5	D-46632
3.5	70	39	5	D-16667
4	75	43	5	D-16673
4.2	75	43	5	D-34958
4.5	80	47	5	D-16689
5	86	52	5	D-16695
5.2	86	52	5	D-34992
5.5	93	57	5	D-16704
6	93	57	5	D-16710
6.5	101	63	5	D-16726
7	109	69	5	D-16732

HSS Metal Drill Bit Assortment

Bit diameter (mm)	Overall length (mm)	Working length (mm)	Per pkg.	Part No.
8	117	75	5	D-16754
9	125	81	5	D-16776
9.5	125	81	5	D-16782
10	133	87	5	D-16798
10.5	133	87	5	D-16807
11	142	94	5	D-16813
11.5	142	94	5	D-16829
12	151	101	5	D-16835
12.5	151	101	5	D-16841
13	151	101	5	D-16857

HSS metal drill bit 5pcs. assortment

Fully ground HSS drill bit with bright edge and titanium coated flute finish
4 x 75, 5 x 86, 6 x 93, 8 x 117, 10 x 133mm (1pc. each)

Part No.
D-30514



M Force HSS metal drill assortment



Per pkg.	Set contents	Part No.
5pc. Assortment	4 x 75, 5 x 86, 6 x 93, 8 x 117, 10 x 133mm (1pc. each)	D-30508
19pc. Assortment	1pc each 1.0 to 10.0mm by 19ths	D-29876
25pc. Assortment	1pc each 1.0 to 13.0mm by 25ths	D-29882

HSS-Co metal drill bit assortment



Per pkg.	Set contents	Part No.
6pc. Assortment	2, 3, 4, 5, 6, 8mm (1pc.each)	D-57168

HSS Metal Drill Bit 19 pcs set

1 each 1.0 to 10.0mm by 19ths

Part No.
D-29941



HSS-Tin metal drill bit Economy type

Half ground, Tint coated

Four-star range



Bit diameter (mm)	Overall length (mm)	Working length (mm)	Per pkg.	Part No.
1	34	12	2	D-64004
1.5	40	18	2	D-64010
2	49	24	2	D-64026
2.5	57	30	2	D-64032
3	61	33	2	D-64048
3.5	70	39	2	D-64054
4	75	43	2	D-64060
4.5	80	47	1	D-64076
5	86	52	1	D-64082
5.5	93	57	1	D-64098
6	93	57	1	D-64107
6.5	101	63	1	D-64113
7	109	69	1	D-64129
7.5	109	69	1	D-64135
8	117	75	1	D-64141
8.5	117	75	1	D-64157
9	125	81	1	D-64163
9.5	125	81	1	D-64179
10	133	87	1	D-64185
10.5	133	87	1	D-64191
11	142	94	1	D-64200
11.5	142	94	1	D-64216
12	151	101	1	D-64222
12.5	151	101	1	D-64238
13	151	101	1	D-64244

Drilling (Wood / Metal)

Step drill bit

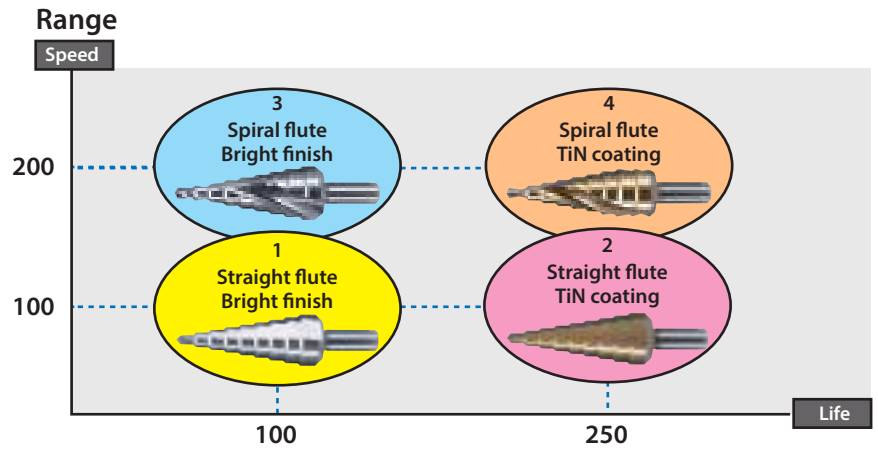
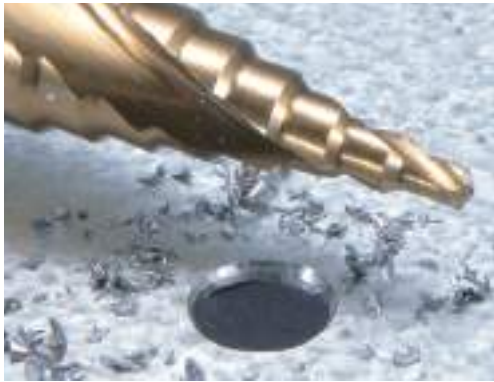

Material chart

AA: Recommended

A: Acceptable

Description	Flute	Surface	Shank	Material				
				Plastic	*Non-ferrous metal	Sheet steel	Alloy steel	Cast iron
1		Bright finish	Three flat or 1/4"Hex	AA	AA	AA	A	A
2		Titanium coating		AA	AA	AA	A	A
3		Bright finish		AA	AA	AA	A	A
4		Titanium coating		AA	AA	AA	A	A

*Non-ferrous metal (Such as Copper, Nickel and Zinc)

Countersink bit



Material chart

AA: Recommended

A: Acceptable

Description	Made of	Type	Shank	Material					
				Wood	Plastic	*Non-ferrous metal	Cast iron	Alloy steel	Stainless steel
7cutting edge 	Alloy steel 	 Shallow sinking	1/4"Hex	AA	AA	AA	AA		
5cutting edge 	High speed steel	Suitable for flat countersinking.	Straight shank	AA	AA	AA	AA	AA	
3cutting edge 	HSS 	 Deep sinking	1/4"Hex (C-form)	AA	AA	AA	AA	AA	
3cutting edge 		Suitable for deep countersinking.	Straight shank	AA	AA	AA	AA	AA	
Slanting hole It's for higher heat and abrasion resistance. Suitable for drilling tough metal.	High speed steel (Cobalt content 5%)	Shallow sinking Suitable for flat countersinking. Especially in thin metal sheets.	Straight shank		AA	AA	AA	AA	A

*Non-ferrous metal (Such as Copper, Nickel and Zinc)

Drill Bits

Step and Cone Drill Bit



Cone drill bit

These items are available on request. Contact us for the minimum order quantity.



Bit length (mm)	Overall length (mm)	Working length (mm)	Shank type	Per pkg.	Part No.
3-14	58	38	Straight (Three flat)	1	D-40048
4-20	71	51	Straight (Three flat)	1	D-40054

Step drill bit Straight flute Titanium coating

These items are available on request. Contact us for the minimum order quantity.

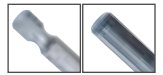

Bit length (mm)	Overall length (mm)	Working length (mm)	Shank type	Per pkg.	Part No.
4-12	65	45	1/4" Hex (MZ)	1	D-40113
4-20	75	53	1/4" Hex (MZ)	1	D-40129
4-32	102	80	Straight (Three flat)	1	D-40135

Cone drill bit

These items are available on request. Contact us for the minimum order quantity.



Bit length (mm)	Overall length (mm)	Working length (mm)	Shank type	Per pkg.	Part No.
16-30.5	76	51	Straight (Three flat)	1	D-40060
24-40	89	64	Straight (Three flat)	1	D-40076

Step drill bit Spiral flute

These items are available on request. Contact us for the minimum order quantity.



Bit length (mm)	Overall length (mm)	Working length (mm)	Shank type	Per pkg.	Part No.
4-12	65	45	1/4" Hex (MZ)	1	D-40141
4-20	75	53	1/4" Hex (MZ)	1	D-40157
4-32	102	80	Straight (Three flat)	1	D-40163

Step drill bit Straight flute

These items are available on request. Contact us for the minimum order quantity.



Bit length (mm)	Overall length (mm)	Working length (mm)	Shank type	Per pkg.	Part No.
4-12	65	45	1/4" Hex (MZ)	1	D-40082
4-20	75	53	1/4" Hex (MZ)	1	D-40098
4-32	102	80	Straight (Three flat)	1	D-40107

Step drill bit Spiral flute Titanium coating

These items are available on request. Contact us for the minimum order quantity.

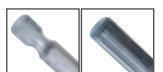















Bit length (mm)	Overall length (mm)	Working length (mm)	Shank type	Per pkg.	Part No.
4-12	65	45	1/4" Hex (MZ)	1	D-40179
4-20	75	53	1/4" Hex (MZ)	1	D-40185
4-32	102	80	Straight (Three flat)	1	D-40191

Countersink bit series

Material chart

AA: Recommended A: Acceptable

Description	A Made of	B Type	C Shank	Material					
				Wood	Plastic	Non-ferrous metal*	Cast iron	Alloy steel	Stainless steel
7cutting edge 			1/4"Hex	AA	AA	AA	AA		
3cutting edge 			1/4"Hex (C-form)	AA	AA	AA	AA	AA	
5cutting edge 			Straight shank	AA	AA	AA	AA	AA	
3cutting edge 			Straight shank	AA	AA	AA	AA	AA	
Slanting hole 			Straight shank		AA	AA	AA	AA	A

Non-ferrous metal (Such as Copper, Nickel and Zinc)

Countersink bit with seven 90° cutting edges

These items are available on request. Contact us for the minimum order quantity.



(1/4" Hex. shank)

Bit diameter (mm)	Overall length (mm)	Per pkg.	Application	Part No.
13	50	1	-	D-37306

Countersink bit with three 90° cutting edges

These items are available on request. Contact us for the minimum order quantity.



Bit diameter (mm)	Overall length (mm)	Per pkg.	Application	Part No.
6.3	45	1	M3	D-37437
8.3	50	1	M4	D-37443
10.4	50	1	M5	D-37459
12.4	56	1	M6	D-37465
16.5	60	1	M8	D-37471
20.5	63	1	M10	D-37487
25	67	1	M12	D-37493

Countersink bit with three 90° cutting edges

These items are available on request. Contact us for the minimum order quantity.



(1/4" Hex. shank)

Bit diameter (mm)	Overall length (mm)	Per pkg.	Application	Part No.
6.3	31	1	M3	D-37312
8.3	31	1	M4	D-37328
10.4	34	1	M5	D-37334
12.4	35	1	M6	D-37340
16.5	40	1	M8	D-37356
20.5	41	1	M10	D-37362

Slanting hole countersink bit



Bit diameter (mm)	Overall length (mm)	Per pkg.	Application	Part No.
2-5	45	1	-	D-37502
5-10	48	1	-	D-37518
10-15	65	1	-	D-37524
15-20	85	1	-	D-37530

Countersink bit with five 90° cutting edges

These items are available on request. Contact us for the minimum order quantity.



Bit diameter (mm)	Overall length (mm)	Per pkg.	Application	Part No.
6	48	1	M3	D-37378
8	48	1	M4	D-37384
10	40	1	M5	D-37390
12	40	1	M6	D-37409
16	42	1	M8	D-37415
20	45	1	M10	D-37421



Broach Cutter for Magnetic Drilling Machine

Broach Cutter



Short = 25mm Depth	
Diameter	Part No.
12mm Short	(MM)12S
13mm Short	(MM)13S
14mm Short	(MM)14S
15mm Short	(MM)15S
16mm Short	(MM)16S
17mm Short	(MM)17S
18mm Short	(MM)18S
19mm Short	(MM)19S
20mm Short	(MM)20S
21mm Short	(MM)21S
22mm Short	(MM)22S
23mm Short	(MM)23S
24mm Short	(MM)24S
25mm Short	(MM)25S
26mm Short	(MM)26S
27mm Short	(MM)27S
28mm Short	(MM)28S
29mm Short	(MM)29S
30mm Short	(MM)30S
31mm Short	(MM)31S
32mm Short	(MM)32S
33mm Short	(MM)33S
34mm Short	(MM)34S
35mm Short	(MM)35S
36mm Short	(MM)36S
37mm Short	(MM)37S
38mm Short	(MM)38S
39mm Short	(MM)39S
40mm Short	(MM)40S
41mm Short	(MM)41S
42mm Short	(MM)42S
43mm Short	(MM)43S
44mm Short	(MM)44S
45mm Short	(MM)45S
46mm Short	(MM)46S
47mm Short	(MM)47S
48mm Short	(MM)48S
49mm Short	(MM)49S
50mm Short	(MM)50S

Long = 50mm Depth	
Diameter	Part No.
12mm Long	(MM)12L
13mm Long	(MM)13L
14mm Long	(MM)14L
15mm Long	(MM)15L
16mm Long	(MM)16L
17mm Long	(MM)17L
18mm Long	(MM)18L
19mm Long	(MM)19L
20mm Long	(MM)20L
21mm Long	(MM)21L
22mm Long	(MM)22L
23mm Long	(MM)23L
24mm Long	(MM)24L
25mm Long	(MM)25L
26mm Long	(MM)26L
27mm Long	(MM)27L
28mm Long	(MM)28L
29mm Long	(MM)29L
30mm Long	(MM)30L
31mm Long	(MM)31L
32mm Long	(MM)32L
33mm Long	(MM)33L
34mm Long	(MM)34L
35mm Long	(MM)35L
36mm Long	(MM)36L
37mm Long	(MM)37L
38mm Long	(MM)38L
39mm Long	(MM)39L
40mm Long	(MM)40L
41mm Long	(MM)41L
42mm Long	(MM)42L
43mm Long	(MM)43L
44mm Long	(MM)44L
45mm Long	(MM)45L
46mm Long	(MM)46L
47mm Long	(MM)47L
48mm Long	(MM)48L
49mm Long	(MM)49L
50mm Long	(MM)50L

Broach Cutter Pilot Pin



Pilot pin	Part No.
25mm	(MM)PILOT S
50mm	(MM)PILOT L











Chuck Adapter for Pilot Pin



For use with	Part No.
standard drill chuck	MMCHU03

Drilling (Wood / Metal)

Wood drill bit series

	Description	Point	shank	Diameter
Wood drill bit 	This is the most popular drill in wood drill and suitable for drilling holes with small to medium diameter. Able to drill soft plastics other than general wood. Highly effective for boring more clean and precise holes than flat bit.		Straight 	3 - 20mm 1/8" - 3/4"
			1/4"Hex 	3 - 15mm
Single spur auger bit 	Suitable for drilling of deep holes with medium to large diameters holes in soft and hard wood. Threaded screw point pull the bit into the work piece providing a fast, easy to use self feeding action. Highly effective for boring more clean and precise holes than flat bit or wood drill.		Hex 	6 - 30mm 1/4" - 1-1/4"
			1/4"Hex 	6 - 21mm
Ship auger bit 	Suitable for knotty nail embedded wood which unable to drill with single spur. Suitable for plumbing and electrical installation, etc.		5/16" & 7/16" Hex 	10 - 38mm 3/8" - 1-1/2"

Wood drill bit



Bit diameter (mm)	Overall length (mm)	Working length (mm)	Part No.
3	60	33	D-07026
4	75	43	D-07032
5	85	52	D-07048
6	95	57	D-07054
7	110	69	D-07060
8	115	75	D-07076
9	125	81	D-07082
10	135	87	D-07098
12	155	101	D-07107
13	151	96	D-53453
14	170	108	D-07113
15	160	100	D-53469
16	180	105	D-07129
18	200	120	D-07135
20	200	130	D-07141
6	315	160	D-07157
8	315	160	D-07163
10	315	160	D-07179
12	315	160	D-07185
14	315	160	D-07191
16	315	160	D-07200
18	335	160	D-07216
20	335	160	D-07222

Brad point wood drill bit with 1/4" Hex. shank



Type NZ

Bit diameter (mm)	Overall length (mm)	Working length (mm)	Shank Type	Per pkg.	Part No.
3	78	33	NZ	1	D-31245
4	92	43	NZ	1	D-31251
5	103	52	NZ	1	D-31267
6	110	57	NZ	1	D-31273
8	117	75	NZ	1	D-31289
10	133	87	NZ	1	D-31295
12	151	101	NZ	1	D-31304
15	162	108	NZ	1	D-31310

Single spur Auger bit with straight shank



Bit diameter (mm)	Overall length (mm)	Working length (mm)	Part No.
6	200	130	D-07238
8	200	130	D-07244
12	200	130	D-07266
14	200	130	D-07272
16	200	130	D-07288

Drilling (Wood / Metal)

Bit diameter (mm)	Overall length (mm)	Working length (mm)	Part No.
18	200	130	D-07294
20	200	130	D-07303
22	200	130	D-07319
24	200	130	D-07325
6	250	180	D-07331
8	250	180	D-07347
10	250	180	D-07353
12	250	180	D-07369
14	250	180	D-07375
16	250	180	D-07381
18	250	180	D-07397
20	250	180	D-07406
22	250	180	D-07412
24	250	180	D-07428

Ship Auger bit with 7/16" Hex. Shank



*5/16" Hex. Shank
Nail cutting type

Bit diameter (mm)	Overall length (mm)	Working length (mm)	Part No.
10	165	90	*D-36055
12	165	90	*D-36061
14	165	90	D-36077
16	165	90	D-36083
18	165	90	D-36099
20	165	90	D-36108
22	165	90	D-36114
24	165	90	D-36120
26	165	90	D-36136
28	165	90	D-36142
30	165	90	D-36158
32	165	90	D-36164
35	165	90	D-36170
38	165	90	D-36186

Auger bit with 1/4" Hex. shank



Type NZ

Bit diameter (mm)	Overall length (mm)	Working length (mm)	Shank Type	Per pkg.	Part No.
6	200	130	NZ	1	D-31326
8	200	130	NZ	1	D-31332
10	200	130	NZ	1	D-31348
12	200	130	NZ	1	D-31354
14	200	130	NZ	1	D-31360
16	200	130	NZ	1	D-31376
18	200	130	NZ	1	D-31382
20	200	130	NZ	1	D-31398
21	200	130	NZ	1	D-31407

T.C.T. Hinge cutting bit



Diameter (mm)	Overall length (mm)	Shank Size (mm)	Per pkg.	Part No.
15	77	6.5	1	D-71093
19	77	6.5	1	D-71102
20	77	6.5	1	D-71118
25	77	7.5	1	D-71124
26	77	7.5	1	D-71130
30	77	8.0	1	D-71146
32	77	8.0	1	D-71152
35	77	9.0	1	D-71168

Formwork drill bit



Bit diameter (mm)	Overall length (mm)	Working length (mm)	Per pkg.	Part No.
8	400	75	1	D-70219
10	400	87	1	D-70225
12	400	101	1	D-70231
14	400	108	1	D-70247
16	400	100	1	D-70253
18	400	100	1	D-70269
20	400	100	1	D-70275
22	400	100	1	D-70281
24	400	100	1	D-70297
26	400	100	1	D-70306
28	400	100	1	D-70312
30	400	100	1	D-70328
8	600	75	1	D-70334
10	600	87	1	D-70340
12	600	101	1	D-70356
14	600	108	1	D-70362
16	600	100	1	D-70378
18	600	100	1	D-70384
20	600	100	1	D-70390
22	600	100	1	D-70409
24	600	100	1	D-70415
26	600	100	1	D-70421
28	600	100	1	D-70437
30	600	100	1	D-70443

Drilling (Wood / Metal)

Holesaw

Ezychange BiM Holesaw



BiM Holesaw



BiM Holesaw for sheet metal

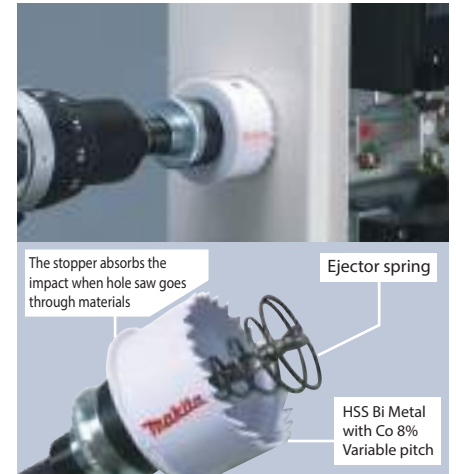

Multi purpose TCT Holesaw



TCT Holesaw

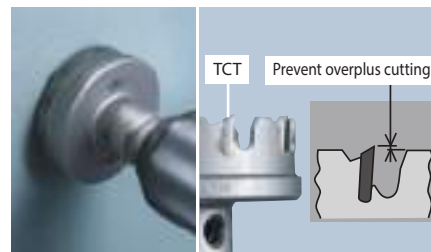







TCT grit Hole saw



Material chart

AA : Recommended

A : Acceptable

Application	Steel	Inox Stainless	Aluminum	Non ferrous Metal	Wood	MDF	PLASTER BOARD	PVC	FRP	SOFT TILE	Brick	Lime stone	Marble
Ezy BiM 	AA	A	AA	AA	A			AA					
BiM 	AA		A	A	AA			AA					
BiM for sheet metal 	AA	AA	A	A									
Multi purpose TCT 					AA	AA	AA	AA	AA	A	A	A	
TCT 	AA	AA	A	A				AA	AA				
TC grit 										AA	AA		
Vacuum brazed Diamond 										AA	AA	AA	AA

Drilling (Wood / Metal)

Ezychange BiM Holesaw

Tool-less change of pilot drill and holesaw (dia.14-152mm) in the Ezychange adaptor.



Ezychange

Type NZ

Size (mm)	Working length (mm)	Part No.	Size (mm)	Working length (mm)	Part No.
16	40	B-11265	56	40	B-31756
17	40	B-31706	57	40	B-11411
19	40	B-11271	60	40	B-11427
20	40	B-11287	64	40	B-11433
22	40	B-11293	68	40	B-11449
24	40	B-11302	70	40	B-11455
25	40	B-11318	73	40	B-31762
27	40	B-31712	76	40	B-11461
29	40	B-11324	79	40	B-31778
30	40	B-11330	83	40	B-11477
32	40	B-11346	86	40	B-31784
35	40	B-11352	92	40	B-11483
37	40	B-31728	95	40	B-31790
38	40	B-11368	102	40	B-11499
41	40	B-11374	105	40	B-11508
44	40	B-11380	111	40	B-31809
46	40	B-31734	114	40	B-31815
48	40	B-11396	121	40	B-31821
51	40	B-11405	127	40	B-11514
52	40	B-31740	140	40	B-31837
54	40	B-18194	152	40	B-11520

or Ezychange BiM Holesaw

Pilot drill



Adapter



Description	Part No.
Ezychange Adapter + HSS-G Pilot Drill Bit	B-11536
HSS-G Pilot Drill Bit	B-11542
Ezychange SDS plus Adapter without Pilot Drill	B-31902

Hole Saw

(1/4" Hex Shank)



Recommended for cutting steel plates, aluminum, wood and plastic up to 1.6mm in thickness.

For Model	Hole Saw dia.	Part No.
Impact Drivers Driver Drills Drills	12mm	A-31968
	13mm	A-31974
	14mm	A-31980
	15mm	A-31996
	16mm	A-32007
	17mm	A-32116
	18mm	A-32122
	19mm	A-32138
	20mm	A-32144
	21mm	A-32150
	22mm	A-32166
	23mm	A-32172
	24mm	A-32188
	25mm	A-32194
	26mm	A-32203
	27mm	A-32219
	28mm	A-32225
	29mm	A-32231
	30mm	A-32247
	31mm	A-32253
32mm	A-32269	
33mm	A-32275	
34mm	A-32281	
35mm	A-32297	
36mm	A-32306	
37mm	A-32312	
38mm	A-32328	

TCT Hole saw & Center drill

High quality carbide tips brazed on to the cutting edge enable high speed drilling of material up to 4mm in thickness with no coolant required.

Carbide tips are random-spaced to reduce chattering noise.

Not for percussion / hammering applications.



Hole saw

Bit diameter (mm)	Shank dia (mm)	Part No.	Bit diameter (mm)	Shank dia (mm)	Part No.
16	6	B-00898	65	13	B-01074
25	10	B-00941	80	13	B-01105
30	10	B-00979	100	13	B-01149
50	10	B-01046	110	13	B-01155

Drilling (Wood / Metal)

BiM Hole saw

Hole saws have 4/6 variable pitch tooth design and are recommended for cutting, steel plates, aluminium, copper, brass, wood and plastic.



Working length: 38mm

Size (mm)	Working length (mm)	Part No.	Size (mm)	Working length (mm)	Part No.
14	38	D-35368	59	38	D-35499
16	38	D-16994	60	38	D-25688
17	38	D-35374	64	38	D-30140
19	38	D-17005	65	38	D-24882
20	38	D-17251	67	38	D-35508
21	38	D-35380	68	38	D-17108
22	38	D-17011	70	38	D-25694
24	38	D-17027	73	38	D-35514
25	38	D-17033	76	38	D-17114
27	38	D-35396	79	38	D-35520
29	38	D-17267	80	38	D-33869
30	38	D-35405	83	38	D-17120
32	38	D-17049	86	38	D-35536
33	38	D-35411	89	38	D-35542
35	38	D-17055	92	38	D-17136
38	38	D-17061	95	38	D-35558
40	38	D-17273	98	38	D-35564
41	38	D-35433	102	38	D-35570
43	38	D-35449	105	38	D-17142
44	38	D-17077	108	38	D-35586
46	38	D-35455	111	38	D-35592
48	38	D-35461	114	38	D-35601
51	38	D-17083	121	38	D-35617
52	38	D-35477	127	38	D-17158
54	38	D-24876	140	38	D-35623
56	38	D-35483	152	38	D-17164
57	38	D-17099			

Accessories for BiM Hole saw

Pilot drill



Adapter



Application	Fits hole saws	Part No.
Adapter with Pilot drill		
For 10mm Drill	14 -29mm	D-17170
For 13mm Drill	32 -152mm	D-17186
For SDS-Plus Hammer	14 -29mm	D-17603
For SDS-Plus Hammer	32 -76mm	D-17619
Pilot drill		
Length 71mm	All	D-17192

Accessories for BiM Hole saw

Pilot drill



Application	Fits hole saws	Part No.
Length 71mm	All	D-17192

BiM Hole saw assortment

Most six common sizes for Plumber & Electrician.

A: 11mm (*7/16") Adapter with Pilot Drill

B: 9.5mm (*3/8") Adapter with Pilot Drill

C: Ejector spring



Suitable for	Included Hole saws (1 each)	Part No.
For Plumber	19,22,29,38,44,57mm,adapter A, adapter B, ejector spring	D-47117
For Electrician	16,20,25,32,40,51mm,adapter A, adapter B, ejector spring	D-47123
For Electrician	20,25,32,40,51,65mm,adapter A, adapter B, ejector spring	D-47139

Vacuum brazed diamond Holesaw



Use with shank with Pilot Drill

Bit diameter (mm)	Working length (mm)	Part No.	Bit diameter (mm)	Working length (mm)	Part No.
16	40	B-45995	38	40	B-46056
19	40	B-46006	45	40	B-46062
25	40	B-46012	50	40	B-46078
30	40	B-46028	53	40	B-46084
32	40	B-46034	57	40	B-46090
35	40	B-46040	64	40	B-46109

Accessories for vacuum brazed diamond Holesaw

Accessories for Vacuum brazed diamond holesaw

Shank with Pilot Drill



SDS-Plus with Pilot Drill



Pilot Drill



Application	Type of pilot drill	Fits hole saws	Part No.
Shank with Pilot Drill			
for 13mm drill	TCT	All	B-46115
SDS-PLUS	TCT	All	B-52691
Pilot Drill			
SDS-PLUS / 13mm drill	TCT	All	B-46121

ACCESSORIES

▣ Drilling (Masonry)



For SDS-PLUS Hammers



For SDS-MAX Hammers



17 mm Hex



19 mm Hex



21mm Hex



28.6mm Hex



30mm Hex



Makita Small

Drilling (Masonry)

Straight shank

Straight shank Tungsten carbide-tipped bit
(Masonry drill bit)



*(Masonry Drill Bit 5pc Assortment) 5 different sizes.

Bit diameter (mm)	Length (mm)	Part No.
3	60	D-05228
4	70	D-05234
5	85	D-05240
6	100	D-05256
6	150	D-05262
7	100	D-05278
7	150	D-05284
8	110	D-05290
8	150	D-05309
9	150	D-05315
10	150	D-05321
11	150	D-05337
12	150	D-05343
13	150	D-05359
16	150	D-05387
16	400	D-17706

TCT drill bit 1/4" Hex. shank



1/4"Hex (NZ)

Bit diameter (mm)	Overall length (mm)	Working length (mm)	Shank type	Per pkg.	Part No.
3	80	35	NZ	1	D-31463
4	80	35	NZ	1	D-31479
6	100	55	NZ	1	D-31491
8	100	55	NZ	1	D-31500

Omnibohrer Straight shank

(Multi purpose drill bit)

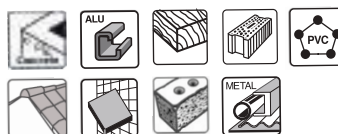

Can drill multiplicity of materials without changing drill bit (ideal for doors, shelves, window frames etc). Use with rotary or percussion drills. Without percussion use on vitrified brick, wood, brick. With percussion use on block, stone, plaster most grades of concrete.

TCT drill bit Straight shank 5pcs set

*5 different sizes



Bit diameter (mm)	Overall length (mm)	Working length (mm)	Part No.
4	70	35	D-05175
5	85	45	
6, 8, 10	100	60	*D-20719
5, 6, 7, 8, 10	110	60	

Bit diameter (mm)	Length (mm)	Part No.
3	60	D-30287
4	70	D-30293
5	85	D-30302
5.5	85	D-31027
5.5	100	D-31033
5.5	150	D-31049
6	100	D-30318
6	150	D-30324
6.5	85	D-31055
6.5	100	D-31061
6.5	150	D-31077
7	100	D-30330
7	150	D-30346
8	110	D-30352
8	150	D-30368
9	150	D-30374
10	150	D-30380
10	400	D-30396
11	150	D-30405
12	150	D-30411
12	400	D-30427
12	600	D-30433
13	150	D-30449
14	150	D-30455
14	400	D-30461

Drilling (Masonry)

Omnibohrer straight shank 5pcs set



Bit diameter (mm)	Length (mm)	Working length (mm)	Part No.
5	85	41	D-30477
6	100	56	
8	110	55	
10	150	95	
12	150	91	
4	70	36	D-36712
5	85	41	
6	100	56	
8	150	95	
10	150	95	

Glass bit Straight shank



Bit diameter (mm)	Overall length (mm)	Shank Type	Per pkg.	Part No.
3	65	Straight	1	D-25111
4	65	Straight	1	D-25127
5	65	Straight	1	D-25133
6	65	Straight	1	D-25149
8	70	Straight	1	D-25155
10	80	Straight	1	D-25161
12	80	Straight	1	D-25177

Glass bit 1/4" Hex. Shank



1/4"Hex (NZ)

Bit diameter (mm)	Overall length (mm)	Shank Type	Per pkg.	Part No.
4	65	NZ	1	D-31413
5	65	NZ	1	D-31429
6	65	NZ	1	D-31435
8	70	NZ	1	D-31441
10	80	NZ	1	D-31457

Masonry drill bit for brick



Bit diameter (mm)	Overall length (mm)	Pc. per pkg.	Part No.
3.5	75	1	D-40733
4.5	85	1	D-40755
5	85	1	D-40761
5.5	150	1	D-40799
6	400	1	D-40836
6.5	100	1	D-40842
6.5	150	1	D-40858
6.5	400	1	D-40864
7	400	1	D-40892
8	400	1	D-40939
10	150	1	D-40967
10	200	1	D-40973
10	400	1	D-40989
12	200	1	D-41012
12	400	1	D-41028









Masonry drill bit for brick assortment



Bit diameter (mm)	Overall Length (mm)	Part No.
5	85	D-41034
6	100	
8	12	
4	75	D-41040
5	85	
6	100	
8	120	
10	120	
3	60	D-41791
4	75	
5	85	
6	100	
7	100	
8	120	
9	120	
10	120	

Drilling (Masonry)

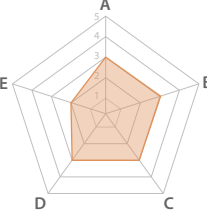
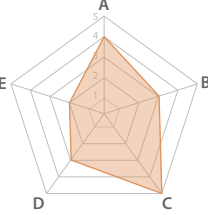
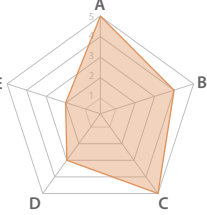
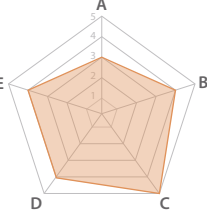
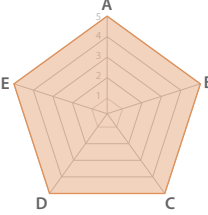
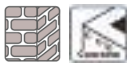
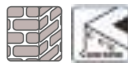
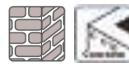
TCT drill bit for SDS-PLUS Hammers Chart

Product	Standard type	Centering Tip	Centering Tip V-PLUS	4 cutter	NEMESIS II
Range	★ ★	★ ★ ★	★ ★ ★ ★	★ ★ ★	★ ★ ★ ★ ★
Carbide					
Tip	2 Cutter	Centering tip 2 Cutter	Centering tip 2 Cutter	Centering tip 4 Cutter	Full carbide tip 4 Cutter 
Flute	Standard 2 flute	Standard 2 flute	High Durability 2 flute	Standard 2 flute	High Durability 4 flute
Size	3.5 - 30mm 5/32" - 1"	4 - 32mm 5/32" - 1"	4 - 32mm	5 - 25mm	5 - 32mm 5/32" - 1-1/4"
Chart					
Work material					

NEMESIS II

ALL NEW!!

NEMESIS II for SDS-PLUS Hammers

With Solid Carbide head



Lifetime on rebar up to 50% higher!

Utility



Wearing mark
Indicator for evaluating the dimensional stability of the anchor holes

Innovated flute geometry
Faster drilling

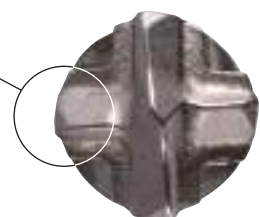

Rebar chamfer
Reduce shock in reinforcement strikes

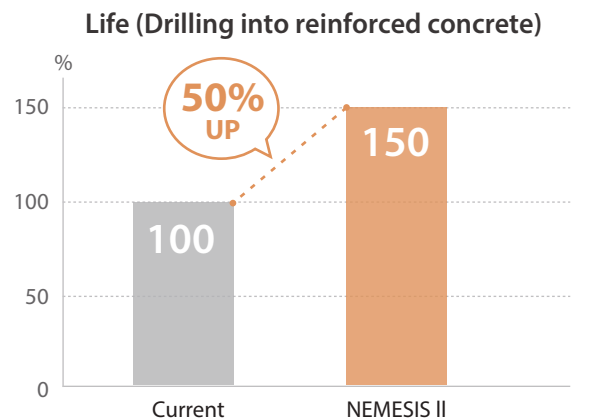

Drilling (Masonry)

Tools for SDS-PLUS Hammers



nemesis II drill bit for SDS-PLUS Hammers

- *One piece solid carbide tip (5-10mm)
- *No seizing up on hitting reinforcing steel
- *Ensure precision drill holes
- *Drills more precisely
- *Low vibration and high fracture resistance



Five-star range



Bit diameter (mm)	Overall length (mm)	Working length (mm)	Part No.
5	115	50	B-57897
5	165	100	B-57906
5.5	115	50	B-57940
5.5	165	100	B-57956
6	115	50	B-57962
6	165	100	B-57978
6	215	150	B-57984
6	265	200	B-57990
6	315	250	B-58001
6.5	165	100	B-58023
6.5	215	150	B-58039
6.5	265	200	B-58045
6.5	315	250	B-58051
7	115	50	B-58067
7	165	100	B-58073
8	115	50	B-58095
8	165	100	B-58104
8	215	150	B-58110
8	265	200	B-58126
8	315	250	B-58132
9	165	100	B-58176
10	115	50	B-58198
10	165	100	B-58207
10	215	150	B-58213
10	265	200	B-58229
10	315	250	B-58235
10	455	390	B-58257
10	600	540	B-58263
10	1000	940	B-58279
12	160	110	B-58322
12	210	160	B-58338
12	260	210	B-58344
12	310	260	B-58350
12	450	400	B-58366
12	600	550	B-58372
12	1000	950	B-58388
14	160	110	B-58431
14	210	160	B-58447
14	260	210	B-58453
14	310	260	B-58469

Bit diameter (mm)	Overall length (mm)	Working length (mm)	Part No.
14	450	400	B-58475
14	600	550	B-58481
14	1000	950	B-58497
15	160	110	B-58506
15	210	160	B-58512
15	260	210	B-58528
15	450	400	B-58534
16	160	110	B-58540
16	210	160	B-58556
16	260	210	B-58562
16	310	260	B-58578
16	450	400	B-58584
16	600	550	B-58590
16	1000	950	B-58609
18	250	200	B-58615
18	450	400	B-58621
20	250	200	B-58637
20	450	400	B-58659
22	250	200	B-58665
22	450	400	B-58687
24	250	200	B-58693
24	450	400	B-58702
25	250	200	B-58718
25	450	400	B-58724
28	250	200	B-58746
28	450	400	B-58752
30	250	200	B-58768
30	450	400	B-58774
32	450	400	B-58780

T.C.T drill bit for SDS-PLUS hammers/ 4 cutter



Three-star range



Bit diameter (mm)	Overall length (mm)	Working length (mm)	Part No.
5	110	50	B-68127
5	160	100	B-68133
5	210	150	B-68149
5	260	200	B-68155
6	110	50	B-62496
6	160	100	B-62505
6	210	150	B-62511
6	260	200	B-62527
6	310	250	B-68161
6.5	110	50	B-62533
6.5	160	100	B-62549
6.5	210	150	B-62555
6.5	260	200	B-62561
7	110	50	B-62577
7	160	100	B-62583
7	210	150	B-62599
8	110	50	B-62608
8	160	100	B-62614
8	210	150	B-62620
8	260	200	B-62636
8	310	250	B-62642
8	460	400	B-62658
10	110	50	B-62664
10	160	100	B-62670

Drilling (Masonry)

Bit diameter (mm)	Overall length (mm)	Working length (mm)	Part No.
10	210	150	B-62686
10	260	200	B-62692
10	310	250	B-62701
10	350	290	B-62717
10	460	400	B-62723
12	160	100	B-62739
12	210	150	B-62745
12	260	200	B-62751
12	310	250	B-62767
12	350	290	B-62773
12	460	400	B-62789
14	160	100	B-62795
14	210	150	B-62804
14	260	200	B-62810
14	310	250	B-62826
14	350	290	B-62832
14	460	400	B-62848
16	160	100	B-62854
16	210	150	B-62860
16	260	200	B-62876
16	310	250	B-62882
16	350	290	B-62898
16	460	400	B-62907
18	260	200	B-68177
18	460	400	B-68236
20	260	200	B-68183
20	460	400	B-68242
22	260	200	B-68199
22	460	400	B-68258
25	260	200	B-68208
25	460	400	B-68264

Bit diameter (mm)	Overall length (mm)	Working length (mm)	Part No.
10	310	250	B-56007
12	160	100	B-54215
12	210	150	B-54221
12	260	200	B-56029
12	350	290	B-56035
13	160	100	B-56057
14	160	100	B-56063
14	260	200	B-56085
14	350	290	B-56091
16	160	100	B-56116
16	210	150	B-56122
16	310	250	B-56138
16	350	290	B-56144
16	460	400	B-56150
17	210	150	B-56465
18	210	150	B-62125
18	350	290	B-62131
19	210	150	B-62147
20	210	150	B-62169
20	350	290	B-62175
22	210	150	B-62181
22	350	290	B-62197
25	210	150	B-62228
25	350	290	B-62234

Centering Tip drill bit for SDS-PLUS Hammers



Three-star range



Bit diameter (mm)	Overall length (mm)	Working length (mm)	Part No.
4	110	50	B-55859
5	110	50	B-54128
5	160	100	B-54134
5.5	110	50	B-55865
5.5	160	100	B-55871
6	110	50	B-54140
6	160	100	B-54156
6	210	150	B-54162
6.5	110	50	B-55887
6.5	160	100	B-55893
7	110	50	B-55924
7	160	100	B-55930
8	110	50	B-54178
8	160	100	B-54184
8	210	150	B-55952
8	260	200	B-55968
9	160	100	B-55974
10	110	50	B-55980
10	160	100	B-54190
10	210	150	B-54209
10	260	200	B-55996

Tungsten carbide-tipped bit



Bit diameter (mm)	Length (mm)	Part No.
3.5	110	D-15665
4	110	D-00016
4	160	D-66612
5	110	D-00022
5	160	D-00038
5	210	D-66628
5.5	110	D-00044
5.5	160	D-16106
6	110	D-00050
6	160	D-00066
6	210	D-00072
6.5	110	D-00088
6.5	160	D-00094
6.5	210	D-45082
6.5	260	D-66634
7	110	D-00103
7	160	D-00119
8	110	D-00125
8	160	D-00131
8	210	D-00147
8	260	D-00153
8	310	D-66640
9	110	D-08040
9	160	D-08056
9	210	D-00169
10	110	D-09117
10	160	D-00175
10	210	D-00181
10	260	D-00197
10	310	D-00206

Drilling (Masonry)

Bit diameter (mm)	Length (mm)	Part No.
10	350	D-66656
11	160	D-00212
11	160	D-00228
11	210	D-66662
11	260	D-66678
12	210	D-00234
12	260	D-00240
12	310	D-66684
12	350	D-16112
12	460	D-16271
12.5	160	D-14102
12.7	160	D-03280
12.7	350	D-03296
13	160	D-00256
13	210	D-66690
13	260	D-25622
13	350	D-16128
14	160	D-00262
14	210	D-21331
14	260	D-00278
14	310	D-66709
14	350	D-16134
14.3	160	D-03997
15	160	D-00284
15	350	D-16140
16	160	D-03981
16	210	D-00290
16	260	D-16156
16	310	D-00309
16	350	D-16162
16	460	D-16287
17	160	D-16178
17	210	D-00315
17	350	D-16190
17.5	160	D-03305
18	160	D-16209
18	210	D-00321
18	260	D-16215
18	300	D-00337
18	350	D-16221
18	460	D-17566
19	210	D-00343
19	350	D-16243
20	210	D-00359
20	260	D-16259
20	310	D-00365
20	350	D-16265
20	460	D-15235
22	260	D-00371
22	310	D-08062
22	460	D-15241
24	460	D-16302
25	260	D-00387
25	310	D-08517
25	350	D-03311
25	460	D-15257
26	260	D-00393
26	310	D-08078
26	460	D-15263
28	460	D-16318
30	460	D-17572

Dust extraction drill bit for SDS-Plus Hammers



Bit diameter (mm)	Overall length (mm)	Working length (mm)	Part No.
12	325	200	B-64381
14	360	240	B-64397
16	360	240	B-64406
18	360	240	B-64412

TCT drill bit for SDS-PLUS Hammers 5pcs set

(5 different sizes)



* (6 x 160 2pc. 8 x 160 2pc.)
** (6 x 160 2pc.)

Bit diameter (mm)	Overall length (mm)	Working length (mm)	Part No.
5, 6, 8	110	50	D-00795
6, 8	160	100	
5.5, 7	110	50	D-03888
6, 7, 8	160	100	
6, 6.5	110	50	D-17784
8, 10, 12	160	100	
5, 6, 7, 8, 10	160	100	D-20703

TCT drill bit & Chisel for SDS-PLUS Hammers 6pcs set



Bit diameter (mm)	Overall length (mm)	Working length (mm)	Part No.
5, 6, 8	160	100	D-58920
Bull Point 250			
Cold Chisel 20x250			
Scaling Chisel 40x250			

Drilling (Masonry)

TCT drill bit & Chisel for SDS-PLUS Hammers set (with aluminum case)



10pc. assortment

Description	Part No.
6 x110, 8x160, 10, 12x210, 10, 12, 16, 20x460,	D-19174
Bull Point 250	
Cold Chisel 20x250	

17pc. assortment

Description	Part No.
5, 6, 8, 10x110, 6, 8, 10, 12x160, 8, 10x210, 12, 14x260	D-19180
Bull Point 140, 250	
Cold Chisel 20x140, 20x250	
Scaling Chisel 40x250	

18pc. assortment

Description	Part No.
SDS-Plus Drill Bit 5 x110, 6 x110, 8 x110, 10 x110, 6 x160, 8 x160, 10 x160, 12 x160, 8 x 210, 10 x 210, 10 x260, 12 x260	D-71180
Bull Point 140, 250	
Cold Chisel 20x140, 20x250	
Scaling Chisel 40x250	
Drill Chuck & Chuck Key 13mm	

Tools for SDS-MAX Hammers



nemesis MAX drill bit for SDS-MAX Hammers

- *Massive carbide tip provides optimal drilling performance
- *No seizing up on hitting reinforcing steel
- *Ensure precision drill holes
- *Drills more precisely
- *Low vibration and high fracture resistance



Four-star range



Bit diameter (mm)	Overall length (mm)	Working length (mm)	Type	Part No.
16	540	400	4 cutter head	B-19978
18	540	400	4 cutter head	B-20002
20	520	400	4 cutter head	B-20030
22	520	400	4 cutter head	B-20068
25	320	200	4 cutter head	A-17550
25	520	400	4 cutter head	B-20111
30	370	250	4 cutter head	B-20183
30	570	450	4 cutter head	B-20199
32	370	250	4 cutter head	A-17572
32	570	450	4 cutter head	B-20214
35	370	250	4 cutter head	A-17588
38	370	250	4 cutter head	A-17594
40	570	450	4 cutter head	B-20301

Drilling (Masonry)

Nemesis II SDS-Plus hammer assortment set



Bit diameter (mm)	Overall length (mm)	Working length (mm)	Part No.
5,6,8	110	60	B-58986
5,6	110	60	B-58992
6,8,10	160	110	
5,5,7	110	60	B-59003
6,7,8	160	110	

Nemesis II SDS-Plus hammer pack



Bit diameter (mm)	Overall length (mm)	Working length (mm)	Pc. Per pkg	Part No.
5	115	50	5	B-58796
5.5	115	50	5	B-58805
6	115	50	5	B-58811
6	165	100	5	B-58827
6.5	165	100	5	B-58849
8	115	50	5	B-58883
8	165	100	5	B-58899
10	165	100	5	B-58914
10	215	150	5	B-58920
12	160	110	5	B-58936
12	210	160	5	B-58942
5	115	50	10	B-63214
5	165	100	10	B-63220
5.5	115	50	10	B-63236
5.5	165	100	10	B-63242
6	115	50	10	B-63258
6	165	100	10	B-63264
6.5	165	100	10	B-63301
8	115	50	10	B-63367
8	165	100	10	B-63373
10	165	100	10	B-63410
10	215	150	10	B-63426
12	160	110	10	B-63454
12	210	160	10	B-63460
14	160	110	10	B-63498

T.C.T Drill Bit for SDS Max Hammer

For Model: HR3540C, HR3541FC, HR4001C, HR4002, HR4010C, HR4011C, HR4501C, HR4510C, HR4511C, HR5201C, HR5210C, HR5211C



Tungsten carbide-tipped bit



Bit diameter (mm)	Length (mm)	Type	Part No.
12	340	2 cutter	D-33875
12	540	2 cutter	D-33881
12	540	2 cutter	P-17049
14	340	2 cutter	D-33897
14	540	2 cutter	D-33906
15	340	2 cutter	D-33912
16	340	2 cutter	D-33934
16	540	2 cutter	D-33940
16	540	2 cutter	P-77746
18	340	2 cutter	D-33956
20	340	2 cutter	D-33978
20	540	2 cutter	D-33984
22	340	2 cutter	D-33990
22	540	2 cutter	D-34001
24	340	2 cutter	D-34017
24	520	2 cutter	P-17251
24	540	2 cutter	D-34023
25	340	2 cutter	D-34039
25	540	2 cutter	D-34045
28	370	2 cutter	D-34051
28	570	2 cutter	D-34067
30	370	2 cutter	D-34073
32	370	2 cutter	D-34095
35	370	2 cutter	D-34110
35	570	2 cutter	P-17382
38	370	2 cutter	D-34132
38	570	2 cutter	D-34148
40	370	2 cutter	D-34154

Drilling (Masonry)

TCT drill bit for mining (for SDS-MAX Hammers)

*Suitable for drilling into hard rock
*Resharpenable



Bit diameter (mm)	Overall length (mm)	Working length (mm)	Type	Part No.
32	570	450	Mining	B-14613
32	920	800	Mining	B-15045

SDS-PLUS HSS-TiN metal drill bit

Fully ground HSS drill bit



Size: mm

Bit diameter (mm)	Overall length (mm)	Working length (mm)	Per pkg.	Part No.
3	90	33	1	B-57401
3.5	100	39	1	B-57417
4	105	43	1	B-57423
4.5	110	47	1	B-57439
5	116	52	1	B-57445
5.5	123	5	1	B-57451
6	123	57	1	B-57467
6.5	131	63	1	B-57473

SDS-PLUS Wood Drill bit



Size: mm

Bit diameter (mm)	Overall length (mm)	Working length (mm)	Per pkg.	Part No.
4	105	43	1	B-57489
5	116	52	1	B-57495
6	123	57	1	B-57504
8	147	75	1	B-57510
10	163	87	1	B-57526

Drill bit assortment with SDS-PLUS shank



5pc. assortment

Description	Part No.
for metal 3, 4mm	B-57532
for wood 4, 5, 6mm	

MAKPAC 65pcs. Set for SDS-PLUS

HSS-TiN drill bit for SDS-PLUS x8pcs. Wood drill bit for SDS-PLUS x5pcs, Masonry drill bit for SDS-PLUS x5pcs, Screw bit 25mm x40pcs, Nutsetter x4pcs. Countersink, Sleeve chuck bitholder for SDS-PLUS, Measure



metric size

Part No.

B-69478

SDS-PLUS Sleeve chuck bit holder



With magnet



Length (mm)	Shank Type	Part No.
80	SDS-PLUS	B-57548

Tools for Hex Shank Hammers



TCT drill bit for 17mm Hex Shank Hammers











Bit diameter (mm)	Overall length (mm)	Working length (mm)	Part No.
16	280	155	D-20127
16	505	365	D-20133
18	280	155	D-20149
18	505	365	D-20155
19	280	155	D-20161
19	505	365	D-20177
20	280	155	D-20183
20	505	365	D-20199
22	280	155	D-20208
22	505	365	D-20214
26	280	155	D-20220
26	505	365	D-20236
28	280	155	D-20242
28	505	365	D-20258
32	505	360	D-20270
35	505	360	D-20292

Drilling (Masonry)

Chisels



Shape	Application	For SDS-PLUS hammers	For SDS-MAX hammers	17mm Hex	19mm Hex	21mm Hex	28.6mm Hex	30mm Hex	Makita Small
Self sharpening bull point 	Demolition and adjustment work in masonry and concrete. Chipping and breaking in masonry and concrete. Starts holes in concrete No time consuming resharpening is needed.		●				●	●	
Bull point 	Demolition and adjustment work in masonry and concrete. Chipping and breaking in masonry and concrete. Starts holes in concrete	●	●	●	●	●	●	●	●
Cold chisel 	Adjustment work in masonry and concrete. Chipping, breaking, edging and channeling in masonry and concrete.	●	●	●	●	●	●	●	
Grooving chisel 	Cutting channels in concrete.	●		●		●			●
Scaling chisel 	Removing concrete residues.	●	●	●	●	●	●	●	●
Clay spade 	Digging in clay, hard gravel, hard packed gravel, soil and dirt.		●	●	●	●	●	●	
Rammer 	Tamping asphalt and compacting gravel, soil and dirt.		●	●	●	●	●	●	
Bushing tool 	Roughing concrete and asphalt up.		●	●		●			
Scraper 	Scraping floor tiles, linoleum floor and clean-up.	●							●

Drilling (Masonry)

Tools for SDS-PLUS Hammers



Premium Bull point for SDS-Plus Hammers



Length (mm)	Part No.
250	B-64238

Premium Cold chisel for SDS-Plus Hammers



Length (mm)	Part No.
250x20	B-64244

Premium Scaling chisel for SDS-Plus Hammers



Length (mm)	Part No.
250x40	B-64250

Bull point for SDS-PLUS Hammers

(For demolishing concrete)



Length (mm)	Part No.
160	D-08034
230	D-71249
250	D-08713

Cold chisel for SDS-PLUS Hammers

(For chipping, edging, channeling and breaking away larger chunks of concrete)



Length (mm)	Part No.
20 x 160	D-71255
20 x 230	D-71261
20 x 250	D-08729
20 x 400	D-19021

Scaling chisel for SDS-PLUS Hammers

(A wide chisel for chipping away scale of dried concrete spatter)



Length (mm)	Part No.
38 x 200	A-30483
40 x 230	D-71277
40 x 250	D-08735
50 x 215	D-25616

Scraper assembly for SDS-PLUS Hammers

(For removing linoleum tile and other flooring)



Length (mm)	Type	Part No.
100	-	A-68161
100	Cutter	343411-9

Chisel for SDS-PLUS Hammers 3pcs set



Description	Size (mm)	Each	Sum	Part No.
Bull point	230	1	3	D-71314
Cold chisel	20 x 230	1		
Scaling chisel	40 x 230	1		

Chisel for SDS-PLUS Hammers set (with aluminum case)



Description	Size (mm)	Each	Sum	Part No.
Bull point	250	1	3	D-05181
Cold chisel	20 x 250	1		
Scaling chisel	40 x 250	1		
Bull point	250	2	4	D-08757
Cold chisel	20 x 250	2		
Bull point	250	2	5	D-16368
Cold chisel	20 x 250	2		
Scaling chisel	40 x 250	1		

Drilling (Masonry)

Tools for SDS-MAX Hammers



Premium Bullpoint for SDS-MAX Hammers



Length (mm)	Part No.
400	B-64266

Premium Cold chisel for SDS-Max Hammers



Length (mm)	Part No.
400x25	B-64272

Premium Scaling chisel for SDS-Max Hammers



Length (mm)	Part No.
380x50	B-64288

Bull point for SDS-MAX Hammers

(For demolishing concrete)
*10pcs set



Length (mm)	Part No.	Length (mm)	Part No.
300	D-34176	400	D-34182
280	D-80787	400	D-80793

Self-Sharpening Bull point for SDS-MAX Hammers



Length (mm)	Part No.
400	B-10621



Cold chisel for SDS-MAX Hammers

(For chipping, edging, channeling and breaking away larger chunks of concrete)
*10pcs set



Size (mm)	Part No.	Size (mm)	Part No.
25 x 300	D-34207	25 x 400	D-80818
25 x 280	A-80802	24 x 600	A-87482
25 x 400	D-34213		

Scaling chisel for SDS-MAX Hammers

(A wide chisel for chipping away scale of dried concrete spatter)



Size (mm)	Part No.
50 x 400	A-80824
50 x 400	D-34235

Scaling chisel for Tile (for SDS-MAX Hammers)



Size (mm)	Part No.
50 x 300	A-80830

Bushing tool for SDS-MAX Hammers

(For concrete surface removal)

• Use with shank (A-19897)



Size (mm)	Part No.
67 x 67	A-19881

Drilling (Masonry)

Rammer for SDS-MAX Hammers

A: Dia.

(For tamping)

• Use with shank (A-19897)



Diameter (mm)	Part No.
140	A-19875

Concrete Core Cutter for SDS-MAX Hammers



Bit diameter (mm)	Overall length (mm)	Part No.
40	550	B-57629
45	550	B-57635
45	990	B-57641
55	550	B-57657
55	990	B-57663
65	550	B-57679
65	990	B-57685
80	550	B-57691
80	990	B-57700

Tools for 17mm Hex Shank Hammers



Bull point for 17mm Hex Shank Hammers

(For demolishing concrete)



Size (mm)	Part No.
280	D-08682
450	D-16863

Sharper Edge Bull Point (8 degrees edge) for 17mm Hex Shank Hammers



Length (mm)	Part No.	Length (mm)	Part No.
280	D-26303	350	D-29860

Cold chisel for 17mm Hex Shank Hammers

(For chipping, edging, channeling and breaking away larger chunks of concrete)



Size (mm)	Part No.
19 x 210	D-26587
19 x 280	D-08707
19 x 450	D-16879

Grooving chisel for 17mm Hex Shank Hammers

(For grooving, channeling or removal of heavy scale, especially in narrow or recessed areas.)



Length (mm)	Part No.	Length (mm)	Part No.
22 x 280	A-48555	26 x 280	A-48561

Scaling chisel for 17mm Hex Shank Hammers

(A wide chisel for chipping away scale of dried concrete spatter)



Size (mm)	Part No.
50 x 280	A-80606
50 x 280	D-20694

Scaling chisel for 17mm Hex Shank Hammers

(For concrete surface removal)



Length (mm)	Part No.
60 x 60	A-21484

Drilling (Masonry)

Chisel for 17mm Hex Shank (Hammer 3pcs set)



Description	Size (mm)	Each	Sum	Part No.
Bull point	255	1	3	D-71320
Cold chisel	20 x 255	1		
Scaling chisel	40 x 255	1		

Tools for 21mm Hex Shank Hammers



Bull point for 21mm Hex Shank Hammers

(For demolishing concrete)



Size (mm)	Part No.
320	D-16499
450	D-23824

Cold chisel for 21mm Hex Shank Hammers

(For chipping, edging, channeling and breaking away larger chunks of concrete)



Length (mm)	Part No.
26 x 320	D-17588
26 x 450	D-17594

Scaling chisel for 21mm Hex Shank Hammers

(A wide chisel for chipping away scale of dried concrete spatter)



Length (mm)	Part No.
70 x 320	A-20672

Tools for 28.6mm Hex Shank Hammers



With Brim



Without Brim

Self sharpening bull point for 28.6mm Hex Shank Hammers

(For demolishing concrete)



Length (mm)	Brim	Part No.
400	Without	B-10372

Bull point for 28.6mm Hex Shank Hammers

(For demolishing concrete)



Length (mm)	Brim	Part No.
410	Without	D-17631
350	Brim and Groove	D-65034

Cold chisel for 28.6mm Hex Shank Hammers

(For chipping, edging, channeling and breaking away larger chunks of concrete)



Size (mm)	Brim	Part No.
28 x 410	Without	D-17647

Drilling (Masonry)

Scaling chisel for 28.6mm Hex Shank Hammers

(A wide chisel for chipping away scale of dried concrete spatter)



Size (mm)	Brim	Part No.
75 x 410	With	D-29228

Tools for 30mm Hex Shank Hammers



Bull point for 30mm Hex Shank Hammers

(For demolishing concrete)



Length (mm)	Part No.
400	D-15285

Cold chisel for 30mm Hex Shank Hammers

(For chipping, edging, channeling and breaking away larger chunks of concrete)



Size (mm)	Part No.
30 x 400	A-15300

Scaling chisel for 30mm Hex Shank Hammers

(A wide chisel for chipping away scale of dried concrete spatter)



Size (mm)	Part No.
75 x 310	D-23868
100 x 310	A-25183

Tools for Makita Small Shank



Bull point for Makita Small Shank



Length (mm)	Part No.
220	B-06921

Scaling chisel for Makita Small Shank

(A wide chisel for chipping away scale of dried concrete spatter)



Size (mm)	Part No.
30 x 150	B-07331
50 x 150	B-07347

Scraper assembly for Makita Small Shank

(For removing linoleum tile and other flooring)



Size (mm)	Type	Part No.
100	-	A-68155
100	Cutter	343411-9

ACCESSORIES

Fastening



Hex (H)



PZ



Square (SQ)



Slotted (SL)



T



Phillips (PH)



TH



With magnet



Made of chrome-molybdenum alloy steel



Made of chrome-molybdenum alloy steel



For 3/8" square drive



For 1/2" square drive

Fastening

33.Thread rod socket bit

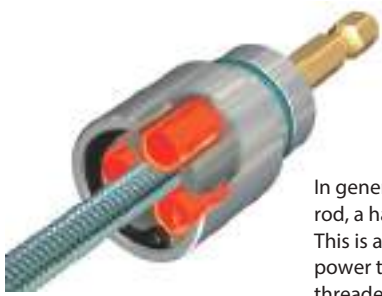

In general working with a threaded rod, a hand tool is used. This is a socket bit to use an electric power tool for working with a threaded rod efficiently.

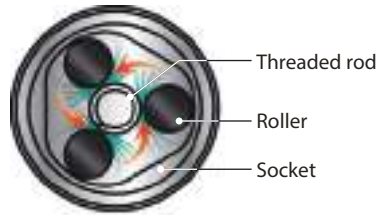

By adding rotating power on a socket bit, 3 cylindrical rollers hold threaded rod without damaging it.



34.Hollow socket

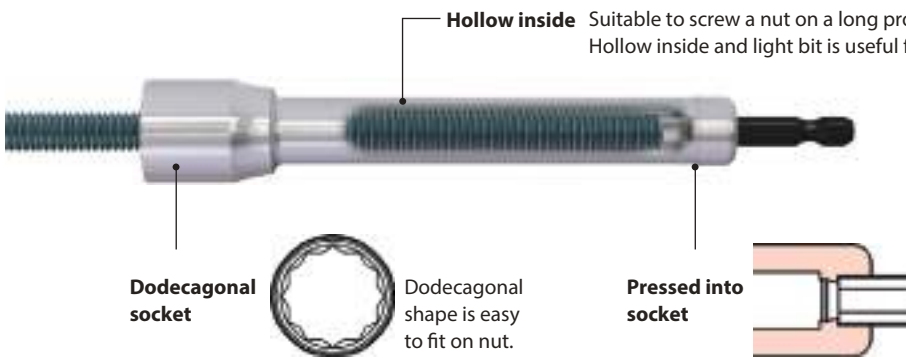

Hollow inside Suitable to screw a nut on a long protruded bolt. Hollow inside and light bit is useful for upward work.

Dodecagonal socket



Dodecagonal shape is easy to fit on nut.

Pressed into socket

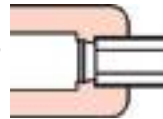

The bit part is pressed into socket part to be tough and durable.



Screwing nuts on bolt at high place



Bit Catcher







Easy attachable and detachable by one touch action. Easy bits replacing at high place.



Fastening

Screw bit

1/4" Hex Shank (C-form)		
A	C-form	





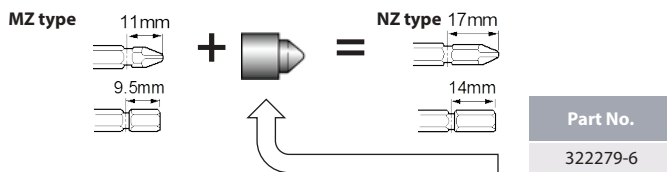

1/4" Hex Shank (E-form)		NZ	MZ
B	E-form (Single Ended)	 14mm	 9.5mm
C	E-form (Double Ended)	 17mm	 11mm

Bit piece for screwdriver & impact driver

You can change from MZ type bit to NZ type bit.



Drive type

Phillips (PH)	PZ	Hex (H)	T	TH	Square (SQ)	Slotted (SL)
						

Magnetic Bit Holder for screwdriver



1/4"Hex (MZ)

Length (mm)	Shank Type	Per pkg.	Part No.
60	MZ-B	1	784811-8
76	MZ-B	1	784801-1

Ultra mag torsion bit holder

1/4"Hex (MZ)



Length (mm)	Shank Type	Per pkg.	Part No.
79	MZ-B	1	B-28531

Flexible bit holder

Flexible extension for driving into hard to access corners.



Overall length (mm)	Part No.
300mm	B-29094

Flexible tough bit holder

It is able to use with Impact Driver.

Flexible extension for driving into hard to access corners.



Overall length (mm)	Shank type	Part No.
300mm	NZ-B	B-51851

Screw bit for screwdriver (E-form)



1/4"Hex (NZ)

Size	Length (mm)	Shank Type	Per pkg.	Model No.	Part No.	
+	PH 2	122	NZ-B	5	DFR440, 6845, 6841R	A-45858
	PH 2	132	NZ-B	5	6833 series, 6835D	A-16536
	PH 2	162	NZ-B	5	6842, 6843, DFR540, DFR550	B-10481
	PH 2	182	NZ-B	5	6844, DFR750	B-10475

10pcs. Double ended Screw bit set

Flexible extension for driving into hard to access corners.



1/4"Hex (NZ)

Size	Length (mm)	Shank Type	Per pkg.	Part No.	
+	PH 2	45	NZ-C	10	D-34827
	PH 2	65	NZ-C	10	D-33679
	PH 2	110	NZ-C	10	D-34833
	PH 2	65	Slim	10	B-90015

Double ended Screw bit

1/4"Hex (NZ)

Size	Length (mm)	Shank Type	Per pkg.	Part No.	
+	PH 2	45	NZ-C	3	798308-1
	PH 2	45	NZ-C,Hard	1	784229-3
	PH 2	65	NZ-C	1	784203-1
	PH 2	65	NZ-C,Hard	1	784230-8
	PH 2	110	NZ-C	1	784206-5
+	PH2 - SL0.8	45	NZ-C	1	784614-0

Fastening

Double ended twist torsion screw bit

20x
Life



With magnet

* Japanese Package
1/4"Hex (NZ)

	Size	Length (mm)	Shank Type	Per pkg.	Part No.
+	PH2	90	NZ-C	3	A-59570*
	PH2 (Slim)	90	NZ-C	3	A-59601*
	PH2	65	NZ	3	A-67505
	PH2(Slim)	65	NZ	3	A-67511

Double ended silver torsion screw bit

10x
Life



With magnet

1/4"Hex (MZ)

	Size	Length (mm)	Shank Type	Per pkg.	Part No.
+	PH 2	85	MZ-C	3	B-12326

* Japanese Package
1/4"Hex (NZ)

	Size	Length (mm)	Shank Type	Per pkg.	Part No.
+	PH 2	65	NZ-C	3	A-49563 *
	PH 2	65	NZ-C	6	A-49579 *
	PH 2	85	NZ-C	3	A-49585 *
	PH 2	110	NZ-C	3	A-49600 *
	PH 2	150	NZ-C	3	A-50120 *
	PH 2	110	NZ-C	10	B-52037

Magnet nutsetter



With magnet



1/4"Hex (MZ or NZ)

Size	A	Length (mm)	Shank Type	Per pkg.	Part No.
M5	8mm	50	MZ or NZ-B	1	B-38934
M5	8mm	50	NZ	50	B-68345

Magnet nutsetter 5pcs. Assortment



With magnet



1/4"Hex (MZ or NZ)

A (mm)	Length (mm)	Shank Type	Per pkg.	Part No.
6,8,10,12,13	50	MZ or NZ-B	1pc each	B-39176

Magnet nutsetter 4pcs. assortment (C-form)



With magnet



A (mm)	Length (mm)	Shank Type	Per pkg.	Part No.
8,10,12,13	48	A	1pc each	B-57554

12pcs. Screw Bit Set with magnetic bit holder

1/4"Hex (NZ)

- + PH1,PH2,PH3 x 25mm
- + PZ1,PZ2,PZ3 x 25mm
- T10, T15, T20, T25, T30 x 25mm Magnetic Bit Holder NZ



Part No.

D-31011

31pcs. Screw bit set / Clamshell

- + PH0, PH1, 4xPH2, PH3 x 25mm, + PZ0, PZ1, 4xPZ2, PZ3 x 25mm
- SL4.5, SL5.5, SL6.5 x 25mm, ○ T10, T15, 2xT20, 2xT25, T27, T30, T40 x 25mm,
- H3, H4, H5, H6 x 25mm, Skeeve chuck bit holder



Shank Type	Part No.
NZ	B-69901

Battery type case / Shrink rap

*with 21pcs. inner module



Part No.

B-69917

*E-00315

Fastening

31pcs. Screw Bit Set easy removable bit holder case

- PH1, 2xPH2, PH3 x 25mm
- PZ1, 2xPZ2, PZ3 x 25mm
- 3xT10, 3xT15, 4xT20, 4xT25, 3xT30, 2xT40 x 25mm,
- H4, H5, H6 x 25mm, Magnetic Bit Holder MZ



Part No.
D-34936

Ring Nut Setter

The spring-loaded clip retains the fastener, eliminating all build up of swarf on the magnet which prevents correct fastener connection.



Size	Length (mm)	Shank Type	Per pkg.	Part No.
8mm(5/16")	50	NZ-B	1	B-30455

21pcs. Screw Bit & Socket Set with Ratchet Handle

- PH1, PH2, PH3 x 25mm
- PZ1, PZ2 x 25mm
- SL0.8x5.5, SL1.2x6.5 x 25mm
- T20, T25, T30 x 25mm
- H4, H6 x 25mm

Socket, H5, H6, H8, H10, H12, H13
Magnetic Bit Holder MZ
Ratchet Handle 1/4"



Part No.
B-54081

11pcs. Torsion screw bit set

1/4"Hex (MZ)

- PH1, PH2, PH3 x 25mm
- PZ1, PZ2, PZ3 x 25mm
- T15, T20, T25, T30 x 25mm

Torsion Bit Holder

Impact GOLD



Part No.
B-28597

- PH1, PH2, PH3 x 25mm
- PZ1, PZ2, PZ3 x 25mm,
- T15, T20, T25, T30 x 25mm

Ultra Mag Torsion Bit Holder

Part No.
B-30754



43pcs. Color screw bit set / Clamshell

- PH1, 2xPH2, PH3 x 25mm,
- PZ1, 2xPZ2, PZ3 x 25mm
- SL3.0, SL4.0, SL4.5, SL5.5 x 25mm,
- T10, 2xT15, 2xT20, T25, T27, T30, T40 x 25mm
- T10H, T15H, T20H, T25H, T27H, T30H, T40H x 25mm,
- H3, H4, H5, H6
- PH2 x 75mm,
- PZ2 x 75mm,
- SL4.5 x 75mm

Magnetic nutsetter 6,8,10mm
Sleeve chuck bit holder 60mm
Screw guide bit holder 80mm

Shank Type	Part No.
MZ / NZ	B-55697



Socket Adapter set.



It allows impact driver to fasten or loosen bolt and nut.
8,10,12,13,14,15,17,18mm
Socket adapter 50mm



1/4"Hex (NZ)

Size	Shank Type	Per pkg.	Part No.
SQ 1/2"	NZ-B	1	B-55762

Tilt Socket Adapter

The socket can tilt up to 15° angle to assist fastening in confined applications.

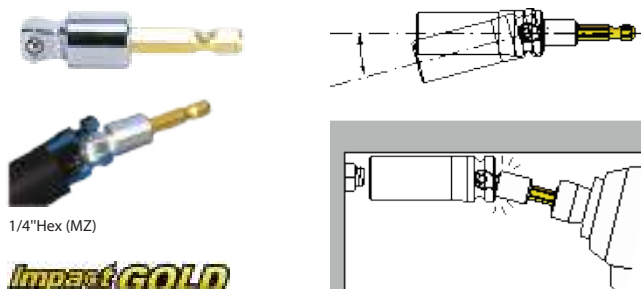

1/4"Hex (MZ)

Impact GOLD

1/4"Hex (MZ)

Size	Length (mm)	Shank Type	Per pkg.	Part No.
SQ 3/8"	56	MZ-B	1	B-28547
SQ 1/2"	56	MZ-B	1	B-28553

Fastening

Mini Candy Jar case Screw bit Set



Size	Type	Per pkg.	Part No.
Ph 2-50mm	E-form (NZ)	50	B-25177
Ph 2-25mm	C-form	100	B-24876

Screw bit set in Blister package



Size	Type	Per pkg.	Part No.
Ph 1-50mm	E-form (NZ)	3	B-25030
Ph 2-50mm	E-form (NZ)	3	B-25046

"MZ and NZ shank tube" is a Makita word. It is NOT a general term.

Flip Top case Screw bit Set



Size	Type	Per pkg.	Part No.
Ph 1-50mm	E-form (NZ)	10	B-25111
Ph 2-50mm	E-form (NZ)	10	B-25127
Ph 3-50mm	E-form (NZ)	10	B-25133
Ph 1-25mm	C-form	25	B-24577
Ph 2-25mm	C-form	25	B-24583
Ph 3-25mm	C-form	25	B-24599

"MZ and NZ shank tube" is a Makita word. It is NOT a general term.

Screw bit set in the Bag



With magnet



B-24985



B-25199

Size	Type	Per pkg.	Part No.
Ph 2-50mm	E-form (NZ)	50	B-25199
Ph 2-25mm	C-form	100	B-24985

"MZ and NZ shank tube" is a Makita word. It is NOT a general term.

Bit adapter / Clamshell



1/4"Hex (MZ)

Drive size	Bit size	Part No.	Pin	O-ring
			Part No.	Part No.
1/4"Hex (NZ)				

1/4"Hex (NZ)

SQ3/8"	1/4"Hex(NZ)	B-68482	-	-
SQ1/2"	1/4"Hex(NZ)	B-68476	B-54586	B-54558

Impact Socket

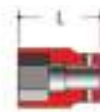
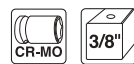

For Impact Wrenches with 3/8" square drive.

A(mm)	L(mm)	Part No.	A(mm)	L(mm)	Part No.
6	28	B-39883	15	28	B-39970
7	28	B-39899	16	28	B-39986
8	28	B-39908	17	30	B-39992
9	28	B-39914	18	30	B-40004
10	28	B-39920	19	30	B-40010
11	28	B-39936	20	30	B-40026
12	28	B-39942	21	30	B-40032
13	28	B-39958	22	30	B-40048
14	28	B-39964			

Fastening

9pcs. Impact socket set / Clamshell



(With pin and O ring)
10,11,13,17,19,21,22, 24, 27 mm



Part No.
B-69749

8pcs. Impact socket (Deep type) set / Paper sleeve



*With pin and O ring



Drive	Size	Part No.
1/2" Drive	8,10,12,13,14,17,19,21 mm	E-02989

Roll Up Pouch



Part No.
E-02995

Impact Socket (Bulk)



*3pcs / set
For Impact Wrenches with 1/2" square drive.

A(mm)	L(mm)	Impact Socket	Pin	O-ring
		Part No.	Part No.	Part No.
10	38	B-10497	268056-1	213396-2
12	38	A-89931	268056-1	213396-2
13	38	134825-1	268056-1	213396-2
14	38	134826-9	268056-1	213396-2
16	38	B-10506	268056-1	213396-2
17	38	134829-3	268056-1	213397-0
19	38	134831-6	268057-9	213398-8
21	38	134838-2	268057-9	213399-6
22	38	134851-0	268057-9	213399-6
23	38	134840-5	268057-9	213399-6
24	45	134841-3	268057-9	213399-6
26	50	134842-1	268057-9	213399-6
27	50	134844-7	268057-9	213399-6
30	50	134846-3	268057-9	213399-6
32	50	134848-9	268057-9	213399-6
13	52	134827-7	268056-1	213397-0
14	52	134828-5	268056-1	213397-0
17	52	134830-8	268056-1	213397-0
19	52	134832-4	268057-9	213398-8
21	52	134833-2	268057-9	213398-8
22	52	134834-0	268057-9	213398-8
23	52	134835-8	268057-9	213398-8
24	52	134836-6	268057-9	213398-8

Deep type

12	75	134867-5	256095-3	213370-0
19	78	134837-4	268057-9	213399-6
21	78	134839-0	268057-9	213399-6
26	78	134843-9	268057-9	213399-6
27	78	134845-5	268057-9	213399-6
30	78	134847-1	268057-9	213399-6
32	78	134849-7	268057-9	213399-6

For Impact Wrenches with 19mm (3/4") square drive



A(mm)	L(mm)	Impact Socket	Pin	O-ring
		Part No.	Part No.	Part No.
26	52	134853-6	213461-7	256283-2
32	52	134871-4	213514-2	256282-4

Impact Deep Socket (Bulk)



A(mm)	L(mm)	Impact Socket	Pin	O-ring
		Part No.	Part No.	Part No.
12	75	134867-5	256095-3	213370-0
19	78	134837-4	268057-9	213399-6
21	78	134839-0	268057-9	213399-6
26	78	134843-9	268057-9	213399-6
27	78	134845-5	268057-9	213399-6
30	78	134847-1	268057-9	213399-6
32	78	134849-7	268057-9	213399-6

Socket Extension



1/2" anvil

A(mm)	Length (mm)	anvil	Impact Socket	Pin	O-ring
			Part No.	Part No.	Part No.
SQ1/2"	75	SQ1/2"	B-55706	B-54586	B-54542
SQ 1/2"	150	SQ 1/2"	B-55712	B-54586	B-54542
SQ1/2"	300	SQ1/2"	B-55728	B-54586	B-54542

Fastening

Threaded rod socket bit

By rotating the threaded rod inserted into the socket bit, the pins inside of the socket move towards the center of the socket along to the inner surface of the socket and grip the threaded rod tightly. With that state, able to screw the threaded rod by rotating the socket bit.



1/4"Hex (MZ)

Size	Length (mm)	Shank Type	Per pkg.	Part No.
M6	66	MZ-B	1	B-42961
M8	66	MZ-B	1	B-42977
M10	66	MZ-B	1	B-42983
3/8"	66	MZ-B	1	B-51611
1/2"	66	MZ-B	1	B-51627

Bit Catcher

Part No.	Type
B-63096	Blue
B-63105	Black



Key Adapter

Part No.
B-63111



Hollow socket bit

Able to screw nut to the middle of the threaded rod. Hollow inside makes the bit lighter.

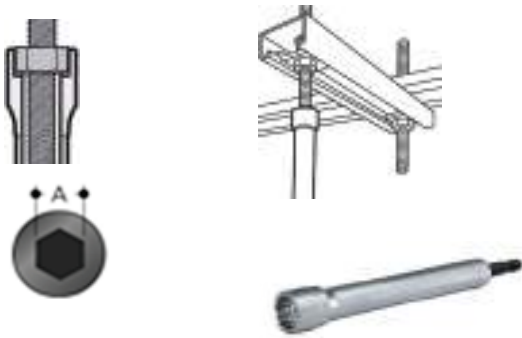

1/4"Hex (MZ)

A (mm)	Length	Shank Type	Per pkg.	Part No.
10mm	75mm	MZ-B	1	B-52526
10mm	150mm	MZ-B	1	B-52532
10mm	300mm	MZ-B	1	B-52548
10mm	500mm	MZ-B	1	B-52554
10mm	700mm	MZ-B	1	B-52560
13mm	75mm	MZ-B	1	B-52576
13mm	150mm	MZ-B	1	B-52582
13mm	300mm	MZ-B	1	B-52598
13mm	500mm	MZ-B	1	B-52607
13mm	700mm	MZ-B	1	B-52613
17mm	75mm	MZ-B	1	B-52629
17mm	150mm	MZ-B	1	B-52635
17mm	300mm	MZ-B	1	B-52641
17mm	500mm	MZ-B	1	B-52657
17mm	700mm	MZ-B	1	B-52663

ACCESSORIES

▣ Drill and Screw Bit Sets



Drill and Screw Bit Sets

71pc. bit & hand tool set (6pc. set)

Masonry Drill Bit x6pcs. Wood Drill Bit x5pcs, Flat Bit x3pcs. HSS-R Drill Bit x11pcs. Measure 3m, Diameter gauge 1-10mm, countersink, Screw bit 50mm x10pcs. Socket x7pcs. Screw bit 25mm x24pcs. Magnetic Bit Holder, Socket Adapter for 25mm screw driver



metric size Type NZ (Bulk, without counter display)
Part No.
D-53001

103pc. Bit & Hand Tool Display Set (5pc. set)

Masonry Drill x7pcs. Wood Drill x7pcs. Flat Bit x3pcs. HSS-R Drill Bit x11pcs, Hole saw, Hole saw arbor, Depth stop, Measure 3m, Diameter gauge 1-10mm, Hex key wrench, Level, Countersink, Screw bit 25mm x24pcs, Magnetic Bit Holder, Socket x7pcs. Socket Adapter for 25mm screw driver, Long nose plier, Combination plier, Adjustable wrench, Nail hammer



metric size Type NZ (Bulk, without counter display)
Part No.
D-53017

30pc. combination set

HSS-R Drill Bit x4pcs. Masonry Drill Bit x4pcs. Wood Drill Bit x4pcs. Screw bit 25mm x16pcs. Magnetic Bit Holder, Countersink



metric size Type NZ (Bulk, without counter display)
Part No.
D-53702

Drill bit assortment with 1/4" Hex. shank

1/4"Hex (MZ)

for metal 5, 6, 8mm, for wood 5, 6mm

metric size Type MZ
Part No.
D-31516

for masonry 6mm, for wood 5, 6mm, for metal 5, 6mm

metric size Type MZ
Part No.
D-31522



Drill bit assortment

9 pc assortment
5, 6 and 8 mm of 3 different types.
HSS-TiN drill bit (for metal)
Carbide tipped drill bit (for masonry)
Wood drill bit (for wood)

Part No.
D-08660



Drill bit assortment

9pc. assortment

HSS-TiN drill bit, Carbide tipped drill bit, Wood drill bit

metric size
Part No.
D-30069



HSS metal drill 5pc. drill bit assortment

for metal 5/ 6/ 8mm, for wood 6/ 8mm



metric size, Type MZ
Part No.
D-30106



17pc. combination set

HSS-R Drill Bit x4pcs. Masonry Drill Bit x 4pcs. Screw bit 25mm x12pcs. Magnetic Bit Holder



metric size Type NZ
Part No.
D-53693

ACCESSORIES

▣ Cutting



Dia / Bore



No. Teeth



Kerf



Thickness



Rake



Ring



Rip cut



Cross cut



Tip embedded



Silent



M-Force



Fast cut



Clean cut



Extra clean cut



Coated



Heavy duty



Long life



PCD tip















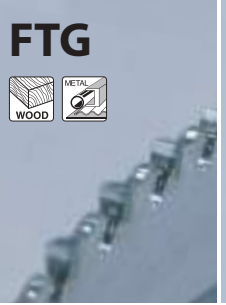

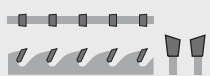
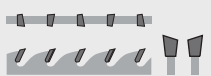

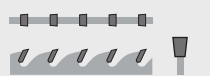



Sharp

Cutting



Carbide-tipped saw blade

Tooth shape

 <p>ATB</p> <p>WOOD METAL</p>	 <p>ATAF</p> <p>WOOD</p>	 <p>ATAFR</p> <p>WOOD</p>	 <p>M-FORCE</p> <p>WOOD</p>	 <p>FTG</p> <p>WOOD METAL</p>	 <p>TCG</p> <p>METAL ALU</p>
<p>Alternate top bevel For wood and aluminum. ATBR: Added flat teeth to ATB for easy straight cutting</p> 	<p>Alternate top alternate face Enables to cut wood fiber sharply.</p> 	<p>Added flat teeth to ATAF for easy straight cutting. MATAFR: Modified ATAFR for less cutting resistance.</p> 	<p>Tooth front and top shapes symmetric V groove having features of ATB and FTG.</p> 	<p>Flat teeth, allows easy straight cutting and tips are rarely chipped. For cutting wood along the grain and cutting thin metal.</p> 	<p>Trapezoidal and flat teeth are arranged alternately and they divide debris by three. Allows easy straight cutting and tips are rarely chipped.</p> 

 <p>MTCG</p> <p>METAL</p>	 <p>SMTCG</p> <p>METAL ALU</p>	 <p>Hi-ATB</p> <p>WOOD</p>	 <p>EFFICUT</p> <p>WOOD</p>	 <p>EFFICUT Metal</p> <p>METAL</p>
<p>Flat teeth with alternating bevel Less cutting resistance than flat teeth. Tips are rarely chipped</p> 	<p>Contrast to MTCG, asymmetric two bevels on a tooth top producing sharp edges Allows easy bite to materials.</p> 	<p>Alternate top bevel (ATB) with a larger top bevel angle</p> 	<p>Special tooth design increased work amount per 1 battery charge</p> 	

Technical term

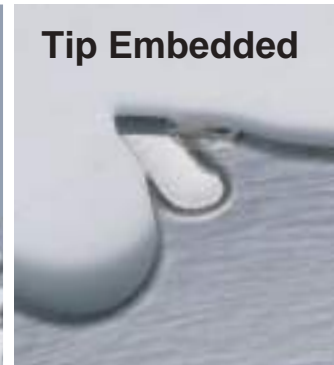
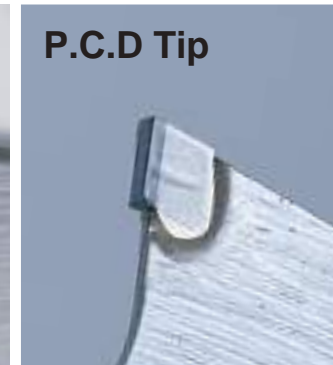
 <p>Laser Slit</p>	 <p>Coated</p> <p>SPECIALIZED DIAMOND CUTTING</p>	 <p>Tip Embedded</p>	 <p>P.C.D Tip</p>
<p>Vibration dampening system Resinbond filled laser cut body slots for smoother and quieter cuts.</p>	<p>PTFE (polytetrafluoroethylene) coating plate to reduce pitch build-up and to lower resistance.</p>	<p>Inserted tooth design will greatly increase the body-to-tip braze area for greater support and tip strength.</p>	<p>PCD (Poly-Crystalline Diamond) tips has extreme hardness and wear resistance. PCD tipped saw blade is the best choice for long lasting performance when cutting fiber cement board.</p>

IDEAL FOR CORDLESS CIRCULAR SAWS

EFFICUT



VIDEO CLIP

This movie was filmed in Japan. Models and specs may vary by country.

Feature of EFFICUTs

	<p>EFFICIENT Sharp top angle</p>		<p>Enable you to make a fine cut surface with only little effort.</p>
	<p>EFFICIENT Curved body</p>		<p>Allows the excellent chip chute performance.</p>
	<p>EFFICIENT Slimmed bottom</p>		<p>Realizes long life battery by saving cutting resistance.</p>

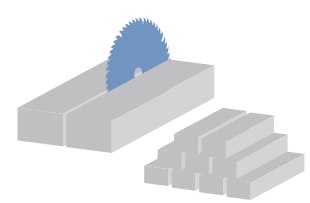

More cuts per charge



Fast cutting



Longer life

Plate: 1.6mm The amount of cutting per 1 charge

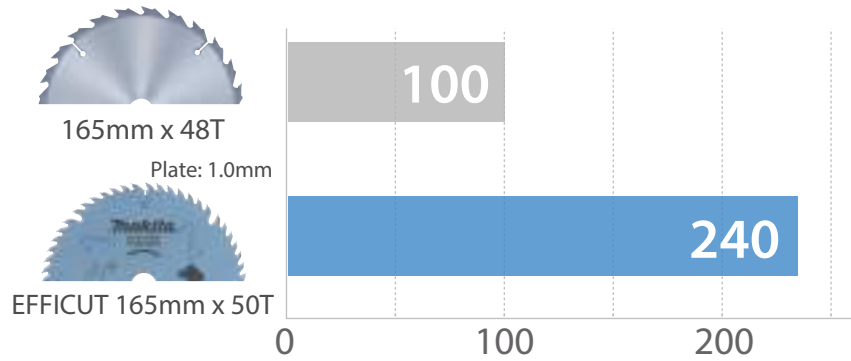

× 2.4 more



1. The test results depend to a great extent on the hardness of wood materials, etc.
 2. The cutting amount bar graphs are relative values when the capacity of current blade (Thickness : 1.6 mm) is indexed at 100.

Cutting

General Package

*These items are available on request. Contact us for the minimum order quantity.

Standard Blade

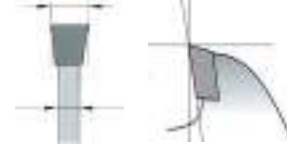

General Package

Outer diameter (mm)	Bore (mm)	Ring (mm)	Kerf (mm)	Plate (mm)	No. of teeth	Rake	Tooth shape	Material	Note	Per pkg.	Part No.
85	15		1	0.7	20	10	ATB	Wood		1	B-14607
136	20		1.5	1.0	16	20	ATB	Wood		1	B-09949
165	20		1.5	1.0	24	20	ATAF	Wood		1	A-85101
165	20		1.6	1.0	40	18	ATAF	Wood		1	A-85226
165	20		1.6	1.0	52	20	ATAF	Wood		1	A-85189



(Cordless Saw)

Ideal for Cordless Circular Saw



Outer diameter (mm)	Bore (mm)	Ring (mm)	Kerf (mm)	Plate (mm)	No. of teeth	Rake	Tooth shape	Material	Note	Per pkg.	Part No.
165	20		1.45	1.0	56	23	ATAFR	Wood/MDF	 Specialized for cordless saws	1	B-57364
165	20		1.4	1.0	25	23	ATAFR	Wood	-	1	B-63018
165	20		1.4	1.0	60	23	ATAFR	Wood	-	1	B-69892
185	20		1.45	1.0	24	23	ATAFR	Wood	-	1	B-62022
185	20		1.45	1.0	45	23	ATAFR	Wood	-	1	B-68616
190	20		1.45	1.0	24	23	ATAFR	Wood	-	1	B-64200
190	20		1.45	1.0	45	23	ATAFR	Wood	-	1	B-68644
235	25		2.15	1.65	24	10	ATAFR	Wood	-	1	E-01959
260	25.4		2.15	1.65	45	10	ATAFR	Wood	-	1	B-64668
260	25.4		2.15	1.65	60	10	ATAFR	Wood	-	1	B-67430
260	25.4		2.15	1.65	80	10	ATAFR	Wood	-	1	B-67446
305	25.4		2.15	1.65	60	10	ATAFR	Wood	-	1	B-67452
305	25.4		2.15	1.65	80	10	ATAFR	Wood	-	1	B-67468
305	25.4		2.15	1.65	100	10	ATAFR	Wood	-	1	B-67474



Double cut tooth



Outer diameter (mm)	Bore (mm)	Ring (mm)	Kerf (mm)	Plate (mm)	No. of teeth	Rake	Tooth shape	Material	Note	Per pkg.	Part No.
165	20		1.45	1.0	44	23	MATAFR	MDF / Wood	Coated / Laser Slit	1	B-53279
165	20		1.45	1.0	44	23	MATAFR	Wood		1	B-53285

Cutting

Ideal for Cordless Plunge Saw

Outer diameter (mm)	Bore (mm)	Ring (mm)	Kerf (mm)	Plate (mm)	No. of teeth	Rake	Tooth shape	Material	Note	Per pkg.	Part No.
165	20		1.45	1	56	23	ATAFR	Wood/MDF	 Specialized for cordless saws	1	B-57364
165	20		1.6	1.1	55	20	ATAFR	Wood/MDF	Specialized for cordless saws	1	B-57059

Ideal for Cordless Slide Compound Saw

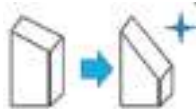

Extra sharp tooth



Outer diameter (mm)	Bore (mm)	Ring (mm)	Kerf (mm)	Plate (mm)	No. of teeth	Rake	Tooth shape	Material	Note	Per pkg.	Part No.
190	20		1.7	1.3	60	20	ATBR (4+1) Extra sharp tooth	MDF / Wood	Coated / Laser Slit Europe design	1	B-53291



Outer diameter (mm)	Bore (mm)	Ring (mm)	Kerf (mm)	Plate (mm)	No. of teeth	Rake	Tooth shape	Material	Note	Per pkg.	Part No.
165	20		1.9	1.4	64	10	ATAF	Wood	Laser Slit	1	B-56487
165	20		1.8	1.2	60	5	TCG	Aluminum	Laser Slit	1	B-56530



(Circular Saw)

Outer diameter (mm)	Bore (mm)	Ring (mm)	Kerf (mm)	Plate (mm)	No. of teeth	Rake	Tooth shape	Material	Note	Per pkg.	Part No.
160	20		2.2	1.4	24	25	ATB	Wood		1	A-81371
160	20		1.6	1	40	18	ATAF	Wood		1	A-80612
160	20		1.8	1.2	40	20	ATAF	Wood		1	B-16994
160	20		2.2	1.4	40	20	ATAF	Wood		1	A-81898
165	20		2	1.4	10	20	FTG	Wood		1	B-02917
165	20		2	1.3	16	23	ATB	Wood		1	A-86022
165	20		2	1.3	24	23	ATB	Wood		1	A-86038
165	20		2	1.3	40	18	ATB	Wood		1	A-86044
165	20		1.75	1.4	42	0	SMTCG	Sandwich Panel		1	B-63161
180	20		2.2	1.4	24	25	ATB	Wood		1	A-81402
180	20		2.2	1.4	40	20	ATAF	Wood		1	A-81418
185	20		1.85	1.3	20	25	ATB	Wood		1	A-83814
185	20		1.6	1	40	18	ATAF	Wood		1	A-82476
185	20		2	1.4	40	18	ATAF	Wood		1	A-85999
185	20		1.6	1	60	18	ATAF	Wood		1	A-82482
190	20		2	1.4	24	20	ATAF	Wood		1	A-87507
235	25		2.3	1.6	20	20	ATB	Wood		1	A-89947
235	25.4		2.6	1.8	60	20	ATAF	Wood		1	A-81474
260	25.4		2.3	1.6	24	20	ATB	Wood		1	B-10584
335	25		3	2.2	60	20	ATB	Wood		1	B-12603

Cutting

(Circular Saw Economy)

Outer diameter (mm)	Bore (mm)	Ring (mm)	Kerf (mm)	Plate (mm)	No. of teeth	Rake	Tooth shape	Material	Note	Per pkg.	Part No.
110	20		1.7	1.1	24	10	ATB	Wood		1	*D-15578
165	20		2	1.3	40	18	ATB	Wood		1	*D-03349
165	20		2	1.2	40	12	ATB	Wood		1	D-50500
185	20		1.8	1.2	24	20	ATB	Wood		1	*D-19037
185	25.4	20	2.2	1.4	24	15	ATB	Wood		1	D-50522
185	20		2	1.3	40	18	ATB	Wood		1	*D-03361
185	25.4	20	2.2	1.4	40	14	ATB	Wood		1	D-50538
210	25		2	1.3	24	20	ATB	Wood		1	*D-29066
235	25.4	25	2.4	1.6	40	18	ATB	Wood		1	*D-03377
235	25.4	25	2.5	1.6	40	12	ATB	Wood		1	D-50550

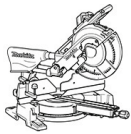

(Slide Compound Saw / Miter Saw)

Outer diameter (mm)	Bore (mm)	Ring (mm)	Kerf (mm)	Plate (mm)	No. of teeth	Rake	Tooth shape	Material	Note	Per pkg.	Part No.
190	20		2.2	1.6	24	5	ATB	Wood		1	B-03850
190	20		2	1.4	24	-5	ATB	Wood		1	B-03866
190	20		2	1.4	40	10	ATAF	Wood		1	A-86751
190	20		2	1.4	60	-5	ATB	Wood		1	B-03981
190	20		2	1.4	60	5	ATB	Wood		1	B-04008
190	20		2	1.4	72	10	ATAF	Wood		1	A-86359
255	25.4		2.3	1.8	32	5	ATAF	Wood		1	A-83696
255	25.4		2.2	1.7	40	10	ATAF	Wood		1	B-10322
255	25.4		2.3	1.8	80	5	ATAF	Wood		1	B-03648
255	25.4		2.2	1.7	40	10	ATAF	Wood		1	B-03654
255	25.4	25	2.6	2	100	15	ATAF	Wood		1	A-82292
260	25		2.3	1.8	64	5	ATAF	Wood		1	792695-0
260	25.4		2.6	1.8	100	12	ATB	Wood		1	D-65442
305	25.4		2.5	1.9	70	0	ATAF	Wood		1	B-57560
305	25.4		2.6	2	60	10	ATAF	Wood		1	A-85472
305	25.4		2.3	1.8	60	5	ATAF	Wood		1	B-02808
305	25.4		2.3	1.8	96	5	ATAF	Wood		1	B-02814
305	25.4		2.3	1.8	100	5	ATB	Wood		1	B-03698
305	25.4	25	3	2.2	100	15	ATAF	Wood		1	A-82323
305	30	25.4	2.3	1.8	40	5	ATB	Wood	BlueMak	1	B-54237
355	25		3	2.2	60	20	ATB	Wood		1	A-02618
355	25.4		2.6	2	60	10	ATB	Wood		1	A-85488
355	25.4	25	3.4	2.4	100	15	ATAF	Wood		1	A-82351



(Table Saw)

Outer diameter (mm)	Bore (mm)	Ring (mm)	Kerf (mm)	Plate (mm)	No. of teeth	Rake	Tooth shape	Material	Note	Per pkg.	Part No.
203	25.4	25	2.4	1.6	40	20	ATAF	Wood		1	A-81430
255	25.4		2.3	1.6	24	20	ATB	Wood		1	B-05000
255	25.4	25	3.2	2.2	30	25	ATB	Wood		1	A-82030
255	25.4		2.3	1.6	40	20	ATB	Wood		1	B-05088
255	25.4	25	2.8	2	60	20	ATAF	Wood		1	A-81505
305	25.4	25	3	2	60	20	ATAF	Wood		1	A-82105
355	25.4	25	3.4	2.4	80	20	ATAF	Wood		1	A-81533
405	25.4	25	3.6	2.6	80	20	ATAF	Wood		1	A-81561

Cutting

(Table Saw Economy)

Outer diameter (mm)	Bore (mm)	Ring (mm)	Kerf (mm)	Plate (mm)	No. of teeth	Rake	Tooth shape	Material	Note	Per pkg.	Part No.
203	25.4	25	2	1.4	24	25	ATB	Wood		1	B-17099
203	25.4	25	2	1.4	40	20	ATAF	Wood		1	B-17120
203	25.4	25	2	1.4	60	15	ATAF	Wood		1	B-17142
203	25.4	25	2	1.4	80	15	ATAF	Wood		1	B-17158
255	25.4	25	2.4	1.8	80	15	ATAF	Wood		1	B-17295
355	25.4	25	3	2.2	80	20	ATAF	Wood		1	B-17463

Specialized plunge cutting



(Plunge Cut Circular Saw)

Outer diameter (mm)	Bore (mm)	Ring (mm)	Kerf (mm)	Plate (mm)	No. of teeth	Rake	Tooth shape	Material	Note	Per pkg.	Part No.
165	20		2.2	1.6	28	15	ATB	Wood		1	B-07434
165	20		2.2	1.6	48	8	ATB	Wood		1	B-07353
165	20		2.4	1.7	48	5	TCG	CORIAN®		1	B-10344
165	20		2.4	1.7	56	-3	TCG	Aluminum		1	B-07440

Specialized MDF cutting



(Circular Saw)

Outer diameter (mm)	Bore (mm)	Ring (mm)	Kerf (mm)	Plate (mm)	No. of teeth	Rake	Tooth shape	Material	Note	Per pkg.	Part No.
165	20	15.88	2.2	1.4	52	-5	TCG	MDF		1	D-62474



(Slide Compound Saw / Miter Saw)

Outer diameter (mm)	Bore (mm)	Ring (mm)	Kerf (mm)	Plate (mm)	No. of teeth	Rake	Tooth shape	Material	Note	Per pkg.	Part No.
255	25.4		2.8	1.8	84	-10	TCG	MDF		1	D-62480
305	25.4		3.0	2.0	96	10	TCG	MDF		1	D-62496

Specialized multi-purpose cutting (Wood, MDF, Aluminium, PVC)

Outer diameter (mm)	Bore (mm)	Ring (mm)	Kerf (mm)	Plate (mm)	No. of teeth	Rake	Tooth shape	Material	Note	Per pkg.	Part No.
165	30	15.88/16/19/20	2.2	1.4	60	5	TCG	Wood,MDF,Aluminium,PVC		1	D-63616
185	30	15.88/16/20	2.2	1.4	60	5	TCG	Wood,MDF,Aluminium,PVC		1	D-63622
235	30	16/20/25/25.4	2.4	1.6	60	5	TCG	Wood,MDF,Aluminium,PVC		1	D-63557
260	30	16/20/25/25.4	2.6	1.8	120	5	TCG	Wood/MDF/Aluminium/PVC		1	D-62240
305	30	16/20/25/25.4	2.8	2.0	120	5	TCG	Wood/MDF/Aluminium/PVC		1	D-63591
355	30	16/20/25/25.4	3.0	2.2	100	5	TCG	Wood/MDF/Aluminium/PVC		1	D-63884

EFFICUT Metal



This movie was filmed in Japan.
Models and specs may vary by country.

Feature of EFFICUTs

EFFICIENT
Strong and least chipping

EFFICIENT
Release swarf smoothly

EFFICIENT
Release swarf smoothly

More cuts per charge

Fast cutting

Longer life

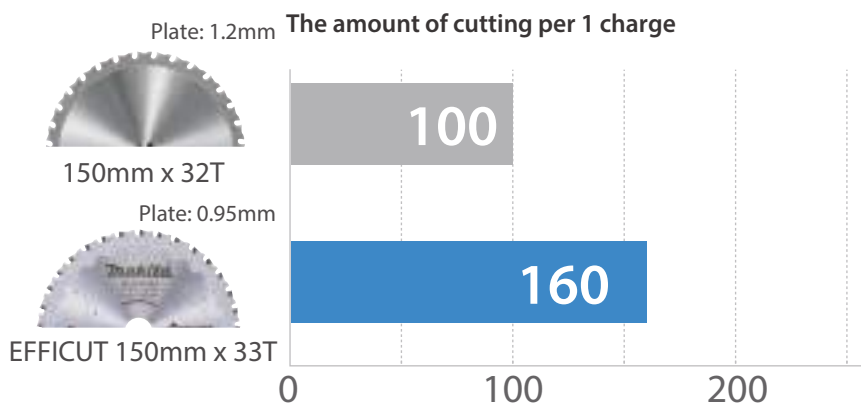

**x1.6
more**



Model: DCS553 (BL1860B)
Material: Carbon steel pipe (Dia: 31mm / Thickness: 3mm)



Cutting

Specialized aluminum cutting

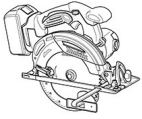

(Cordless Saw)

Outer diameter (mm)	Bore (mm)	Ring (mm)	Kerf (mm)	Plate (mm)	No. of teeth	Rake	Tooth shape	Material	Note	Per pkg.	Part No.
136	20		1.6	1	50	0	ATB	Aluminum		1	B-40331
150	20		1.6	1	52	0	ATB	Aluminum		1	B-47020



(Slide Compound Saw / Miter Saw)

Outer diameter (mm)	Bore (mm)	Ring (mm)	Kerf (mm)	Plate (mm)	No. of teeth	Rake	Tooth Shape	Material	Note	Per pkg.	Part No.
190	20		2	1.4	60	-5	TCG	Aluminum		1	B-03997
255	25.4		2.6	2	100	0	ATB	Aluminum		1	A-81614
355	25		3	2.2	80	5	TCG	Aluminum		1	A-02602

(Slide Compound Saw / Miter Saw Economy)

Outer diameter (mm)	Bore (mm)	Ring (mm)	Kerf (mm)	Plate (mm)	No. of teeth	Rake	Tooth Shape	Material	Note	Per pkg.	Part No.
260	25.4		3	2	100	5	TCG	Aluminum		1	*D-03414
305	30	15.88	3	2.2	80	5	TCG	Aluminum		1	*D-16520
355	30	25	3.3	2.35	120	8	TCG	Aluminum		1	*D-16592



(Table Saw)

Outer diameter (mm)	Bore (mm)	Ring (mm)	Kerf (mm)	Plate (mm)	No. of teeth	Rake	Tooth Shape	Material	Note	Per pkg.	Part No.
305	25.4	25	2.8	2.2	100	0	ATB	Aluminum		1	A-82557
355	25.4	25	3	2.4	100	0	ATB	Aluminum		1	A-81636

Ideal for Cordless Metal Cutter

Outer diameter (mm)	Bore (mm)	Ring (mm)	Kerf (mm)	Plate (mm)	No. of teeth	Rake	Tooth shape	Material	Note	Per pkg.	Part No.
---------------------	-----------	-----------	-----------	------------	--------------	------	-------------	----------	------	----------	----------



136	20		1.1	0.95	30			Metal		1	B-69428
136	20		1.1	0.95	45			Metal & Stainless		1	B-69434
150	20		1.1	0.95	33			Metal		1	B-69440
150	20		1.1	0.95	48			Metal & Stainless		1	B-69456

Cutting



Outer diameter (mm)	Bore (mm)	Ring (mm)	Kerf (mm)	Plate (mm)	No. of teeth	Rake	Tooth Shape	Material	Note	Per pkg.	Part No.
136	20		1.5	1.2	30	0	MTCG	Mild steel		1	B-07319
136	20		1.4	1.1	50	-15	ATB	Thin sheet metal		1	B-07325
136	20		1.1	0.95	56	0	SMTCG	Stainless/Mild steel		1	B-23117
150	20		1.5	1.2	32	0	MTCG	Mild steel		1	B-46296
150	20		1.4	1.1	52	-15	ATB	Thin sheet metal		1	B-47008
150	20		1.1	0.95	60	0	SMTCG	Stainless/Mild steel	Laser Slit	1	B-47014
150	20				32	0	TCG	Thick metal	Laser Slit	1	B-68301



(Metal Cutter)

Outer diameter (mm)	Bore (mm)	Ring (mm)	Kerf (mm)	Plate (mm)	No. of teeth	Rake	Tooth Shape	Material	Note	Per pkg.	Part No.
185	20		1.9	1.5	36	0	ATB	Mild steel		1	B-04628
185	20		2	1.6	38	0	MTCG	Mild steel		1	A-85438
185	20		2	1.6	48	0	MTCG	Thin mild steel		1	A-83967
185	20		1.7	1.3	70	-10	FTG	Corrugated steel plate		1	A-86446
185	20		1.85	1.5	48	0	SMTCG	Mild steel	Long Life	1	B-23357
185	20		1.8	1.5	56	0	SMTCG	Thin mild steel	Long Life	1	B-23391
185	20		1.6	1.3	64	0	SMTCG	Stainless/Mild steel	Laser Slit	1	B-31697



(Metal Cutting Saw)

Outer diameter (mm)	Bore (mm)	Ring (mm)	Kerf (mm)	Plate (mm)	No. of teeth	Rake	Tooth Shape	Material	Note	Per pkg.	Part No.
305	25.4		2.1	1.7	60	0	TCG	Mild steel		1	A-87242
305	25.4		2.4	2	60	0	TCG	Mild steel	Laser Slit	1	A-86723
305	25.4		2.5	2.2	60	0	TCG	Mild steel		1	A-81860
305	25.4		2.3	2	78	0	MTCG	Thin mild steel		1	A-87127
305	25.4		1.95	1.65	100	-3	SMTCG	Stainless/Mild steel	Laser Slit	1	B-23151

for CA5000



Outer diameter (mm)	Bore (mm)	Ring (mm)	Kerf (mm)	Plate (mm)	No. of teeth	Rake	Tooth Shape	Material	Note	Per pkg.	Part No.
118	20		14	6	6	5	90°	Aluminium composite		1	B-48832
118	20		18	6	6	5	135°	Aluminium composite		1	B-48860

TCT Saw Blade for DSC250



Outer diameter (mm)	Bore (mm)	Ring (mm)	Kerf (mm)	Plate (mm)	No. of teeth	Rake	Tooth Shape	Material	Note	Per pkg.	Part No.
110	15				24			Thread Rod Re-Bar		1	SC09002890

ACCESSORIES

▣ Jigsaw / Reciprosawing



Tungsten carbide tipped



Diamond grit



Grit size



Straight cutting



Curved cutting



Fine cut



Coarse cut



Thick material



Thin material



Ground teeth



Number of teeth per inch



Do not use orbital mode



Use coolant, cool

Jigsaw / Reciprosawing

Jig Saw blade

Teeth Type

Milled and side set teeth

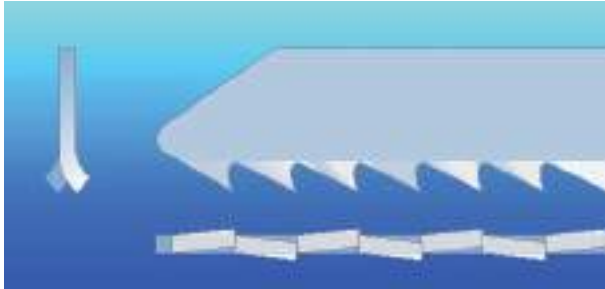

Ground and side set teeth



Milled and wavy set teeth



Ground and taper ground teeth



Teeth manufacture

Milled teeth

- Low cost type of manufacturing
- For general cutting
- Soft to hard materials
- Long blade life



Ground teeth

- Costly type of manufacturing
- Very sharp!
- Accurate, clean cut
- Soft to medium hard materials

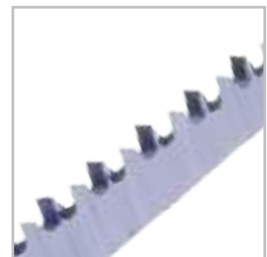

Production method

- **Side set:** each individual tooth is alternately bent to the left and to the right. Raker setting
Example: right, left, straight, etc. 
- **Wavy set:** row of teeth receives a wave shape
- **Ground:** blade body tapers to the rear (conical)

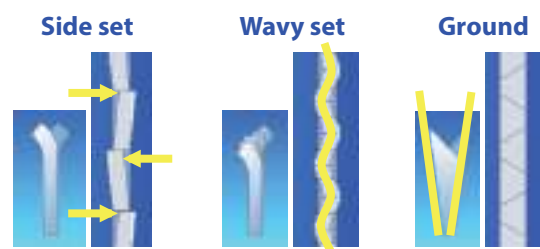

Jig Saw Blade material

- **HCS (High Carbon Steel)** for cutting softer materials such as wood or plastics.
- **HSS (High Speed Steel)** for cutting harder materials such as metals.
- **BiM (Bi-metal, HCS base and HSS teeth)** for cutting soft materials to hard materials such as wood, metal, plastics.
- **TC (Tungsten Carbide)** for cutting glass fiber reinforced plastic, cement-bonded fiberboards or plasterboard.

Jigsaw / Reciprosawing

Japanese Teeth Reciprosaw Blade



Feature

1. Japanese teeth for Sharp Edge!

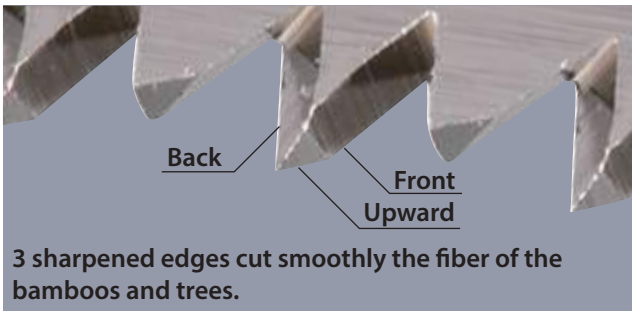

2. Clean Cutting Surface



Application

For Bamboo

15TPI

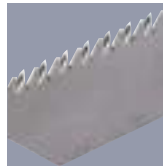

For Green Wood

8.5TPI

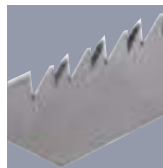

TC Reciprosaw Blade



Feature

Tungsten Carbide Tip

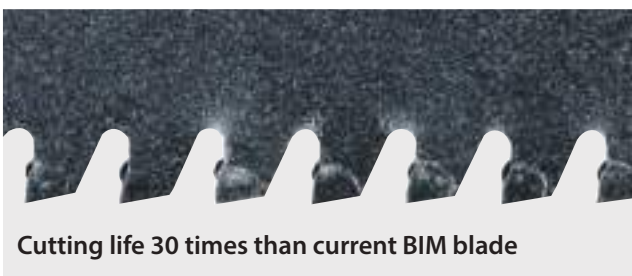

Application

For Cast Iron



For Stainless



Jigsaw / Reciprosawing

Makita type Jig Saw blade

For Model:
4300BA/B, 4326M, 4327M



Shape	No.	Wood Plywood (mm)	Plastics (mm)	Aluminum (mm)	Stainless Steel (mm)	Mild Steel (mm)	Features / Application	Working Length (mm)	Tooth Per Inch	Material	Type of cutting	Per pkg.	Part No.
Wood/ Basic													
	3	3-50	3-50	-	-	-	For general cutting	60	9	HCS		5	A-85868
	16	3-50	3-50	-	-	-	For scroll cutting	60	9	HCS		5	A-85830
Wood/ Fast													
	8	4-50	4-50	-	-	-	For fast cutting	60	8	HCS		5	A-85911
Wood/ Finish													
	9	4-50	4-50	-	-	-	For fast finish work	60	8	HCS		5	A-85927
	10	4-50	4-50	-	-	-	For fast finish work, especially suitable for plywood	60	9	HCS		5	A-85818
	10S	3-50	-	-	-	-	Splinter-free cuts in wood, requiring no sanding	62	13	HCS		5	A-85824
	BR-3	50	-	-	-	-	Splinter-free cuts in wood requiring no sanding	60	9	HCS		5	A-85933
Hardwood / Decorative veneers													
	2	3-50	3-50	2-6	-	2-6	For decorative veneers.	60	14	HSS		5	A-85852
	4	3-50	3-50	3-6	-	3-6	For hardwood, thick mild steel plate and tough plastics	60	9	HSS		5	A-85874
	17	2-50	2-50	2-6	-	2-6	Ideal for scroll cutting of decorative veneer	63	14	HSS		5	A-85846
Finish for decorative veneers													
	41	3-50	3-50	-	-	-	Reverse tooth for splinter-free cuts for tough plastic and decorative veneers	60	12	HCS		5	A-85880
	42	2-50	2-50	-	-	-	For decorative veneer	60	16	HSS		5	A-85896
Metal/ Basic													
	1	-	1-6	1-3	0.5-3	1-3	For mild steel. Also suitable for corrugated plastics and tough plastics	60	24	HSS		5	A-85802
	5	-	1.5-6	1-6	-	1-3	For mild steel	42	24	HSS		5	A-85905

Jigsaw / Reciprosawing

Bayonet type Jig Saw blade

For Model: DJV181, DJV182, DJV141, DJV142, DJV180, DJV140, JV183D, JV143D, JV0600, JV100D, J V101D, JV102D, JV103D DJR185, DJR145, JR102D, JR105D, 4326, 4327, 4328, 4329, 4350T/CT/FCT, 4351T/CT/FCT



Shape	No.	Wood Plywood (mm)	Plastics (mm)	Aluminum (mm)	Stainless Steel (mm)	Mild Steel (mm)	Features / Application	Working Length (mm)	Tooth Per Inch	Material	Type of cutting	Per pkg.	Part No.
Super Express Jig saw Blade													
	B-50	5-50	5-50	-	-	-	For fast finish work in wood and plastic	77	8.5-10.6	HCS	↑	5	B-06460
	B-51	-	-	-	1-3	1-8	Fast cut for mild steel, stainless steel	77	9.8-18.1	HSS	↑	5	B-06476
	B-52	5-50	5-50	3-35	3-5	3-8	Fast cut for universal materials	77	5.5-9.8	HSS	↑	5	B-06482
Wood/ Basic													
	B-13	4-65	4-65	-	-	-	For general cutting	70	8	HCS	↑	5	A-85656
	B-15	3-35	3-35	-	-	-	Ideal for cutting thin materials	50	12	HCS	↑	5	A-85678
	B-14	2-35	2-35	-	-	-	Ideal for cutting thin materials	50	18	HCS	↑	5	A-85662
	B-18	2-35	2-35	-	-	-	For scroll cutting	45	14	HCS	↻	5	A-85709
Wood/ Fast													
	58	4-65	4-65	-	-	-	For fast cutting	75	8	HCS	↑	5	A-86577
	B-16	5-65	5-65	-	-	-	For fast and rough cutting	75	6	HCS	↑	5	A-85684
	L-2	5-90	5-90	-	-	-	For fast and rough cutting	100	6	HCS	↑	5	A-86309
	B-16L	5-135	5-135	-	-	-	For fast and rough cutting	150	6	HCS	↑	5	792726-5
	B-17	5-60	5-60	-	-	-	For fast and scroll cutting	70	6	HCS	↻	5	A-85690
	B-8	4-65	4-65	-	-	-	Hook angle: 2 degrees	75	8	HCS	↑	5	A-85232
Wood/ Finish													
	59	4-65	4-65	-	-	-	For fast finish work	75	8	HCS	↑	5	A-86583
	B-10	3-65	3-65	-	-	-	For fast finish work, especially suitable for plywood	75	9	HCS	↑	5	A-85628
	B-11	3-60	3-60	-	-	-	For fast finish work in wood and plastics	75	9	HCS	↑	5	A-85634
	B-10S	3-50	-	-	-	-	Splinter-free cuts in wood requiring no sanding	65	13	HCS	↑	5	792691-8
	B-12	5-65	5-65	-	-	-	For fast finish work in wood and plastics	75	6	HCS	↑	5	A-85640
	L-1	5-90	5-90	-	-	-	Ideal for cutting thick materials	100	6	HCS	↑	5	A-86290
	B-29	2-35	2-35	-	-	-	For scroll cutting	42	16	HCS	↻	5	A-80400
	BR-13	5-65	-	-	-	-	Splinter-free cuts in wood, requiring no sanding	64	9	HCS	↑	5	A-85793
Hardwood / Decorative veneers													
	B-25	3-60	3-60	3-6	-	3-6	For hardwood, thick mild steel plate and hard plastics.	75	9	HSS	↑	5	A-85765
	B-26	3-60	3-60	3-10	-	3-10	For scroll cutting in hardwoods and for hard plastics.	70	9	HSS	↑	5	A-85771















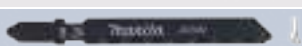



Jigsaw / Reciprosawing

Shape	No.	Wood Plywood (mm)	Plastics (mm)	Aluminum (mm)	Stainless Steel (mm)	Mild Steel (mm)	Features / Application	Working Length (mm)	Tooth Per Inch	Material	Type of cutting	Per pkg.	Part No.
-------	-----	-------------------	---------------	---------------	----------------------	-----------------	------------------------	---------------------	----------------	----------	-----------------	----------	----------

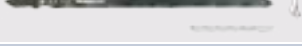
Finish for decorative veneers

	B-19	3-50	3-50	-	-	-	Reverse tooth for splinter-free cuts. For tough plastics and decorative veneers	65	12	HCS		5	A-85715
---	------	------	------	---	---	---	---	----	----	-----	---	---	---------

Metal/ Basic

	51	-	1.5-6	1.5-6	1-3	1-3	For mild steel	65	24	HSS		5	A-86561
	B-22	-	1-6	1-3	1-3	1-3	For mild steel, tough plastics. Especially for thin metal plate	50	24	HSS		2	B-01323
	B-24	-	1-3	1-2	0.5-2	0.5-2	For very thin metal plate	50	32	HSS		5	A-85737
	B-23	3-35	3-35	2-6	-	2-6	For decorative veneers, medium-thick metal plate	50	14	HSS		5	A-85759
	B-27	-	1-6	1-3	1-3	1-3	For scroll cutting in mild steel	50	24	HSS		5	A-85743
	B-32	-	-Ø65	-Ø65	-	1.5-3	For thin metal plate, pipes and profiles. Also aluminium and plastics.	107	18	HSS		5	B-10431
	B-33	-	-Ø65	-Ø65	-	2-3	For medium-thick metal plate, pipes and profiles. Also Aluminium	107	14	HSS		5	B-10447
	B-34	-	1.5-6	1.5-3	1.5-3	1.5-3	For mild steel, tough plastics. Especially for thin metal plate	50	18	HSS		5	B-10453
	B-35	*	-Ø114	2-6	-	-	For sandwich materials * Wood with nails -Ø120	154	14	Bi-Metal		3	B-10469



For Plastics

	B-21	-	3-60	1-10	-	-	For plastics finish work	75	12	HSS		5	A-85721
---	------	---	------	------	---	---	--------------------------	----	----	-----	---	---	---------

For Rubber

	B-K	-	-	-	-	-	Ideal for cutting of paper, cork, rubber, leather	75	-	HCS	-	5	A-80416
---	-----	---	---	---	---	---	---	----	---	-----	---	---	---------









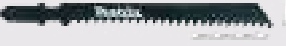

For Fiber Cement

	B-60	-	-	-	-	-	Fiber Cement/Plaster Board 5-50, FRP/Plastic 5-20	75	6	TC/HM	-	3	B-06890
	B-61	-	-	-	-	-	Fiber Cement/Plaster Board 5-80, FRP/Plastic 5-50	105	6	TC/HM	-	3	B-06909

Economy type Jig Saw blade

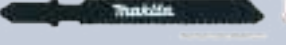
For Model:

DJV181, DJV182, DJV141, DJV142, DJV180, DJV140, JV183D, JV143D, JV0600, JV100D, JV101D, JV102D, JV103D, DJR185, DJR145, JR102D, JR105D, 4326, 4327, 4328, 4329, 4350T/CT/FCT, 4351T/CT/FCT

Shape	Wood Plywood (mm)	Plastics (mm)	Aluminum (mm)	Stainless Steel (mm)	Mild Steel (mm)	Features / Application	Working Length (mm)	Tooth Per Inch	Material	Type of cutting	Per pkg.	Part No.
	4-50	-	-	-	-	Wood / Basic	74	8	HCS		5	D-34877
	4-50	-	-	-	-	Wood / Fast	74	6	HCS		5	D-34883
	4-50	-	-	-	-	Wood / Fast, Curved	74	6	HCS		5	D-34899
	-	-	-	-	1-3	Metal / Basic	51	21	HSS		5	D-34908
	4-50	-	-	-	-	Wood / Finish	74	9	HCS		5	D-44214

Jigsaw / Reciprosawing

Jig Saw Blade 100pc/ pack





Type	No.	Application	Part No.
 Bayonet type	B-10	Wood	B-07674

Type	No.	Application	Part No.
 Makita type	No.1	Metal	B-07783
	No.2	Wood	B-07799
	No.3	Wood	B-07808

Makita Jig Saw blade assortment

*Super Express Jig saw blade



Type	Five different jig saw blades in one packet					Part No.
 Makita type	No.1	No.2	No.3	No.8	No.10 S	A-86882
 B type	B-10S	B-13	B-16	B-22	B-23	A-86898
 B type	B-50	B-51	B-52	-	-	*B-06292

Recipro saw blades for Model JR1000FT, JR102D

HCS / High carbon steel for cutting softer materials such as wood or plastics HSS / High speed steel for cutting harder materials such as metals, aluminium, and non-metals For Cutting



Shape	No.	Wood Plywood (mm)	Plastics (mm)	Aluminum (mm)	Stainless Steel (mm)	Mild Steel (mm)	Features / Application	Working Length (mm)	Tooth Per Inch	Material	Type of cutting	Per pkg.	Part No.
Wood/ Fast													
	B-8	4-65	4-65	-	-	-	Ideal for fast cutting of wood and plastics. Hook angle: 2 degrees	75	8	HCS		5	A-85232
Wood/ Finish													
	B-10	3-65	3-65	-	-	-	For fast finish work, especially in plywood.	75	9	HCS		5	A-85628
Finish for decorative veneers													
	B-19	3-50	3-50	-	-	-	Reverse tooth for splinter-free cuts. For tough plastics and decorative veneers	65	12	HCS		5	A-85715
	B-19S	3-25	3-25	-	-	-	Short type of B-19	43	12	HCS		5	B-04933
Metal/ Basic													
	B-22	-	1-6	1-3	1-3	1-3	For mild steel, tough plastics. Especially for thin metal plate	50	24	HSS		2	B-01323
Metal/ Thin cutting													
	B-24	-	1-3	1-2	0.5-2	0.5-2	For very thin metal plate	50	32	HSS		5	A-85759

For Paper, Cork, Rubber, Leather







Shape	No.	Foam polystyrene	Card board	Rubber	Leather	-	Features / Application	Working Length (mm)	Tooth Per Inch	Material	Type of cutting	Per pkg.	Part No.
	B-K	50	30	10	5	-	Ideal for cutting of paper, cork, rubber and leather.	75	-	HCS	-	5	A-80416

Jigsaw / Reciprosawing

Recipro saw blade

Type	Teeth per inch	Overall length (mm)	Blade thickness (mm)	Application	Tooth Material	Per pkg.	Part No.
Super Express Recipro saw Blade							
	7-18	152	0.9	Fast cut for metal (Iron/steel 1.5-8.0mm, Plastic 5-77mm)	Bi-Metal	5	B-05038
	6-11	152	0.9	Fast cut for non-ferrous metal, aluminum, plastics, wood with nail, steel (Iron/steel 5-8mm, Plastic 5-77mm, Wood 5-77mm)	Bi-Metal	5	B-05044
	6-10	203	1.0	Fast cut for wood	HCS	5	B-05153



For Metal / Basic

Type	Teeth per inch	Overall length (mm)	Blade thickness (mm)	Application	Tooth Material	Per pkg.	Part No.
	14	152	0.9	metal plate 3-8mm pipe 10-100mm	Bi-Metal	5	B-16841
	14	225	0.9	metal plate 3-8mm pipe 10-175mm	Bi-Metal	5	B-16776
	18	152	0.9	For thin metal 1.5-4.0mm. For iron pipe 100mm dia or less.	Bi-Metal	5 25	B-05169 B-05169-25
	18	225	0.9	metal plate 1.5-4mm pipe 5-175mm	Bi-Metal	5	B-16782
	24	152	0.9	metal plate 0.7-3mm pipe 5-100mm	Bi-Metal	5	B-16835
	24	225	0.9	metal plate 0.7-3mm pipe 5-175mm	Bi-Metal	5	B-43169
	10-14	305	0.9	metal tubing 5-200mm, Aluminum & plastic 5-20mm	Bi-Metal	5	B-16857

For Metal / Heavy

	14+18	152	1.1	metal plate 3-8mm, pipe <100mm	Bi-Metal	5	B-43131
	14+18	225	1.1	metal plate 3-8mm, pipe <175mm	Bi-Metal	5	B-43175
	14+18	305	1.1	metal plate 3-8mm, pipe <250mm	Bi-Metal	5	B-43206
	8+10	152	1.1	thick sheet metal 4-12mm, pipe <100mm (fast cut)	Bi-Metal	5	B-43147
	8+10	225	1.1	thick sheet metal 4-12mm, pipe <175mm (fast cut)	Bi-Metal	5	B-43181
	8+10	305	1.1	thick sheet metal 4-12mm, pipe <250mm (fast cut)	Bi-Metal	5	B-43212
	10-14	152	1.25	thick sheet metal 2-10mm, pipe <100mm (fine cut)	Bi-Metal	5	B-43153
	10-14	225	1.25	thick sheet metal 2-10mm, pipe <175mm (fine cut)	Bi-Metal	5	B-43197
	10-14	305	1.25	thick sheet metal 2-10mm, pipe <250mm (fine cut)	Bi-Metal	5	B-43228



For Metal / Heavy / Curve shape

	14+18	152	1.1	metal plate 3-8mm, pipe <100mm	Bi-Metal	5	B-55815
	14+18	225	1.1	metal plate 3-8mm, pipe <175mm	Bi-Metal	5	B-55821
	14+18	305	1.1	metal plate 3-8mm, pipe <225mm	Bi-Metal	5	B-55837

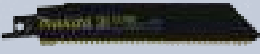

Jigsaw / Reciprosawing

Type	Teeth per inch	Overall length (mm)	Blade thickness (mm)	Application	Tooth Material	Per pkg.	Part No.
------	----------------	---------------------	----------------------	-------------	----------------	----------	----------



For Metal / Heavy / TC

	8	100	1.25	thick sheet metal 4-12mm, pipe <50mm	TC/HM	1	B-55566
	8	152	1.25	thick sheet metal 4-12mm, pipe <100mm	TC/HM	1	B-55572
	8	228	1.25	thick sheet metal 4-12mm, pipe <175mm	TC/HM	1	B-55588
	8	305	1.25	thick sheet metal 4-12mm, pipe <250mm	TC/HM	1	B-55594

For Wood / Basic





No.3026 	10	150	1.0	For wood, plywood 5mm-90mm	HCS	5	A-02319
No.3025 	10	250	1.25	For thick wood 5mm-190mm	HCS	5	B-00767

For Wood / Fast

No.22B 	6	150	1.0	For fast finish work in wood 10mm-90mm	HCS	5	792707-9
No.3019 	4	150	1.0	For fast and rough cutting in thick wood. 20mm-90mm	HCS	5	A-02303
No.3030 	6	300	1.25	For roughing work on thick wood. 10mm-250mm	HCS	5	B-03030

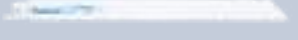

for Wood and Metal

*White Lacquered, **Unlacquered

	6	152	1.25	For wood with nails 10mm-100mm, Glass Fiber 8-50mm	Bi-Metal	5	B-05175
	10	152	0.9	For pallets, wood with nails 5-100mm sheet metal, pipes, aluminum profiles 3-12mm	Bi-Metal	5	B-31843
	10	228	0.9	For pallets, wood with nails 5-175mm sheet metal, pipes, aluminum profiles 3-12mm	Bi-Metal	5	B-31859
	5-8	305	1.25	Wood with nails/metal, chipboards (10-250mm), aerated concrete (10-250mm), plastics/Glass fibre reinforced plastics, profiles (5-60mm)	Bi-Metal	3	B-10637
	10-14	152	0.9	wood with metal 5-100mm, aluminum 3-10mm, plastic 3-100mm	Bi-Metal	5	B-43240
	10-14	225	0.9	wood with metal 5-175mm, aluminum 3-10mm, plastic 3-175mm	Bi-Metal	5	B-43262

Type	Teeth per inch	Overall length (mm)	Blade thickness (mm)	Application	Tooth Material	Per pkg.	Part No.
------	----------------	---------------------	----------------------	-------------	----------------	----------	----------





For Wood and Metal / Heavy

	5-8	152	1.6	wood with metal, chipboard 10-100mm	Bi-Metal	5	B-43234
	5-8	225	1.6	wood with metal, chipboard 10-175mm	Bi-Metal	5	B-43256
	5-8	305	1.6	wood with metal, chipboard 10-235mm	Bi-Metal	5	B-43278



Jigsaw / Reciprosawing

Type	Teeth per inch	Overall length (mm)	Blade thickness (mm)	Application	Tooth Material	Per pkg.	Part No.
------	----------------	---------------------	----------------------	-------------	----------------	----------	----------





For Special Purpose

	-	225	1.5	Insulation Material, Glass Wool, Stone Wool (10-175mm)	HCS	2	B-52118
	-	300	1.5	Insulation Material, Glass Wool, Stone Wool (10-250mm)	HCS	2	B-52124
	-	400	1.5	Insulation Material, Glass Wool, Stone Wool (10-300mm)	HCS	1	B-52130
	18	152	1.0	For stainless steel plate 2mm-4mm, stainless steel pipe 80mm dia or less, fiber glass	TC/HM	2	B-07250
	-	228	1.0	Cast-steel pipe 150mm dia or less, for red brick 10-175mm, FRP/Epoxy 3-175mm	Diamond Grit	2	B-31871

For Ice/Frozen Material

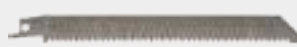
	3	305	1.25	For Ice 10-250 mm	Stainless Steel	1	B-10609
	6	228	1.2	For Ice 10-175 mm	Stainless Steel	1	B-30564
	10	228	1.2	For Ice 10-175 mm	Stainless Steel	1	B-30570





For Wood / Clean cut

	8.5	190	0.6	For planting green wood < φ100mm, wood < 100mm	HCS	1	B-56580
	15	190	0.6	For bamboo < φ100mm, wood < 100mm, PVC < φ100mm	HCS	1	B-56596
	8.5	225	0.9	For planting green wood < φ140mm, wood < 140mm	Bi-Metal	1	B-57386
	15	225	0.9	For bamboo < φ140mm, wood < 140mm, PVC < φ140mm	Bi-Metal	1	B-57392

Economy type Recipro saw blade

Type	Teeth per inch	Overall length (mm)	Blade thickness (mm)	Application	Tooth Material	Per pkg.	Part No.
------	----------------	---------------------	----------------------	-------------	----------------	----------	----------

For Metal

	18	152	0.9	metal plate 1.5-4mm pipe 5-100mm	Bi-Metal	2	D-51633
	18	225	0.9	metal plate 1.5-4mm pipe 5-175mm	Bi-Metal	2	D-51661
	24	152	0.9	metal plate 0.7-3mm pipe 5-100mm	Bi-Metal	2	D-51649
	24	225	0.9	metal plate 0.7-3mm pipe 5-175mm	Bi-Metal	2	D-51677

Jigsaw / Reciprosawing

Board Cutter Blade



For Model:
DSD140, DSD180, SD100D

Blade length (mm)	Blade width (mm)	Blade thickness (mm)	Application	Tooth Material	Per pkg.	Part No.
55	18	0.55	Plasterboard (<30mm)	HCS	2	B-49703
55	18	0.55	Wood (<30mm)	HCS	2	B-49719

Scroll saw blade

For model: SJ401

Application	No of teeth per inch	Pc per pkg.	Part No.
Straight line and large curve on wood	60	5	A-31099
Optimal switching curve and small area on wood	70	5	A-31108



Band saw blade



*Wave teeth
Thickness : 0.5 mm, Length : 2,240 mm

Model No.	Type	Width (mm)	No. of teeth per inch	Application	Part No.
LB1200F	Carbon steel (3pcs./set)	16	4	Wood/ for cross-cut	B-16667
		13	4	Wood/ for universal	B-16673
		6	6	Wood/ for curve-cut	B-16689
		16	14	Nonferrous metal	B-16695

Width : 13 mm, Thickness : 0.5 mm, Length : 1,140 mm

DPB180, 2106, 2107F, 2107FW	Carbon steel (3pcs./set)	More than 5 mm	6	Wood	792567-9
		4 mm- 5 mm	14	Plastics and non-ferrous metal. Mild steel, cast steel and cast iron.	792560-3
		Less than 4 mm	18		792559-8
		Less than 4 mm	24		792558-0
	Bi-Metal (1pc.)	More than 5 mm	14	Plastics and non-ferrous metal. Mild steel, cast steel and cast iron. Hard steel and stainless steel.	792557-2
		4 mm- 5 mm	18		792556-4
		Less than 4 mm	24		*194692-6

Width : 13 mm, Thickness : 0.5 mm, Length : 835 mm

DPB181	Bi-Metal (5pc.)	3mm-6 mm	14	Plastics and non-ferrous metal. Mild steel, cast steel and cast iron. Hard steel and stainless steel.	*B-40543
		2 mm- 3 mm	18		*B-40559

Width : 13 mm, Thickness : 0.5 mm, Length : 730 mm

DPB184	Bi-Metal	13mm	14	Stainless steel, non-ferrous metal	E-04101
			18		E-04117
			24		E-04123

ACCESSORIES

▣ Brushing



Brushing

Brushes for Grainder



Wire Type



Crimped
Ideal for light rust removal



Knotted
Ideal for heavy work



Knotted2
Ideal for especially heavy work



Fine



Coarse

Shape Type



Cup type
Effective for flat or rugged surface



Wheel type
Effective for working at spot



Bevel type
Effective for working at corner

Wire brush

For Model:
A: 100mm Disc / Angle Grinder
B: 125, 150mm Angle Grinder
C: 180, 230mm Angle Grinder
D: 230mm Angle Grinder

Wire Cup brush, Knotted wire 2

0.5mm knotted steel wire2
(Ideal for especially heavy work. Knotted steel wire is twisted more stronger than 1.)



Wire Cup brush, Crimped wire

0.3mm crimped steel wire
(Ideal for light rust removal from flat surfaces and edges.)



For Model	Size	Spindle thread	Part No.
A	60mm	M10 x 1.5	D-24066
B	60mm	M14 x 2	D-24072
A	75mm	M10 x 1.5	D-24088
B	75mm	M14 x 2	D-24094
C	100mm	M14 x 2	D-29284

Wire wheel brush, Knotted wire

0.5mm knotted steel wire
(Effective for heavy duty cleaning at spot.)



For Model	Size	Spindle thread	Part No.
B, C	100mm	M14 x 2	D-29555
B, C	115mm	M14 x 2	D-29561
B, C	125mm	M14 x 2	D-29577
D	175mm	M14 x 2	D-45777

Wire Cup brush, Knotted wire

0.5mm knotted steel wire1
(Ideal for heavy work for fast cleaning of large surface.)



For Model	Size	Spindle thread	Part No.
A	60mm	M10 x 1.5	D-24103
B	60mm	M14 x 2	D-24119
A	75mm	M10 x 1.5	D-24125
B	75mm	M14 x 2	D-24131

Wire brush wheel 120

(For rust removal)
For Model: 9741



Part No.
794382-7

Nylon brush wheel

For Model: 9741



Application	Part No.
120-80 Coarse	794384-3
120-100 Medium	794379-6
120-240 Fine	794383-5

ACCESSORIES

▣ Bonded Abrasive



Long life



Flexible



Always use back up pad

Bonded Abrasive

Types of Wheels



Grinding wheel

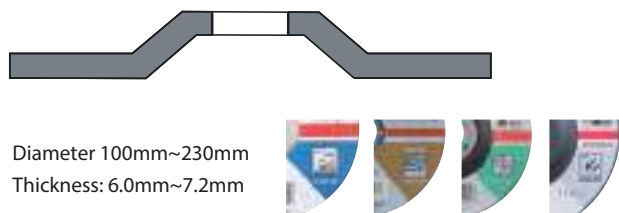

Thin cut-off wheel (Flat)



Flexible grinding wheelThin cut-off wheel (Depressed)

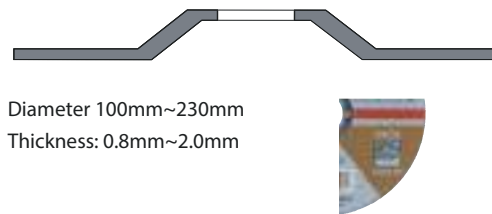

Cut-off wheel (Flat)



Cut-off wheel (Depressed)

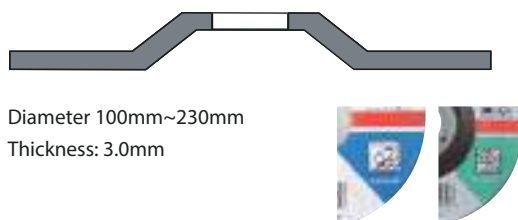

Bonded Abrasive

Abrasive Disc



How to read the spec.

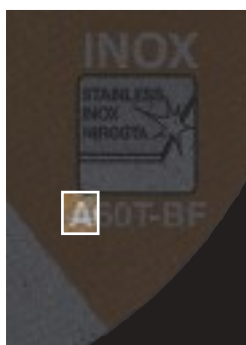

Aluminum Oxide Group

Brown Fused Aluminum : A



Single Aluminum Oxide : SA



White Aluminum Oxide : WA



Alumina Zirconium : Z



Silicon Oxide Group

Black Silicon Carbide : C



Green Silicon Carbide : CG

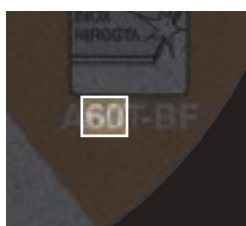

Grit Size

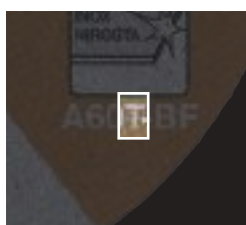
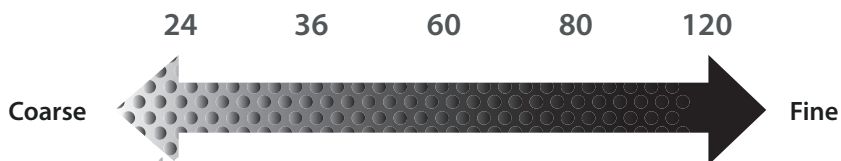

Hardness of grinding wheel

Closer to A, softer grinding wheel is
Closer to Z, harder grinding wheel is

Soft grinding wheel ► Hard work piece
Hard grinding wheel ► Soft work piece

Very Soft	Soft	Middle	Hard	Very Hard
A - G	H - K	L - O	P - S	T - Z

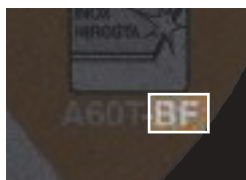

Type of Bond

BF : Reinforced resinoid bond
V : Vitrified bond

Abrasive Disc Series for Cordless Angle Grinder



The combination of new Grinding Wheel series and DC Grinder increases the work amount by 1 charge dramatically!

Flexible grinding wheel	2in1 abrasive wheel	0.8mm thin cutting wheel
		
Grinding	Cutting + Deburring	Cutting

Feature of DC series

1. Efficiency is high so shortens a working time!
It is decreased in the time for impossible posture, and fatigue to a body decreases.
2. Amount of grinding per 1 charged battery is up!!
Reduce charge number of times in the job site.

Flexible grinding wheel



Feature

1. Ideal for cordless tools
2. Less tapping & Less vibration

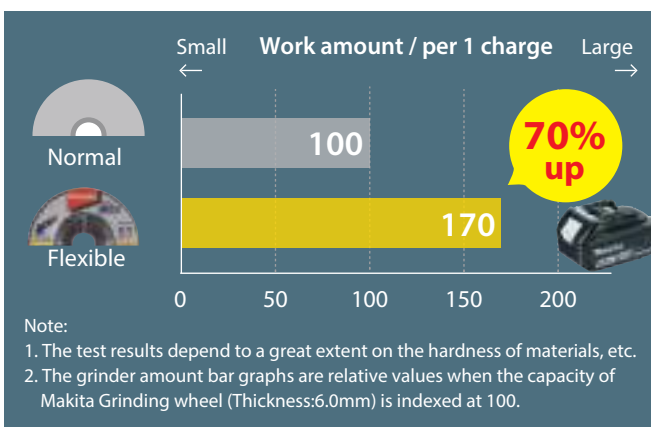

2 in 1 abrasive wheel



Features

1. Ideal for cordless tools

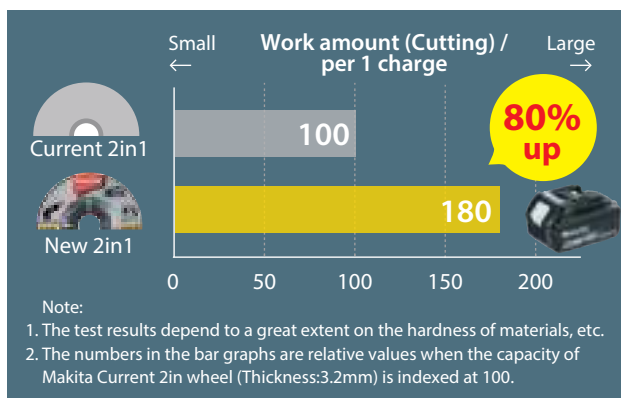

Suitable for cutting & deburring

2. Cutting and Deburring are possible in one disc

Cutting



Deburring



Thin 0.8mm cutting wheel



2. Less burr of materials



0.8mm



2.5mm



3. Less dust of materials



0.8mm



2.5mm



Features

1. Ideal for cordless tools

(A work load per 1 charge improves.)

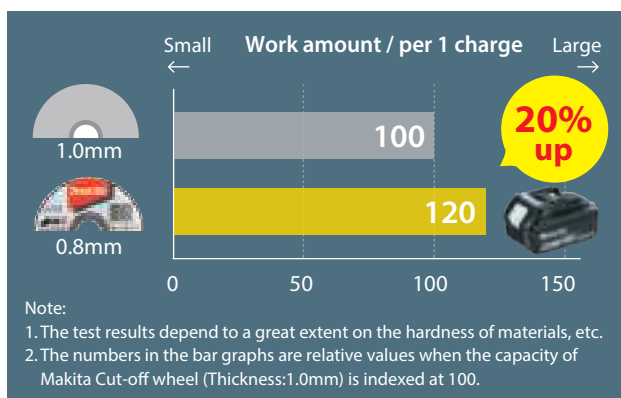

2.5mm thickness double reinforced abrasive cut-off wheel



Features

1. Thinner



2. Less burred



New 2.5mm thickness

Current 3.0mm thickness

3. Long life

Thanks to thin thickness, this item is fast cut.

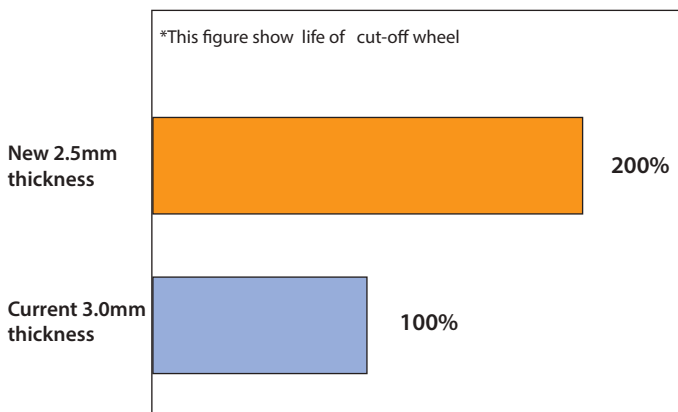

4. Fast cut

Thanks to new material, double reinforced, this item is long life.

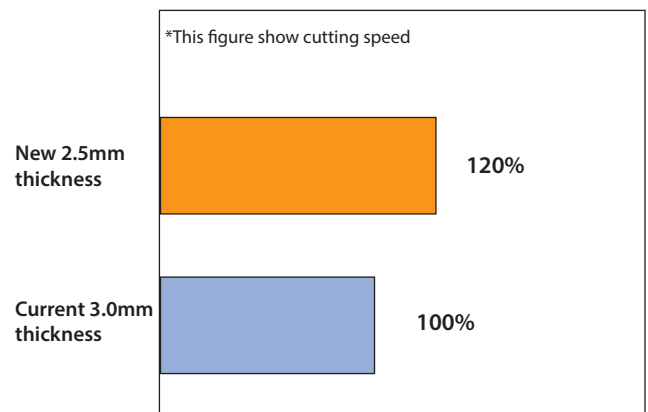

Abrasive cut-off wheel

Abrasive cut-off wheel series for portable cut-off

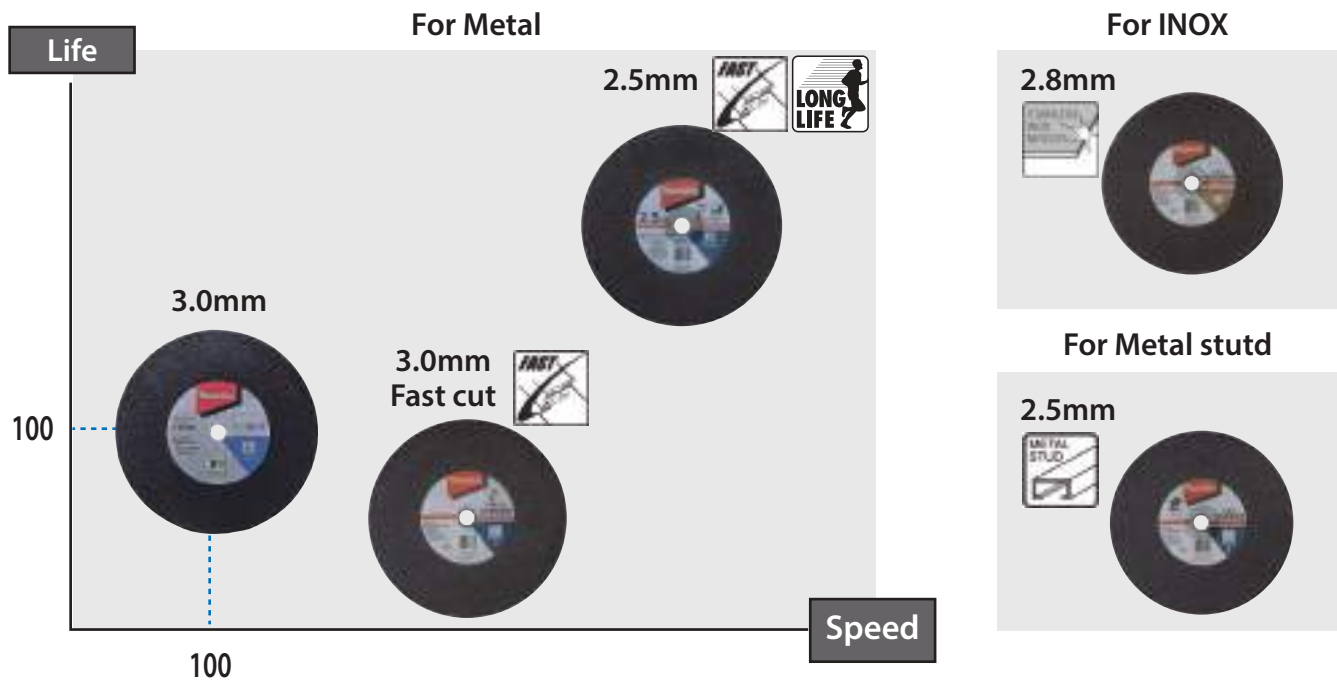

Abrasive Cut-off wheel Fast cut type



Feature

1. Fast cutting

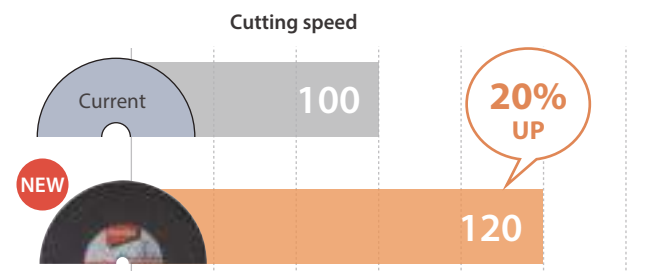

* The test results depend to a great extent on the hardness of materials, etc.
 * The number in the bar graphs are relative values when the capacity of current wheel is indexed at 100.

2. Smooth cutting



3. Less burr and burning



Current

NEW

Abrasive cut-off wheel

Abrasive Cut-off wheel for Metal stud



Feature

1. Thinner blade & the optimum bonding

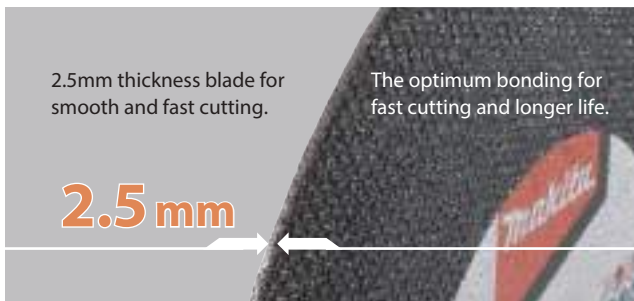

2. Ideal for cordless tools

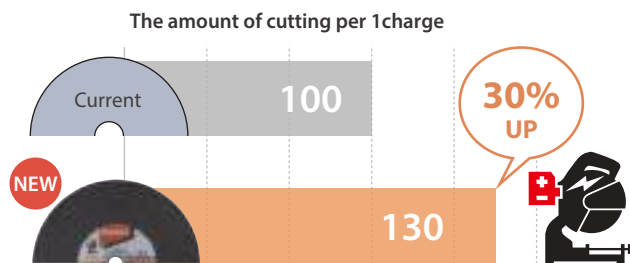

* The test results depend to a great extent on the hardness of materials, etc.
 * The number in the bar graphs are relative values when the capacity of current wheel is indexed at 100.

Abrasive Cut-off wheel for INOX



Feature

1. Thinner blade & the optimum bonding



2. Long life

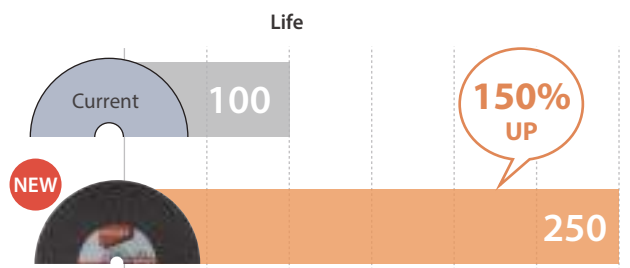

* The test results depend to a great extent on the hardness of materials, etc.
 * The number in the bar graphs are relative values when the capacity of current wheel is indexed at 100.

Bonded Abrasive

Grinding wheel



Three-star range

★★★



Size (mm)	Grit	Per pkg.	Part No.
100 x 6 x 16	A36P	1	A-80911(EN)
100 x 6 x 16	A36P	1	B-46246 (EN)
115 x 6 x 22.23	A36P	1	741458-1
115 x 6 x 22.23	A36P	1	A-80927(EN)
125 x 6 x 22.23	A36P	1	A-80933(EN)
150 x 6 x 22.23	A36P	1	A-84981(EN)
180 x 6 x 22.23	A24P	1	741425-6
180 x 6 x 22.23	A36P	1	741426-4
180 x 6 x 22.23	A36P	1	A-80949(EN)
230 x 6 x 22.23	A36P	1	A-80955(EN)

Two-star range

★★

Size (mm)	Grit	Per pkg.	Part No.
100 x 6 x 16	A24R	1	D-18443(EN)
115 x 6 x 22.23	A24R	1	D-18459(EN)
125 x 6 x 22.23	A24R	1	D-18465(EN)
180 x 6 x 22.23	A24R	1	D-18471(EN)
230 x 6 x 22.23	A24R	1	D-18487(EN)



Three-star range

★★★



Size (mm)	Grit	Per pkg.	Part No.
100 x 6 x 16	WA36N	1	A-80852(EN)
100 x 6 x 16	WA36N	1	B-46349 (EN)
125 x 6 x 22.23	WA36N	1	B-46361 (EN)
180 x 6 x 22.23	WA36O	1	A-80880(EN)
180 x 6 x 22.23	WA36O	1	B-46377 (EN)
230 x 6 x 22.23	WA36O	1	A-80896(EN)
230 x 6 x 22.23	WA36O	1	B-46383 (EN)



Two-star range

★★



Size (mm)	Grit	Per pkg.	Part No.
115 x 6 x 22.23	C24R	1	D-18502(EN)



Three-star range

★★★



Size (mm)	Grit	Per pkg.	Part No.
100 x 6 x 16	A24R	1	B-21107(EN)
180 x 6 x 22.23	A24R	1	B-21135(EN)

Flexible grinding wheel



Always use back-up pad
Three-star range

★★★



Size (mm)	Grit	Per pkg.	Part No.
100 x 2 x 16	AC46	1	B-18203
100 x 2 x 16	AC60	1	A-85139
100 x 2 x 16	AC80	1	B-18219
100 x 2 x 16	AC120	1	B-18225
100 x 3 x 16	AC36	1	B-18231
100 x 3 x 16	AC46	1	B-18247
100 x 3 x 16	AC60	1	B-18253
100 x 3 x 16	AC80	1	B-18269
115 x 3 x 22.23	AC36	1	B-18275(EN)
180 x 3 x 22.23	AC36	1	B-18356
180 x 3 x 22.23	AC60	1	A-88490

XLOCK



Grinding wheel/ Metal

Size (mm)	Grit	Per pkg.	Part No.
100 x 6 x 22.23	A36P	1	E-00480(EN)
115 x 6 x 22.23	A36P	1	E-00365(EN)
125 x 6 x 22.23	A36P	1	E-00393(EN)

Grinding wheel/ Stainless

100 x 6 x 22.23	WA36N	1	E-00496(EN)
115 x 6 x 22.23	WA36N	1	E-00371(EN)
125 x 6 x 22.23	WA36N	1	E-00402(EN)

Thin Cut-off wheel (Flat)

100 x 1.2 x 22.23	A60T	1	E-00505(EN)
115 x 1.2 x 22.23	A60T	1	E-00387(EN)
125 x 1.2 x 22.23	A60T	1	E-00418(EN)

Bonded Abrasive



Always use back-up pad
Three-star range

★★★



Size (mm)	Grit	Per pkg.	Part No.
100 x 2 x 16	WA46	1	B-18421
100 x 2 x 16	WA60	1	B-18437
100 x 2 x 16	WA80	1	B-18443
100 x 2 x 16	WA120	1	B-18459
100 x 3 x 16	WA36	1	B-18465
100 x 3 x 16	WA46	1	B-18471
100 x 3 x 16	WA60	1	B-18487
100 x 3 x 16	WA80	1	B-18493
180 x 3 x 22.23	WA36	1	B-18580
180 x 3 x 22.23	WA60	1	B-18605



Always use back-up pad
Three-star range

★★★



Size (mm)	Grit	Per pkg.	Part No.
100 x 3 x 16	GC60P	1	B-51356

Flexible grinding wheel ideal for cordless angle grinder



Needless to use Back up pad
Four-star range

★★★★



Size (mm)	Grit	Per pkg.	Part No.
100x4.0x16	WA36P	1	B-52392(EN)

Thin Cut-off wheel ideal for cordless angle grinder



Four-star range

★★★★



Type A: Flat wheel
Type B: Depressed center wheel

Size (mm)	Grit	Type	Per pkg.	Part No.
100 x 0.8 x 16	Z60T	A	1	B-45711(EN)

Back up pad for Flexible grinding wheel



Size	Per pkg.	Part No.
for 100mm	1	B-20476
for 180mm	1	B-20498

Thin Cut-off wheel



Three-star range

★★★

Type A: Flat wheel
Type B: Depressed center wheel



Size (mm)	Grit	Type	Per pkg.	Part No.
100 x 1.0 x 16	A60T	A	1	B-12201(EN)
100 x 1.0 x 16	A60T	A	12 (Plastic Case)	B-12201-12(EN)
115 x 1.0 x 22.23	A60T	A	1	B-12217(EN)
125 x 1.0 x 22.23	A60T	A	1	B-12239(EN)
125 x 1.0 x 22.23	A60T	A	12 (Plastic Case)	B-12239-12(EN)
150 x 1.6 x 22.23	A60T	A	1	B-12251(EN)
180 x 1.6 x 22.23	A60T	A	1	B-12267(EN)
230 x 1.9 x 22.23	A60T	A	1	B-12273(EN)

Bonded Abrasive

Two-star range



Size (mm)	Grit	Type	Per pkg.	Part No.
100 x 1.0 x 16	WA60T	A	1	D-18758(EN)
115 x 1.2 x 22.23	WA60T	A	1	D-18764(EN)
125 x 1.2 x 22.23	WA60T	A	1	D-18770(EN)
125 x 1.2 x 22.23	WA60T	A	10 (Can)	D-18770-10(EN)
180 x 2 x 22.23	WA36R	A	1	D-18786(EN)
100 x 1.2 x 16	WA46R	A	1	D-65947
100 x 1.2 x 16	WA46R	A	12	D-65947-12
115 x 1.2 x 22.23	WA46R	A	1	D-65953
115 x 1.2 x 22.23	WA46R	A	12	D-65953-12
125 x 1.2 x 22.23	WA46R	A	1	D-65969
180 x 1.2 x 22.23	WA46R	A	1	D-65975

Cut-off wheel



Three-star range



Type A: Flat wheel

Type B: Depressed center wheel



Size (mm)	Grit	Type	Per pkg.	Part No.
100 x 2.5 x 16	A30R	A	1	A-85298(EN)
100 x 2.5 x 16	A30R	A	1	B-46399 (EN)
125 x 2.5 x 22.23	A30R	A	1	A-85313(EN)
180 x 2.5 x 22.23	A30R	A	1	A-85329(EN)
180 x 2.5 x 22.23	A30R	A	1	B-46420 (EN)
230 x 2.5 x 22.23	A30R	A	1	A-85335(EN)
230 x 2.5 x 22.23	A30R	A	1	B-46436 (EN)
100 x 3 x 16	A30T	B	1	A-83587(EN)
115 x 3 x 22.23	A30T	B	1	A-83593(EN)
125 x 3 x 22.23	A30T	B	1	A-83602(EN)
180 x 3 x 22.23	A30T	B	1	A-83618(EN)
230 x 3 x 22.23	A30T	B	1	A-83624(EN)

Two-star range



Size (mm)	Grit	Type	Per pkg.	Part No.
115 x 2.5 x 22.23	A30S	A	1	D-18661(EN)
125 x 2.5 x 22.23	A30S	A	1	D-18677(EN)
150 x 2.5 x 22.23	A30S	A	1	D-29402(EN)
230 x 2.5 x 22.23	A30S	A	1	D-18699(EN)
100 x 3 x 16	A30S	B	1	D-18552(EN)
115 x 3 x 22.23	A30S	B	1	D-18568(EN)
125 x 3 x 22.23	A30S	B	1	D-18574(EN)
180 x 3 x 22.23	A30S	B	1	D-18580(EN)
230 x 3 x 22.23	A30S	B	1	D-18596(EN)



Two-star range



Size (mm)	Grit	Type	Per pkg.	Part No.
230 x 3 x 22.23	C30S	B	1	D-18649(EN)

2in1 grinding wheel ideal for Cordless Angle Grinder



Appropriate wheel cover is required

Four-star range



Size (mm)	Grit	Per pkg.	Part No.
100x2.2x16	SA46P	1	B-51649 (EN)
125x2.2x22.23	SA46P	1	B-51655 (EN)

Abrasive cut-off wheel for cordless portable cut-off



Specialized

Size (mm)	Grit	Rough or Smooth	G.F.Q'ty	Per pkg.	Part No.
355x2.5x25.4	A36P	-	2.0G	1	B-64696

Bonded Abrasive

Abrasive cut-off wheel for portable cut-off



Four-star range



Size (mm)	Grit	Rough or Smooth	G.F.Q'ty	Per pkg.	Part No.
355x2.5x25.4	A36P	-	2.0G	1	B-49448

Three-star range



Size (mm)	Grit	Rough or Smooth	G.F.Q'ty	Per pkg.	Part No.
355x3x25.4	A36P	Rough	1.0G	5	B-10730-5
355x3x25.4	A36P	Rough	1.0G	25	B-10730-25
355x3x25.4	A36P	Smooth	1.0G	1	A-89545
405x3x25.4	A36P	Rough	1.0G	25	A-88478-25

Two-star range



Size (mm)	Grit	Rough or Smooth	G.F.Q'ty	Per pkg.	Part No.
355x3x25.4	A36P	Smooth	1.0G	5	D-62088-5

Abrasive cut-off wheel for angle cutter #4112H, 4112HS

For cutting masonry materials, concrete, marble, slate, etc.



Application	Size(mm)	G.F.Q'ty	Per pkg.	Part No.
Brick	305x3.5x25.4	2.0G	25	A-89735

Grinding wheel for Bench grinder



Size	Grit	Part No.
150 x 16 x 12.7	A36M	B-51904 (EN)
150 x 16 x 12.7	GC120H	B-51932 (EN)
150 x 6.4 x 12.7	A60M	A-47195
205 x 19 x 15.88	WA60K	A-47260
205 x 19 x 15.88	GC120H	B-51976 (EN)
205 x 19 x 15.88	WA60	B-51960

Grinding wheel for Straight grinder



Size	Grit	Part No.
125 x 19 x 12.7	24P	741015-5
125 x 19 x 12.7	36P	741016-3

Wheel point

Application:

A: Mild steel, carbon steel, etc.

WA: Hardened and special steels.

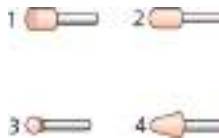

No.	per pkg.	Wheel dia. (mm)	Shank size (mm)	Type	Part No.
-----	----------	-----------------	-----------------	------	----------

For Model:

903, 906, GD0800C, GD0810C, GD0600, DGD800, DGD801

1	10	5	3	A	794050-2
1	10	8	3	A	794052-8
1	10	10	3	A	794053-6
2	10	5	3	WA	794054-4
2	10	6	3	WA	794055-2
2	10	10	3	WA	794057-8
3	10	10	3	A	794059-4

For Model:

906, GD0800C, GD0810C, GD0600, DGD800, DGD801

1	1	19	6	WA	741614-3
1	1	19	1/4"	WA	741617-7
4	1	19	6	WA	741615-1
4	1	19	1/4"	WA	741616-9

ACCESSORIES

Coated Abrasive



Hook & Loop backing



Grit size



Sanding wood



Sanding wood



Sanding wood



Sanding wood, large surfaces



Sanding paint



Sanding paint



Sanding plastic



Removing paint



Removing paint from metal or polishing



Sanding metal



Polishing



Wood, hard and soft



Ceramic

Coated Abrasive

Flap Disc



Backing Type



Fiber glass backing
Standard backing type



Nylon backing
For heavy duty

Shape Type



Flat
Effective for flat surface











Angled
Effective for angles or corners

Material chart

AA : Recommended

A : Acceptable

Description of Grit material	 Aluminum oxide	 Zirconia alumina	 Silicon carbide	 Ceramic aluminum oxide
Description of label color	Best for metal 	Best for INOX and metal 	Best for Masonry 	Best for INOX, metal and non-ferrous metal 
Wood	A			
Plastic	A			
Metal	AA	AA		AA
No ferrous	A	A		AA
INOX		AA		AA
Masonry			AA	

Coated Abrasive

Flap Disc

Industrial Flap Disc for Heavy Duty



Feature

- High efficiency
- Long life
- Suitable for Industry use
High-speed Grinding with high-power grinder.

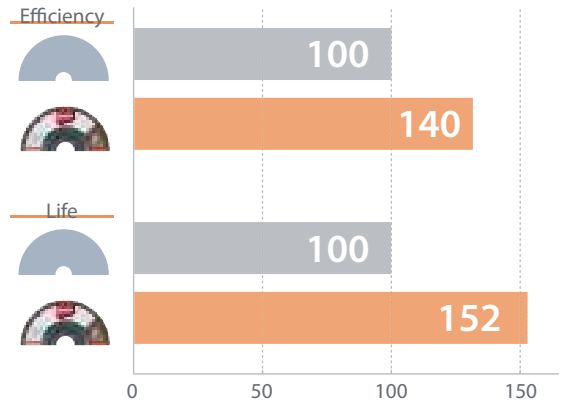

Flexible Flap Disc



Feature

High flexibility

Suitable for grinding on CURVE/EDGE/CORNER surface.



Coated Abrasive

Flexible Flap Disc Material: Aluminum oxide

High flexibility. Suitable for grinding on CURVE/EDGE/CORNER surface.



Application Best



Better



Backing Type	Shape	Dia. (mm)	Hole dia. (mm)	Grit	Part No.
Backing less		100	16	A40	D-62686
			16	A60	D-62692
			16	A80	D-62701
			16	A120	D-62717
			16	A120	D-62717

Flap Disc series Material: Zirconia aluminum



Application Best



Better



Backing Type	Backing Shape	Dia. (mm)	Hole dia. (mm)	Grit	Part No.
Fiber Glass		115	22.23	Z40	D-27436
			22.23	Z60	D-27442
			22.23	Z80	D-27458
			22.23	Z120	D-27464

Material: Aluminum oxide



Application Best



Better



Backing Type	Backing Shape	Dia. (mm)	Hole dia. (mm)	Grit	Part No.
Fiber Glass		125	22.23	A80	D-27109
			22.23	A120	D-27115
		180	22.23	A120	D-27165
Fiber Glass	Angled	115	22.23	A60	D-27246

Flap Disc Economy type Material: Zirconia aluminum

More Economy Type



Application Best



Better



Backing Type	Backing Shape	Dia. (mm)	Hole dia. (mm)	Grit	Part No.		
Fiber Glass		100	16	Z40	D-63703		
			16	Z60	D-63719		
			16	Z80	D-63725		
			16	Z120	D-63731		
		125	22.23	Z40	D-63781		
			22.23	Z60	D-63797		
			22.23	Z80	D-63806		
			22.23	Z120	D-63812		
		180	22.23	Z40	D-63828		
			22.23	Z60	D-63834		
			22.23	Z80	D-63840		
					22.23	Z120	D-63856

Flap Disc Economy type Material: Aluminum oxide



Application Best



Better



Backing Type	Backing Shape	Dia. (mm)	Hole dia. (mm)	Grit	Part No.		
Fiber Glass		100	16	A40	D-63395		
			16	A60	D-63404		
			16	A80	D-63410		
			16	A120	D-63426		
		125	22.23	A40	D-63476		
			22.23	A60	D-63482		
			22.23	A80	D-63498		
			22.23	A120	D-63507		
		180	22.23	A40	D-63513		
			22.23	A60	D-63529		
			22.23	A80	D-63535		
					22.23	A120	D-63541

Coated Abrasive

Strip Disc



Structure

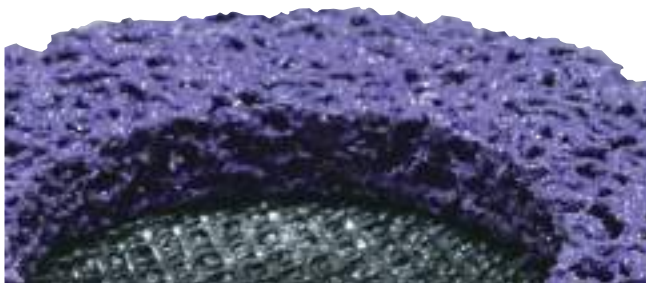

Special tool for stripping work

Grit (SiC)

It is covered with glue with Sic (Silicon Carbide), so it enables you to grind quickly with less power.

Fiber

Entangled fiber acts as a cushion material and prevents from grinding too much and scratching steel.

Features

The surface condition of strip disc is the finest.



Strip disc



Flap Wheel



Grinding Wheel

Application



*Removing Paint



*Removing Rust



*Removing blue weld discoloration

Coated Abrasive

Strip Disc

Removing Paint, Removing Rust, Removing blue weld discoloration





Color	Type	Speed	Life
Black 	Standard	100%	100%
Purple 	Long life	94%	130%

Strip Disc

Application Best



Colour	Backing Type	Dia. (mm)	Hole dia. (mm)	Part No.
Black 	Fiber Glass 	100	16	B-28961
		115	22.23	B-28977
		125	22.23	B-28983
		180	22.23	B-28999

Surface Conditioning Flap Disc series



Backing Type	Backing Shape	Dia. (mm)	Hole dia. (mm)	Grit	Part No.
Fiber Glass 	Angled 	100	16	Coarse	B-40711
			16	Medium	B-40727
			16	Fine	B-40733
			16	Very Fine	B-40749
Fiber Glass 	Flat 	100	16	Coarse	B-40870
			16	Medium	B-40886
			16	Fine	B-40892
			16	Very Fine	B-40901

Fiber sanding disc

Use with backing pad.



*For stone (wet), For Model: PK5001C, PK5011C only

**For Model: GV6010 only

Diameter (mm)	Grit	Per pkg.	Part No.
115	C24	10	794104-5
	C30	10	794105-3
	C50	10	794106-1
	C80	10	794107-9
	C120	10	794108-7
125	A50	5	794319-4
	A80	5	794320-9
	A120	5	794321-7
125	C24	10	794096-8
	C30	10	794097-6
	C50	10	794098-4
	C80	10	794099-2
150	C120	10	794100-3
	**C50	10	794086-1
	**C80	10	794088-7
150	**C120	10	794090-0
	C24	10	794070-6
	C30	10	794071-4
150	C50	10	794072-2
	C80	10	794073-0
	C100	10	794219-8
	C120	10	794074-8
180	C16	10	794091-8
	C20	10	794092-6
	C24	10	794093-4
	C30	10	794218-0
	C50	10	794094-2
	C80	10	794095-0
	C100	10	794220-3
C120	10	794221-1	

Disc dia. (mm)	Grit	Per pkg.	Part No.
----------------	------	----------	----------

Pre-punched (9 hole) for Dry wall
For Model: DSL800

*Additional coat



225	*A40	25	B-68389
	*A80	25	B-68395
	*A120	25	B-68404
	*A150	25	E-02375
	*A180	25	B-68410
	*A220	25	E-02381
	*A320	25	B-68426



Coated Abrasive

Abrasive disc (hook & loop type)



Disc dia. (mm)	Grit	Per pkg.	Part No.
----------------	------	----------	----------

Pre-punched (8 hole) for Paint
For Model:
BO5030, BO5031, BO5040, BO5041
*Additional coat

125	40	10	D-65816
	60	10	D-65822
	80	10	D-65838
	100	10	D-65844
	120	10	D-65850
	150	10	D-65866
	180	10	D-65872
	240	10	D-65888
	320	10	D-65894
400	10	D-65903	

Pre-punched (9 hole) for Paint
For Model:
BO6030, BO6040
*Additional coat

150	*WA40	10	794607-9
	*WA60	10	794608-7
	*WA80	10	794609-5
	*WA120	10	794610-0
	*WA180	10	794611-8
	*WA240	10	794612-6
	*WA400	10	794613-4

Pre-punched (15 hole) for Wood
For Model:
BO6030, BO6040, BO6050

150	A40	10	D-54586
	A60	10	D-54592
	A80	10	D-54601
	A100	10	D-54617
	A120	10	D-54623
	A150	10	D-54639
	A180	10	D-54645
	A240	10	D-54651
	A320	10	D-54667

Abrasive disc (hook & loop type)



Disc dia. (mm)	Grit	Per pkg.	Part No.
----------------	------	----------	----------

125	60	10	D-54140
	80	10	D-54156
	100	10	D-54162
	180	10	D-54190
	40	10	P-43533
	60	10	P-43549
	80	10	P-43555
	100	10	P-43561
	120	10	P-43577
	180	10	P-43583
	240	10	P-43599

For Model: MT922



125	40	10	P-33342
	60	10	P-33358
	80	10	P-33364
	100	10	P-33370
	120	10	P-33386
	180	10	P-33392
240	10	P-33401	

Abrasive belt

Sanding arm Assembly
For Model: 9032

6mm: 125157-7, 9mm: 125158-5, 13mm: 125159-3



Belt Size (mm)	Grit	Per pkg.	Part No.
----------------	------	----------	----------

For Model:
9032

9 x 533	A80	10	A-34469
	A100	10	A-34475
13 x 533	A60	10	A-34578
	A100	10	A-34590

For Model:
9031

30 x 533	AA120	10	A-23896
	40	5	P-36675
	60	5	P-36681
	80	5	P-36697
	100	5	P-36706
	120	5	P-36712
	150	5	P-36728
	240	5	P-36734

For Model:
9902, 9903

76 x 533	WA40	10	794119-2
	WA60	10	794120-7
	WA80	10	794121-5
	WA100	10	794122-3
	WA120	10	794123-1
	WA150	10	794124-9
	WA180	10	794225-3
WA240	10	794125-7	

Coated Abrasive

Belt Size (mm)	Grit	Per pkg.	Part No.
----------------	------	----------	----------

For Model:
9920, 9924DB

76 x 610	WA40	5	P-37312
	WA60	5	P-37328
	WA80	5	P-37334
	WA100	5	P-37340
	WA120	5	P-37356
	WA150	5	P-37362
	WA240	5	P-37378
	WA40	10	794237-6
	WA80	10	794239-2
	WA120	10	794241-5
	WA150	10	794242-3
	WA180	10	794243-1
	WA240	10	794244-9

For Model:
9401, 9402, 9403, 9404

100 x 610	WA40	5	P-36887
	WA60	5	P-36893
	WA80	5	P-36902
	WA100	5	P-36918
	WA120	5	P-36924
	WA150	5	P-36930
	WA240	5	P-36946
	WA40	5	794133-8
	WA60	5	794134-6
	WA80	5	794135-4
	WA100	5	794136-2
	WA120	5	794137-0
	WA150	5	794138-8
	WA180	5	794222-9
	WA240	5	794139-6

Belt Sander

Belt type and application
WA, AA: Wood, iron and steel.
CC: Stone and plastics.



Paper Size (mm)	Grit	Per pkg.	Part No.
-----------------	------	----------	----------

Sanding Belt for LB1200F

20 x 2240	80	5	B-42581
20 x 2240	120	5	B-42597

Finishing Sander / Random Orbit Sander

Abrasive paper



Paper Size (mm)	Grit	Per pkg.	Part No.
-----------------	------	----------	----------

For Model:
BO4556, BO4540



114 x 140	150	10	794214-8
	40	10	P-36398
	60	10	P-32904
	80	10	P-36407
	100	10	P-32910
	120	10	P-32926
	150	10	P-32932
	180	10	P-36413
	240	10	P-36429

For Model:
BO4900, BO4900V, BO4901, 9046

114 x 200	60	10	794210-6
	80	10	794470-0
	100	10	794209-1
	120	10	794212-2
	150	10	794213-0
	180	10	794211-4

Abrasive paper 230mm x 280mm (9" x 11")

How to use



1/2 sheet



BO4900 etc

1/3 sheet

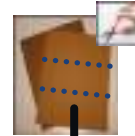

BO3710 etc

1/4 sheet



BO4555 etc

Coated Abrasive

Waterproof Abrasive paper (9" x 11")

One-star range



For Model

All Finishing Sander, Handsanding:

In case of these items are used with power tools, dry use only.

Paper Size (mm)	Grit	Per pkg.	Part No.
230 x 280	1200	50	D-56867

Wool Pad

(hook & loop type)

(For high gloss polishing)



*When use 100mm size wool pad, use suitable pad for PO5000C

Model No.	Disc dia. (mm)	Part No.
PO5000C	100	197918-5
PO5000C	100	D-67000
PO5000C	125	197920-8
BO6050, PO6000C	150	D-65735
DBO180, DBO140, BO503, BO5041	140	794560-9
(Use with Backing pad and Sleeve18)		
9227C/B, 9237C/CB, PV7001/C, PV7000C, SA7000C	180	192629-7

Wool bonnet



Model No.	Size (mm)	Part No.
PV7001C, PV7000C, 9207SPB, 9218PB/L, 9227C/B, SA7000C	180	794176-0

Wool bonnet double side



Model No.	Size (mm)	Type	Part No.
PV7001C, PV7000C, 9227C/B, 9237C/B, SA7000C	230	For Rough finishing	D-56954
PV7001C, PV7000C, 9227C/B, 9237C/B, SA7000C	230	For Bright finishing	D-57146

Adapter for Wool Bonnet Double Side



Model No.	Shank Size	Part No.
PV7001C, PV7000C, 9227C/B, 9237C/B, SA7000C	M14	D-56960
PV7000C, 9227C/B, 9237C/B,	M16	D-57043

Felt Pad

(hook & loop type)

(For removing wax)



*When use 100mm size felt pad, use suitable pad for PO5000C

Model No.	Disc dia. (mm)	Part No.
PO5000C	100	197916-9
DBO180, DBO140, BO5031, BO5041, PO5000C	125	196152-4
BO6030, BO6050, PO6000C	150	193288-0

Sponge pad

(Hook & loop type)

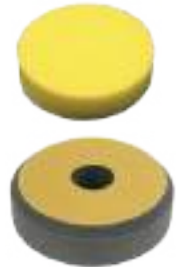

*When use 100mm size sponge, use suitable pad for PO5000C

Model No.	Size (mm)	Part No.
PO5000C	100	197912-7
DBO180, DBO140, BO5031, BO5041, PO5000C	125	794558-6
BO6030, PO6000C, BO6050	150	197914-3

(Use with Backing pad)

9227C/CB, 9237C/CB, PV7001/C, PV7000C	190	193470-1
---------------------------------------	-----	----------

Sponge pad

(Hook & loop type)



Coated Abrasive

Color & Application Coarse

Color: Orange
Use: Suitable for taking small scratches



Middle

Color: Blue
Use: Suitable for finishing



Fine

Color: Black
Use: Suitable for wax coating



Sponge type

Flat
Feature: Full contact surface
Use: Suitable for large, flat, panel



Sponge type

Wave
Feature: Air flow between the pad and the paint.
Use: Suitable for bumper made with resin.



For Model:
PO5000C, PO6000C

*When use 100mm size sponge, use suitable pad for PO5000C

Type	Size	Application	Part No.
Flat	100mm	Coarse (Orange)	D-62505
		Middle (Blue)	D-62533
		Fine (Black)	D-62561
	125mm	Coarse (Orange)	D-62511
		Middle (Blue)	D-62549
		Fine (Black)	D-62577
	150mm	Coarse (Orange)	D-62527
		Middle (Blue)	D-62555
		Fine (Black)	D-62583
Wave	100mm	Coarse (Orange)	D-62599
		Middle (Blue)	D-62620
		Fine (Black)	D-62658
	125mm	Coarse (Orange)	D-62608
		Middle (Blue)	D-62636
		Fine (Black)	D-62664
	150mm	Coarse (Orange)	D-62614
		Middle (Blue)	D-62642
		Fine (Black)	D-62670

Rubber pad

Use with pre-punched abrasive disc.



Model No.	Size	Type	Part No.
BO6050	150mm	Hard (For coarse sanding)	197315-5
	150mm	Soft (For general sanding)	197314-7
	150mm	Super Sof (For fine sanding)	197316-3
	130mm	Hard (For polishing)	197317-1
BO5030, BO5031, BO5040, BO5041	123mm	-	743081-8
PO5000C, PO6000C	100mm	-	197926-6
	125mm	-	197923-2
	150mm	-	197929-0

Backing pad

(Hook & loop type)
(Use with Wool pad and Sleeve18 or Sponge pad)



Model No.	Spindle thread	Part No.
9227C/B, PV7001/C, PV7000C, SA7000C	M14 x 2 (DIN)	743053-3
	M16	743054-1

100mm Diamond polishing pad

(Hook & loop type)
8 pads assortment (1 each) D-15805



For Model:
PW5000C, PW5001C

Color	Grit	Part No.
Blue	50	D-15584
Yellow	100	D-15590
Orange	200	D-15609
Red	400	D-15615
Dark green	800	D-15621
Light green	1500	D-15637
Brown	3000	D-15643
Green	Buff (Finishing)	D-15659

ACCESSORIES

Multi Tool



Tungsten carbide grit, #30



Tungsten carbide grit, #30



Diamond grit, #40



Serrated edge



Sharp blade



Sharp blade



Delta plate



Sanding plate



Pointed teeth



Japan teeth

Sawing

For Model:
DTM51, DTM50, DTM41, DTM40, TM3010C, TM3000C
Size: W= width (mm), L=length (mm)



Segment saw blade 85

TMA045



Application/ Recommended Use
Wood&Metal/ Suitable for flush cutting
Cut-off door frame to length on the floor
Cut-out parquet/laminate flooring
Cut-off smaller mouldings to length

Diameter (mm)	Type	Per pkg.	Part No.
85	BiM, Wood&Metal	1	B-64799

Segment saw blade 100

TMA046



Application/ Recommended Use
Wood&Metal/ Suitable for deep cutting
Cut-off door frame to length on the floor
Cut-out parquet/laminate flooring
Cut-off smaller mouldings to length

Diameter (mm)	Type	Per pkg.	Part No.
100	BiM, Wood&Metal	1	B-64808

Segment saw blade 85

TMA049



Application/ Recommended Use
Wood/ Suitable for flush cutting
Plunge-cut in solid wood
Cut-off plastic pipe(PVC) to length

Diameter (mm)	Type	Per pkg.	Part No.
85	HCS, Wood	1	B-64836

Segment saw blade 85

TMA064



Application/ Recommended Use
Non-ferrous metal, FRP, PVC / Suitable for corners.
Plunge cut in plasterboard or cement-bonded fiber boards
Cut-off smaller mouldings to length
Cutting recesses in epoxy/glass fiber reinforced plastic

Diameter (mm)	Type	Per pkg.	Part No.
85	BiM-TiN, Multi Material	1	B-64973

Plung-cutting saw blades

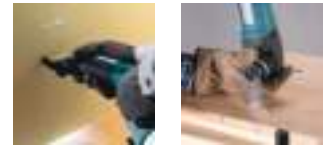

Bow Shape plunge cut saw blade 32

TMA047



Application/ Recommended Use
Wood and Metal / Suitable for Precisely plunge cut
Plunge cut in hardwood

Size (mm)	Type	Per pkg.	Part No.
32 x 50	BiM, Wood&Metal	1	B-64814

Bow Shape plunge cut saw blade 65

TMA048



Application/ Recommended Use
Wood and nails/ Suitable for plunge cutting
Cutting wood with nails
Cutting a door frame to length
Plunge cuts in laminated panels.

Size (mm)	Type	Per pkg.	Part No.
65 x 40	BiM, Wood&Metal	1	B-64820

Plunge cut saw blade 24

TMA050



Application/ Recommended Use
Wood, Plunge-cut in softwood
Cutting a recess in furniture components
Flush cutting wooden components to length

Size (mm)	Type	Per pkg.	Part No.
24 x 50	HCS, Wood	1	B-64842

Bow Shape plunge cut saw blade 32

TMA051



Application/ Recommended Use
Wood/ Suitable for Precisely plunge cut
Cutting a recess in furniture components
Plunge-cut in softwood

Size (mm)	Type	Per pkg.	Part No.
32 x 50	HCS, Wood	1	B-64858

Multi Tool

Bow Shape plunge cut saw blade 65

TMA052



Application/ Recommended Use
Wood/ Suitable for plunge cutting
Flush cutting wooden components

Size (mm)	Type	Per pkg.	Part No.
65 x 40	HCS, Wood	1	B-64864

Bow Shape plunge cut saw blade 65

TMA056



Application/ Recommended Use
Wood/ Suitable for plunge cutting
Cutting a recess in furniture components
Flush cutting wooden components

Size (mm)	Type	Per pkg.	Part No.
65 x 40	HCS, Wood	1	B-64901

Bow Shape plunge cut saw blade 32

TMA053



Application/ Recommended Use
Hard Wood/ Suitable for Precisely plunge cut
Plunge cut in hardwood
Cutting a recess in furniture components
Plunge cut in laminate panels

Size (mm)	Type	Per pkg.	Part No.
32 x 50	BiM, Wood	1	B-64870

Plunge cut saw blade 10

TMA057



Application/ Recommended Use
Metal/ Suitable for flush cutting in nails or plasterboard
Filigree adjustment work on non-ferrous profiles
Plunge cuts in plasterboard

Size (mm)	Type	Per pkg.	Part No.
10 x 30	BiM, Metal	1	B-64917

Bow Shape plunge cut saw blade 32

TMA054



Application/ Recommended Use
Wood/ Suitable for Precisely plunge cut
Cutting a recess in furniture components

Size (mm)	Type	Per pkg.	Part No.
32 x 50	HCS, Wood	1	B-64886

Plunge cut saw blade 20

TMA058



Application/ Recommended Use
Metal/ Suitable for flush cutting in nails or copper pipe
Plunge cuts in plasterboard

Size (mm)	Type	Per pkg.	Part No.
20 x 30	BiM, Metal	1	B-64923

Bow Shape plunge cut saw blade 65

TMA055



Application/ Recommended Use
Hard Wood/ Suitable for plunge cutting
Plunge cutting in laminated panels or hard wood
Cutting a recess in furniture components
Flush cutting wooden components

Size (mm)	Type	Per pkg.	Part No.
65 x 40	BiM, Wood	1	B-64892

Plunge cut saw blade 32

TMA059



Application/ Recommended Use
Metal/ Suitable for flush cutting in nails or copper pipe
Plunge cuts in plasterboard

Size (mm)	Type	Per pkg.	Part No.
32 x 50	BiM, Metal	1	B-64939

Multi Tool

TC Bar plunge cut saw blade 20

TMA060



Application/ Recommended Use
Metal/ Suitable for flush cutting in hardened screws and nails
Cutting stainless steel
Cutting fiberglass

Size (mm)	Type	Per pkg.	Part No.
20 x 40	TC/HM, Metal	1	B-64945

TC Bar plunge cut saw blade 32

TMA061



Application/ Recommended Use
Metal/ Suitable for flush cutting in hardened screws and nails
Cutting stainless steel
Cutting fiberglass

Size (mm)	Type	Per pkg.	Part No.
32 x 40	TC/HM, Metal	1	B-64951

Scraping



Scraper 52 Rigid

TMA065



Application/ Recommended Use
Removing mortar or tile adhesive
Removing mortar and concrete residues
Removing hard, brittle carpet adhesive residues

Size (mm)	Type	Per pkg.	Part No.
52 x 26	HCS	1	B-64989

Scraper 52 Flexible

TMA066



Application/ Recommended Use
Removing soft carpet adhesive residues
Removing paint residues
Removing silicone joints

Size (mm)	Type	Per pkg.	Part No.
52 x 40	HCS	1	B-64995

Cutting



Serrated Seg Blade 100

TMA063



Application/ Recommended Use
Polystyrene, Rubber/ Suitable for insulation material
Flush cutting to length of protruding insulation material, especially polystyrene
Cut-out insulation panels to size
Cut soft materials (cardboard, carpet, leather...)

Diameter (mm)	Type	Per pkg.	Part No.
100	BiM	1	B-64967

General Joint Cutter

TMA067



Application/ Recommended Use
Cutting soft expansion joints
Cutting window putty
Cutting insulation materials

Size (mm)	Type	Per pkg.	Part No.
28 x 40	HCS	1	B-65006

Universal purpose knife

TMA068



Application/ Recommended Use
Cutting insulation materials
Cutting window putty.
Cutting expansion joints

Size (mm)	Type	Per pkg.	Part No.
11 x 24	HCS	1	B-65012

Routing and Rasing



Multi Tool

TC Remover

TMA074



Application/ Recommended Use
Routing joints on wall and floor tiles
Removing mortar or tile adhesive
Removing joints in the smallest of corners with the tungsten carbide tip

Size (mm)	Type	Per pkg.	Part No.
70	TC/HM grit #40	1	B-65078

TC Seg Saw Blade 85

TMA069



Application/ Recommended Use
Routing joints on wall and floor tiles
Smaller cutouts in soft wall tiles
Routing grooves in porous concrete, for laying concealed cables and pipes

Diameter (mm)	Type	Per pkg.	Part No.
85	TC/HM grit #30	1	B-65028

TC Plunge Blade 32

TMA075



Application/ Recommended Use
Plunge cut and rasping in fiberglass
Deburr cut-out in fiberglass
Remove grouts in narrow corners or tide spaces

Size (mm)	Type	Per pkg.	Part No.
32 x 30	TC/HM grit #50	1	B-65084

TC Seg Saw Blade 70

TMA071



Application/ Recommended Use
Routing extra-thin 1/16" joints on wall tiles
Routing recesses in epoxy/glass fiber reinforced plastic
Routing grooves in porous concrete, for laying concealed cables and pipes

Diameter (mm)	Type	Per pkg.	Part No.
70	TC/HM grit #50	1	B-65040

TC Sanding Pointer 32

TMA076



Application/ Recommended Use
Sanding paint in tight gap
Sanding parquet varnish in hard-to-reach areas
Sanding wood, wood-plastic composite and epoxy

Size (mm)	Type	Per pkg.	Part No.
32 x 50	TC/HM grit #40	1	B-65090

TC Seg Saw Blade 85

TMA072



Application/ Recommended Use
Routing joints on floor and wall tiles
Routing smaller cut outs in soft wall tiles
Routing grooves in porous concrete

Diameter (mm)	Type	Per pkg.	Part No.
85	TC/HM grit #40	1	B-65056

TC Sanding Pointer 32

TMA077



Application/ Recommended Use
Sanding paint in tight gap
Sanding parquet varnish in hard-to-reach areas
Sanding wood, wood-plastic composite and epoxy

Diameter (mm)	Type	Per pkg.	Part No.
32 x 50	TC/HM grit #100	1	B-65109

TC Bar plunge cut saw blade 45

TMA079



Application/ Recommended Use
Metal/ Suitable for flush cutting in hardened screws and nails
Cutting stainless, aluminum, fiberglass, plasterboard

Size (mm)	Type	Per pkg.	Part No.
45 x 40	TC/HM, Metal	1	B-69755

Multi Tool

TC Bar Bow Shape plunge cut saw blade 32

TMA080



Application/ Recommended Use
Multi material/ Suitable for precisely plunge cut
Plunge cut plasterboard, fiberglass, epoxy, aluminum, stainless

Size (mm)	Type	Per pkg.	Part No.
32 x 40	TC/HM, Multi Material	1	B-69761

Bow Shape plunge cut saw blade 53

TMA081



Application/ Recommended Use
Multi material/ Suitable for precisely and fast plunge cut in plasterboard
1 Blade does the job of 2 (Plunge & Cut on). Cutting plasterboard, wood, epoxy

Size (mm)	Type	Per pkg.	Part No.
53 x 40	BiM, Multi Material	1	B-69777

Universal purpose knife

TMA082



Application/ Recommended Use
Cutting teaksealant, caulking material

Size (mm)	Type	Per pkg.	Part No.
12 x 29	Stainless	1	B-69783

TC Sanding Plate 90

TMA083



Application/ Recommended Use
Removing mortar, tile adhesive, paint on fiberglass
Removing carpet adhesive residues from a mineral surface

Size (mm)	Type	Per pkg.	Part No.
90	TC/HM grit #20	1	B-69799

TC Sanding Plate 90

TMA084



Application/ Recommended Use
Sanding in wood with paint, paint of fiberglass
Removing mortar, tile adhesive, carpet adhesive residues from a mineral surface

Size (mm)	Type	Per pkg.	Part No.
90	TC/HM grit #40	1	B-69808

TC Sanding Plate 90

TMA085



Application/ Recommended Use
Sanding in wood, wood with paint roughly

Size (mm)	Type	Per pkg.	Part No.
90	TC/HM grit #60	1	B-69814

TC Sanding Plate 90

TMA086



Application/ Recommended Use
Sanding in wood for fine surfaces

Size (mm)	Type	Per pkg.	Part No.
90	TC/HM grit #100	1	B-69820

Diamond Seg Saw blade



Diamond Seg Saw blade 85

TMA070



Application/ Recommended Use
Cutout of soft wall tiles and FRP
Routing recesses in epoxy/glass fiber reinforced plastic
Routing joints on wall tiles

Diameter (mm)	Type	Per pkg.	Part No.
85	Diamond grit #40	1	B-65034

Riff sanding



Multi Tool

TC Sanding Plate 78

TMA073



Application/ Recommended Use
 Removing mortar or tile adhesive
 Removing carpet adhesive residues from a mineral surface

Size (mm)	Type	Per pkg.	Part No.
78	Diamond grit #20	1	B-65062

Sanding pad

TMA078



Size (mm)	Type	Per pkg.	Part No.
93	hook & loop	1	B-65115

Multi tool Starlock blade sets

Tile Set

TMA058 Plunge cut saw blade 20
 TMA065 Scraper 52 rigid
 TMA069 HM Seg saw blade 85
 TMA073 HM Sanding plate 78

Part No.

B-67496



Floor Set

TMA045 Segment saw blade 85
 TMA048 Plunge cut saw blade 65
 TMA051 Plunge cut saw blade 32
 TMA066 Scraper 52 Flexible

Part No.

B-67505



Plunge Cut Set

TMA045 Segment saw blade 85
 TMA047 Plunge cut saw blade 32
 TMA053 Bow plunge cut saw blade 32
 TMA058 Plunge cut saw blade 20

Part No.

B-67480



Carpentry Set

TMA045 Segment saw blade 85
 TMA047 Plunge cut saw blade 32
 TMA053 Bow plunge cut saw blade 32
 Sanding Pad x 2pcs

Part No.

B-67511



Carpentry Set

TMA006 Segment saw blade 85
 TMA009 Plunge cut saw blade 28
 TMA010 Plung cut saw blade 32
 Sanding Pad x 2pcs

Part No.

B-30639



Abrasive delta paper

Use with Sanding pad (B-46202)
 (hook & loop type)

Wood / long-life



Suitable for sanding wood, hardwood, chipboard, construction boards and metal

Paper Size (mm)	Grit	Per pkg.	Part No.
94	60	10	B-21565
94	80	10	B-21571
94	100	10	B-21587
94	120	10	B-21593
94	180	10	B-21602
94	240	10	B-22931
94	60,80,100, 120,180	10 (2pcs/each)	B-21559

Multi Tool

Wood



Suitable for sanding wood and wooden materials

Paper Size (mm)	Grit	Per pkg.	Part No.
94	60	10	B-21624
94	80	10	B-21630
94	100	10	B-22947
94	120	10	B-21646
94	150	10	B-22953
94	180	10	B-21652
94	240	10	B-21668
94	60,80,120, 180,240	10 (2pcs/each)	B-21618

Paint



Suitable for sanding paint, varnish or roughcast

Paper Size (mm)	Grit	Per pkg.	Part No.
94	60	10	B-21680
94	80	10	B-21696
94	100	10	B-21705
94	120	10	B-22969
94	240	10	B-21711
94	320	10	B-21727
94	60,80,100, 240,320	10 (2pcs/each)	B-21674

Stone



Suitable for coarse to gloss sanding of extremely hard materials such as stone or glass

Paper Size (mm)	Grit	Per pkg.	Part No.
94	120	10	B-21749
94	240	10	B-21755
94	400	10	B-21761
94	600	10	B-21777
94	1200	10	B-21783
94	120,240,400, 600,1200	10 (2pcs/each)	B-21733

Fleece



Suitable for removing the rust of metal and the dirt of wood

Paper Size (mm)	Grit	Per pkg.	Part No.
94	Coarse / 100	1	B-21808
94	Medium / 280	1	B-21799
94	without grit	1	B-21814

Polishing felt



Suitable for pre-polishing very dirty or scratched surfaces

Paper Size (mm)	Grit	Per pkg.	Part No.
94	Hard	1	B-21820

Economy type

Wood



Suitable for sanding wood, wooden materials and metal

Paper Size (mm)	Grit	Per pkg.	Part No.
94	40	10	D-58578
94	60	10	D-58584
94	80	10	D-58590
94	100	10	D-58609
94	120	10	D-58615
94	150	10	D-58621
94	180	10	D-58637
94	240	10	D-58643
94	320	10	D-58659

Multi Tool

Multi tool papers applications

Rating Suitability for application:

AA = Especially Suitable

A = Suitable

n.r = No Rating



Product Application and Rating On Each Material		Grit	Paint	Varnish	Filler	Roughcast	Wood / Wooden materials	soft wood	hard wood	Plywood	Chipboard/MDF	Metal	Steel (mild steel / carbon steel)	Stone	Marble	Granite	Glass	Perspex	Corian®	Glass fiber reinforced plastics	
Wood / long-life	Coarse	60	n.r	n.r	n.r	n.r	AA	AA	AA	AA	AA	AA	A	n.r	n.r	n.r	n.r	n.r	n.r	n.r	n.r
		80																			
	Medium	100																			
		120																			
	Fine	180																			
Wood	Coarse	60	n.r	n.r	n.r	n.r	AA	A	AA	AA	AA	n.r	n.r	n.r	n.r	n.r	n.r	n.r	n.r	n.r	n.r
		80																			
	Medium	100																			
		120																			
	Fine	150																			
180																					
Paint	Coarse	60	AA	AA	AA	AA	n.r	n.r	A	n.r	n.r	A	A	n.r	n.r	n.r	n.r	n.r	n.r	n.r	n.r
		80																			
	Medium	100																			
		120																			
	Fine	240																			
320																					
Stone	Medium	120	A	AA	n.r	n.r	n.r	n.r	n.r	n.r	n.r	n.r	n.r	A	A	A	A	A	A	A	A
		240																			
	Fine	400																			
		600																			
	Very fine	1200																			

Economy type

Wood	Coarse	40	A	A	n.r	n.r	AA	AA	AA	AA	A	A	A	n.r	n.r	n.r	n.r	n.r	n.r	n.r	n.r
		60																			
		80																			
	Medium	100																			
		120																			
		150																			
	Fine	180																			
		240																			
		320																			

ACCESSORIES

▣ Diamond



Thread / Dia



Dia / Bore



Max speed



Wet



Dry



Not permitted for face grinding

Diamond

Diamond Wheels



Segmented Type:

Most commonly used. Blade has slits and layers of diamond are sintered on edges. Cut faster than continuous rim type and attain average cutting surface.



Segmented Type Laser Welded:

Layer of diamond and plate are welded by laser beam over 1000° C. Ideal with high power machine, thanks to strong bonding by alloying layer of diamond and plate.

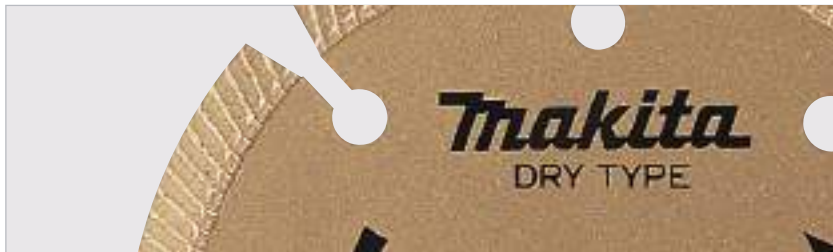

Segmented Wave Type:

This wheel has slits like segmented wheel. Each segment has many notches (Wave). These notches assure;

- Fast cutting with less resistance.
- Smooth debris removal.
- Less loading on wheel.



Corrugated Type:

This wheel has notches around the Rim. Has a characteristic between Continuous Rim and Segmented Type. Has faster cutting like Segmented Type. At the same time, can attain cleaner surface like continuous rim without broken edges.



Continuous Rim Type:

Has layer of diamond with uniform thickness around the entire rim. Can attain clean surface even on crusty, brittle materials. Cut with accuracy but not as fast as segment type wheel.



Electrodeposited Type:

Diamonds are electrodeposited and has more exposure than bonded type. Cuts faster and more efficient.

Diamond

Diamond Wheel

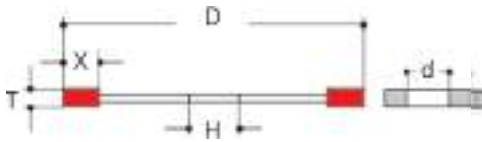

(EN) : EN13236

*These items are available on request. Contact us for the minimum order quantity.

AA: Specially suitable, A: Suitable

Ring

(10 pcs./set)
(mm)

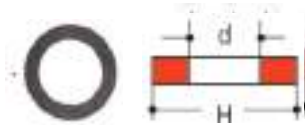

Description	(H)Outer Dia	(D)Hole Dia	Part No.
Ring 20	22.23	20	A-85248
Ring 16	20	16	A-86860



Material

Material No. 1						
Hard concrete	Granite	Gneiss	Smoothable Engineering	Carbonaceous Shale	Sidewalk Slate	Engineering Block/ Engineering Block Class 2
Material No. 2			Material No. 3			
Concrete	Block	U-shaped Groove	Sidewalk Block	Cemented Tile	Marble	Unglazed Tile
Material No. 4		Material No. 5		Material No. 6	Material No. 7	
Brick	Aggregate Block	French Tile	Asphalt	Tile	Glass	

Diamond

Diamond wheel of ideal for Cordless tools



Thin Diamond wheel for Tile

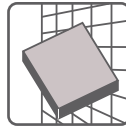

Feature

1. Ideal for cordless tools

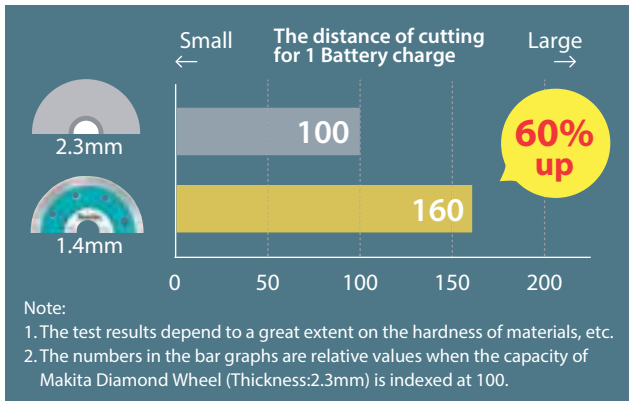

2. Thinner blade

With the bare necessities of thickness which able to have enough strength, able to get smooth and light cutting.



Thin Diamond Wheel for Concrete, Stone



Feature

1. Ideal for cordless tools

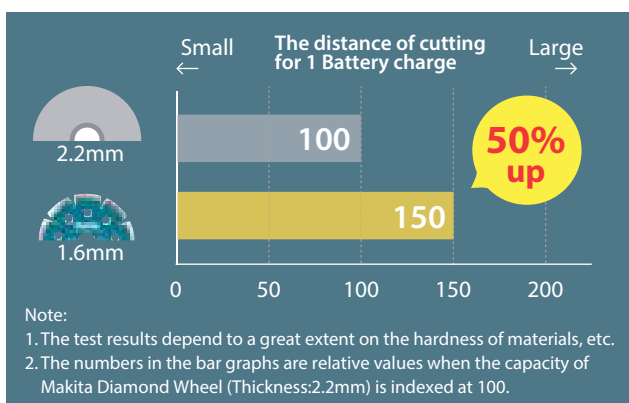

2. Thin blade & Light weight



This blade is designed as 1.6mm (the basis is 1.1mm). So smooth and light cutting is available.

It was lightened by punching the body. (eg:φ125mm blade is 95g [current blade : 125g])
It is also reduced the load on the battery and increased the cutting distance per 1 battery charge.

Diamond

General region Diamond Wheel for Concrete



Segmented

Four-star range



<Ideal for Concrete, Granite / Dry>

Shape	D	T	X	H	d	Color	For Material							Model No.	Part No.
							1	2	3	4	5	6	7		
	115	1.6	7	22.23	-	Blue	AA	AA	AA	A				115mm Grinder	B-53780(EN)
	125	1.6	7	22.23	-	Blue	AA	AA	AA	A				125mm Grinder	B-53796(EN)

Three-star range



<Ideal for Concrete / Dry>

Shape	D	T	X	H	d	Color	For Material							Model No.	Part No.
							1	2	3	4	5	6	7		
	110	1.8	6	20	-	Gold		AA	AA	A	A			110mm Cutter	A-05022

Two-star range



<Ideal for Concrete / Dry>
EN standard conformity

Shape	D	T	X	H	d	Color	For Material							Model No.	Part No.
							1	2	3	4	5	6	7		
	105	1.7	7	20	16	Gold		AA	AA	A	A			100mm Grinder, 110mm Cutter	A-83646
	180	2	7	25.4	22.23	Gold		AA	A	A	A			180mm Grinder, 180mm Cutter	A-87909
	180	2.3	7	25.4	22.23	Gold		AA	AA	A	A			180mm Grinder, 180mm Cutter	A-84121(EN)

Two-star range



<Ideal for Concrete / Dry>
Long life

Shape	D	T	X	H	d	Color	For Material							Model No.	Part No.
							1	2	3	4	5	6	7		
	105	2	7	20	16	Gold		AA	AA	A	A			100mm Grinder, 110mm Cutter	D-05197
	125	2.2	7	20	-	Gold		AA	AA	A				125mm Cutter	D-38261

One-star range



<Ideal for Concrete / Dry >

Shape	D	T	X	H	d	Color	For Material							Model No.	Part No.
							1	2	3	4	5	6	7		
	105	2	7	20	16	Gold	A	AA	A	A				100mm Grinder, 110mm Cutter	D-42531

Diamond

Corrugated

Two-star range



<Ideal for Concrete / Dry>

EN standard conformity

Shape	D	T	X	H	d	Color	For Material							Model No.	Part No.	
							1	2	3	4	5	6	7			
	180	2.3	7	25.4	22.23	Gold		AA	AA	A	A				180mm Grinder, 180mm Cutter	A-84165(EN)

Two-star range



<Ideal for Concrete / Dry >

Long life

Shape	D	T	X	H	d	Color	For Material							Model No.	Part No.	
							1	2	3	4	5	6	7			
	105	2	7	20	16	Gold		AA	AA	A					100mm Grinder, 110mm Cutter	D-05206

Segmented wave

Three-star range



<Ideal for Concrete / Dry>

Shape	D	T	X	H	d	Color	For Material							Model No.	Part No.	
							1	2	3	4	5	6	7			
	125	2	7.5	22.23	-	Blue		AA	AA	A	A				125mm Grinder	A-80438(EN)

Diamond

Continuous rim

Three-star range

★★★

<Ideal for Concrete & Brick / Dry >

Shape	D	T	X	H	d	Color	For Material							Model No.	Part No.
							1	2	3	4	5	6	7		
	80	1.6	3.5	20	-	Gold	AA	AA	AA	AA		AA		4103KB	792192-6

Three-star range

★★★

<Ideal for Concrete & Brick / Wet >

Shape	D	T	X	H	d	Color	For Material							Model No.	Part No.
							1	2	3	4	5	6	7		
	110	1.6	5	20	-	Gold		AA	AA	A		A		110mm Cutter	D-05212
	110	1.5	4	20	-	Gold	A	AA	AA	A	A	AA		110mm Cutter	A-07185
	180	1.85	4	25	-	Gold	A	AA	AA	A	A	AA		180mm Cutter	A-80117

Diamond Wheel for Stone



Segmented

Three-star range

★★★

<Ideal for Granite / Dry >

Shape	D	T	X	H	d	Color	For Material							Model No.	Part No.
							1	2	3	4	5	6	7		
	125	2	7.5	20	-	Gold	AA	AA	AA	AA	A			4105KB	792282-5

Two-star range

★★

<Ideal for Granite / Dry >

Shape	D	T	X	H	d	Color	For Material							Model No.	Part No.
							1	2	3	4	5	6	7		
	105	1.7	7	20	16	Silver	AA	AA	AA	A	A			100mm Grinder, 110mm Cutter	A-84090
	180	2	6	25.4	22.23	Silver	AA	AA	AA	A	A			180mm Grinder, 180mm Cutter	A-84028

Three-star range

★★★

<Ideal for Granite / Dry >

EN standard conformity

Shape	D	T	X	H	d	Color	For Material							Model No.	Part No.
							1	2	3	4	5	6	7		
	180	2	7	22.23	A	Blue	AA	AA	AA	A	A			180mm Grinder	A-80709

Diamond

Two-star range



<Ideal for Granite / Dry>
EN standard conformity

Shape	D	T	X	H	d	Color	For Material							Model No.	Part No.
							1	2	3	4	5	6	7		
	105	2	7	20	16	Silver	AA	AA	AA	A	A			100mm Grinder, 110mm Cutter	A-84040(EN)

One-star range



<Ideal for Granite,Marble / Dry>

Shape	D	T	X	H	d	Color	For Material							Model No.	Part No.
							1	2	3	4	5	6	7		
	105	2.2	7	20	16	Silver	AA	A	AA	A			100mm Grinder, 110mm Cutter	D-42553	

Segmented

Three-star range



<Concrete & Granite / Dry>

Shape	D	T	X	H	d	Color	For Material							Model No.	Part No.
							1	2	3	4	5	6	7		
	180	2.2	8	22.23	-	Gold	AA	AA	AA	A	A			180mm Grinder	B-02060

One-star range



<Ideal for Concrete,Granite/ Dry>

Shape	D	T	X	H	d	Color	For Material							Model No.	Part No.
							1	2	3	4	5	6	7		
	115	2	7	22.23	-	Blue	AA	AA	A	A			115mm Grinder	D-41420	
	180	2.6	7	22.23	-	Blue	AA	AA	A	A			180mm Grinder	D-44339	
	230	2.8	7	22.23	-	Blue	AA	AA	A	A			230mm Grinder	D-44345	

Diamond

Diamond Wheel for Tile



Corrugated

Four-star range



<Ideal for Porcelain Tile / Dry>
Thin type

Shape	D	T	X	H	d	Color	For Material							Model No.	Part No.	
							1	2	3	4	5	6	7			
	105	1.4	10	22.23	16	Blue		A	A	AA			AA		100mm Grinder	B-49030(EN)

Continuous rim

Three-star range



<Wet>

Shape	D	T	X	H	d	Color	For Material							Model No.	Part No.
							1	2	3	4	5	6	7		
	180	1.85	4	25	-	Gold	AA	AA	AA	AA	A	AA		180mm Cutter	792191-8

Three-star range



<Wet>

Shape	D	T	X	H	d	Color	For Material							Model No.	Part No.
							1	2	3	4	5	6	7		
	110	1.5	4	20	-	Gold	A	AA	AA	A	A	AA		110mm Cutter	A-81131

Diamond Wheel for Glass



Corrugated

Three-star range



<Ideal for Bulletproof Glass / Wet>

Shape	D	T	X	H	d	Color	For Material							Model No.	Part No.
							1	2	3	4	5	6	7		
	110	1.2	6	20	-	Blue			AA	A	A	AA	AA	110mm Cutter	B-00795

Diamond

Specialized / Vacuum brazed Diamond Wheel

for Metal



Shape	D	T	X	H	d	Color	For Material							Model No.	Part No.
							1	2	3	4	5	6	7		
	100	1.3	1.5	16	-	Violet	-	-	-	-	-	-	-	100mm Grinder	B-53671(EN)
	125	1.3	1.5	22.23	-	Violet	-	-	-	-	-	-	125mm Grinder	B-53693(EN)	
	180	1.3	1.5	22.23	-	Violet	-	-	-	-	-	-	180mm Grinder	B-53702(EN)	

Specialized / Vacuum brazed Rescue Diamond Wheel

Multi cut

Shape	D	T	X	H	d	Color	For Material							Model No.	Part No.
							1	2	3	4	5	6	7		
	110	2	5	20	16	violet	A	A	A	A				100mm Grinder, 110mm Cutter	D-44426
	125	2.8	4	22.23	-	Red	A	A	A	A	A	A	A	125mm Grinder	B-55310(EN)
	185	3.2	5.0	22.23	-	Violet	A	A	A	A				185mm Grinder	D-58899
	230	3.1	4	22.23	-	Red	A	A	A	A	A	A	A	230mm Grinder	B-55326(EN)
	300	3.4	4.0	25.4	20	Red	A	A	A	A	A	A	A	305mm Power Cutter	B-55332(EN)
	350	3.4	4.0	25.4	20	Red	A	A	A	A	A	A	A	355mm Power Cutter	B-55348(EN)

Specialized / Cordless Tools



Application	D	T	X	H	d	Color	For Material							Model No.	Part No.
							1	2	3	4	5	6	7		
High Grade / Continuous rim / Wet	80	0.8	4	15	-	Silver						AA	AA	4190DW, 4191DW	792296-4
Standard / Continuous rim / Glass / Wet	85	0.9	4	15	-	Silver			A	A		A	A	CC300D, 4190DW, 4191DW	A-01323

Specialized / Engine Power Cutter Tools

Laser Welded



Application	D	T	X	H	d	Color	For Material							Model No.	Part No.
							1	2	3	4	5	6	7		
High Grade / Segmented / Hard Concrete	300	2.8	7	25.4	20	Gold	AA	AA	AA	AA	A			305mm Power Cutter	A-87018
Standard / Segmented / General	300	2.8	5	25.4	20	Silver	A	AA	AA	AA				305mm Power Cutter	A-86773
Standard / Segmented / General	350	3.2	5	25.4	20	Silver	A	AA	AA	AA				355mm Power Cutter	A-87317

Diamond

Specialized / 305mm Cutter, Engine Power Cutter Tools



Application	D	T	X	H	d	Color	For Material							Model No.	Part No.	
							1	2	3	4	5	6	7			
Standard / Segemented / Concrete / Dry	305	3	7.5	30	20, 22.23, 25.4 (Ring size)	Gold	AA	AA	A	A					305mm Cutter, Power Cutter	A-02478
Standard / Segmented / Asphalt / Dry	305	3	7.5	30		Silver				A					305mm Cutter, Power Cutter	A-02484
Standard / Segmented / Concrete & Asphalt / Dry	305	3	7.5	30		Blue	AA	AA	AA	A					305mm Cutter, Power Cutter	A-02490

Specialized / Engine Power Cutter Tools

Segmented



<Laser Welded>

Shape	D	T	X	H	d	Color	For Material							For Model	Part No.
							1	2	3	4	5	6	7		
	300	2.8	7.5	25.4	20	Gold	A	AA	A	AA				305mm Power Cutter	D-56982(EN)
	350	2.8	7.5	25.4	20	Gold	A	AA	A	AA				355mm Power Cutter	D-56998(EN)
	400	3	7.5	25.4	20	Gold	A	AA	A	AA				405mm Power Cutter	D-57009(EN)

Five-star range ★★★★★



Premium universal application 3D Grid diamond blade for professional performance

Available with Stealth technology giving ultimate vibration and noise dampening for the best feel or with a reinforced centre and cooling holes for a fast and comfortable cut. Laser welded, wet and dry use.

AA: Specially suitable, A: Suitable

D	T	X	H	d	Color	For Material							For Model	Part No.
						1	2	3	4	5	6	7		
400	3	12	25.4	20	Red	AA	AA	AA	AA	AA			3DDG / Stealth	*B-13471 (EN)

Specialized / 355mm Portable Cut-off Tools



Application	D	T	X	H	d	Color	For Material							Model No.	Part No.
							1	2	3	4	5	6	7		
Vacuum brazed / Metal	355	3.3	4	25.4	-	violet								355mm Portable Cut-off	D-41414

Specialized / Wall Chaser Tools



Application	D	T	X	H	d	Color	For Material							Model No.	Part No.
							1	2	3	4	5	6	7		
Segmented / Dry	125	2	7.5	22.23	-	Blue	AA	AA	A	A				SG1251	A-80438(EN)
Segmented / Dry	155	2	7	22.23	-	Blue	AA	AA	A	A				SG150	A-83836

Diamond

Low Vibration Offset Diamond Wheel

Low Vibration

The vibration is not conducted to the worker's hand and able to ease the load a lot!!

Less Tapping

Clinging to the material and able to cut smoothly, faster and more efficient.



Low Vibration Type

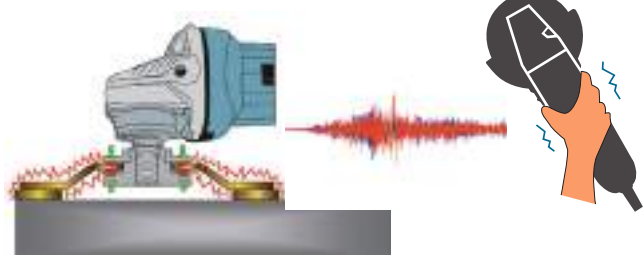

Normal

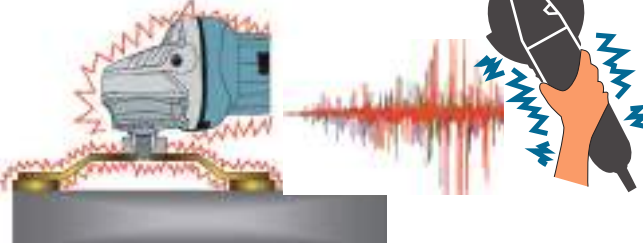

Low Vibration Type



Normal

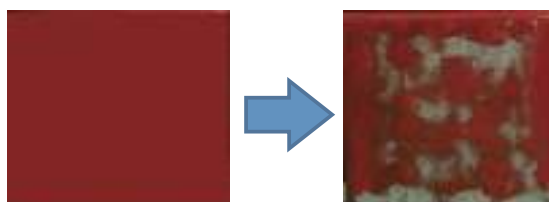

<Comparison of surface after 30 seconds >

P.C.D. Offset Diamond Wheel

This Offset Diamond Wheel can be used for removing of polyurethane, adhesive, paint, epoxy and acrylic coatings.



< Difference with the normal offset diamond >

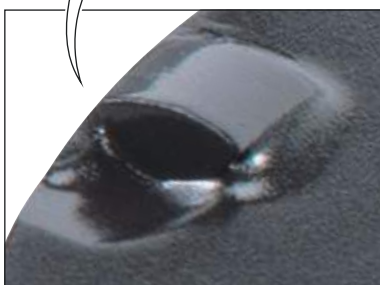





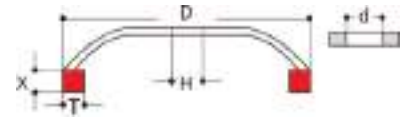

It just scratched the surface and couldn't remove the paint film.

Diamond

Offset Diamond Wheel





AA: Specially suitable, A: Suitable
(EN) : EN13236

Shape	Application	D	T	X	H	d	Color	For Material							For Model	Part No.
								1	2	3	4	5	6	7		
Rough work Single type																
	For coarse grinding work	105	8	4	22.23	-	Silver	A	AA	A	A	A			115mm Grinder	B-14629
Standard work Double type																
	For coarse grinding work, For removing point	125	7	5	22.23	-	Silver	AA	AA	AA	A	A			PC5000, 5001C	D-41458(EN)
	For coarse grinding work, For removing point	125	8	5	22.23	-	Gold	AA	AA	AA	A	A			PC5000, 5001C 125mm Grinder	B-12295(EN)
Segmented type																
	For coarse grinding work, For removing point	100	8	5	22.23	16	Gold	AA	AA	AA	A	A			100mm Grinder	A-87105
Rim type																
	For fine finishing	125	13	5	22.23	-	Silver	AA	AA	AA	A	A			PC5000, 5001C	D-41464(EN)
	For fine finishing	125	13.5	4	22.23	-	Gold	AA	AA	AA	A	A			PC5000, 5001C 125mm Grinder	B-12289(EN)
PCD Offset Diamond Wheel																
Shape	Application	D	T	X	H	d	Color	For Material							For Model	Part No.
	For removal of polyurethane, adhesive, paint, epoxy and acrylic coatings	125	-	-	22.23	-	Black	-	-	-	-	-	-	-	PC5000, 5001C 125mm Grinder	B-53160

Diamond

Offset Diamond Wheel for PC1100



Shape	Application	D	T	X	H	d	Color	For Material							For Model	Part No.
								1	2	3	4	5	6	7		
Standard work Segmented type																
	For coarse grinding work, For removing point	110	8	5	15	-	Silver	AA	AA	AA	A	A			PC1100	A-86321(EN)
Fine work Turbo type																
	For general use	110	13.5	4	15	-	Blue	AA	AA	AA	A	A			PC1100	A-07369(EN)
Rim type																
	For fine finishing	110	13.5	4	15	-	Silver	AA	AA	AA	A	A			PC1100	792289-1(EN)

SDS-Plus Diamond core bit (Dry type)



When drilling with diamond core bit, always use "rotation only".
SDS-Plus adapter (with center bit) A-87563
For Model:
SDS-PLUS hammers



Spindle thread M18

Capacity (Diameter x Depth)	Part No.
38 x 175mm	A-87535
54 x 175mm	A-87541
65 x 175mm	A-87557

Vacuum Brazed diamond core bit



Spindle thread M10
For: 100mm Angle Grinder

Size	Spindle thread	Part No.
5mm	M10 x 1.5	D-63264
6mm	M10 x 1.5	D-63270
8mm	M10 x 1.5	D-63286
10mm	M10 x 1.5	D-63292
12mm	M10 x 1.5	D-63301
14mm	M10 x 1.5	D-63317
16mm	M10 x 1.5	D-63323
20mm	M10 x 1.5	D-63339
25mm	M10 x 1.5	D-63345
32mm	M10 x 1.5	D-63351
37mm	M10 x 1.5	D-63367
40mm	M10 x 1.5	D-63373
50mm	M10 x 1.5	D-63389

Diamond Core Drill Bit for Grinders



	Vacuum brazed
Fix	Special chemical bond
Fixing strength of diamond	High
Cutting material	Marble, Granite, Porcelain Tile
Precision of cutting	Middle

Vacuum Brazed diamond pin drill

For: 13mm Driver Drill
Material : Granite/Marble/Porcelain Tile



Size	Spindle thread	Part No.
6mm	6mm x 12.5mm	B-51823
8mm	8mm x 12.5mm	B-51839
10mm	8mm x 12.5mm	B-51845

ACCESSORIES

▣ Planing / Routering



Planing / Routering

Planer blade (2 per pkg.)

HSS(High Speed Steel): Fine cutting surface. TC(Tungsten Carbide): Higher durability. Suitable for hard wood.



Size (mm)	Material	Part No.
For Model 1600		
80	HSS	793001-2
80	HSS	D-65501
For Model: 1100/N, N1900B, 1902, N1923B/H, KP0810/C, KP0800, DKP180, DKP140		
82	HSS	A-07406
82	TC	793007-0
82	HSS	D-67228
82	HSS (10pcs per pkg)	D-67234
For Model: 1002BA, 1911B		
110	HSS	D-71211
110	HSS	A-07412
110	TC	793009-6
110	TC	D-08822
For Model: 1804N		
136	TC	793012-7
136	HSS	A-07428
136	HSS	D-71227
For Model: 1805N		
155	TC	793015-1
155	HSS	793013-5
For Model: 2012NB		
306	HSS	793350-7
For Model: 2030		
155	HSS	793014-3
306	HSS	793018-5

Mini planer blade

(2 blades per pkg.)

The blade has edges on both sides for long life.

HSS(High Speed Steel): Fine cutting surface.

TC(Tungsten Carbide): Higher durability.

For Model:

1100/N, N1900B, 1902, N1923B/H, KP0810/C, KP0800, DKP180, DKP140

Size (mm)	Material	Type	Part No.
82	TC	-	A-82921
For Model: 2012NB			
306	HSS	-	793346-8

Cutter blade

Carbide-tipped plate joiner blade



For Model:

3901, PJ7000, DPJ180, DPJ140

*North American Package

Blade dia. (mm)	Hole dia. (mm)	Tip thickness (mm)	Region A
100	22	4	B-20644

Drywall guide bit

A: Diamond bit



For Model	Size	Type	Part No.
3706	3.18mm(1/8")	-	733229-0

Cutter blade

3501N

Dia. 120mm

For Model:



Width (mm)	Region A Part No.	Width (mm)	Part No.
2.4	793021-6	12	793031-3
3	793022-4	13.5	793032-1
3.9	793024-0	15	793039-7
4.5	793025-8	16.5	793040-2
5.5	793026-6	18	793041-0
6	793027-4	21	793042-8
7.5	793028-2	30	793043-6
9	793029-0	33	793044-4
10.5	793030-5	36	793045-2

Cutter chain

A: Use with the sprocket (part No. 221502-5) & chain bar (Part No. 122235-4)

For Model:

7104L



Size(mm)	Type	Part No.
16.5	-	A-16570

Planing / Routing

Router bit set (12pc/set)

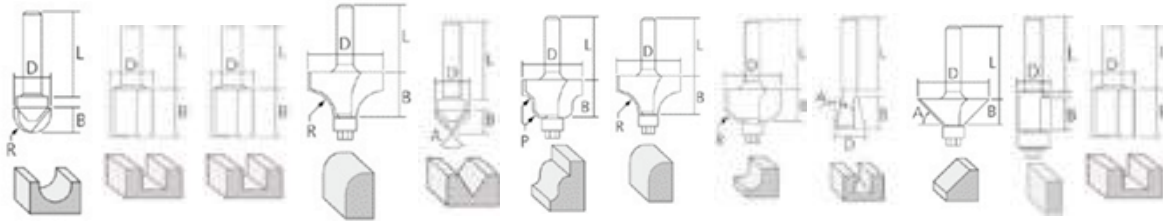

(mm)

Size	#1	#2	#3	#4	#5	#6	#7	#8	#9	#10	#11	#12	Part No.
8mm	D:12.7 R:6.35	D:16.0 B:20.0	D:6.0 B:20.0	D:28.6 R:9.5	D:12.7 B:9.1 A:90°	D:25.0 R:4.0 B:16.0	D:22.2 R:6.3 B:13.5	D:22.0 R:6.3 B:12.7	D:12.7 B:12.7 A:14°	D:32.0 B:12.2 A:45°	D:12.7 B:13.0 L:29.0	D:12.0 B:20.0 L:28.0	A-88054
6mm	B:8.8	L:28.0	L:25.0	L:25.5	L:29.0	L:26.5	L:25.0	L:26.5	L:29.0	L:30.0			A-87921
1/4"	L:29.0												A-91051

Router bit set (Straight Bit, Flush Trim Bit, Core Box bit)

(3pc/set)



Description	Shank dia. (inch)	Overall dia. (inch)	Carbide height (inch)	Length (inch)	Radius (R)	Part No.
Straight Bit	1/4	1/4	3/4	2-5/32	-	D-70465
Flush Trim Bit		1/2	1/2	2-3/16	-	
Core Box Bit		1/2	3/8	1-5/8	1/4	

Straight bit

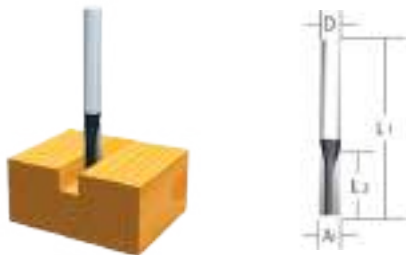

D	A1	L1	L2	Part No.
(mm)				
6	20	50	15	D-09313
6	6	50	18	D-09167
6	8	50	18	D-09260
12	10	60	25	D-10182
12	12	60	30	D-07892
(inch)				
1/4"	20	50	15	D-15431
1/4"	6	50	18	D-09173
1/4"	8	50	18	D-15388
1/2"	10	60	25	D-15512
1/2"	12	60	30	D-07901

"U" Grooving bit

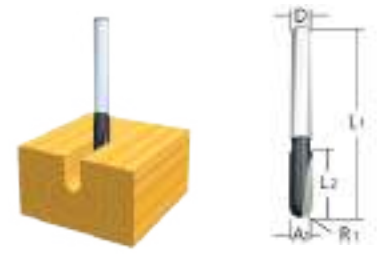

D	A1	L1	L2	R1	Part No.
(mm)					
6	6	50	18	3	D-09329

Planing / Routing

Drill point flush trimming bit



D	A1	L1	L2	L3	Part No.
(mm)					
6	6	60	18	28	D-09335
12	12	60	20	35	D-10584

Drill point double flush trimming bit



D	A1	L1	L2	L3	L4	Part No.
(mm)						
6	6	70	40	12	14	D-09341

Board-jointing bit



D	A1	L1	L2	L3	L4	Part No.
(mm)						
12	38	27	61	4	20	D-12027

Corner rounding bit

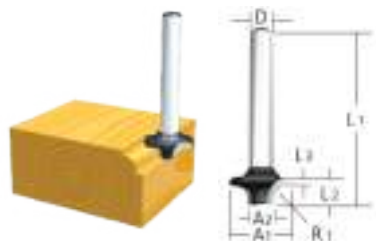

D	A1	A2	L1	L2	L3	R1	Part No.
(mm)							
6	25	9	48	13	5	8	D-09363
6	20	8	45	10	4	4	D-09357

Chamfering bit

B:Angle

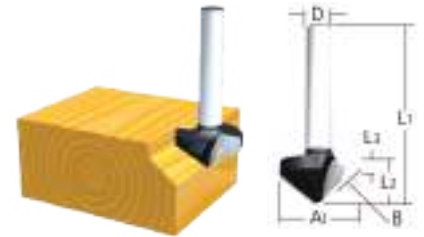

D	A1	L1	L2	L3	B	Part No.
(mm)						
6	20	50	13	5	45	D-09385
6	20	49	14	2	60	D-09391

Cove beading bit



D	A1	L1	L2	R1	Part No.
(mm)					
6	20	43	8	4	D-09400
6	25	48	13	8	D-09416

Ball bearing flush trimming bit



D	A1	L1	L2	Part No.
(mm)				
6	10	50	20	D-09472
(inch)				
1/4"	10	50	20	D-04313

Ball bearing beading bit



D	A1	A2	L1	L2	L3	R1	Part No.
(mm)							
6	20	12	40	10	5.5	4	D-09525
6	26	12	42	12	4.5	7	D-09547

Planing / Routering

Ball bearing corner rounding bit

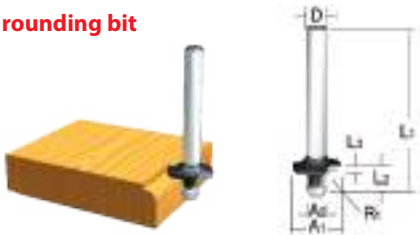

D	A1	A2	L1	L2	L3	R1	Part No.
(mm)							
6	15	8	37	7	3.5	3	D-09422
6	21	8	40	10	3.5	6	D-09444
(inch)							
1/4"	21	8	40	10	3.5	6	D-15475

Ball bearing cove beading bit



D	A1	A2	L1	L2	L3	R1	Part No.
(mm)							
6	20	18	40	10	5.5	3	D-09553

Ball bearing Roman Ogee bit



D	A1	A2	L1	L2	L3	R1	Part No.
(mm)							
6	20	8	40	10	2.5	4.5	D-09575
6	26	8	42	12	3	6	D-09581

Drill point sash router bit

For Model:
4402



D	A1	L1	L2	Part No.
(mm)				
6	6	65	18	D-16988
(inch)				
1/4"	6	65	18	D-16972

Economy type Router bit

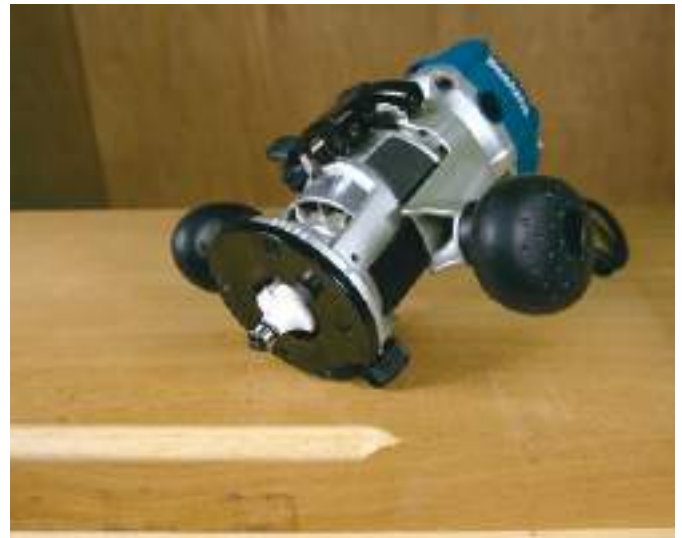

Straight bit 2 Flute

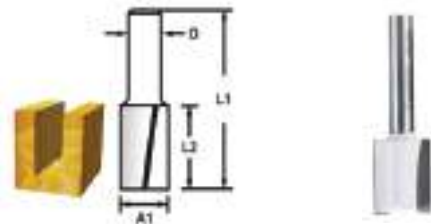

D	A1	L1	L2	Part No.
(inch)				
1/4"	1/4"	2-1/4"	1"	D-49052
1/2"	1/4"	2-1/2"	3/4"	D-62751
1/2"	5/16"	2-3/4"	1"	D-49183
1/2"	1/2"	2-5/8"	1"	D-62767
1/2"	1/2"	3"	1-1/2"	D-62773
1/2"	3/4"	2-5/8"	1"	D-62789
1/2"	3/4"	3"	1-1/2"	D-62795
1/2"	7/8"	2-5/8"	1"	D-62804

Straight bit Super

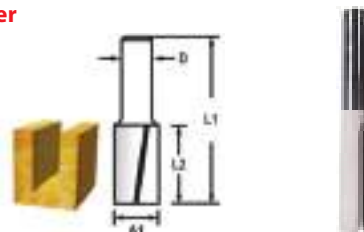

D	A1	L1	L2	Part No.
(inch)				
1/2"	1/2"	4"	2"	D-62810

Planing / Routing

Straight bit Pattern



D	A1	L1	L2	Part No.
(inch)				
1/2"	3/4"	2-13/16"	1"	D-62826

Straight bit 1 Flute

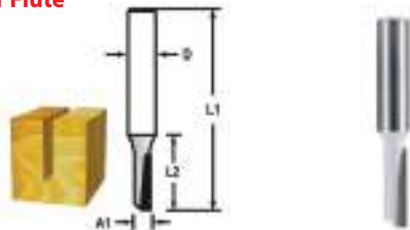

D	A1	L1	L2	Part No.
(inch)				
1/4"	1/4"	2"	3/4"	D-49030
1/2"	1/4"	2-1/2"	3/4"	D-62739
1/2"	3/8"	2-1/2"	1"	D-62745

Flush Trim Bit 2 Flute

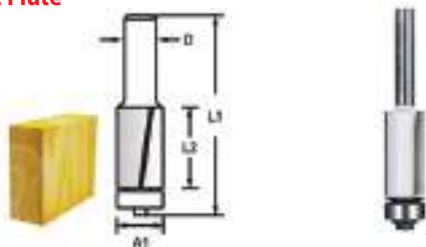

D	A1	L1	L2	Part No.
(inch)				
1/4"	3/8"	2-5/8"	1"	D-49264
1/2"	1/2"	3-19/32"	1-1/2"	D-62832
1/2"	1/2"	4-1/64"	2"	D-62848
1/2"	3/4"	3"	1"	D-62854
1/2"	3/4"	3-5/16"	1-1/4"	D-62860

Round Nose Bit

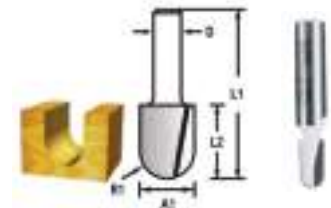

D	A1	L1	L2	R1	Part No.
(inch)					
1/4"	1/4"	1-3/4"	1/2"	1/8"	D-49345
1/2"	3/8"	2-1/4"	1/2"	3/16"	D-62876
1/2"	1/2"	2-3/8"	3/4"	1/4"	D-62882
1/2"	3/4"	2-5/8"	1"	3/8"	D-62898

V Groove Bit

B:Angle

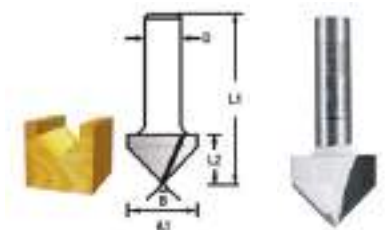

D	A1	L1	L2	B	Part No.
(inch)					
1/4"	3/4"	1-7/8"	5/8"	90dg	D-49373
1/2"	7/8"	2-1/4"	5/8"	90dg	D-62907
1/2"	1"	2-3/8"	3/4"	90dg	D-62913

Roundover Bit - with Bearing

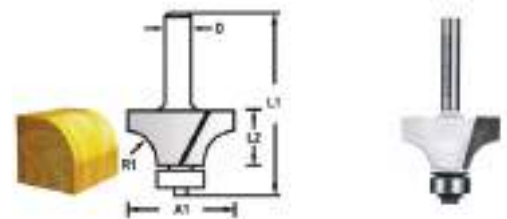

D	A1	L1	L2	B	Part No.
(inch)					
1/2"	5/8"	2-5/32"	15/64"	1/16"	D-63046
1/2"	3/4"	2-5/16"	3/8"	1/8"	D-63052
1/2"	1-1/4"	2-11/16"	21/32"	3/8"	D-63068
1/2"	1-1/2"	2-11/16"	3/4"	1/2"	D-63074

ACCESSORIES

▣ Outdoor Power Equipment



Outdoor Power Equipment

Cordless string trimmer

Model No.	Spindle Size	Receive Washer		Grass Guard for Receive Washer
		Size (mm)	Parts No.	
DUR364L	M8x1.25RH	44	319245-2	346857-8
DUR142L, DUR142U, DUR143U, DUR182L, DUR182U, DUR183L, DUR183U	M8x1.25LH	41	-	346622-5
DUR184L	M8x1.25RH	36.5	326683-1	346857-8
DUR187L, DUR187U, DUR188L, DUR188U	M8x1.25LH	36.5	-	346857-8
DUR189	M8x1.25RH	36.5	-	346857-8

Brushcutter blades

Hole Dia.: 25.4mm

* Japanese Package

	Application	Blade dia. / No. of teeth	Thickness	Model No.	Part No.
2-tooth blade					
	for tall, thick grass, scrub and tangled undergrowth	230mm / 2	2.0mm	BBC231U, BBC300L, BC231UD, BC300LD, DUR361U, DUR362U, EBH252U, EBH253U, EM2500U/L, EM2510LH, EM2511LH, EM2600U/L, EM2650LH/UH, EM2651LH/UH, EM2653LH, EM2654LH, EM400MP, EM401MP, EM402MP, EM403MP, EM404MP	197808-2 D-66058
3-tooth blade					
	for tall, thick grass, scrub and tangled undergrowth	230mm / 3	3.0mm	BBC231U, BBC300L, BC231UD, BC300LD, DUR361U, DUR362U, EBH252U, EBH253U, EM2500U/L, EM2510LH, EM2511LH, EM2600U/L, EM2650LH/UH, EM2651LH/UH, EM2653LH, EM2654LH, EM400MP, EM401MP, EM402MP, EM403MP, EM404MP	195298-3 D-66020
4-tooth blade					
	for tall grass and scrub	230mm / 4	1.8mm	BBC231U, BBC300L, BC231UD, BC300LD, DUR361U, DUR362U, EBH252U, EBH253U, EM2500U/L, EM2510LH, EM2511LH, EM2600U/L, EM2650LH/UH, EM2651LH/UH, EM2653LH, EM2654LH, EM400MP, EM401MP, EM402MP, EM403MP, EM404MP	B-14118 D-66008
		255mm / 4	2.0mm	EBH340U/R, EBH341L/U/R, EM2901LH/UH, EM2904LH, EM3400U/L, EM4350UH/LH/RH, EM4351UH, RBC411U, RBC412U, RBC413U, RBC414U	B-14124
8-tooth blade					
	for thick grass and scrub	255mm / 8	2.0mm	EBH340U/R, EBH341L/U/R, EM2901UH/LH, EM3400U/L, EM4350UH/LH/RH, EM4351UH, RBC411U, RBC412U, RBC413U, RBC414U	B-14146
Saw blade					
	for bushes and thin tree trunks	230mm / 80	1.8mm	BBC231U, BBC300L, BC231UD, BC300LD, DUR361U, DUR362U, EBH252U, EBH253U, EM2500U/L, EM2510LH, EM2511LH, EM2600U/L, EM2650LH/UH, EM2651LH/UH, EM2653LH, EM2654LH, EM400MP, EM401MP, EM402MP, EM403MP, EM404MP	B-14152
	Not available in some countries due to local regulation	255mm / 80	2.0mm	EBH340U/R, EBH341L/U/R, EM2901LH/UH, EM2904LH, EM3400U/L, EM4350UH/LH/RH, EM4351UH, RBC411U, RBC412U, RBC413U, RBC414U	B-14168
TCT Saw blade					
	for gnarled bushes and thin tree trunks	230mm / 36	1.25mm	EBH252U, EBH253U, EBH340U/R, EBH341U/L, EBH341R, EM2500U/L, EM2510LH, EM2511LH, EM2600U/L, EM2650LH/U, EM2651L/U, EM2653LH, EM2654LH, EM4340L	A-48321 D-65981
	Not available in some countries due to local regulation	250mm / 40	1.25mm	EBH340U/R, EBH341L/U/R, EM2901LH/UH, EM2904LH, EM3400U/L, EM4350UH/LH/RH, EM4351UH, RBC411U, RBC412U, RBC413U, RBC414U	A-48337

*Special flunge (Dia : 20mm) ••• Part No.332051-8 (Including Chisel blade guard set 196480-7,196481-5)

Edger blade



Blade dia. / No. of teeth	Thickness	Model No.	Part No.
203mm / 2	2.5mm	EE2650H, EE400MP	196745-7

Outdoor Power Equipment

String trimmer head

(for grass, light weeds)

* with adapter (Poly bag with header)

Description	Ref.	Size	Arbore size	Model No.	Cord/ Line	with adapter	Parts No.
 <p>There is no need to ever split the trimmer head to replace or remove line. This head is simple to operate with reliability in performance.</p>	UN-74L	4.4"	M10x1.25LH	BBC231U, BBC300L, BC231UD, BC300LD, EBH252U/L, EBH253U/L, EM2510LH, EM2511LH, EM2650UH/LH, EM2651UH/LH, EM2653LH, EM2654LH, EM2901LH/LHN/UH, EM2902LHN, EM2904LH/LHN, EM2905LHN, EM400MP, EM401MP, EM403MP, EM404MP, EM405MP, EM406MP	2.4mm x 3.6m	-	196324-1

	95-M10L	4"	M10x1.25LH	BBC231U, BBC300L, BC231UD, BC300LD, DUR365U, DUR366L, EBH252U/L, EBH253U/L, EM2510LH, EM2511LH, EM2650UH/LH, EM2651UH/LH, EM2653LH, EM2654LH, EM2901LH/LHN/UH, EM2902LHN, EM2904LH/LHN, EM2905LHN, EM400MP, EM401MP, EM403MP, EM404MP, EM405MP, EM406MP	2.0mm x 3m	Poly bag with header	197804-0
					2.4mm x 3m	Poly bag with header	
					2.7mm x 3m	Poly bag with header	

	Bump & Feed ECO 4L	4" Low profile	M10x1.25LH	DUR365U, DUR366L	2.0mm x 3m	Poly bag with header	197296-3
	Bump & Feed Z5L	5"	M10x1.25LH	EBH252U/L, EBH253U/L, EM2510LH, EM2511LH, EM2650UH/LH, EM2651UH/LH, EM2653LH, EM2654LH, EM2901LH/LHN/UH, EM2902LHN, EM2904LH/LHN, EM2905LHN, EM3400U/L, EBH340U, EBH341U/L/R, EM4350UH/LH/RH, EM4351UH, RBC411U, RBC412U, RBC413U, RBC414U, EM400MP, EM401MP, EM403MP, EM404MP, EM405MP, EM406MP	2.4mm x 3m	Blister pack	B-05131

Automatic feed and Bump & Feed							
 <p>Line will be feed about 3cm, in either one of the following cases-Head rotation are reached at 8,500rpm. -Bottom of the head is bumped on the ground when it is spinning.</p>	Ultra Auto 4R	4"	M8x1.25RH	ER2550L, ER2650L, ER2600L, ER400MP	2.4mm x 3m	Carton box	
	Ultra Auto 4L	4"	M8&10x 1.25 LH	DUR187U/L, DU188U/L, EM2500U/L, EM2600U/L, BBC231U, BBC300L, BC231UD, BC300LD, EBH252U/L, EBH253U/L, EM2510LH, EM2511LH, EM2650UH/LH, EM2651UH/LH, EM2653LH, EM2654LH, EM2901LH/LHN/UH, EM2902LHN, EM2904LH/LHN, EM2905LHN, EM400MP, EM401MP, EM403MP, EM404MP, EM405MP, EM406MP	2.4mm x 3m	Carton box	*B-02945

Eyelet 2pcs/set for Bump & Feed 4L/4R/Z5L, Ultra Auto 4R/4L/6L Part No. A-15992

	-	5"	-	BBC231U, BBC300L, BC231UD, BC300LD, EBH252U/L, EBH253U/L, EM2510LH, EM2511LH, EM2650UH/LH, EM2651UH/LH, EM2653LH, EM2654LH, EM3400U/L, EBH340U/R, EBH341U/L/R, EM2901LH/LHN/UH, EM2902LHN, EM2904LH/LHN, EM2905LHN, EM4350UH/LH/RH, EM4351UH, RBC411U, RBC412U, RBC413U, RBC414U, EM400MP, EM401MP, EM403MP, EM404MP, EM405MP, EM406MP	2.4mm x 0.75m x 2	Carton box	B-02951
---	---	----	---	--	-------------------	------------	---------

Nylon cord



Size	Part No.
1.65mmx15m	DA00000003
2.4mmx5m	B-01971
3.0mmx4m	B-07375

Four-leaf clover-like cross section

Spiral cord body





Size	Color	Part No.
1.65mmx15m	Blue	E-01731
2.0mmx15m	Green	E-01769
2.0mmx15m	Green	197472-9
2.0mmx30m	Green	197473-7

Size	Color	Part No.
2.0mmx30m	Green	E-01775
2.0mmx310m	Green	E-01781
2.4mmx15m	Orange	198501-1
2.4mmx15m	Orange	E-01797
2.4mmx30m	Orange	E-01806
2.4mmx30m	Orange	198502-9
2.4mmx225m	Orange	E-01812

Outdoor Power Equipment

Protection guard

Shape	Model No.	Description	Part No.
	EBH340U, EM3400U/L, RBC411U	Toolless / With cord/line cutter	140424-9
	EM2510LH, EM2511LH, EM2653LH, EM2654LH	-	197806-6
	EM2901LH/LHN/UH, EM2902LH/LHN, EM2904LH/LHN, EM2905LHN, EM405MP, EM406MP	Narrow type / Without cord/line cutter	457273-0
Conversion kit for Cutting blade (Protector for Cutting blade, Protector clamp and blade clamping washer & nut.)	DUR184L, DUR189	Without cord/line cutter	456651-1

Replacement plastic blade



Model No.	Per pkg.	Part No.
DUR187L, DUR187U, DUR188L, DUR188U, DUR189, DUR364L, DUR365U, DUR366U, EM403MP, EM404MP, EM405MP, EM406MP	12	198427-7



Spool assembly



Model No.	Part No.
UR3000	DA00000001
UR140D, DUR141, UR180D, DUR181	196146-9

Shoulder strap assembly





Single
125516-5



*Poly bag with header

Type	Model No.	Part No.
Single	DUR141, DUR142L/U, DUR143U, DUR181, DUR182L/U, DUR183L/U, DUR184L, DUR187L, DUR188L, DUR189, DUR364L, DUR365U, DUR366L, DUX60L, EBH252L, EBH253L, EBH341L, EM2510LH, EM2511LH, EM2650LH, EM2651LH, EM2653LH, EM2654LH, EM2901LH/LHN/UH, EM2904LH, EM3400L, EN4950H, EN4951SH, EY2650H, EX2650LH, RBC411U, RBC412U, UR100D, UR140D, UR180D	125516-5







Attachments







Shape	Model No.	Part No.
	EM2650LH, EM2651LH, EM2653LH, EN2654LH	198579-4
	EM2650LH, EM2651LH, BBC300L	A-89539
	DBC260L, EM2651LH	B-80210
	EBH340R, EBH341R	B-80226
	EBH340R, EBH341R	197163-2
	EBH340R, EBH341R	195252-7

Outdoor Power Equipment

Multi-tool attachments

*Europe

Shape	Model No.	Part No.
Brushcutter Cutting width: 420mm Spindle size: M10 x 1.25LH		EX2650LH 195658-9 / EM400MP
String trimmer Cutting width: 410mm Spindle size: M8 x 1.25RH		EX2650LH 195530-5 / ER400MP
Brushcutter Blade size: 230mm Spindle size: M10 x 1.25LH		DUX60, EX2650LH, BUX360, UX360D, UX361D, BUX361, UX362D, BUX362 195952-9 / EM402MP
Pole saw		DUX60, EX2650LH, BUX360, UX360D, UX361D, BUX361, UX362D, BUX362 195697-9 / EY401MP
Power sweep attachment		DUX60 199344-4 / SW400MP
Power brush attachment		DUX60 199323-2 / BR400MP
Shaft Extension		DUX60 196031-6 / LE400MP

Shape	Model No.	Part No.
Pole hedge trimmer Angle adjustment		DUX60, EX2650LH, BUX360, UX360D, UX361D, BUX361, UX362D, BUX362 196341-1 / EN401MP
Straight		DUX60, EX2650LH BUX360, UX360D, UX361D, BUX361, UX362D, BUX362 197742-6 / EN410MP
Ground trimmer		DUX60, EX2650LH, BUX360, UX360D, UX361D, BUX361, UX362D, BUX362 198061-3 / EN420MP
Cultivator		DUX60, EX2650LH, BUX360, UX360D, UX361D, BUX361, UX362D, BUX362 195712-9 / KR400MP 195716-1 / KR401MP
Coffee harvester		DUX60, EX2650LH, BUX360, UX360D, UX361D, BUX361, UX362D, BUX362 195726-8 / EJ400MP
Edger attachment		DUX60, EX2650LH BUX360, UX360D, UX361D, BUX361, UX362D, BUX362 196750-4 / EE400MP

Chainsaw Accessories

Guide Bar / Chain Blade / Guide Bar Cover

Guide Bar

Sprocket nose bar



Carving bar



Saw Chain



Bar Cover



Cutter type SC: Semi chisel FC: Full chisel

For Models	Guide Bar		Saw Chain					Bar Cover Part No.	File diameter, 1st half of top plate	File diameter 2nd half of top plate		
	Bar length	Part No.	No. of drive links	gauge	pitch	Cutter type	Saw Chain Part No.					
Electric Chain Saws												
BUC250	25cm/10"	168407-7	60	1.3mm/0.050"	1/4"	25AP	SC	194098-8	452093-7	4.0mm	4.0mm	Carving bar
	25cm/10"	168408-5	40	1.3mm/0.050"	3/8"	91VG	SC	196205-9	452093-7	4.0mm	4.0mm	Sprocket
UC120D, BUC121, BUC122	16cm/6-1/4"	158476-6	42	1.3mm/0.050"	1/4"	25AP	SC	791284-8	416311-7	4.0mm	4.0mm	-
UC3510A, UC3520A	35cm/14"	165246-6	52	1.1mm 0.043"	3/8"	90SG	SC	531 291 652	419288-5	4.5mm	4.0mm	Sprocket
UC4010A, UC4020A	40cm/16"	165247-4	56	1.1mm 0.043"	3/8"	90SG	SC	531 291 656	419242-9	4.5mm	4.0mm	Sprocket
UC3020A	30cm/12"	165200-0	46	1.3mm/0.050"	3/8"	91VG	SC	531 492 646	419288-5	4.0mm	4.0mm	-
UC3520A	35cm/14"	165201-8	52	1.3mm/0.050"	3/8"	91VG	SC	531 492 652	419288-5	4.0mm	4.0mm	-
UC4020A	40cm/16"	165202-6	56	1.3mm/0.050"	3/8"	91VG	SC	531 492 656	419242-9	4.0mm	4.0mm	-
		422 040 661										
UC3500, UC3530A	35cm/14"	165201-8	52	1.3mm/0.050"	3/8"	91VG	SC	531 492 652	-	4.0mm	4.0mm	-
		442 035 661										
UC4030A	40cm/16"	165202-6	56	1.3mm/0.050"	3/8"	91VG	SC	531 492 656	419242-9	4.0mm	4.0mm	-
		442 040 661										
5012B	30cm/12"	164533-0	45	1.3mm/0.050"	3/8"	91VG	SC	196519-6	410054-3	4.0mm	4.0mm	-
5016B	40cm/16"	341650-5	56	1.3mm/0.050"	3/8"	91VG	SC	196521-9	410054-3	4.0mm	4.0mm	-
DUC302	30cm/12"	165245-8	46	1.1mm/0.043"	3/8"	90SG	SC	531 290 046	419288-5	4.5mm	4.0mm	Sprocket
5014B	35cm/14"	345159-9	52	1.1mm/0.043"	3/8"	90SG	SC	791091-9				Sprocket
Petrol Chain Saws												
DCS231T	25cm/10"	168408-5	40	1.3mm/0.050"	3/8"	91VG	SC	196205-9	452093-7	4.0mm	4.0mm	Sprocket
DCS330TH	35cm/14"	442 035 661	52	1.3mm/0.050"	3/8"	91VG	SC	531 492 652	952 100 633	4.0mm	4.0mm	-
DCS3400TH, DCS3410TH	35cm/14"	442 035 661	52	1.3mm/0.050"	3/8"	91VG	SC	531 492 652	-	4.0mm	4.0mm	-
DCS3400, DCS3410	35cm/14"	442 035 661	52	1.3mm/0.050"	3/8"	91VG	SC	531 492 652	-	4.0mm	4.0mm	-
EA3201S-35, DCS33, DCS34, DCS330, DCS330S, DCS340, DCS341, DCS344, DCS390, DCS400, DCS401	30cm/12"	442 030 661	46	1.3mm/0.050"	3/8"	91VG	SC	531 492 646	-	4.0mm	4.0mm	-
	35cm/14"	442 035 661	52					531 492 652	-			
	40cm/16"	442 040 661	56					531 492 656	-			
DCS3500, DCS3501	35cm/14"	442 035 661	52	1.3mm/0.050"	3/8"	91VG	SC	531 492 652	952 010 630	4.0mm	4.0mm	-
	40cm/16"	442 040 661	56					531 492 656	-			
DCS43, DCS52, DCS430, DCS431, DCS520	38cm/15"	443 038 651	56	1.3mm/0.050"	3/8"	91VG	SC	523 093 656	952 020 650	5.5mm	4.8mm	-
	45cm/18"	443 045 651	64					523 093 664	952 020 650			
DCS4300i, DCS5200, DCS5200i, DCS6000i, DCS6800i	38cm/15"	443 038 651	56	1.5mm/0.058"	3/8"	73DP	SC	522 094 656	-	5.5mm	4.8mm	-
	45cm/18"	443 045 651	64					522 094 664	-			
	38cm/15"	443 038 651	56	1.5mm/0.058"	3/8"	73LP	FC	528 099 656	-	5.5mm	4.8mm	-
	45cm/18"	443 045 651	64					528 099 664	-			
	60cm/24"	445 060 451	84					528 099 684	952 020 660			
	445 060 455	84	528 099 684					952 020 660				
EA6100, EA7900, DCS6400, DCS6401, DCS6400H, DCS7300, DCS7300H, DCS7301, DCS7900, DCS7900H, DCS7901, PS7300, PS7900	45cm/18"	445 045 655	72	1.3mm/0.050"	0.325	95VP	-	512 484 772	952 020 650	5.5mm	4.8mm	-
	45cm/18"	445 045 655	68					528 099 668	952 020 650			
	50cm/20"	445 050 655	72					528 099 672	952 020 650			
	60cm/24"	-	84					528 099 684	952 020 660			
	70cm/28"	455 070 455	94					528 099 694	-			
	60cm/24"	445 060 451	84					528 099 684	952 020 660			
	445 060 455	84	528 099 694					-				
	70cm/28"	455 070 455	94					528 099 694	-			
DCS9000, DCS9010, PS9010	50cm/20"	443 050 652	72	1.5mm/0.058"	3/8"	73LP	FC	528 099 672	952 020 650	5.5mm	4.8mm	-
	60cm/24"	443 060 652	80					528 099 680	952 020 660			
	76cm/30"	443 076 422	92					528 099 696	-			
EA4301F	45cm/18"	442 045 661	62	1.3mm/0.050"	3/8"	95VP	SC	531 492 662	-	-	-	Sprocket
		445 045 655	72					531 492 662	-			Sprocket
DCS430, DCS460, DCS520, 109	45cm/18"	445 045 451	64	1.5mm/0.058"	3/8"	73LP	FC	528 099 664	-	-	-	Solid
		443 045 651						523 093 664	-			Sprocket
DCS6000i, DCS6400, DCS6401, PS6400	50cm/20"	445 050 455	72	1.5mm/0.058"	3/8"	73LP	FC	528 099 672	-	-	-	-
DCS520, DCS6000i, 111	53cm/21"	445 053 451	72	1.5mm/0.058"	3/8"	73LP	FC	528 099 672	-	-	-	Solid
		443 053 651						528 099 672	-			Sprocket
EA3201S	40cm/16"	165247-4	56	1.1mm/0.043"	3/8"	90SG	SC	531 291 656	419242-9	4.5mm	4.0mm	-

Chainsaw Accessories

Model No.	Guide Bar				Saw Chain						Bar Cover	Drive sprocket	
	Bar length	Motor Mount	Type	Part No.	No.of drive links	gauge	pitch	Type OREGON / DOLMAR	Cutter type	Part No.	Part No.	Type	Part No.

Cordless Chain Saws

UC120D,	16cm/6-1/4"	-	without Sprocket	158476-6	42	1.3mm/ .050"	1/4"	25AP / 466	MC	791284-8	416311-7	Sprocket	221504-1
DUC121, DUC122	16cm/6-1/4"	-	without Sprocket	158476-6	42	1.3mm/ .050"	1/4"	25AP / 466	MC	791284-8	416311-7	Sprocket	221527-9
DUC204 DUC254 DUC254C	25cm/10"	-	Solid carving bar	168407-7	6	1.3mm/ .050"	1/4"	25AP / 466	MC	194098-8	452093-7	-	-
	20cm/8"	A041	Sprocket nose bar	-	33	1.1mm/ .043"	3/8" LP	90PX / 291	CC	-	-	-	-
	25cm/10"	A041	Sprocket nose bar	-	40					-	452093-7		
	25cm/10"	A041	Sprocket nose bar	168408-5	40	1.3mm/ .050"	3/8" LP	91PX / 492	CC	196205-9	452093-7	-	-
BUC250, UC250D, BUC300, UC300D, DUC252, DUC302	25cm/10"	-	Solid carving bar	168407-7	60	1.3mm/ .050"	1/4"	25AP / 466	MC	194098-8	452093-7	-	-
	25cm/10"	A041	Sprocket nose bar	168408-5	40	1.3mm/ .050"	3/8" LP	91PX / 492	CC	196205-9	452093-7	Sprocket	221526-1
	30cm/12"	A041	Sprocket nose bar (Micro-Lite)	165245-8	46	1.1mm/ .043"	3/8" LP	90PX / 291	CC	196740-7	-		
DUC303, DUC353, DUC400	25cm/10"	-	Solid carving bar	168407-7	60	1.3mm/ .050"	1/4"	25AP / 466	MC	194098-8	452093-7	Sprocket	-
	30cm/12"	A041	Sprocket nose bar (Micro-Lite)	165245-8	46	1.1mm/ .043"	3/8" LP	90PX / 291	CC	196740-7	419288-5	Sprocket	199063-2
	35cm/14"	A041		165246-6	52					531291652	419288-5		
	40cm/16"	A041		165247-4	56					531291656	419242-9		
	30cm/12"	A041	Sprocket nose bar	165200-0	46	1.3mm/ .050"	3/8" LP	91PX / 492	CC	531492646	419228-5		
	35cm/14"	A041	Sprocket nose bar	165201-8	52					196207-5	419288-5		
	40cm/16"	A041	Sprocket nose bar	165202-6	56					531492656	419242-9		
40cm/16"	A041	Sprocket nose bar	165202-6	56	531492656					419242-9			

Electric Chain Saws

UC3041A, UC3541A, UC4041A	30cm/12"	A041	Sprocket nose bar (Micro-Lite)	165245-8	46	1.1mm/ .043"	3/8"	90PX / 291	CC	196740-7	419288-5	-	-
	35cm/14"	A041		165246-6	52					-	419288-5		
	40cm/16"	A041		165247-4	56					-	419242-9		
	30cm/12"	A041	Sprocket nose bar	-	46	-	419288-5						
	35cm/14"	A041		165201-8	52	1.3mm/ .050"	3/8"	91PX / 492	CC	-	419288-5		
	40cm/16"	A041		165202-6	56	-	419242-9						
UC3050A, UC3550A, UC4050A, UC4550A, UC3051A, UC3551A, UC4051A, UC4551A	30cm/12"	A041	Sprocket nose bar	-	46	1.3mm/ .050"	3/8"	91PX / 492	CC	-	419288-5	Sprocket	221521-1
	35cm/14"	A041		165201-8	52					-	419288-5		
	40cm/16"	A041		165202-6	56					-	419242-9		
	45cm/18"	A041		-	-					-	419242-9		



Outdoor Power Equipment

Bar nut



* Pole saw attachment (196315-2)

Model No.	Part No.
EA4300F, EA5001P, EA5000P, EA5001F, EA6100P, EA6101P, EA7300P, EA7301P, EA7900P, EA7901P	252145-2

File and File holder

For Model:
Chain saw
*with grip



Saw chain type	Size	File	File and File holder
		Part No.	Part No.
25AP, 91PX, 91VLX, 466, 492, 196	4mm	*744003-1	-
	4mm	953003090	953030010
20BPX, 21BPX, 21LPX, 95VPX, 082, 086, 686, 484	4.8mm	953003070	-
72V, 72DPX, 72LPX, 73DPX, 73LPX, 496, 093, 099	5.5mm	953003040	-

File handle, Flat file & Depth gauge jointer

For all saw chain



File handle	Flat file	Depth gauge jointer
Part No.	Part No.	Part No.
953004010	953003060	953100090

Fuel mixture



Size	Part No.
1L	456236-3

Chain oil

With Makita chain oil, chain oiling is formulated to adhere to the bar and chain and to reduce wear. Adhesion additive helps keep sap and pitch from clinging to the bar and chain. (Not available in Austria)



Size	Part No.
100ml	182229-1
1L	988002656

Chip receiver assembly set

Keeps branch or leaf debris from scattering around.
• Attachable to either side of the blade



Model No.	Description	Part No.
UH201D, *UM600D	One-touch installation/removal	EU: 198401-5
BUH550, BUH650, UH550D, UH650D, UH4570, UH5570, UH5580, UH6580, UH6850, UH7580	One-touch installation/removal	194681-1

Protection of extension cord



Type	Description	Part No.
A	Arm band complete set	194679-8
B	Cord holder complete set	194677-2
C	Hook complete	158024-1

Shear blade & Blade cover for Grass Shear



Model No.	Blade assembly	Blade cover
	Part No.	Part No.
UM103D, UM104D	-	410540-4
DUM166, DUM168, DUM604, UM164D, UM165D, UM167D, UM600D, UM603D	195267-4	452055-5

Conversion from Hedge Trimmer to Grass Shear

*with grass receiver and crank cover.

UH200D	195267-4	452055-5
UH201D	195267-4	

Outdoor Power Equipment

Shear blade & Blade cover for Hedge Trimmer



*with clank cover
**for blade without end cover
***for blade with end cover

Model No.	Blade assembly	Blade cover
	Part No.	Part No.

AC Hedge Trimmer

UH4261	194660-9	450489-6
UH5261	194663-3	
UH5570	194671-4	
UH5580	194673-0	450490-1
UH6580	194666-7	
UH6570	194675-6	
UH7580	194675-6	

Pole Hedge Trimmer (Cordless, Petrol, Multi-tool attachments)

EN420MP	198195-2	-
---------	----------	---

Cordless Hedge Trimmer

UH200D, UH201D	EU:198408-1	451816-0
BUH550, UH550D, DUH551	-	450489-6
BUH650, UH650D, DUH651	-	450490-1
DUH521, DUH523U, UH520D, UH522D	195769-0	-

Conversion from Grass Shear to Hedge Trimmer

*with crank cover

DUM604, UM600D, UM603D, DUM166, DUM168, UM164D, UM165D, UM167D	EU:198408-1	451816-0
--	-------------	----------

Base frame



*with grass Shear blade

Model No.	Part No.
UM164D, *UH200D	325896-1

Grass Receiver



*with grass Shear blade

Model No.	Part No.
DUM604, UM600D, UM603D, *UH201D	457426-1

Long attachment handle (Extension handle kit)

Photo:198486-1



*with grass Shear blade

Model No.	Part No.
DUM604, UM600D, UM603D, *UH201D	EU:198486-1

Rotary lawn mower blade



Model No.	Size(mm)	Part No.
-----------	----------	----------

Cordless Lawn Mower

BLM430, LM430D	430	197761-2
BLM381, DLM380	380	196863-1

Electric Lawn Mower

ELM3311	330	671002550
ELM3711	371	671002549
ELM4110	410	671001427

Petrol Lawn Mower

PLM4620N2, PLM4621N2, PLM4622N2, PLM4626N, PLM4627N, PLM4628N	460	671001451
PLM4630N2, PLM4631N2, PLM4632N	460	671014610

Earth auger drill bit set

(Comes with socket, pin and Orings) / Pouch



Bit Dia. (mm)	Length (mm)	Working length (mm)	Part No.
20	600	530	B-54302
25	600	530	B-54318
30	600	530	B-54324
35	600	530	B-54330
40	600	530	B-57576

Outdoor Power Equipment

Pipe, End pipe, Flat nozzle & others accessory



Model No.	
EB5300TH, EB5300WH, EB7660TH, EB7660WH	Long pipe 90 set
	Short pipe 90 set
	End nozzle 90-60
	End nozzle 90-62
	End nozzle 90-68
	End nozzle 90-70
	Flat nozzle
	Hip belt
	Sternum strap
PM7650H, PM7651H	Nozzle 0.5
	Nozzle 0.8
	Nozzle 0.7
	Bent pipe 630
	Straight pipe 630
	Straight pipe 380
	End pipe 200
	End pipe 450
	Flat pipe
	Top adapter
	Deflector set
	O ring set
	Hip belt set
	Sternum strap
BHX2500, BHX2501	Pipe
	End Pipe (Flat nozzle)
EB2901H, EB2902HV	End nozzle 68
	Flat nozzle
	Gutter cleaning nozzle set
DUB362	Extension Nozzle
	Flat nozzle
UB0801	Shoulder belt
	Bending nozzle

Nozzle assembly

A:Standard equipment



Model No.	Size(mm)	Type	Part No.
DUB182, DUB142, UB1100, UB1101, UB121D, UB141D, UB181D	220	A	132025-7
	430	-	134182-7
UB1102, UB1103	220	A	123245-4

Bending long nozzle set

* long nozzle



Model No.	Part No.
UB1102, UB1103	196729-5
DUB143, DUB183	TP0000199

Dust Bag



Model No.	Part No.
UB1100, UB1101	122321-1
DUB142, DUB182	122814-8

Flexible hose set

(Total length: 95cm)



Model No.	Part No.
DUB142, DUB182, UB1100, UB1101	191750-9

Outdoor Power Equipment

Vacuum attachment

For Model BHX2500, BHX2501



Part No.

195282-8

195284-4



Spark plug

Type	Part No.
NGK CMR4A	168534-0
NGK CMR6A	168401-9
NGK CMR6H	168652-4
NGK CMR7A-5	168599-2 965603040
NGK BPMR7A	168648-5 965603021
NGK BPM7A	168588-7
NGK BPMR8Y	649500-1
NGK BMR7A	168662-1



Pipe & End Pipe

(Flat nozzle)

Pipe



End Pipe
(Flat nozzle)



High-performance two-stroke engine oil 50:1

*with measuring cup

Makita High-performance two-stroke engine oil is semi-synthetic oil with excellent lubricating qualities, low smoke and low carbon residue. Contains additives that effect fuel stabilization.



Size	Part No.
1L	980008607

Safety goggles

Photo:
195246-2

Part No.











192219-6



Model No.	Pipe	End Pipe (Flat nozzle)
BHX2500, BHX2501	451752-0	451753-8
BHX7600	-	6679504400

















Outdoor Power Equipment

Sprayer accessories

Shape	Model No.	Features/ Recommended use	Part No.
Wide angle herbicide nozzle 	EF1550RH EVH2000	for spraying herbicides; also ideal for watering plants or spraying soil conditioner	6908031000
Herbicide nozzle 		Hard to become mist preventing diffusion of medicine.	6958011000
Y-shaped double nozzle 		for general pesticide applications using insecticides, fungicides, etc.	6958025000
Long two head nozzle 		Wide spraying with wide angle outlet.	6949001000
U-shaped double nozzle 		Wide spraying with wide angle outlet.	6958018000
Triple concentric nozzle 		Spraying in the form of circular.	6909500100
Quadruple concentric nozzle 		Spraying in the form of circular.	6919500000
Compact nozzle 	EVH2000	Convenient for spraying in the green house by compact nozzle.	6939025000
Jet nozzle 2 		Diffusion or straight is selectable with one tach	6939024000
Super jet nozzle 		Diffusion or straight is selectable.	6939028000

Power washer accessories for DHW080, HW1200, HW1300

Shape		Part No.
Trigger gun set 	-	197842-2
Variable nozzle set 	-	197822-8

Shape		Part No.
Variospray lance set 	-	197876-5
Cyclone jet nozzle set 	-	197824-4
Cyclone guard set 	-	197864-2
Under body spray lance set 	(for 110-127V) (for 220V-240V)	197859-5 198909-9
Extension pipe set 	0.9m 1.3m 1.7m	197870-7
Rotating brush set 	-	197831-7
Wash brush set 	-	197828-6
Foam nozzle set 	-	197886-2
Pipe cleaning hose 	10m 15m	197837-5 197840-6
High pressure extension hose 	5m 8m 10m	197845-6 197847-2 197850-3
Twist prevention joint set 	-	197867-6
Self-suction hose set 	-	197873-1
Accessory joint set 	- - -	197853-7
Absorption connector set 	-	197881-2
One touch joint set 	-	197883-8
Cleaner pin set 	-	197879-9

Outdoor Power Equipment

Gasoline filter, Spark plug & Air cleaner element



Model No.	Gasoline filter	Spark plug		Air cleaner element	
	Part No.	Type	Part No.	Type	Part No.
BHX2500, BHX2501	163447-0	NGK CMR6A	168401-9	PRE FILTER (Foam)	443141-3
				AIR FILTER (Non-woven fabric)	443140-5
EA3110T	-	NGK BPMR8Y	649500-1	-	MR00285584
EA3200S, EA3201S, EA3202S, EA3203S, EA3500S, EA3501S, EA3502S, EA3503S	163447-0	NGK CMR6A	168401-9	-	423414-0
EA3600F, EA3601F	163518-3	NGK BPMR8Y	649500-1	AIR FILTER (Nylon mesh)	126370-0
EA4300F, EA4301F	163447-0	NGK CMR7A-5	168599-2	AIR FILTER (Nylon mesh)	123452-9
				-	-
EA5000P, EA5001P	163499-1	NGK BPMR7A	168648-5 965603021	-	-
				-	-
EA5600F		NGK BPMR7A	168648-5 965603021	AIR FILTER (Paper)	131173010
EA6100P, EA6101P	163499-1	NGK BPMR7A	168648-5 965603021	-	-
EA7300P, EA7301P, EA7900P, EA7901P	163499-1	NGK BPMR7A	168648-5 965603021	AIR FILTER (Nylon mesh)	038173011
				AIR FILTER (Fleece)	038173101
EM2901LH/LHN/UH, EM2902LHN, EM2904LH/LHN, EM2905LHN, EB2901H, EB2902H	163518-3	NGK CMR6H	168652-4	-	-
EB5300TH/WH	163532-9	NGK CMR6H	168652-4	-	-
EB7650TH/WH	163532-9	NGK CMR6A	168401-9	-	-
EB7660TH/WH	163532-9	NGK CMR6H	168652-4	AIR FILTER (Fleece)	424809-0
EBH252U, EBH253U, EBH341L/U	163447-0	NGK CMR4A	168534-0	PRE FILTER (Foam)	443141-3
				AIR FILTER (Non-woven fabric)	443140-5
EBH340R/U EBH341R	163447-0	NGK CMR6A	168401-9	PRE FILTER (Foam)	443141-3
				AIR FILTER (Non-woven fabric)	443140-5
EE2650H, EM2510LH, EM2511LH, EM2550UH	163518-3	NGK CMR4A	168534-0	PRE FILTER (Foam)	443171-4
				AIR FILTER (Non-woven fabric)	443169-1
EF1550RH	163447-0	NGK CMR4A	168534-0	-	-
EH5000W, EH6000S/W, EH7500S/W	163518-3	NGK CMR6A	168401-9	PRE FILTER (Foam)	443157-8
				AIR FILTER (Non-woven fabric)	443158-6
EK6100, EK6101	163499-1	NGK BPMR7A	168648-5 965603021	AIR FILTER (Paper)	424789-0
				AIR FILTER (Nylon mesh)	424790-5
				-	-
EK7300, EK7301, EK8100	163499-1	NGK BPMR7A	168648-5 965603021	AIR FILTER (Paper)	424701-0
				AIR FILTER (Nylon mesh)	424705-2
EK7650H, EK7651H	163447-0	NGK CMR6H	168652-4	-	-
EK8110	163499-1	NGK BPMR7A	168648-5 965603021	-	-
EM2500L, EM2500U	-	NGK BPMR7A	168648-5 965603021	-	-
EM2510LH, EM2511LH, EM2550UH, ER2550LH	163447-0	NGK CMR4A	168534-0	PRE FILTER (Foam)	443141-3
				AIR FILTER (Non-woven fabric)	443140-5
EM2600L/U, ER2600L	-	NGK BPMR7A	168648-5 965603021	-	-
EM3400L/U	163447-0	NGK BPMR7A	168648-5 965603021	-	-
EM4350LH/RH/UH, EM4351UH	163518-3	NGK CMR6A	168401-9	PRE FILTER (Foam)	443196-8
				AIR FILTER (Paper)	442181-8
EN4950H, EN4951SH, EN5950S, EN7350S, ER2650LH, EX2650LH, EY2650H	163518-3	NGK CMR4A	168534-0	PRE FILTER (Foam)	443171-4
				AIR FILTER (Non-woven fabric)	443169-1
EVH2000	163447-0	NGK CMR6A	168401-9	-	-
EW1050H, EW1060H	163447-0	NGK CMR6A	168401-9	PRE FILTER (Foam)	443141-3
				AIR FILTER (Non-woven fabric)	443140-5
PE3450H	163447-0	NGK CMR6A	168401-9	PRE FILTER (Foam)	443171-4
				AIR FILTER (Non-woven fabric)	443169-1
PM7650H, PM7651H	163532-9	NGK CMR6A	168401-9	AIR FILTER (Paper)	442181-8
RBC411U, RBC412U	-	NGK BPMR7A / NGK BPM7A	168648-5 965603021 / 168588-7	PRE FILTER (Foam) Square	443162-5
				AIR FILTER (Foam) Round	443161-7
RBC413U, RBC414U	163447-0	NGK BPMR7A / NGK BPM7A	168648-5 965603021 / 168588-7	-	-

ACCESSORIES

▣ Cleaning / Vacuum System



Cordless Cleaner System charts

For Cleaning



Model
DVC340 / DVC350 /
DVC860L / DVC861L /
DVC862L / DVC863L



Model
DVC261 / DVC265

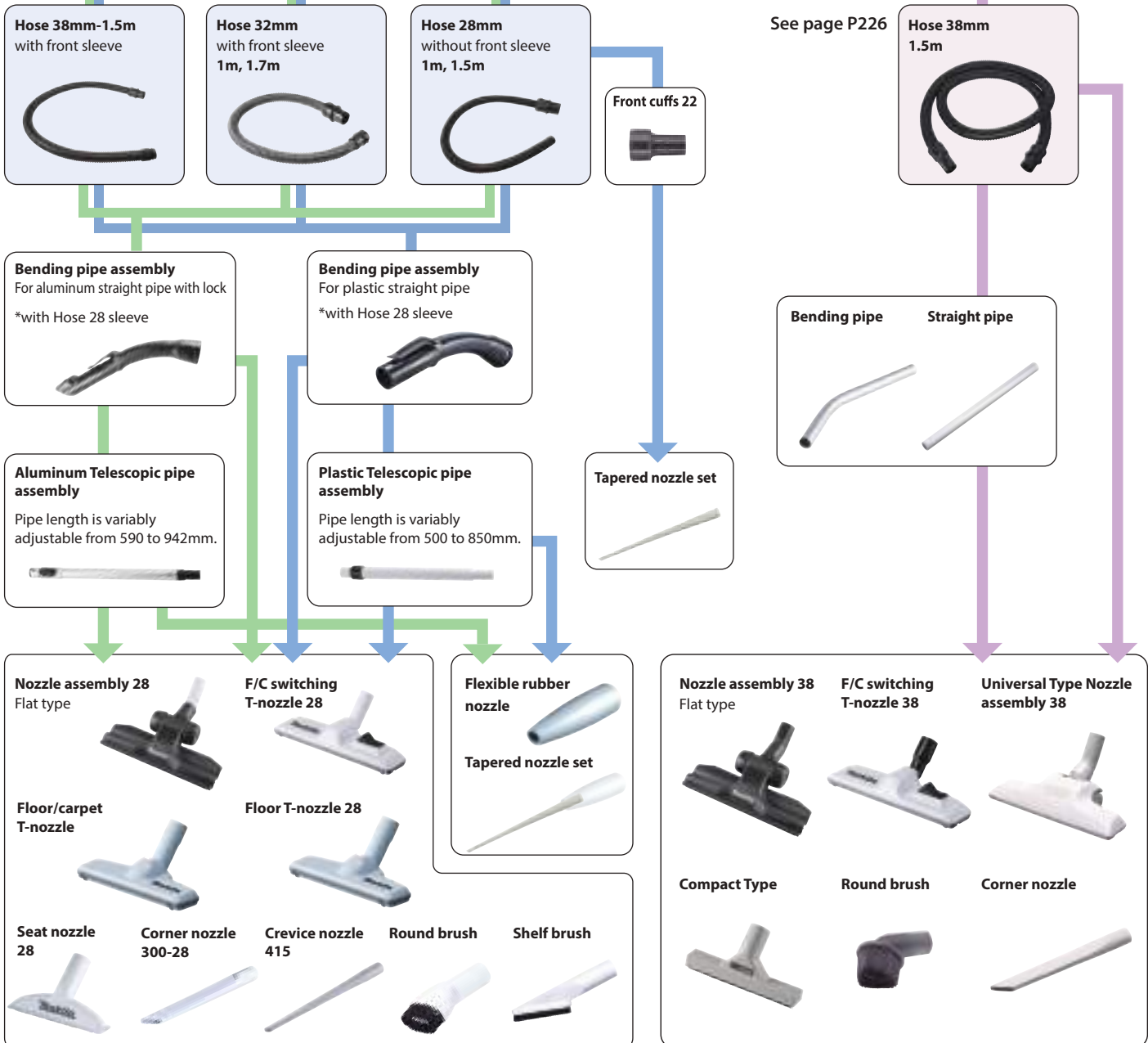

Cordless Cleaner System charts

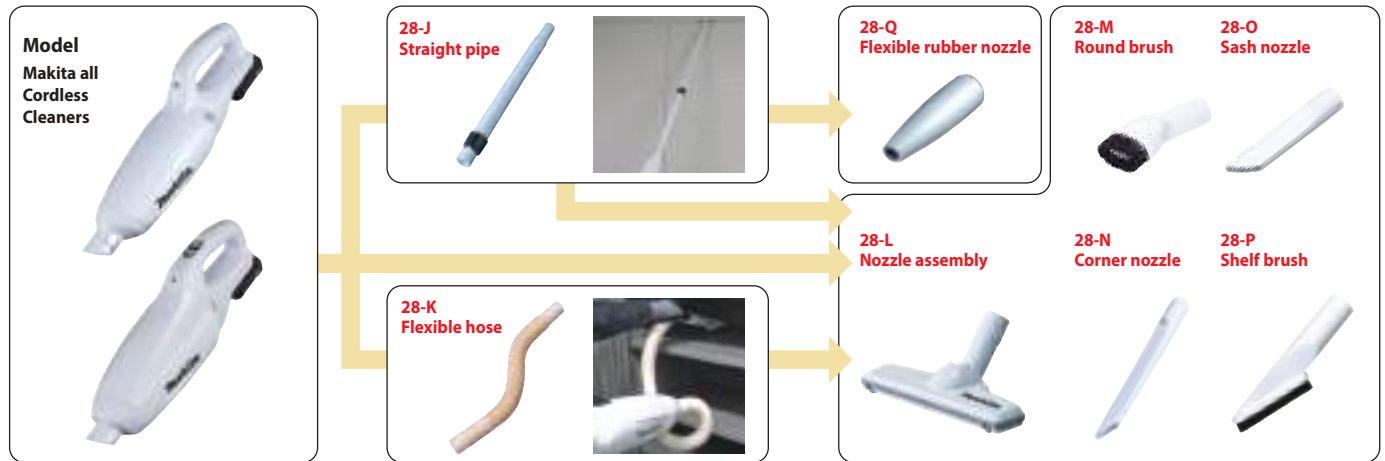

For Cordless Cleaner 28-J Straight pipe



Description	Color	Part No.
Telescopic pipe assembly 28 Pipe length is variably adjustable from 500 to 850mm.	White	123584-2
Pipe 28	Ivory	451424-7
	White	451241-5
	Blue	451244-9
	Red	451425-5
	Black	456587-4

Nozzle assembly Floor / carpet t-nozzle For rug / carpet cleaning



Description	Color	Part No.
Floor / carpet t-nozzle For rug / carpet cleaning	Ivory	A-59922
	White	A-59950
	Blue	198523-1
	Red	A-59938
	Black	198526-5

28-K Flexible hose set 28



Description	Color	Part No.
Flexible hose set 28 Superior in flexibility and for the cleaning of the small place in the car	Ivory	191496-7
	White	198867-9
	Blue	198541-9
	Red	198542-7
	Black	198543-5

Nozzle assembly Floor t-nozzle 28



28-L Nozzle assembly Flat type



Description	Color	Part No.
Flat type	Black	199454-7
F/C switching t-nozzle 28 Flooring & carpet	White	198183-9
F/C switching t-nozzle 38 Flooring & carpet	White	A-61335

Description	Color	Part No.
Floor t-nozzle 28	Ivory	123485-4
	White	123486-2
	Blue	123488-8
	Red	123489-6
	Black	123539-7

Cordless Cleaner System charts

Nozzle assembly

For rug / carpet cleaning



Description	Color	Part No.
For rug / carpet cleaning	Ivory	122291-4

Nozzle assembly

Seat nozzle 28



Description	Color	Part No.
Seat nozzle 28 For car seat	White	199037-3
	Blue	199040-4
	Black	198921-9

28-M Round brush 28



Color	Part No.
Ivory	198548-5
White	198877-6
Blue	198549-3
Red	198550-8
Black	198551-6



28-N Corner nozzle 300-28



Description	Color	Part No.
300-28mm	White	198918-8
	Blue	198989-5
	Black	198991-8

28-O

Sash nozzle 28 and Long Sash nozzle 415

Sash nozzle 28



Long sash nozzle 415



Description	Color	Part No.
Sash nozzle 28	Ivory	416041-0
	White	451240-7
	Blue	451243-1
	Red	416225-0
	Black	456586-6
Crevice nozzle 415 set	White	199439-3

28-P Shelf brush set28

(For gentle cleaning by soft-tipped brush)



Color	Part No.
Ivory	191724-0
White	198872-6
Blue	198534-6
Red	198535-4
Black	198536-2

28-Q Flexible rubber nozzle

Color	Part No.
Gray	197900-4



Cleaning / Vacuum System

Cordless Cleaner for Capsule type

For Model:
CL183D, DCL181F, DCL180, CL111D, CL106FD, CL070D

Filter



Pre filter



Easy shake off dust filter



Description	Per pkg.	Part No.
Filter	1	443060-3
Pre filter	1	451208-3
Easy shake off dust filter	1	455176-2



Cordless Cleaner for Paper bag type

For Model:
DCL182, CL107FD, CL105D, CL104D, CL072D

Paper filter



Dust bag



Easy shake off dust bag



Description	Per pkg.	Part No.
Paper filter	10	194565-3
Anti-bacterial type	5	194566-1
Dust bag	1	166043-3
Anti-bacterial type	1	166084-9
Easy shake off dust bag	1	198748-7

Other Cleaners For DVC260

Dust bag assembly



Filter bag set (Paper dust bag)



Description	Per pkg.	Part No.
Dust bag assembly	1	197898-5
Filter bag set (Paper dust bag)	10	197902-0

Cleaning / Vacuum System

For DRC200

Boundary line tape (15m roll)



Side brushes



Power brush



Turn brush cover



Filter



DUP361

Model No.	Part No.
Boundary line tape (15m roll)	SH00000231(EU)
Side brushes	SH00000065
Power brush	SH00000063
Turn brush cover	SH00000064
Filter	SH00000213

For DVC350

Dust bag

Part No.

122918-6



Nozzle assembly

A: Standard equipment



Model No.	Size(mm)	Type	Part No.
DVC350	220	A	132025-7
	430	-	134182-7

For DCL501



	Type	Part No.
Hose	-	SH00000034
Straight pipe	Adjustable length	SH00000060
Nozzle assembly	Flooring & carpet	SH00000058
Crevice nozzle	-	SH00000042



Cyclone attachment set

Color	Part No.
White	199491-1
Black	191D75-5







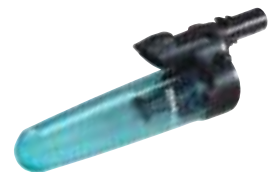



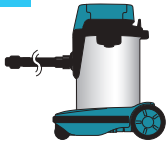
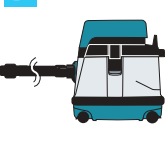



Cyclone attachment set with pipe lock







Color	Part No.
White	191D71-3
Black	191D73-9

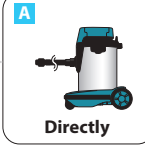
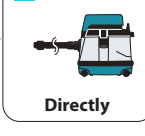

Cleaning / Vacuum System Chart

A	B	C	D	E	F	G
						
W/ Ø28mm Hose	W/ Ø28mm Hose	W/ Ø28mm Hose	W/ Ø38mm Hose	W/ Ø28mm Hose	W/ Ø32mm Hose	W/ Ø32mm Hose
Model VC3211H VC3211M VC2211M VC3210L	Model VC2510L VC1310L DVC861L DVC863L DVC864L	Model DVC350	Model DVC860L DVC861L DVC862L DVC863L DVC750	Model DVC261 DVC265	Model VC2012L VC2512L VC3011L	Model VC3012L VC4010L VC3012M VC4010M
W/ Front cuffs	W/ Front cuffs	W/ Front cuffs	W/ Joint 22-38	W/ Front cuffs	W/ Tool adapter Adapter 38 (option)	W/ Tool adapter
						
38 24 22	38 24 22	38 24 22		38 24 22	P-81745 P-70421	P-70378 W107418688

For Model	Suction Systems and Part No.
-----------	------------------------------

Rotary Hammer, Demolition Hammer SDS-MAX, 17mm (11/16") Hex: Bull points with over 280mm length Cold chisels with over 280mm length SDS-MAX only: Scaling chisel (for tile), Bushing tool Scaling chisels length 19mm (3/4") Hex only Scaling chisels 17mm (11/16") Hex: HM0830, HR3530, HR4030C SDS-MAX: HR4001C/02/10C/11C, HR4501C/10C/11C, HR3540C/41FC HM0870C/71C, HM1101C/11C, HM1203C/13C, HM1214C HR4501C/10C/11C, HR4013C HR4003C, HR3540C/41FC DHR400, HR5202C, HR5212C, HM1205 19mm (3/4") Hex: HR4041C	Dust extractor attachment set (Hammering mode only)  ø28mm hose can be directly connected.	
		Directly
		
		Directly
		
Directly		
		
ø28mm hose		
		
Directly		
		
Tool adapter 24		
		
Tool adapter 24		

For Model	Suction Systems and Part No.
-----------	------------------------------

Rotary Hammer, Combination Hammer DHR242, HR2300, HR2600 HR2601/F, HR2610, HR2611F, HR2630, HR2631F, HR2641, HR2650, HR2651, HR2661, DHR280, DHR282 DHR243, HR2320T, HR2610T HR2611FT, HR2630T, HR2631FT, HR2651T, DHR281, DHR283 BHR262, DHR164, DHR165, DHR171, DHR202, DHR241, DHR263, HR140D, HR166D, HR1840, HR1841F, HR1830, HR1830F, HR2230, HR2432, HR2460/F, HR2470/F, HR2475, HR2800, HR2810, HR2811F Rotary Hammer, Combination Hammer DHR164, DHR165 DHR202, BHR262/T DHR263, DHR264 HR2470 series HR2800 series	Dust cup set 195048-6  Dust extractor attachment 193472-7  Use with grip base set see page 32	
		Front cuffs 22
		
		Front cuffs 22
		
Front cuffs 22		
		
Joint 22-38 195548-6		
		
Front cuffs 22		
		
Tool adapter + Joint 25-50 192349-3		
		
Tool adapter 38 + Joint 22-38 195548-6		

Items of standard equipment and specifications may vary by country or area.

Cleaning / Vacuum System Chart

For Model	Suction Systems and Part No.
Angle Cutter 4112H 4112HS 4114 4114S	Elbow joint 32 192613-2
Dustless Cutter 4105KB	Elbow joint 32 192613-2
Dustless Cutter 4100KB	
Cutter With Dust Collection 4157KB	
Wall Chaser SG1251, SG1250	
Concrete Planer PC5000C, PC5001C	
Angle Grinder For 115, 125mm Model Single notch _____ w mark of origin 195237-3 Triple notches _____ w/o mark of origin for IEC 195239-9 w/ mark of origin for IEC 195238-1 North America package 195236-5 North America package for UL 196575-6 For 180,230mm Model w/ mark of origin for IEC 195384-0 w/o mark of origin for IEC 195385-8 North America package for UL 197584-8 Twin notches _____ w/ mark of origin 195387-4 w/o mark of origin 195388-2 North America package 195386-6	Dust collecting wheel guard For cup type diamond wheel



For Model	Suction Systems and Part No.
Angle Grinder For 125mm Model _____ 196845-3 196846-1 For 230mm Model _____ 198379-2 198380-7	Dust collecting wheel guard
Angle Grinder For 115, 125mm Model _____ 192968-5 193794-5 (Economy type) For 180mm Model _____ 194303-3 For 230mm Model _____ 194044-1	Dust collecting wheel guard
Belt Sander 9924DB	Joint 32 192518-6
Belt Sander 9404, 9902, 9903, 9910, 9911, 9920,	
Belt Sander 9403, 9921	Joint 32 192349-3
Wheel Sander 9741	Joint 410899-9











Items of standard equipment and specifications may vary by country or area.

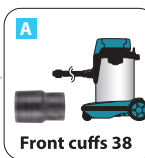
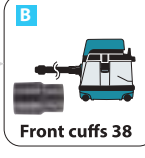







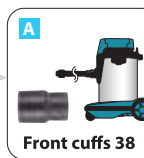
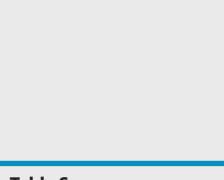
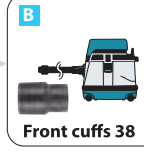

Cleaning / Vacuum System Chart

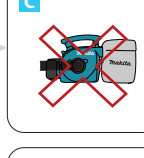
For Model	Suction Systems and Part No.	For Model	Suction Systems and Part No.
Disc Grinder N9500N, 9500NB 	Dust collecting wheel guard 192212-0  Rubber sleeve 192202-3	Belt Sander 9031 	front cuffs24 195546-0 
Angle Grinder For 100mm Model  For 115,125mm Model 	Dust collecting wheel guard Dust collecting 100C set — 198413-8 Dust collecting 100CD set — 198414-6 	Circular Saw HS6100, HS6101, HS7100, HS7101 DHS710, HS6600, HS6601, HS7010, HS7600, HS7601, HS7610, HS7611 HS6600, HS7000, HS7600, DHS711 HS0600 DHS680 HS7000, HS7600	Joint (Dust nozzle) 453289-3 196520-1 196843-7 (with short lever) 198263-1 198265-7 (with short lever) 196961-1 196952-2 (with short lever) 196520-1 197221-4 (with short lever)
Belt Sander 9032 	Dust nozzle assembly 122652-8 	Plunge Cut Circular Saw SP6000 	front cuffs 22       
Belt Sander 9031 Finishing Sander 9046, BO3700, BO3710, BO3711, BO4900/V, BO4901, BO4555, BO4556, BO4565, BO4566, BO4557, BO4558   	Dust attachment set DTM50, DTM40 — 195965-0 TM3000C — 196022-7 TM3010C — 196550-2  DTM51, DTM41 — 196765-1 	Aluminum Groove Cutter CA5000 	front cuffs 24 195546-0 
Multi Tool DTM50, DTM40 — 195965-0 TM3000C — 196022-7 TM3010C — 196550-2  DTM51, DTM41 — 196765-1 	Dust attachment set DTM50, DTM40 — 195965-0 TM3000C — 196022-7 TM3010C — 196550-2  DTM51, DTM41 — 196765-1 	Cordless Plunge Cut Circular Saw DSP600, DSP601 	front cuffs 24 195546-0 
Circular Saw DHS630 — 194314-8 DSS611, DSS610 — 419283-5 DSS501, DSS500 — 194415-2 HS300D, HS301D — 195334-5 	Joint (Dust nozzle) 194314-8 419283-5 194415-2 195334-5 	Cordless Jig Saw DJV141, DJV142 — 126331-0 DJV181, DJV182 — 457801-1 DJV102D, JV103D — 457801-1 	Dust nozzle assembly 126331-0 457801-1  Front cuffs 24 195546-0 
Jig Saw JV100D, JV143D, JV183D 4326, 4327, 4328, 4329, JV0600 	Joint (Dust nozzle) 194314-8 419283-5 194415-2 195334-5 	Slide Compound Saw LS1019/L, LS1219/L 	Front cuffs 24 195546-0 
Jig Saw DJV140, DJV180 4350T/CT/FCT, 4351T/CT/FCT 	Dust Nozzle 417853-4 	Cordless Slide Compound Miter Saw DLS110, DLS111, DLS112 	Front cuffs 24 195546-0 

Items of standard equipment and specifications may vary by country or area.

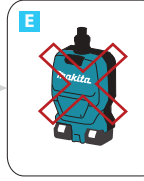
Cleaning / Vacuum System Chart







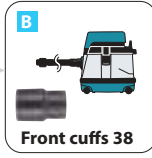

For Model	Suction Systems and Part No.
Cordless Slide Compound Miter Saw DLS713 DLS714	 <p>A Front cuffs 38</p>
Slide Compound Saw LS0714/F/FL/L LS0815F/FL LS1016L LS1017L LS1018/L LS1216/L	 <p>B Front cuffs 38</p>
Miter Saw LS1030N, LS1440	 <p>C Front cuffs 38</p>
	 <p>D</p>
Compound Miter Saw LS1040/F, LS1045, LS1221	 <p>E</p>
Cordless Compound Miter Saw DLS600	 <p>F Adapter 38</p>
Flip Over Saw LF1000	 <p>G Tool adapter 38</p>
Table Top Miter Saw LH1040/F LH1201FL	 <p>G Tool adapter 38</p>

For Model	Suction Systems and Part No.
Table Saw 2704, 2705	Joint 419093-0
	 <p>A Front cuffs 38</p>
Table Saw 2703	Joint 55 192799-2
	 <p>B Front cuffs 38</p>
Table Saw MLT100	Dust point JM27000090
	 <p>C</p>
Table Saw 2712	Dust point JM27000090
	 <p>D</p>
Band Saw LB1200F	Joint 419093-0
	 <p>E</p>
Band Saw LB1200F	Joint 419093-0
	 <p>F Adapter 38</p>
Band Saw LB1200F	Joint 419093-0
	 <p>G Tool adapter 38</p>



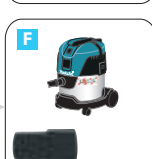













Items of standard equipment and specifications may vary by country or area.

Cleaning / Vacuum System Chart

For Model	Suction Systems and Part No.
Circular Saw 5603R, 5704R, 5705R — 192420-3 5143R — 192490-2 5008MG — 450079-5 194489-3 (with short lever) 5103R, 5903R — 192419-8 5104S, 5104 — 450316-7 N5900B, 5902B — 193823-9 193068-4 (with short lever)	 <p>A Front cuffs 38</p>  <p>B Front cuffs 38</p>  <p>C* Front cuffs 38</p>  <p>D Front cuffs 38</p>  <p>E Front cuffs 38</p>  <p>F Adapter 38</p>  <p>G Tool adapter 38</p>
Circular Saw 5604R, 5037NB	 <p>D Front cuffs 38</p>
Dustless Circular Saw 5017RKB 5057KB	 <p>G Tool adapter 38</p>

***C: DVC350, DVC340 Cannot be used with Planer models**

For Model	Suction Systems and Part No.
Power Planer 1050D, 1051D KP0810/C	 <p>A Front cuffs 38</p>  <p>B Front cuffs 38</p>  <p>C* Front cuffs 38</p>  <p>D Front cuffs 38</p>  <p>E Front cuffs 38</p>  <p>F Adapter 38</p>  <p>G Tool adapter 38</p>
Power Planer DKP180, DKP140 KP0800	Nozzle 451329-1
1805N — JPA122277	 <p>D Front cuffs 38</p>
Power Planer 1911B	Nozzle for vacuum cleaner 192082-7
 <p>E Front cuffs 38</p>  <p>F Adapter 38</p>  <p>G Tool adapter 38</p>	 <p>E Front cuffs 38</p>  <p>F Adapter 38</p>  <p>G Tool adapter 38</p>
Power Planer N1900B, N1923B, KP0800, 1804N 1805N, 1806B, KP312/S	 <p>G Tool adapter 38</p>

***C: DVC350, DVC340 Cannot be used with Planer models**



Nozzle assembly







Joint
*Elbow









Model No.	Part No.	Model No.	Part No.
N1900B, N1923B	181572-5	N1900B, N1923B	JPA122275
KP0800, DKP180, DKP140	451329-1	DKP180, DKP140, KP0810/ C, KP0800	*416368-8
1804N	JPA122278		
1805N	JPA122277		
1806B	122397-8	1804N, 1805N, 1806B, KP312/S	181575-9
KP312/S	193733-5		

Items of standard equipment and specifications may vary by country or area.

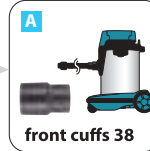
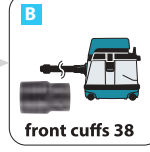
Cleaning / Vacuum System Chart

For Model	Suction Systems and Part No.
Plate Joiner PJ7000, 3901, DPJ180, DPJ140, DPJ181	 front cuffs 22
Cut-out Tool 3706	 front cuffs 22
Dust collection cover 193449-2	 front cuffs 22
Cordless Cut-out Tool DCO180	 Joint 22-38 195548-6
Cordless Drywall saw DSD180, SD100D	 front cuffs 22
Router RP0910, RP1110C	 Tool adapter 24 + Joint 25-50 192349-3
	 Tool adapter 38 + Joint 22-38 195548-6

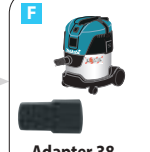
*C: DVC350 Cannot be used with Router models

For Model	Suction Systems and Part No.
Router RP1801/F RP1800/F RP2301FC RP2300FC	Dust nozzle 194934-8
 front cuffs 38	 front cuffs 38
Router RD1100, RD1101, RF1100, RF1101, RP1100, RP1101	Dust nozzle 193379-7
 front cuffs 38	
Router RP0900, ***RT0700C, DRT50	Dust nozzle 194733-8
Cordless Router DRT50	 front cuffs 38
*** Use with Plunge base assembly	 Adapter 38
Trimmer RT0700C	Dust nozzle 195559-1
Cordless Trimmer DRT50	 Tool adapter 38

Makita recommend to use 38mm hose when you use Router or Power planer.



Items of standard equipment and specifications may vary by country or area.

Vacuum Cleaner System Charts

For Cleaning

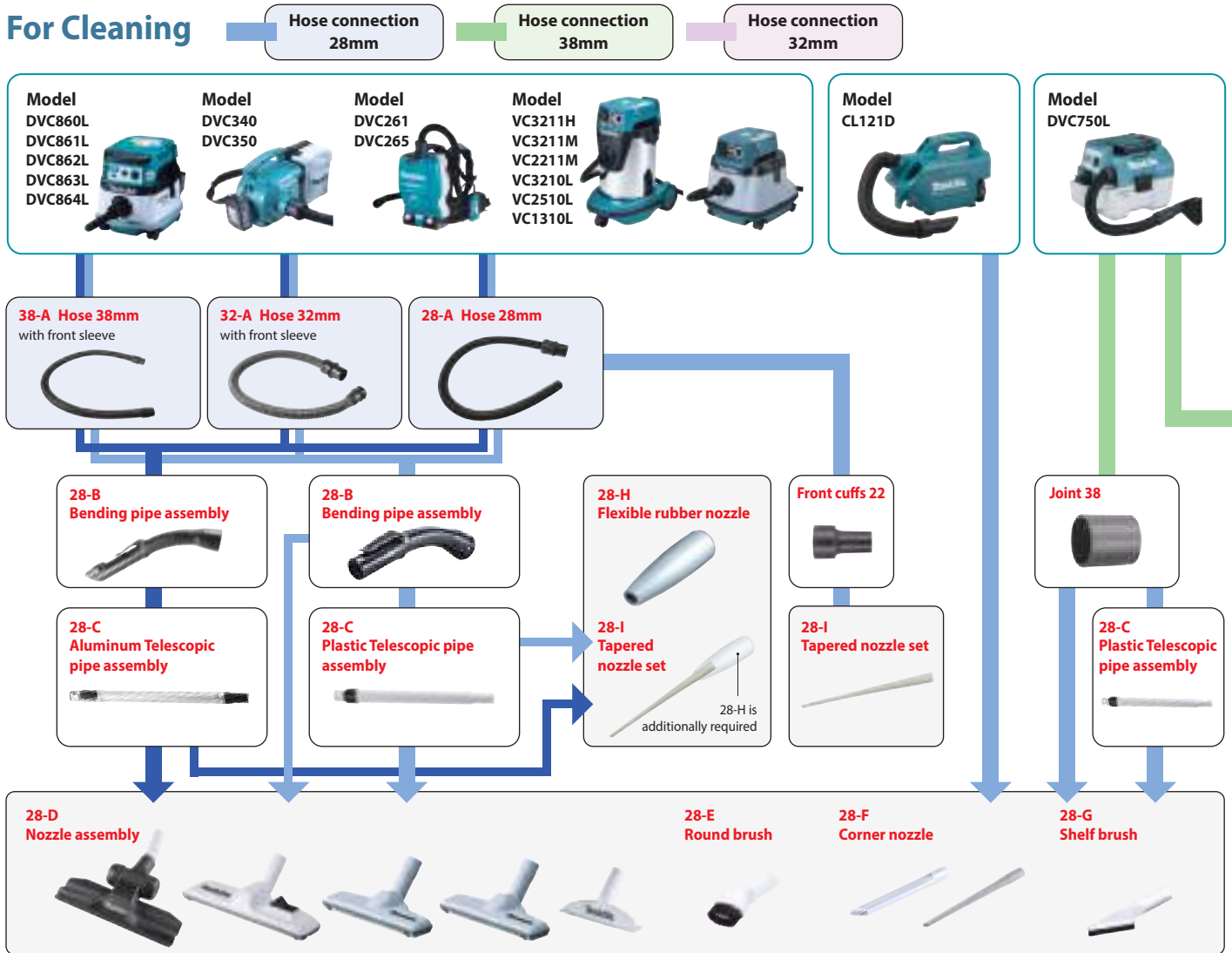

For Dust Collecting

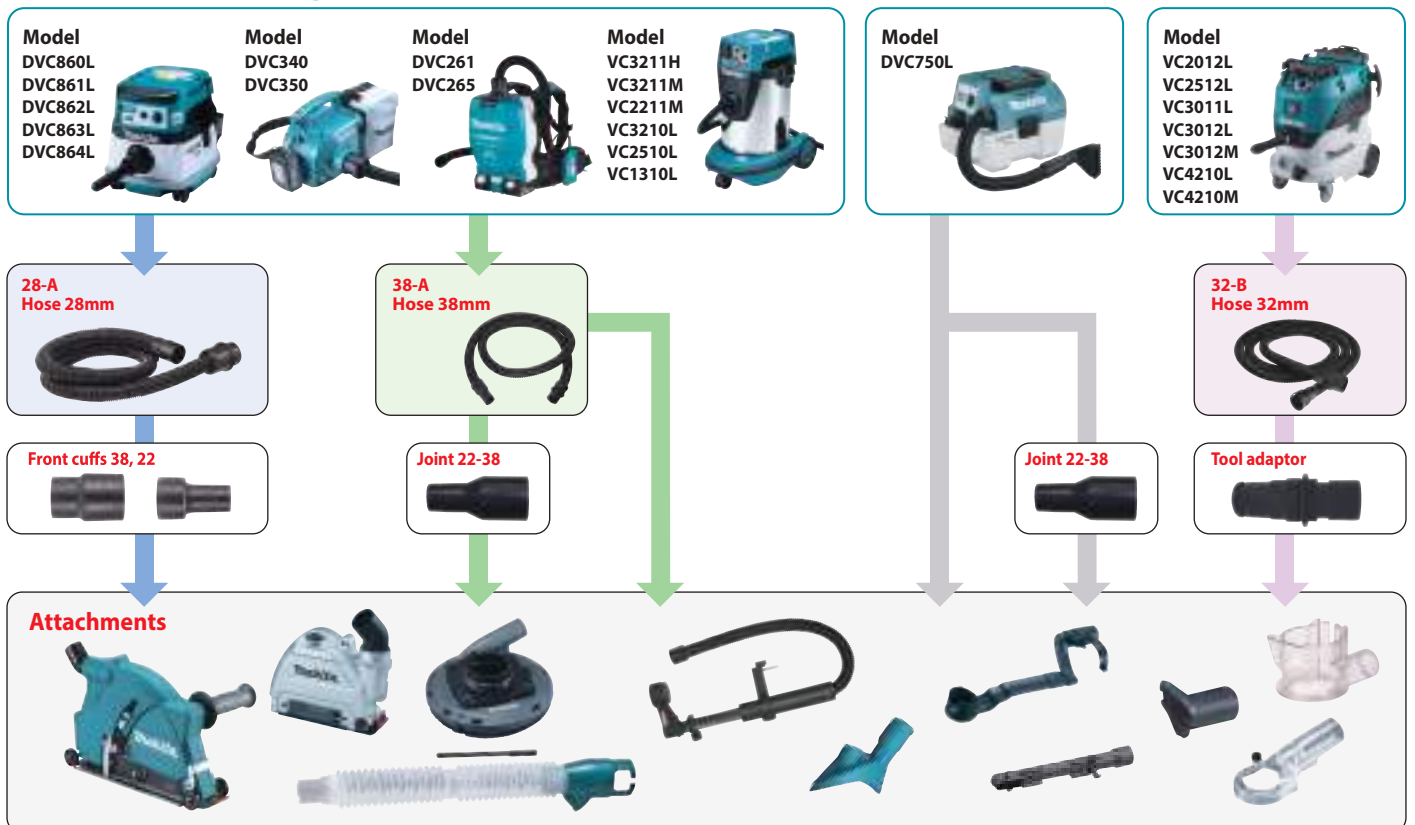

Vacuum Cleaner System Charts

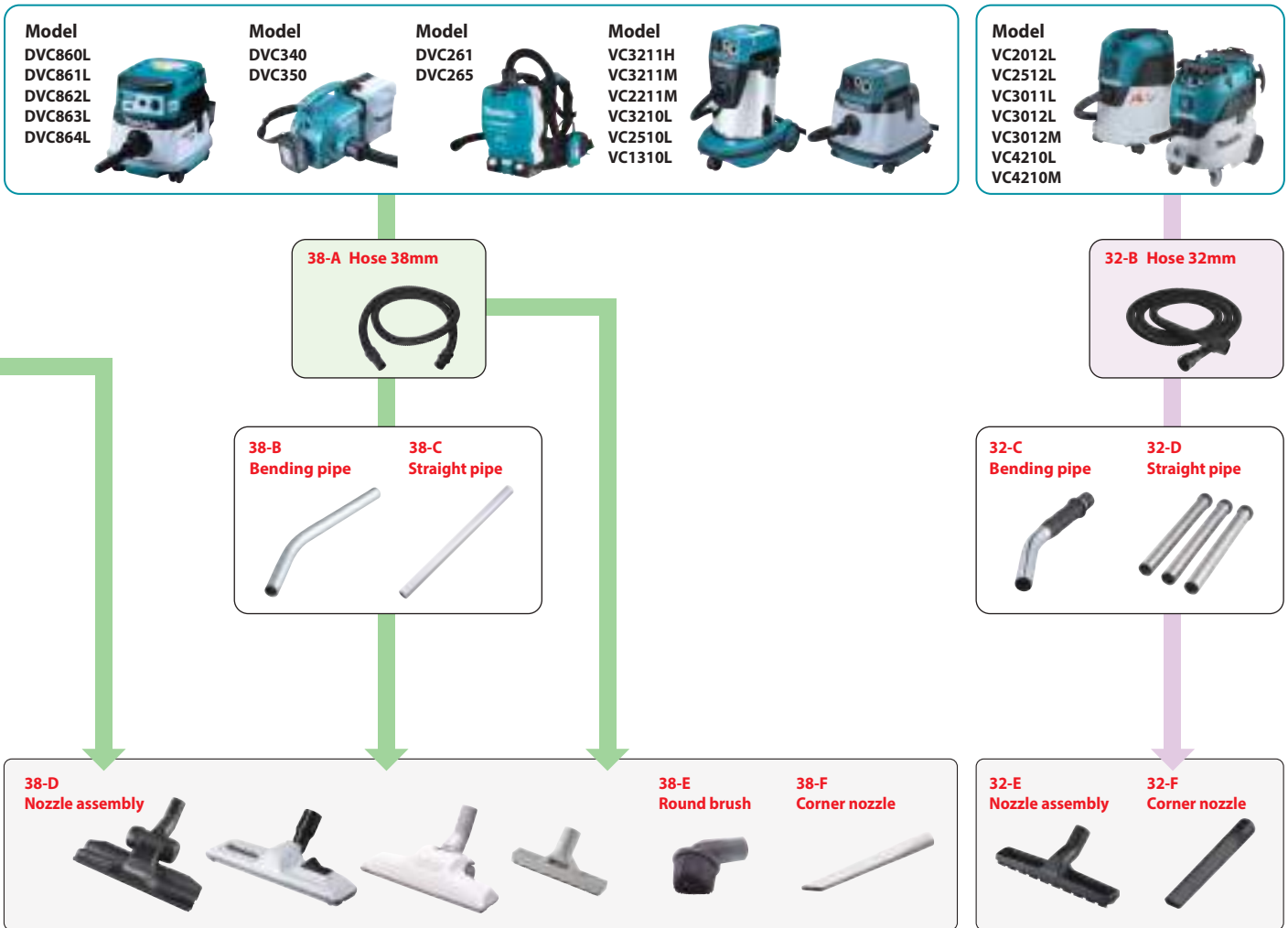

Front cuffs, Joint & Hose Connection

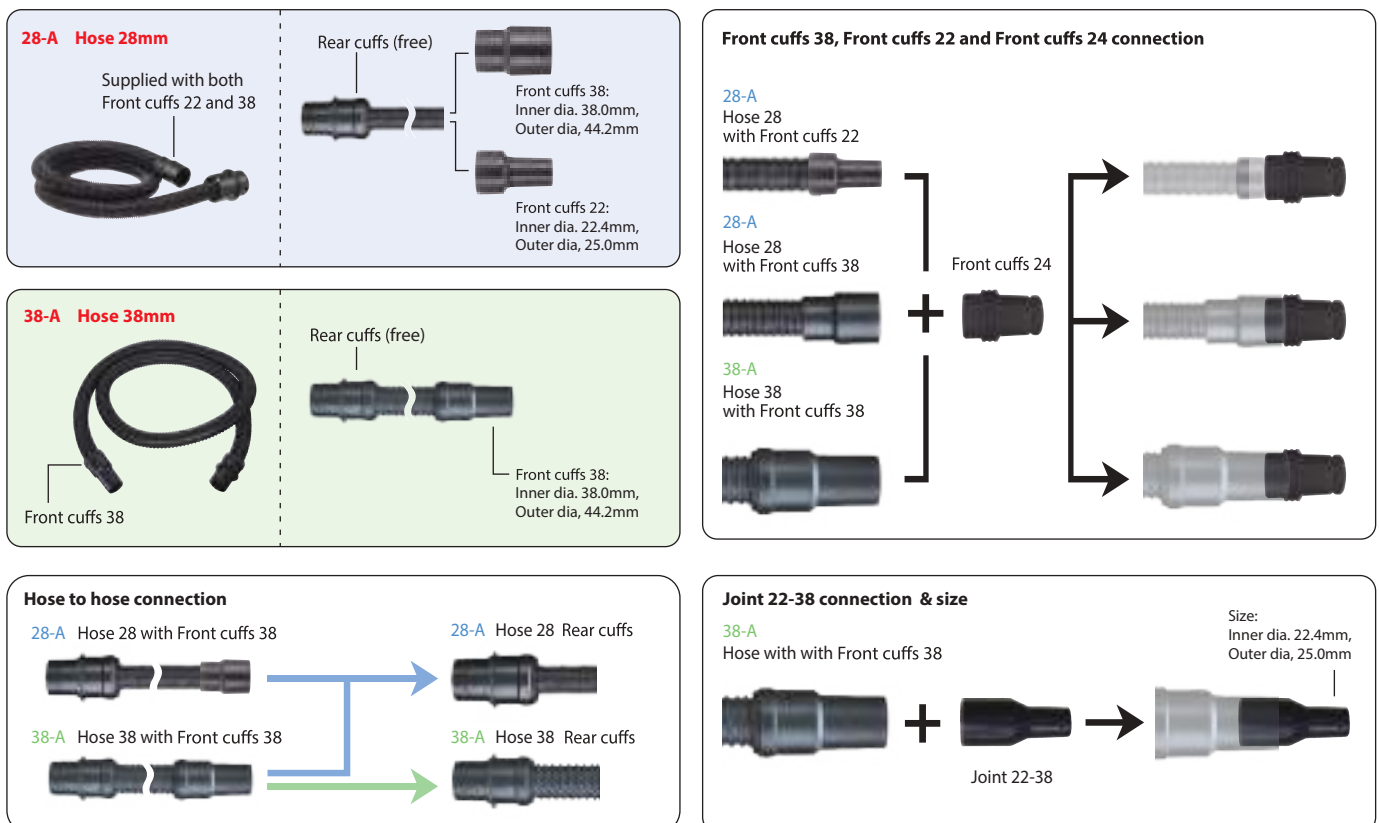

Cleaning / Vacuum System

Front cuffs & Joint

Front cuffs 22



Front cuffs 24



Front cuffs 38



Joint 22-38



Joint 38



Joint H



Rubber sleeve 18-21



Type	Part No.
Front cuffs 22	195547-8
Front cuffs 24	195546-0
Front cuffs 38	195545-2
Joint 22-38	195548-6
Joint 38	418500-0
Joint H	424009-2
Rubber sleeve 18-21	192202-3

Hose connection 28mm

28-A

Hose

Note:

Can be connected with power tools, Front cuffs and Joint are required for some power tools.

*DVC260, DVC261, DVC265 only

*for cleaning (Use with Bending pipe assembly)



Size	Length (m)	with Front cuffs	Part No.
28mm	1.0	-	*143787-2
28mm	1.5	38	*152992-0
28mm	1.5	22, 38	A-34235
28mm	2.5	22, 24, 38	195437-5
28mm	3.5	22, 24, 38	195433-3

Hose connection 32mm

32-A

Hose 32mm

for cleaning

Use with 28-B Bending pipe assembly



Size	Length (m)	with Front cuffs	Part No.
32mm	1.0	Sleeve	199453-9
32mm	1.7	Sleeve	199493-7

28-B

Bending pipe

*with Hose 28 sleeve



Description	Part No.
For Aluminum (Part No. 140G19-0) Telescopic pipe assembly with lock	140G26-3
	*127093-3
For plastic straight pipe 28 and Telescopic pipe assembly 28	458184-2
	*126756-8
with 38mm hose	123677-5

28-C

Straight pipe



Description	Part No.
Aluminum Telescopic pipe assembly Pipe length is variably adjustable from 590 to 942mm.	140G19-0
Telescopic pipe assembly 28 Pipe length is variably adjustable from 500 to 850mm.	123584-2

28-D

Nozzle assembly

Flat type



F/C switching t-nozzle 28
Flooring & carpet



Floor/carpet t-nozzle
For rug / carpet cleaning



For rug / carpet cleaning



Floor t-nozzle 28



Seat nozzle 28
For car seat

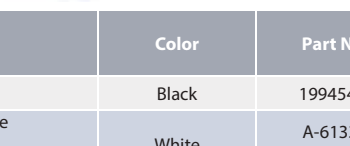

Description	Color	Part No.
Flat type	Black	199454-7
F/C switching t-nozzle 28 Flooring & carpet	White	A-61335 198183-9
	White	198525-7
Floor/carpet t-nozzle For rug / carpet cleaning	Black	198526-5
	Ivory	122291-4
Floor t-nozzle 28	White	123486-2
Seat nozzle 28 For car seat	White	199037-3
	Black	198921-9

Cleaning / Vacuum System

28-E Round Brush



Colour	Part No.
White	198877-6
Black	198551-6

28-F Corner nozzle

Type	Color	Part No.
300-28mm	White	198918-8
	Black	198991-8
Crevice nozzle 415 set	White	199439-3

28-G Shelf Brush

(For gentle cleaning by soft-tipped brush)



Colour	Part No.
White	198872-6
Black	198536-2

28-H Flexible Rubber Nozzle



Colour	Part No.
White	197900-4

28-I Tapered nozzle set

Use with Front cutts 22 or Flexible rubber nozzle



Colour	Part No.
Gray	192236-6

Hose Stand

For model VC2510L



Part No.
197323-6

Holder set 10-33



Part No.
195544-4

Holder cuff set



Components	Part No.
Holder 10-33, Front cuff 24, Front cuff 22	195637-7

For DVC750L

Filter Complete, Pre Filter and Damper

*(Dry use only)

*Pre filter



*Damper



*Pre filter and Damper set



Filter complete (HEPA filter)
(Standard equipment)



Shoulder Belt Set



Item	Part No.
Pre filter	162635-6
Damper	422449-8
Pre filter and Damper set	199827-4
Filter complete (HEPA filter)	162518-0
Shoulder Belt Set	162523-7

Cleaning / Vacuum System

Hose connection 38mm

38-A

Hose 38mm

for cleaning

*Use with 28-B Bending pipe assembly



Size	Length (m)	with Front cuffs	Part No.
38mm	1.5	-	*199388-4
38mm	1.5	38	198757-6
38mm	2.5	38	195434-1

Cleaning set

Includes one each:
 -Hose complete 38-2.5
 -Straight pipe
 -Bending pipe
 -Nozzle assembly
 -Corner nozzle



Part No.
195439-1

38-B Bending Pipe



Description	Part No.
Aluminum	192562-3

38-C Straight Pipe



Description	Part No.
Aluminum	192563-1

38-D

Nozzle assembly

Flat type



Flooring & carpet



Universal Type



Compact Type A



Compact Type B
(wet model only)



Wide Type
(wet model only)



Description	Dry/ Wet	Part No.
Flat type	Dry	199455-5
Flooring & carpet	Dry	198184-7
Universal Type	Dry/ Wet	195551-7
Compact Type A	Dry	195549-4
Compact Type B	Wet	195550-9
Wide Type	Wet	A-47846

38-E Round Brush



Description	Dry/Wet	Part No.
38mm	Black	191657-9

38-F Corner nozzle



Type	Color	Part No.
38mm	Yellow gray	410306-2

For DCL501



	Type	Part No.
Hose	-	SH00000034
Straight pipe	Adjustable length	SH00000060
Nozzle assembly	Flooring & carpet	SH00000058
Crevice nozzle	-	SH00000042

Filter & Dust Bag



for Dust
(Powder)































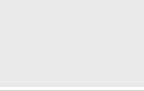
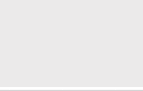
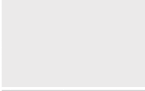
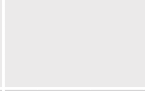
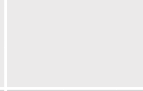
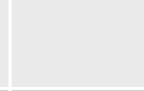

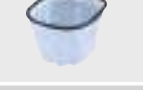
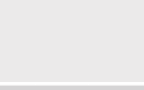
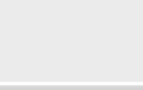
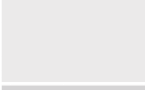
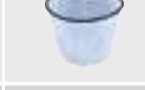
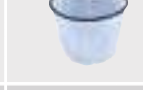

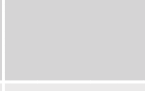
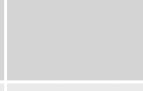
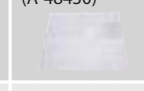
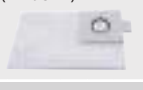

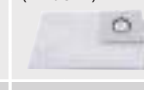
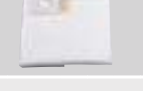

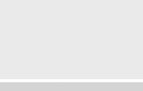
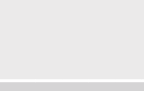
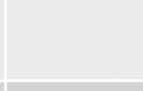
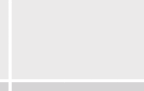
- Powder Filter Set
- Damper set
- Pre-filter set
- Dust paper filter or Poly bag set

Compatible with usual Poly bags or Paper filters, allowing for:



- Quick and easy dust disposal
- Lower-running cost compared with paper dust bag



	DVC862L DVC860L	DVC864L DVC863L DVC861L	VC3211H	VC3211M VC2211M VC2201M	VC3210L	VC2510L	VC1310L
	 (Wet & Dry)	 (Dry)	 (Wet & Dry)	 (Wet & Dry)	 (Wet & Dry)	 (Wet & Dry)	 (Wet & Dry)
Powder Filter Set Dry only	*197166-6 	*197166-6 	196251-2 	196252-0 	195441-4 	195441-4 	195438-3 
*HEPA filter							
Pre-filter set	195553-3 	195553-3 	196253-8 	196253-8 	195612-3 	195554-1 	195553-3 
Cloth filter	140248-3 						
Damper set	195552-5 	195552-5 	196254-6 	196254-6 	195552-5 	195552-5 	195552-5 
Filter for water set Water only	195555-9 				195611-5 	195556-7 	195555-9 
Paper filter set (5pcs) for dry dust except powder	194556-4 (A-48430) 	194556-4 (A-48430) 					194556-4 (A-48430) 
Dust paper filter 7L (5pcs) for dry powder	194719-2 (A-49541) 	194719-2 (A-49541) 					194719-2 (A-49541) 
Filter bag set 15L (5pcs) for dry dust	195557-5 	195557-5 				195557-5 	195557-5 
Filter bag set 25L (5pcs) for dry dust			195558-3 	195558-3 	195558-3 		
Poly bag set (10pcs)	195432-5 	195432-5 	195440-6 	195440-6 	195440-6 	195440-6 	195432-5 

Items of standard equipment and specifications may vary by country or area.

Cleaning / Vacuum System

Vacuum attachment

SDS-max 40/45mm class vacuum attachment



Model No.	Part No.
HR4011C, HR4010C, HR4001C, HR4511C, HR4510C, HR4501C, HR4002	195866-2
HR5212C, HR5202C	196858-4
DHR400, HR4003C, HR4013C	196536-6

Vacuum attachment

Hammering only
ø28mm hose can be directly connected.



Model No.	Shank size	Part No.
HM0830/T, HM0870C, HM0871C, HM1101C, HM1111C, HM1201, HM1203C, HM1205C, HM1213C, HM1214C, HR3530, HR3540C, HR3541FC, HR4001C, HR4002, HR4003C, HR4010C, HR4011C, HR4013C, HR4030C, HR4041C, HR4501C, HR4510C, HR4511C, HR5212C, HR5202C	With Vacuum hose set	196571-4

Dust case

With filter



Dust extraction system set	Part No.
DX01, DX02	195896-3
DX05	199595-9
HR2650, HR2651, HR2651T, HR2661	198982-9
DX06, DX07, DX08, DX09, HR2652, HR2653, HR2653T, HR2663	199586-0

Filter

HEPA Filter



Dust extraction system set	Part No.
DX01, DX02	195855-7
HR2650, HR2651, HR2651T, HR2661	196165-5
DX05	199596-7
DX06, DX07, DX08, DX09, HR2652, HR2653, HR2653T, HR2663	199557-7

Sealing cap

For Dust extraction system set
DX01, DX02, DX05, DX06, DX07, DX08, DX09, HR2650, HR2651, HR2652, HR2653, HR2651T, HR2653T, HR2661, HR2663



Part No.
424474-5

Fitting Rubber

For Dust extraction system set
DX01, DX02, DX05, DX06, DX07, DX08, DX09, HR2650, HR2651, HR2652, HR2653, HR2651T, HR2653T, HR2661, HR2663



Part No.
424722-2

Dust extraction system set

This system is designed to collect dust effectively with on off operation of the tool's on-off trigger switch interlocked with this system.



DC models

Model No.	Dust Extraction System	Part No.
DHR242	DX01	195896-3
DHR243	DX02	195902-4
HR182D	DX05	199658-1
DHR280 / DHR282	DX08	199579-7
DHR281 / DHR283	DX09	199583-6

ACCESSORIES

▣ Miscellaneous



Miscellaneous

Tape measure



Makita tape measure is highly durable and convenient. When the scales are blurred or hook is lost, that would be the end of its life. This measure is for professional which has a special coated tape, hook protector and damper which absorbs shocks leads to great durability.



■ Feature

1. Special Coating

* "DURA COAT" makes 5 times more durable

* "SILICA COAT" makes easier note



2. High durability of Hook

* Installed damper absorbs the shock on the hook

* Hook protector reduces the shock on the hook

* Tightly fixed hook with "4rivets+protector"

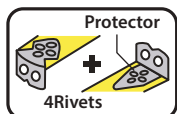

3. Convenience

* 2-sided print

* Hook with magnet

* "Matte finish" makes easier to read scales

* Standout



■ Printed size

mm



cm



Inch



cm/Inch



New!!

Tape measure with holder & safety cord



A safety cord prevents measure from falling which prevents an accident such as dropping a measure from high work sight. Actually, there was a fatal accident caused by the drop of measure.



Measure is attachable with a single touch. Press down the yellow lever and take off the measure.



Miscellaneous

Tape measure

Makita tape measure is highly durable and convenient. When the scales are blurred or hook is lost, that would be the end of its life. This measure is for professional having a special coated tape and hook protector's damper absorbing shocks to have great durability.



Color of tape

Yellow



Printed size

mm



Inch



mm/Inc



Feature

1. Coating



DURA COAT

To increase its durability, applied nylon extrusion coating on tapes. DURA COAT is 5 times more durable than common acrylic coating.



SILICA COAT

10m tape measure applied SILICA COAT on it. It's not durable as DURA COAT, but it's more durable than a common acrylic coating. Its surface is easy to make a note by a pencil. For example, you can make out a check on a frequently checking scale.

2. 2-Sided



Tape measure is bendable so it can be used in various ways. It is convenient with scales on back side also.

3. Matte Finish



With matte finish, it is easy to read scales even under the sun.

4. 4Rivets+Protector



To keep the hook on the tape longer, it is designed as 4 rivets on the front side and protector on the back side of the tape.



5. Magnet



Applied strong neodymium magnet.

6. Shock absorb



Installed a damper to absorb shock on a hook when retracting a tape and avoid losing a hook.

7. Hook protector



To reduce the shock on hook when a measure is fallen, installed hook protector at both sides of hook. It protect the hook.

8. Standout



It is one of the important points the length of tapes which can be kept straight. It can be kept straight 1.3m with 3.5m measure, 2.4m with 5.5/7.5m measure and 2.2m with 10m measure.

Miscellaneous

Tape measure

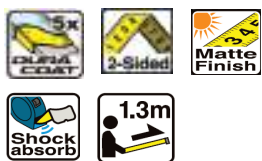

Size	Length	Width	Part No.
mm	3.5m	16mm	B-57130



Size	Length	Width	Part No.
mm/inch	5.5m/18ft	25mm/1"	B-57211
	7.5m/25ft	25mm/1"	B-57227



Size	Length	Width	Part No.
mm	10m	25mm	B-57168

Tape measure with holder & safety cord



Size	Length	Width	Part No.
mm/inch	7.5m/25ft	25mm/1"	B-68351

Screw driver



Size	Length (mm)	Part No.	
+	PH1	100	B-65903
	PH2	100	B-65919
	PH3	150	B-65931
*	PZ1	80	B-65947
	PZ2	100	B-65953
	PZ3	150	B-65969
*	T10	100	B-65975
	T15	100	B-65981
	T20	100	B-65997
	T25	100	B-66008
	T30	100	B-66014
-	SL4.0	100	B-66020
	SL5.5	100	B-66036
	SL6.5	125	B-66042
	SL8	150	B-66058

Go thru Screw driver



Size	Length (mm)	Part No.	
+	PH1	75	B-66064
	PH2	100	B-66070
	PH3	150	B-66086
*	PZ1	75	B-66092
	PZ2	100	B-66101
	PZ3	150	B-66117

Shock driver



Size	Length (mm)	Part No.	
+	PH2	125	B-42438
	PH3	150	B-42444
*	PZ2	125	B-42450
	PZ3	150	B-42466











Ratchet screwdriver

With screw bit 25mm (PH2)x1 pcs.

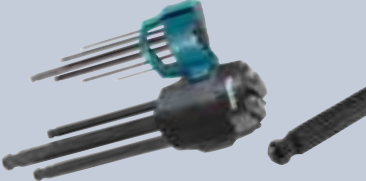

Part No.
D-58833

Miscellaneous

Hand Tool	Application
<p>Adjustable wrench</p> 	 <p>Wide excursion jaw allows each tool to work with even more fastener sizes.</p>
	<p>Open end</p>  <p>U-shaped opening grips with two opposite face of the bolts and nuts. Due to the opening, it can easily access to bolts and nut.</p>
<p>Spanner</p>	<p>Flare end</p>   <p>Narrow opening which is wide enough to fit over the tube. Large contact surface with fastener reduces rounding. Suitable for aluminum, copper and brass hexagonal fittings on oil pipe.</p>
	<p>Box end</p>   <p>Enclosed opening grips snugly fits the faces of the bolts and nuts. Force can be applied to bolts or nuts with decreased chance of damaging.</p>
<p>Ratcheting wrench</p> 	 <p>The ratcheting mechanism allows fastener to be tightened or loosened without disconnecting the tool from it. It makes the works more rapidly.</p>
<p>Hex key wrench with ball-end</p> 	 <p>Used for tightening or loosening cap screw and bolts with hexagonal sockets attached to their heads. A ball end allows the tool to be used at an angle off-axis to screw and bolt. It means it can be used at tightening area.</p>



Miscellaneous

40 pcs. Ratcheting Tap & die set

Small/ Medium Ratcheting T wrench, Small Tap adapter, Medium Tap adapter
 Medium Hex die adapter, Screw driver, Pitch gauge,
 NC Hex die: 3mmx0.50, 3mmx0.60, 4mmx0.70, 4mmx0.75, 5mmx0.80, 5mmx0.90,
 6mmx1.00, 7mmx1.00, 8mmx1.25, 9mmx1.25, 10mmx1.50, 11mmx1.50, 12mmx1.75
 NC Plug Tap: 8mmx1.25, 9mmx1.25, 10mmx1.50, 11mmx1.50, 12mmx1.25
 NC Taper Tap: 3mmx0.50, 3mmx0.60, 4mmx0.70,
 4mmx0.75, 5mmx0.80, 5mmx0.90, 6mmx1.00, 7mmx1.00
 NF Hex Die: 9mmx1.00, 10mmx1.5, 12mmx1.50
 NF Plug Tap: 9mmx1.00, 10mmx1.25, 12mmx1.50
 BSP Hex Die: 1/8-28, BSP Tap 1/8-28



Part No.
B-65838

Ratcheting tap & die handle



Part No.
B-65866

Tap adapter



Part No.
B-65872

Twist lock die adapter



Part No.
B-65888

Ratchet & socket set



Drive	Contents	Sum	Part No.
1/4" SQ	84T Ratchet, bit adapter, Slide T bar, Socket: 4, 4.5, 5, 5.5, 6, 7, 8, 9, 10, 11, 12, 13mm, Deep socket: 5, 6, 7, 8, 9, 10, 11, 12, 13mm, Extension bar: 3", 6", T bit: T8, T10, T15, T20, T25, T27, T30, T40x25mm	34	B-65567
3/8" SQ	84T Ratchet, Adapter to 1/2" SQ, Socket: 8, 9, 10, 11, 12, 13, 14, 15, 16, 17, 18, 19, 20mm, Middle socket: 8, 10, 13, 16, 17, 19mm, Extension bar: 3", 6"	23	B-65573
1/2" SQ	84T Ratchet, Adapter to 3/8" SQ, Universal joint, Socket: 10, 11, 12, 13, 14, 15, 16, 17, 18, 19, 20, 21, 22, 23, 24, 27, 30, 32mm, Extension bar: 5", 10"	23	B-65589

Pass thru socket set



Contents	Sum	Part No.
Pass thru Socket: 10, 11, 12, 13, 14, 15, 16, 17, 18, 19mm, Socket adapter: 1/4", 3/8", Pass thru Extension bar: 75mm, Ratchet handle (Pass thru handle straight)	14	B-65595
Pass thru Socket: 10, 11, 12, 13, 14, 15, 16, 17, 18, 19mm, Pass thru Socket: 3/8", 7/16", 1/2", 9/16", 5/8", 11/16", 3/4", Socket adapter: 1/4", 3/8", Pass thru Extension bar: 75mm, Ratchet handle (Pass thru handle straight)	21	B-65604

Pass thru extension bar



Part No.
B-65632

Socket adapter



Size	Part No.
1/4"	B-65844
3/8"	B-65850

Locking flex pass thru handle



Part No.
B-65626

Pass thru handle straight



Part No.
B-65610

Pass thru socket



Size	Part No.	Size	Part No.
10mm	B-65648	15mm	B-65698
11mm	B-65654	16mm	B-65707
12mm	B-65660	17mm	B-65713
13mm	B-65676	18mm	B-65729
14mm	B-65682	19mm	B-65735

Miscellaneous

Retractable utility knife



Part No.
B-65785

Quick change Folding utility knife



Part No.
B-65501

Spare blade 10 pcs. set



Part No.
B-65517

Snap-off knife



Part No.
D-58855



Part No.
D-65713

Box joint water pump pliers



Overall length	MAX Jaw size	Part No.
7"(180mm)	37mm	B-65741
9.5"(240mm)	49mm	B-65757
12"(300mm)	68mm	B-65763

Water pump pliers



Overall length	MAX Jaw size	Part No.
10"(250mm)	51mm	B-65486
12"(300mm)	76mm	B-65492

Smooth face claw hammer



Overall length	Size	Part No.
250mm	20OZ. (0.57kg)	B-65779

Aviation snip



Description	Cutting capacity		Part No.
	Cold-rolled steel	Stainless steel	
Cuts straight	18ga (1.22mm)	23ga (0.61mm)	B-65791
Cuts left			B-65800
Cuts right			B-65816
Bull dog			B-65822

Adjustable wrench



Length	Capacity	Part No.
6"(150mm)	29mm	B-65414
8"(200mm)	36mm	B-65420
10"(250mm)	38mm	B-65436
12"(300mm)	43mm	B-65442

11 pcs. Pass thru adjustable wrench set



Description	Size	Part No.
Adjustable wrench	200mm	B-65458
3/8" socket	3/8"(10mm), 7/16"(11mm), 15/32"(12mm), 1/2"(13mm), 9/16"(14mm), 19/32"(15mm), 5/8"(16mm), 11/16"(17mm), 23/32"(18mm), 3/4"(19mm)	

Locking adjustable wrench



Size	MAX Jaw size	Part No.
10"(250mm)	35mm	B-65470

Miscellaneous

Combination wrench 9pcs. set



Size	Part No.
8, 10, 12, 13, 14, 15, 16, 17, 18mm	B-65539

Double box wrench 5pcs. set



Size	Part No.
8x9, 10x11, 12x13, 14x15, 18x19mm	B-65551

Flare nut wrench 5pcs. set



Size	Part No.
9x11, 10x12, 13x14, 15x17, 16x18mm	B-65545

Double ratchet wrench 8pcs. set



Size	Part No.
8, 10, 12, 13, 14, 15, 17, 19mm	B-65523

Hex key wrench 9pcs. set



Size	Part No.
1.5, 2, 2.5, 3, 4, 5, 6, 8, 10mm	B-65894

Guide rail bag



Size	Part No.
1,000mm	B-66905
1,400/1,500mm	B-57613

Joint Plastic Case



Type	Size (mm)	Part No.
Small	105 x 395 x 295	821549-5
Medium	158 x 395 x 295	821550-0
Large	210 x 395 x 295	821551-8
Extra Large	316 x 395 x 295	821552-6

Trolley

Part No.
TR00000002



Image is for reference only

Cart

Part No.
P-83886



Tray

Part No.
P-83652



Part No.
P-83674



Miscellaneous

Heat Gun Accessories



Type	For Model	Part No.	Ref.
1	HG5012, HG551V, HG651C	119.350	P-71417
2		134.412	P-71423
3		134.414	P-71445
4	HG551V, HG651C	134.413	P-71439
5	HG651C	134.418	P-71489
6		134.415	P-71451
7		134.420	P-71504

Heat Gun Accessories for HG6031V, HG5030

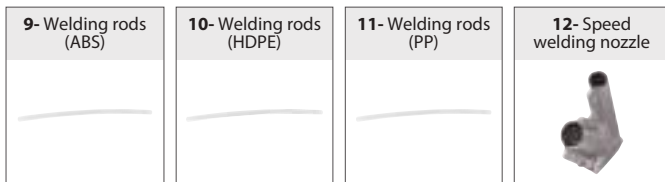
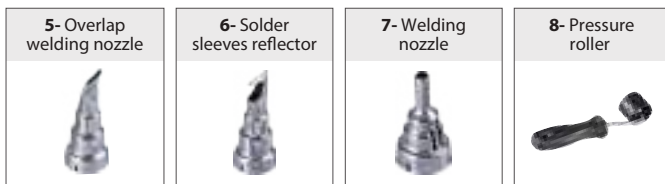
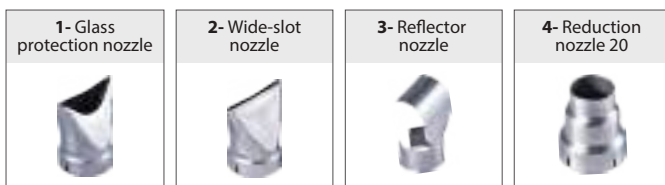

Type	Part No.
1	PR0000028
2	PR0000029
3	PR0000030
4	PR0000031
5	PR0000032
6	PR0000033
7	PR0000034
8	PR0000035
9	PR0000036
10	PR0000037
11	PR0000038
12	PR0000039
13	PR0000040
14	PR0000041

Miscellaneous

Flat Tape Collated Screws

50pcs screws/belt, 1,000pcs screws/box
 *Sorted by the strength for corrosion resistance
 Drywall Screws





L (mm)	Shank Dia (mm)	Head Dia (mm)	Recess	Thread	Finish	For Model								Part No.
						DFR440	DFR540	DFR550	DFR750	6842	6843	6844	6845	
						25- 41mm	25- 55mm	25- 55mm	45- 75mm	25- 55mm	25- 55mm	45- 75mm	25- 41mm	
41	3.9	8.2	PH2	Coarse	Yellow Zinc (5 micron)	0	0	0		0	0		0	F-32216
25	3.9	8.2	PH2	Fine	Phosphated	0	0	0		0	0		0	F-30913
35	3.9	8.2	PH2	Fine	Phosphated	0	0	0		0	0		0	F-31153
55	3.9	8.2	PH2	Fine	Phosphated	0	0	0	0	0	0		0	F-30942

Mixing blade

For Model: UT1305
 Stainless steel Shaft (Part No.: A-43751)



Mixing Blade				Bolt	
Type	Bolt	Twin blade possible	Part No.	Bolt Size	Part No.
 Mixing Blade 130	Sold separate	-	A-43670	M8 x 18	265220-5
 Mixing Blade 150	-	-	A-43686	M8 x 25	-
 Mixing Blade 165	Sold separate	-	A-43692	M8 x 18	265220-5

For Model: UT2204
 Stainless steel Shaft (Part No.: A-43773)

Mixing Blade				Bolt	
Type	Bolt	Twin blade	Part No.	Bolt Size	Part No.
 Mixing Blade 135	-	-	A-43723	W5/16 x 16	-

Miscellaneous

Reber binding attachment set with 1/4" Hex. shank



Region A
Part No.
194731-2

Hex wrench



Model No.	Size	Part No.
JN1601, 2012NB	2.5mm	783208-8
JN3200, JS1600, JS1660, JS1670, 4331D, 4333D, 4334D, 4300BA, 4300BV, 4326/M, 4327/M, 4328, 4329, JV0600	3mm	783201-2
JS3200, 4350T/CT/FCT, 4351T/CT/FCT, DJV140, DJV180, 1806B, N1923B, 1911B	4mm	783202-0
JS1300	5/32"	783215-1

Keyless drill chuck



* North & South America

Package type	Bulk
Part No.	Part No.

For Model:
6013B/BR, 6300-4, 6310, DP4700

192892-2	-
----------	---

For Model:
6261D, 6271D, 6281D, BDF343

-	766002-3
---	----------

For Model:
6319D, 6339D, 6349D, 8414D, 8434D, 8444D, DDF454, DHP454

-	*763191-5
-	763199-9

For Model:
6381D, 6391D, 8381D, 8391D, DDF445, DDF453, DDF452, DF457D, DHP453, HP457D

-	766027-7
---	----------

For Model:
6408, 6402, 6510LVR, DA302D, DA391D, DA392D, DA312D, DA3011/F

192016-0	763132-1
----------	----------

Tie wire set



Model No.	Per pkg.	Part No.
DTR180	50	199137-9

Keyless drill chuck

* North & South America

Package type	Bulk
Part No.	Part No.

For Model:
6413

-	763180-0
---	----------

For Model:
8271D, 8281D, DHP343, HP330D, HP331DS

-	763229-6
---	----------

For Model:
DDA341, DDA351

-	766005-7
---	----------

For Model:
DDF441, DDF451, DHP441, DHP451, DDF444, DDF454, DHP444, DHP454

-	*763191-5
-	763196-5

For Model:
BDF460, BHP460

193064-2	-
----------	---

For Model:
DP4001, DP4003

192956-2	-
----------	---

For Model:
HP2051/F, HP2071/F

194254-0	-
----------	---

For Model:
DF330D, DF331D

-	763228-8
---	----------

For Model:
DDF446, DDF456, DHP456, DDF482, DHP482

-	766027-7
---	----------

For Model:
DF332D, HP332D

-	763238-5
---	----------

Coffee Maker accessories

For model:
DCM501
Cup cover



Part No.
KF00000021

Cup



Part No.
KF00000020

Filter



Part No.
KF00000013

Spoon



Part No.
KF00000033

Miscellaneous

Drill chuck



*Europe **North & South America

Drill chuck		Chuck key
Package type	Bulk	Bulk
Part No.	Part No.	Part No.

For Model:
6010D, 6409

192970-8	-	763418-3
----------	---	----------

For Model:
DP2010

192887-5	763077-3	763418-3
----------	----------	----------

For Model:
6013B/BR, 6300-4, 6301, 6305, 8406/C, 8416, DP4700, HP2010N

192877-8	-	763432-9
----------	---	----------

For Model:
6304LR, DA4000LR

193318-7	-	763432-9
----------	---	----------

For Model:
6501

192887-5	763077-3	763418-3
----------	----------	----------

For Model:
DA3010/F, DDA340, DDA350

-	763174-5	763415-9
---	----------	----------

For Model:
DP3002

-	-	763434-5
---	---	----------

For Model:
DA4030, DA4031

-	-	763432-9
---	---	----------

For Model:
DA4000LR, DS4000

**193319-5	-	763434-5
------------	---	----------

For Model:
DP4000, DP4002

-	-	763434-5
---	---	----------

For Model:
DP4010, HP2050, HP2051

193067-6	-	-
----------	---	---

For Model:
HP1620/F

192541-1	763142-8	-
----------	----------	---

For Model:
HP2050/F, HP2070/F, HP2071/F

*193822-6	-	763430-3
-----------	---	----------

193067-6	-	763430-3
----------	---	----------

For Model:
HP1630

195081-8	763161-4	763441-8
----------	----------	----------

For Model: DS4012

-	-	763430-3
---	---	----------

Carbon brush



High Volt CB No.	Part No.	Low Volt CB No.	Part No.
1	181019-9	1	181019-9
51	181021-2	76	191947-0
55	181026-2	75	191956-9
64	191627-8	75	191956-9
65	191628-6	76	191947-0
70	191914-5	70	191914-5
85	191998-3	75	191956-9
100	181030-1	124	191945-4
106	181410-1	107	181437-1
132	191972-1	132	191972-1
153	181044-0	154	181047-4
154	181047-4	154	181047-4
165	191936-5	166	191968-2
203	191953-5	203	191953-5
253	194547-5	253	194547-5
303	191963-2	303	191963-2
-	-	311	191979-7
325	194074-2	325	194074-2
411	191940-4	408	191938-1
415	191950-1	401	191910-3
419	191962-4	407	191927-6
459	194722-3	458	194721-5

Auto Cut- out Carbon Brush

105	181038-5	105	181038-5
113	191904-8	113	191904-8
155	181048-2	155	181048-2
173	195483-8	172	195100-0
175	195844-2	175	195844-2
204	191957-7	204	191957-7
327	194285-9	304	191961-6
318	191978-9	318	191978-9
350	194160-9	350	194160-9

Carbon Brush for Cordless tool

424	191966-6	424	191966-6
430	191971-3	430	191971-3
434	193466-2	434	193466-2
440	194427-5	440	194427-5
441	194435-6	441	194435-6
442	194928-3	442	194928-3
448	196854-2	448	196854-2

Miscellaneous

Drill chuck assembly



Type	Part No.
For Impact Driver	
Connect Bit 6.35-48 Keyless NZ	192121-3
Connect Bit 6.35-48 NZ	192173-4
Connect Bit 6.35-48 NZ	191880-6

Adjustable locator set with bit

For Model:
DTD130F, DTD133, DTD134, DTD140, DTD141, DTD142, DTD145, DTD146, DTP130, DTP140, DSTS130, 6916FD, 6935FD, 6936FD, 6980FD, TD0100, TD0101, TD0101F

*with E-form Bit (MZ), **without Bit



Part No.
**194280-9

Straight head, Angle head, Angle wrench head, Ratchet head



Straight head



Angle head



Angle wrench head



Ratchet



For Model:
DTL060, DTL061, DTL062, DTL063, TL064D, TL065D

Description	Type	Part No.
Straight head	NZ	192440-7
Angle head	-	135183-8
Angle wrench head	9.5mm (3/8")	135201-2
Ratchet head	-	192439-2

Shoulder Strap

For Model:
DSC102



Part No.
199069-0

Ratchet head adapter (Socket, Socket adapter)

use with Ratchet head

Socket

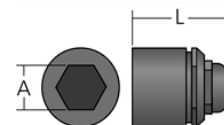

Socket adapter



For Model:
DTL060, DTL061, DTL062, DTL063, TL064D, TL065D

Description	Type	Part No.
Socket	17 x 31 (A x L)	134743-3
	19 x 33 (A x L)	134744-1
Socket adapter	9.5mm (3/8")	134745-9
	12.7mm (1/2")	134746-7

Rubber pad assembly

(Use with wool bonnet)



Part No.
123001-2

Wool bonnet

100mm (3-15/16") dia.
(Use with rubber pad for polishing and buffing)



Part No.
794173-6

Grease gun attachment

Part No.
T-01797



Grease Hose (optional)

Size	Part No.
12"	T-01812
18"	T-01828
24"	T-01834
48"	T-03274



Miscellaneous

Foam polishing pad

125mm (4-7/8") dia.
(For polishing glass, etc.)



Part No.
794159-0

Guide rule

(Rip fence)



Model No.	Part No.
4191D, 5093D, 5094D, DSS501, DSS500, DSS610, DSS611, DCS550, HS300D	164095-8
DSP600, DSP601	165447-6

Holder set

A: 300ml size Holder



B: 600ml size Holder



C: 800ml size Holder



Model No.	Type	Part No.
DCG180, DCG140, CG100D	A	196351-8
	B	196352-6
	C	197195-9



Shear blade (L)



Model No.	Part No.
DUP361	197367-6(EU)

Shear blade (U)



Model No.	Part No.
DUP361	197366-8

Diamond file



Model No.	Part No.
DUP361	794530-8

Blade

For CP100D



Model No.	For Material	Part No.
CP100D	-	198604-1

Shoulder strap for carrying case



Part No.
166070-0

Depth gauge

(Stopper pole)



Model No.	Part No.
BDF460, DHP441, DHP451, DHP444, DHP454, BHP460,	122576-8
Rotary hammer & Combination Hammer	
DHR165, HR166D	415486-9
DHR202, DHR241, DHR242, DHR243, BHR262, BHR262T, DHR263, DHR264, HR262D, HR262TD	324219-0
DHR280, DHR281, DHR282, DHR283	321248-4

Miscellaneous

Dustcup set & Grip base set

*Standard equipment
Dustcup set
Photo:
198362-9



Grip base set
with Spacer assembly, Hex. bolt and grip base
Photo:
194583-1



Model No.	Dustcup Set	Grip Base Set
	Part No.	Part No.
HR1840, HR1841F, DHR165, HR166D	198362-9	194581-5
HR2230, HR2460/F		194583-1
HR2470/F, HR2475, BHR262, DHR263, HR262D, DHR202, DHR241		194582-3

Bulb

(2 pcs. / set)



* For North America

Model No.	Voltage	Part No.
DML184	14.4V,18V	B-07303

Battery protector



For Battery	Part No.
BL1430B, BL1440, BL1450, BL1460B, BL1830B, BL1840B, BL1850B	194649-7

Battery protector

Designed to protect the battery cartridge from dust and dripping water in outdoor applications or harsh environments.



Model No.	For Battery	Part No.
DTD146, DTD147, DTD148, DTS141, DDF458, DHP458	BL1815N, BL1820, BL1830B, BL1840B, BL1850B, BL1860B	195798-3

Battery adapter & Battery converter

BAP36N



BCV01



BCV03



BAP182



Adapter BL36120A-18Vx2



Model No.	Voltage	Part No.
BAP36N	36V Model	195311-7
BCV01	36V Model	195511-9
BAP182	18Vx2 Model	197581-4
BL36120A	18Vx2 Model	-

Portable Battery Checker

Except CXT battery, G(L) battery, BL3622A, BL36120A
Checking time: within 5sec.



Part No.
198038-8

Miscellaneous

Angle attachment

(For drilling in close quarters, incorners, between joists and studs).



Description	Type	Part No.
DS4010, DS4011, DS4012	High: 800rpm Low: 350rpm	STEX122177
DA4000LR	High: 900rpm Low: 400rpm	193316-1

Extension attachment



Model No.	Part No.
DA4000LR	193317-9

Type 43 drill stand

For Neck diameter 43mm Models



Part No.
A-36712

Extension bar

(With pin and O ring)
For narrow places

* Cordless Impact Wrench

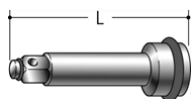

Model No.	Size	L (mm)	Part No.
* 6953, 6904VH, 6905B, 6905H, TW0200, TW0350	1/2"	100	134874-8
6910, TW1000	1"	200	134870-6

Universal joint

(With pin and O ring)

For use in tight areas where the tool cannot be

* Cordless Impact Wrench

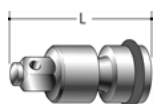

Model No.	Size	L (mm)	Part No.
* 6953, 6904VH, 6905B, 6905H, TW0200, TW0350	1/2"	84	134877-2

Bit adapter assembly

(With pin and O ring)

* Cordless Impact Wrench

(exclude Model DTW450, DTW1002)



Model No.	Size	Part No.
* 6904VH, 6953, TW0200	1/2"	134873-0

Grip assembly

Model No.	Part No.
6906	122464-9
TW1000	122727-3



Extension handle



Model No.	Part No.
6841R, 6842, 6843, 6844, 6845, DFR440, DFR540, DFR550, DFR750	194500-1

Sleeve size reference table

For Model:

6922NB



*Type F

Sleeve	Bolt Size	L (mm)	Part No.
Outer sleeve			
Outer sleeve	M16	35	764362-7
Outer sleeve	M20	37	764361-9
Outer sleeve	M22	39	153909-6
Outer sleeve	M22,7/8"	85	764364-3
Outer sleeve	5/8"	35	764362-7
Outer sleeve	3/4"	37	764361-9
Outer sleeve	3/4"	83	764363-5
Inner sleeve			
Inner sleeve	M16	36	764416-0
			*764421-7
Inner sleeve	M20	38	764417-8
			*764422-5
Inner sleeve	M22,7/8"	39	764418-6
			*764423-3
Inner sleeve	M22,7/8"	85	764352-0
Inner sleeve	5/8"	36	764420-9
Inner sleeve	3/4"	38	764419-4
Inner sleeve	3/4"	84	764353-8

For Model:

6924N

Outer sleeve	M22	49	194033-6
Outer sleeve	7/8"	49	194092-0
Outer sleeve	M24,1"	49	194034-4
Inner sleeve	M22,7/8"	48	194310-6
Inner sleeve	1"	49	194312-2
Inner sleeve	M24	49	194311-4

Miscellaneous

for Drywall Screwdrivers

For Model: FS2500, FS6300, FS6300R, FS4300, FS2300, FS6200, FS4200, FS2200, DFS440, DFS441, DFS450, DFS451, DFS452

Phillips insert bit



Size	Per pkg.	Part No.
Ph 2-25	3	798398-4
Ph 3-25	3	798314-6

Front Cap



Model No.	Size	Per pkg.	Part No.	
FS2700	Phillips bit	12	322070-2	
	Socket bit	15.5	322069-7	
	L=50mm bit	-	322120-3	
	Magnetic socket bit	1/4"		322124-5
		5/16"		322125-3
3/8"			322119-8	

Phillips bit

For Model: FS2700
N Type



Size	L (mm)	Type	Per pkg.	Part No.
No.2	45	NZ	3	798308-1
No.2	45	NZ-Hard	1	784229-3
No.3	45	NZ	3	798310-4

Socket bit

For Model: FS2700
*For self drilling screw
**Magnetic socket bit

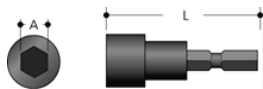

Bolt Size	A (mm)	L (mm)	Type	Part No.
M5	8	55	NZ	784403-3
1/4"	3/8"	55	NZ	**784809-5
M6	10	55	NZ	784405-9

Magnetic socket bit

For Model: FS2700
DIN, E Form, M Type

*Non-magnetic socket bit



Bolt Size	A (mm)	L (mm)	Type	Part No.
L=50mm bit				
Magnetic bit holder + C Form (L=25mm)				
3/16"	5/16"	65	MZ	784804-5
M5	8mm	65	MZ	*784415-6
1/4"	3/8"	65	MZ	784802-9
M6	10mm	65	MZ	784806-1

Magnetic socket bit

For Model: FS2500, FS2701



*Non-magnetic socket bit

Bolt Size	A (mm)	L (mm)	Type	Part No.
1/8"	1/4"	65	MZ	784803-7
3/16"	5/16"	65	MZ	784804-5
M5	8mm	65	MZ	*784415-6
1/4"	3/8"	65	MZ	784802-9
M6	10mm	65	MZ	784806-1
1/2"	7/16"	65	MZ	784805-3
1/2"	7/16"	65	MZ	*784414-8



Miscellaneous

Dust cup

(Dust collector assembly)
(Protects operator from dust and debris)



Bit Dia. (mm)	Part No.
6-14.5	421342-3
12-16	421664-1

Ground rod adapter

(For driving ground rods)



Model No.	Shank size	Part No.
HM0810B	19mm Hex	798132-2

Quick change drill chuck set (13mm)



AC models

*Keyless Chuck with locking device (Rohm SUPER SK)

Model No.	Part No.
HR2310T, HR2320T, HR2470FT /T, HR2610T, HR2611FT, HR2630T, HR2631FT, HR2651T, HR2810T, HR2811FT	194079-2
HR3210FCT	194568-7

Cordless models

BHR262T DHR243 DHR264 HR262TD	194079-2
-------------------------------	----------

Tool holder set



AC models

Model No.	Part No.
HR2310T, HR2320T, HR2470FT /T, HR2610T, HR2611FT, HR2630T, HR2631FT, HR2651T, HR2810T, HR2811FT	194080-7
HR3210FCT	194578-4

Cordless models

BHR262T DHR243 DHR264 HR262TD	194080-7
-------------------------------	----------

Drill chuck assembly (13mm)

(Chuck adapter assembly and Drill chuck)



*Inc.chuck key

Shank	Type	Part No.
SDS-PLUS	with key	122574-2
SDS-PLUS	with key	*194041-7
SDS-PLUS	keyless	122823-7
SDS-MAX	keyless	122829-5

Chuck adapter assembly (1/2"-UNC)

With screw M6 x 22



Part No.
D-14093

Drill chuck & Chuck key

(Use with chuck adapter)



Description	Part No.
Drill chuck (13mm)	192877-8
Chuck key	763432-9

SDS-MAX Drill bit remover set

(Use it with the impact wrench for removing SDS-MAX Drill bit stuck on rebar in concrete.)



Part No.
195870-1

Dust cover

(Protects tool holder from dust and debris during overhead operation)

For Model:
HK1800, HK1810

Part No.
423154-0



Miscellaneous

Dustcup set & Grip base set

*Standard equipment

Dustcup set

Use with Grip base set and Standard type side grip

Photo: 198362-9



Grip base set

with Spacer assembly, Hex. bolt and grip base

Photo: 194583-1



Model No.	Dustcup set	Grip base set
	Part No.	Part No.
HR1840, HR1841F, DHR165, HR166D	198362-9	194581-5
HR2230, HR2460/F		194583-1
HR2470/F, HR2475, BHR262, DHR263, HR262D, DHR202, DHR241		194582-3
HR2800, HR2810, HR2811F	194580-7	*
HR2300, HR2600, HR2601, HR2610, HR2611F, HR2630, HR2631F, HR2641, DHR242, DHR280, DHR282, HR2650, HR2651 HR2661	195173-3	*
HR2320T, HR2610T, HR2611FT, HR2630T, HR2631FT, DHR243, DHR281, DHR283, HR2651T	195179-1 195180-6	*

Dustcup set Component



Size	Dustcup set	Part No.	Component	Part No.
HR1840, HR1841F, DHR165, HR166D, HR2230, HR2460/F, HR2470/F, HR2475, BHR262, DHR263, HR262D, DHR202, DHR241, HR2432, HR2800, HR2810, HR2811F	198362-9		O-ring 20	213310-8
HR2300, HR2600, HR2601, HR2610, HR2611F, HR2630, HR2631F, HR2641, DHR242, DHR280, DHR282, HR2650, HR2651, HR2661			195173-3	
HR2320T, HR2610T, HR2611FT, HR2630T, HR2631FT, DHR243, DHR281, DHR283, HR2651T	195132-7 195179-1 195180-6		O-ring 20	213310-8

Grip base set

For Dustcup set



Model No.	Grip base set	Part No.	Component	Part No.
HR1840, HR1841F, DHR165, HR166D	194581-5		Hex.Bolt m8x110	921919-9
HR2230, HR2460/F			Grip base 20	419975-6
	194583-1		Hex.Bolt m8x110	921919-9
HR2470/F, HR2475, BHR262, DHR263, HR262D, DHR202, DHR241			Grip base 20	419975-6
	194582-3		Hex.Bolt m8x110	921919-9
HR2432			Grip base 20	419975-6
	-		Hex.Bolt m8x110	921919-9
			Grip base 20	419975-6

Hammer service kit

Model No.	Part No.
DHR242, DHR280D, DHR282	195833-7
BHR262/T DHR263, DHR264, HR262D, HR262TD	195189-8

Anti kick back head assembly

Model No.	Voltage	Part No.
BFH040/F, BFH090/F, BFH120F, BFT040F/R, BFT041F, BFT042F, BFT043F, BFT080F/R, BFT081F/R, BFT082F, BFT083F, BFT122F/R, BFT123F, BFT124F, BFT125F	NZ	195232-3

Protector



Model No.	Voltage	Part No.
6796FD, 6797FD, 6798FD, BFT120/F, BFT121F	Yellow	417616-8
	Blue	417615-0
	Red	417605-3
BFT020F, BFT021F, BFT040F, BFT041F/R, BFT043F, BFT080F, BFT081F, BFT082F/R, BFT083F, BFT122F, BFT123F, BFT124F/R, BFT125F	Clear	450331-1
	Yellow	418423-2
	Blue	418424-0
	Red	418425-8
BFL080F, BFL081F, BFL120F, BFL121F, BFL200F, BFL201F, DFL201R	Clear	418066-0
	Yellow	418032-7
	Blue	418064-4
DFH040F, DFH090F, DFH120FR	Red	418065-2
	Clear	450331-1
	Yellow	418423-2
	Blue	418424-0

Miscellaneous

Pipe

Model No.	Part No.
4100NB, 4100NH	164405-9
4101R, 4101RH	153409-6
4107R, 4107RH	164350-8



Vinyl tube



Model No.	Size (mm)	Part No.
4100NB, 4100NH, 4101RH, 4101R, 4140	5x7x5,000	412010-9
4107R, 4107RH	5x9x5,000	412028-0

Rip fence (Guide rule)

4101RH(Use with 924206-5 Wing bolt M5 x 10)
4131(Use with 265701-9 Wing bolt M6 x 14)
For Model: 4100NB, 4100NH, 4105KB, 4131, 5057KB, 4101RH, 4157KB



Part No.
164095-8

Guide rail adapter set

Use with Guide rail and Clamp set
For Model: 4100KB, 4100NH2



Part No.
198673-2

Base set

(To set cutting depth)

Model No.	Part No.
4110C	122263-9
4112H/S/HS	122683-7
4114, 4114S	165431-1



Portable band saw stand, Cover & Fluorescent light set

(For accurate square cutting operations)
For Model: 2107F



Description	Part No.
Portable band saw stand	194026-3
Cover	196325-9

For Model
DPB181

Cover	196585-3
-------	----------

Cutting wax

For Model: DPB181, DPB180, 2106, 2106W, 2107F, 2107FW

Part No.
191897-9



Shear blade

(Two per set in blister pack.)



Model No.	Part No.
JS1600, JS1602	191383-0
JS1601, DJS160, DJS161	792533-6
JS1000, DJS100, DJS101	792536-0
JS3200, JS3201	792287-5

Shear head assembly

Model No.	Part No.
JS1300	125112-9

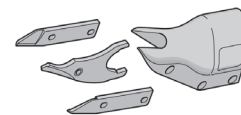

Cutter blade set for DSC102

Replacing the cutting dice



Type	Cutting capacities	Part No.	
inch screw	Mild steel • Stainless steel	W3/8	199080-2
mm screw	Mild steel • Stainless steel	M6	199086-0
	Mild steel • Stainless steel	M8	199084-4
	Mild steel	M10	199082-8

Miscellaneous

Side blade

For Model: JS1300, DJS130

Model No.	Part No.
R	792742-7
L	792743-5



Center blade



Model No.	Application	Part No.
DJS130, JS1300	18Ga	792744-3
JS1601, DJS160, DJS161	-	792534-4
JS1000, DJS100, DJS101	-	792537-8

Thickness gauge

(For setting shear blades at the proper gap)



Model No.	Part No.
JS3200, JS3201	762007-1
JS1660, JS1601, DJS160, DJS161	762013-6

Punch



Model No.	Part No.
JN1601, DJN161, DJN160	A-83951
JN3200, JN3201	792728-1

Die



Model No.	Part No.
JN1601, DJN161, DJN160	A-15051
JN3200, JN3201	792292-2

Washer

(To keep clearance of 3.5 to 4.0mm, use a washer or two under the die when installing a resharpened die.)

A.Die, B.Washer

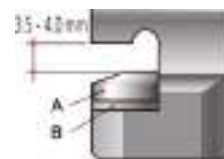

Model No.	Part No.
JN3200, JN3201	341796-7

Wrench



Model No.	Part No.
DJN160, DJN161, JN1601	781028-4
JN3200, JN3201	781019-5



Miscellaneous

Wheel guard

Bearing box type

A: Triple notches

B: Single notch

C: Twin notches

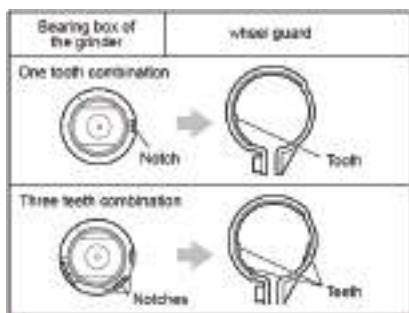

*Toolless type

*UP to 180mm size cup diamond wheel

Wheel size	Models	Bearing box type	market	for Depressed center wheel (Type:27, 28)/ Diamond wheel/ Strip disk	for Depressed center wheel with threaded arbor 5/8"-11 UNC (Type:27)	for Adrasive cut-off wheel (Type:1)	Dust collection wheel guard for diamond wheel		Dust collection wheel guard for cup diamond wheel
				Part No.	Part No.	Part No.	Type	Part No.	Type
100mm	GA4030 GA4030R GA4031 GA4032 GA4034 GA4040 GA4040C GA4041C, 553B 9553HB 9553HN 9553NB 9556HB 9556HN 9556HP 9556NB 9556PB	A	-	125885-4 *122893-6	-	122909-7	-	-	-
	9553B 9553HN 9553NB 9556HN 9556HP 9556NB 9556PB	B	-	125266-2	-	192626-3	A	192475-8	-
	GA4030 9556PB	A	USA CANADA GUAM MEXICO PANAMA	125885-4	-	122909-7	-	-	-
	9553HN 9556HN 9556NB	B	GUAM MEXICO PANAMA	125266-2	-	192626-3	A	192475-8	-
	.	B	Taiwan	-	-	-	A	192475-8	-
	9553HB 9553HN	B	Taiwan	-	-	-	A	192475-8	-
	9553B 9556NB 9556PB	B	Korea	-	-	-	A	192475-8	-
	9500N 9500NB	B	-	154755-0	-	-	A	192212-0	-
115mm	GA4530 GA4530R GA4534 GA4540 GA4540C GA4540R GA4541 GA4541C GA4541R 9554HN 9557HN 9557HNR 9557HP 9557NB 9557NBR 9557PB 9561CR 9564H 9564HR 9564P 9564PC 9564PCV	A	-	123098-1	-	122910-2	-	-	-
	9554HN 9557HN 9557HP 9557NB 9557PB 9564P	B	-	125267-0 *135107-4	-	122642-1	A B	- 192968-5 192972-4	-
	GA4530 GA4530R GA4534 GA4540 GA4540C GA4540R GA4541C GA4541R GA4542C GA4543C 9557HNR 9557HP 9564CV 9564P 9564PC 9564PCV	A	USA CANADA MEXICO PANAMA DOMINICA COLOMBIA	123098-1	123098-1 *123144-0	122910-2	-	-	-
	GA4530R GA4534 9557HNR 9557HP	A	DOMINICA	123098-1	*123144-0	122910-2	A B	- 192968-5 192972-4	-
	9557NB	A	USA CANADA	-	123098-1 *123144-0	122910-2	-	-	-
	9554HN 9557HN 9557HP 9557NB 9557PB 9564P	B	MEXICO PANAMA DOMINICA COLOMBIA	125267-0 *135107-4	125886-2	122910-2	A B	- 192968-5 192972-4	-
125mm	GA5010 GA5020 GA5020C GA5021 GA5021C GA5030 GA5030R GA5034 GA5040 GA5040C GA5040R GA5041 GA5041C GA5041R 9555HN 9558HN 9558HNR 9558HP 9558NB 9558NBR 9558PB 9562CH 9562CR 9562CVH 9562CVR 9565C 9565CLR 9565CR 9565CV 9565CVL 9565CVR 9565H 9565HR 9565P 9565PC 9565PCV	A	-	122887-1 123099-9	-	122911-0 *122905-5	-	-	-
	GA5020C GA5021C 9565C 9565CV 9565CVR 9565P	B	-	-	-	-	A B C	- 192968-5 192972-4 196846-1	195250-1 - -

Miscellaneous

Wheel size	Models	Bearing box type	market	for Depressed center wheel (Type:27, 28)/ Diamond wheel/ Strip disk	for Depressed center wheel with threaded arbor 5/8"-11 UNC (Type:27)	for Adrasive cut-off wheel (Type:1)	Dust collection wheel guard for diamond wheel		Dust collection wheel guard for cup diamond wheel
				Part No.	Part No.	Part No.	Type	Part No.	Type
	GA5010 GA5020 GA5020C GA5030 GA5030R GA5040 GA5042C GA5043C 9558HNR 9558NB 9558PB 9565CV 9565PC 9565PCV	A	USA CANADA GUAM MEXICO PANAMA DOMINICA COLOMBIA	-	-	122911-0 *122905-5	-	-	-
	GA5010 GA5034	A	GUAM COLOMBIA	122887-1	-	122911-0 *122905-5	-	-	-
	9005B 9005BZ	A	USA CANADA GUAM PANAMA	123099-9	123099-9	122911-0 *122905-5	-	-	-
	GA5021C	B	MEXICO PANAMA	-	-	-	A	192618-2	195250-1
							B	192968-5 192972-4	
C							196846-1		
GA5021C	B	Taiwan	-	-	-	A	192618-2	195250-1	
						B	192968-5 192972-4		
						C	196846-1		
150mm	GA6010 GA6020 GA6020C GA6021 GA6021C 9566PCV	B	-	*135110-5	-	-	-	-	-
	GA6010 GA6020 GA6021	C	-	135192-7	-	-	-	-	-
	GA6010 GA6011	B	MEXICO	135192-7 *135110-5	*135110-5	-	-	-	-
180mm	GA7010C GA7011C GA7012C GA7020 GA7020R GA7020S GA7021 GA7030 GA7030R GA7030S GA7031 GA7040 GA7040R GA7040S GA7050 GA7050R GA7060 GA7060R GA7061 GA7061R GA7062 GA7062R GA7063 GA7063R GA7064	A	-	122889-7 *122846-5	-	122914-4	-	-	-
	GA7010C GA7020 GA7020S GA7030 GA7030S GA7040S 9067	B	-	165215-7 *163446-2	-	-	B	194303-3	195387-4 195388-2
	GA7010C GA7020 GA7020S GA7021 GA7030 GA7030S GA7040R GA7040S	C	-	154674-0	-	-	B	194303-3	195387-4 195388-2
	GA7050 GA7050R GA7060 GA7060R,GA7061 GA7061R GA7062 GA7063R GA7064	A	USA CANADA GUAM MEXICO PANAMA COLOMBIA ECUADOR	122939-8	122939-8	122914-4	D	-	-
	GA7020	C	Taiwan	-	-	-	B	194303-3	195387-4 195388-2
	GA7010C	B	Korea	-	-	-	B	194303-3	195387-4 195388-2
	GA7010C GA7020 GA7020S GA7040S	C	Korea	-	-	-	B	194303-3	195387-4 195388-2
230mm	GA9010C GA9012C GA9020 GA9020R A9020S GA9030 GA9030R GA9030S GA9031 GA9040 GA9040R GA9040S GA9050 GA9050R GA9060 GA9060R GA9061 GA9061R GA9062 GA9062R GA9063 GA9063R	A	-	122891-0 *122847-3	-	122913-6	-	-	-
	9069 9069S	B	-	165216-5	-	-	B	194044-1	-
	9069 9069S 9617	B	-	165215-7	-	-	B	194044-1	-
	GA9010C	B	-	*163445-4	-	-	B	194044-1	-
	GA9020 GA9020R GA9020S GA9030 GA9030S GA9040R GA9040S	C	-	154672-4	-	-	B	194044-1	**195387-4
						D	198380-7	**195388-2	

Miscellaneous

Wheel size	Models	Bearing box type	market	for Depressed center wheel (Type:27, 28)/ Diamond wheel/ Strip disk	for Depressed center wheel with threaded arbor 5/8"-11 UNC (Type:27)	for Adrasive cut-off wheel (Type:1)	Dust collection wheel guard for diamond wheel		Dust collection wheel guard for cup diamond wheel
				Part No.	Part No.	Part No.	Type	Part No.	Type
230mm	GA9020 GA9031 GA9040S GA9050 GA9050R GA9060 GA9060R GA9061R GA9062 GA9063R	A	USA CANADA GUAM PANAMA ECUADOR COLOMBIA	-	-	122913-6	-	-	-
	GA9020	C	Taiwan	-	-	-	D	198380-7	**195387-4 **195388-2
	GA9020 GA9020S GA9040S	C	Korea	-	-	-	D	198380-7	**195387-4 **195388-2

Cordless Models

*Toolless type

*UP to 180mm size cup diamond wheel

100mm	DGA402 DGA404 DGA405 DGA406 DGA408 DGA411 DGA412 DGA413 DGA414 DGA417 DGA418	A	-	125885-4 *122893-6	-	122909-7	-	-	-
	DGA402	B	India, Indonesia, Malaysia, Philippines, Singapore, Thailand	-	-	192626-3	A	192475-8	-
	DGA402	B	Taiwan	-	-	-	A	192475-8	-
	DGA402	B	Korea	-	-	-	A	192475-8	-
115mm	DGA450 DGA452 DGA454 DGA455 DGA456 DGA458 DGA461 DGA462 DGA463 DGA464 DGA467 DGA468	A	-	123098-1	-	122910-2	-	-	-
	DGA454 DGA455 DGA456 DGA458	A	CANADA MEXICO PANAMA COLOMBIA	123098-1	123098-1	122910-2	-	-	-
	DGA452	A	DOMINICA	123098-1	123098-1	122910-2	-	-	-
	DGA452	B	MEXICO PANAMA COLOMBIA	125267-0	-	122642-1	A B C	192618-2 192968-5 192972-4 196846-1	-
125mm	DGA504 DGA505 DGA506 DGA508 DGA511 DGA512 DGA513 DGA514 DGA517 DGA518	A	-	-	-	122911-0 *122905-5	-	-	-
	DGA504 DGA505 DGA511 DGA512 DGA513 DGA514 DGA517 DGA518	A	CANADA MEXICO PANAMA	-	-	122911-0 *122905-5	-	-	-
180mm	DGA700	A	-	122889-7 *122846-5	-	122914-4	-	-	-
	DGA700	A	CANADA MEXICO PANAMA COLOMBIA	122939-8	122939-8	122914-4	-	-	-
	DGA700	A	Korea	-	-	-	-	-	195387-4
230mm	DGA900	A	-	122891-0 *122847-3	-	122913-6	-	-	-
	DGA900	A	CANADA MEXICO PANAMA COLOMBIA	-	-	122913-6	-	-	-

Miscellaneous

Lock nut and Rubber pad



Angle grinder

Wheel size	Markets	Spindle thread	Rubber pad			Sanding lock nut		Lock nut wrench	
			Pad Size (mm)	max. rpm	Parts No.	size (mm)	Parts No.	size	Part No.
100mm	-	M10 x 1.5	76	13700	743009-6	30	224502-4	20	782401-1 782420-7
9500N (100mm)	Guam, Hong Kong Indonesia, Vietnam, Philippines, Thailand, Kuwait, Saudi Arabia	M10 x 1.25	76	13700	743009-6	30	224501-6	20	782401-1
115mm	-	M14 x 2 (DIN)	100	12000	743036-3	48	224515-5	28/35	782412-6 / 782407-9 782423-1
	USA, Canada, Guam, Mexico, Dominica, Panama, Colombia Ecuador	5/8"-11 UNC	100	12000	743036-3	48	-	28	782412-6
125mm	-	M14 x 2 (DIN)	115	12000	743015-1	48	224515-5	28/35	782412-6 / 782407-9 782423-1
	USA, Canada, Guam, Mexico, Dominica, Panama, Colombia Ecuador	5/8"-11 UNC	115	12000	743015-1	48	-	28	782412-6
150mm	-	M14 x 2 (DIN)	125	10950	743016-9	48	224515-5	28/35	782412-6 / 782407-9 782423-1
	USA, Canada, Guam, Mexico, Dominica, Panama, Colombia Ecuador	5/8"-11 UNC	125	10950	743016-9	48	-	28	782412-6
180mm - 230mm	-	M14 x 2 (DIN)	170	8500	743012-7	48	224515-5	28/35	782412-6 / 782407-9
	USA, Canada, Guam, Mexico, Dominica, Panama, Colombia Ecuador	5/8"-11 UNC	170	8500	743012-7	48	-	28	782412-6
	Korea	M16	170	8500	743012-7	48	224523-6	28/35	782412-6 / 782407-9

Miscellaneous

Lock nut, Rubber pad and Hook & loop Pad for Sanding or Polishing



Models		Markets	Spindle thread	Rubber pad						Hook & loop Pad					
Wheel size	Pad Size (mm)			max. rpm	Parts No.	Sanding lock nut		Lock nut wrench		Pad type	Pad Size (mm)	max. rpm	Parts No.		
						size (mm)	Parts No.	size	Part No.						
Angle sander with water supply device	PK5011C	—	M14 x 2 (DIN)	115	12000	743015-1	48	224515-5	28 / 35	782412-6 / 782407-9	-	-	-	-	
		Canada Mexico, Panama, Colombia	5/8"-11 UNC	115	12000	743015-1	48	224517-1	28	782412-6	-	-	-	-	
	PK5001C	—	M14 x 2 (DIN)	115	12000	743015-1	48	224515-5	28 / 35	782412-6 / 782407-9	-	-	-	-	
Angle sander / Disc sander / Sander-polisher / Polisher	SA4540C	Mexico, Panama, Colombia	5/8"-11 UNC	100	12000	743036-3	48	224517-1	28	782412-6 / 782424-9	Hook & loop	105	8000	743062-2	
	SA5040C	—	M14 x 2 (DIN)	115	12000	743015-1	48	224515-5	28 / 35	782412-6 / 782424-9 / 782407-9 / 782423-1	Hook & loop	115	8000	743061-4	
	SA7000/ C GV7000 GV7000C 92185B 92075PB 9218PB 9218PBL	—	—	M14 x 2 (DIN)	170	8500	743012-7	48	224515-5	28 / 35	782412-6 / 782407-9	-	-	-	-
		USA, Guam, Mexico, Panama, Colombia	5/8"-11 UNC	170	8500	743012-7	48	224517-1	28	782412-6	-	-	-	-	
	9227C 9227CB 9237C 9237CB PV7001C PV7000C	—	—	M14 x 2 (DIN)	170	8500	743012-7	48	224515-5	28 / 35	782412-6 / 782407-9	Hook & loop	165	4000	743053-3
		USA, Guam, Mexico Panama Colombia	5/8"-11 UNC	170	8500	743012-7	48	224517-1	28	782412-6	Hook & loop	165	4000	-	
		Indonesia, Philippines, Thailand, Vietnam, China, Hong Kong, Korea, Taiwan	M16	170	8500	743012-7	48	224523-6	28 / 35	782412-6 / 782407-9	Hook & loop	165	4000	7430541	
		—	—	M14 x 2 (DIN)	-	-	-	-	-	-	-	Hook & loop	96	6000	743080-0

Plastic pad / Sponge pad for Disc sander GV6010 and GV5010

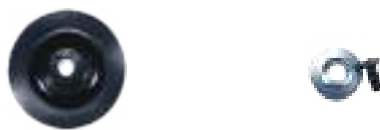

Models		Plastic pad							Sponge pad for PSA (Pressure Sensitive Adhesive)		
		Pad			Clamp screw		Countersunk washer		Pad Size (mm)	screw thread	Parts No.
		Pad Size (mm)	max. rpm	Parts No.	Size	Parts No.	Size (mm)	Parts No.			
Disc sander	GV5010	120	5000	743025-8	M8x20	265812-0	35	253951-8	-	-	-
	GV6010	120	5000	743025-8	M8x20	265812-0	35	253951-8	147	M8	743033-9

Miscellaneous

Lock nut wrench, Lock nut release socket

Lock nut wrench



Lock nut release socket
(Square drive :12.7mm)



Type	For Model	Size	Part No.
Lock nut wrench	All 100mm	20	782401-1
	All 100mm	20	782420-7
	115 / 125mm	35	782423-1
	115 / 125mm Models for North America	28	782424-9
	DIN & Old type	28	782412-6
Lock nut release socket	180 / 230mm	35	782407-9
	180 / 230mm	35	194305-9

Wheel guard

Single notch



for wire bevel brush

For Models	Part No.
100mm Angle grinder	192412-2

for wire cup brush

For Models	Part No.
100mm Angle grinder	192454-6
115mm Angle grinder	193066-8

Dust cover set, Dust collect brush



Model No.	Description	Part No.
PW5000C, PK5001C	Dust cover set	194233-8
	Dust collect brush	443121-9

Lock nut for Concrete planer

Models	Markets	Spindle thread	Arbor size (mm)	Lock nut wrench	
				Size	Part No.
PC5000C PC5001C	-	M14 x 2 (DIN)	22.23	35	782407-9
	USA CANADA GUAM MEXICO PANAMA	5/8"-11 UNC	22.23	28	782412-6
PC1100	-	M12 x 1.5	-15	20	782401-1

Dust cover attachment set



Model No.		Part No.
9562/CH/CVH, 9564/HR, 9565/C/CR/CV/CVL/CVR/HR, 9566CV GD0800, GD0800C, GD0810C	3 pcs. set	193903-6
GA5010, GA5020/C, GA6010, GA6020/C	2 pcs. set	194482-7
GA5021C, GA6011, GA6021/C, GA7010C, GA7012C, GA9010C, GA9012C, PC5000C, PC5001C, SA7000, SA7000C	2 pcs. set	193956-5
GA7020/R/S, GA7021, GA7030/R/S, GA7031, GA7040R/S, GA9020/R/S, GA9030/R/S, GA9031, GA9040R/S	2 pcs. set	194289-1
GA7050/R, GA9050/R, GS5000, GS6000	2 pcs. set	195059-1

Sleeve 18

(For centering pads)
For Model: 9237C/CB, 9227C/B, PV7001/C, PV7000C, SA7000C

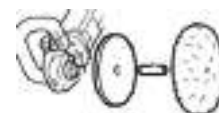

Part No.
262542-4

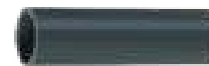

Miscellaneous

Head cover



Model No.	Part No.
9564CVL, 9565CVL, 9565CLR, PW5000C, PW5001C, PK5001C	417322-5
9227C/CB	417671-0
SA7000/C, PK5011C	418529-6

Collet cone , Collet nut and Wrench size



Model No.	Size	Collet cone	Collet nut	Wrench Size
		Part No.	Part No.	
906,906H	3mm	763627-4	-	10mm 17mm
	6mm	763620-8		
	1/8"	763626-6		
	1/4"	763625-8		
GD0600, GD0601	3mm	763627-4	763664-8	13mm x2
	6mm	763620-8		
	1/8"	763626-6		
	1/4"	763625-8		
GD0603	3mm	763627-4	763236-9	10mm x2
	6mm	763620-8		
	1/8"	763626-6		
	1/4"	763625-8		
GD0602	3mm	763669-8	763668-0	13mm x2
	6mm	763670-3		
	8mm	763671-1		
GD0800, GD0800C, GD0810C, GD0801C, GD0811C	1/4"	763650-9	763645-2	13mm 19mm
DGD800 DGD801	3mm	763669-8	763668-0	13mm 19mm
	6mm	763670-3		
	8mm	763671-1		

Collet cone & nut set

Bit diameter (mm)	Overall length (mm)	Working length (mm)	Part No.
GD0800, GD0800C, GD0810C, GD0801C, GD0811C	3mm	193011-3	13mm 19mm
	6mm	193012-1	
	8mm	192988-9	
	1/4"	193143-6	

Side handle set



Model No.	Part No.
GD0600, GD0601, GD0602, GD0800/C, GD0801C, GD0810C, GD0811C, DGD800, DGD801	192985-5

Vise holder set



Model No.	Part No.
GD0800/C, GD0801C, GD0810C, GD0811C	193141-0

Carbon plate

Model No.	Part No.
9401, 9402	423029-3
9403	421648-9
9404	193201-8
9900B	423027-7
9902, 9903	193197-3
9920	193198-1



Cork rubber plate

(For use with Carbon plate or Steel plate.)

Model No.	Part No.
9401, 9402, 9403	421093-8
9404	193202-6
9902, 9903	193199-9
9920	193200-0



Steel plate

A: Include cork rubber plate

Model No.	Type	Part No.
9401, 9402	-	342328-3
9403	A	150980-1
9404	A	151751-9
9901	-	343355-3
9924DB	-	341705-6
9902, 9903	A	151749-6
9920	A	151750-1



Miscellaneous

Step



Model No.	Part No.
9401, 9402	342332-2

Stand set



Model No.	Part No.
9032	193618-5

Belt sander stand



Model No.	Part No.
9404, 9902, 9903, 9920	193055-3
9924DB	STEX122299

Sanding shoe assembly



Model No.	Part No.
9404	193072-3
9902, 9903	193070-7

Clamp complete



Model No.	Part No.
9910, 9911	192694-6

Punch plate

(For allowing dust extraction through the base)



Model No.	Material	Part No.
BO3700, BO3710	METAL	192989-7
BO3710, BO3711	PLASTIC	194947-9
BO4900/V, BO4901, 9046	-	192523-3
BO4555, BO4556, BO4557, BO4558	-	450066-4

Pad complete

*hook & loop type
For use with Abrasive paper

Model No.	Part No.
BO3710, BO3711	194929-1
	*194930-6



Ring

(For 5/8" = 15.88 mm spindle)



*With milled edge.

Outer Dia (mm)	Hole Dia (mm)	Thickness (mm)	Per pkg.	Part No.
25	15.88	4	1	257022-3
25.4	15.88	4	1	257060-5

Holder set

A: Holder 2pc, Thumb screw 2pc
B: Holder 2pc, Thumb screw 3pc, Set plate 1pc



Model No.	Type	Part No.
LS1016/F/FL/L, LS1216/F/FL/L	A	195240-4
LS0714/F/FL/L, LS1030N, LS1040/F, LS1212, LH1040/F, BLS713	A	192621-3
LS1440	B	191239-7

Crown molding stopper set



Model No.	Part No.
DLS110, DLS111, DLS112, LS1019/L, 1219/L	192628-9
LS1045, LS1040/F, LH1040/F, LS1030N	192622-1
LS1220, LS1221, LS1016/F/FL/L	192669-5

Miscellaneous

Vertical vise assembly & Horizontal vise assembly

Vertical vise assembly



Horizontal vise assembly



Description	Model No.	Part No.
Vertical vise assembly	DLS714, LS0714/F/FL/L	122571-8
	LS1013/F/L/FL	122538-6
	LS1045, LH1040/F	192625-5
	LS1040/F, LS1030	122536-0
	LS1016/F/FL/L, LS1216/F/FL/L	122854-6
Horizontal vise assembly	DLS714, LS0714/F/FL/L, BLS713	122567-9
	LS1220, LS1221, LS1016/F/FL/L, LS1214/F/L/FL, LS1013/F/L/FL, LS1019/L, DLS110, DLS111, DLS112	122470-4
	LS1216/F/FL/L, LS1017L, LS1018L	122930-6
	LS1045, LS1040/F, LH1040/F, LS1030N, LS1440	122563-7

Set plate

(For uniform cutting width)



Model No.	Part No.
LS0714/F/FL/L, LS1212, LS1030N, LS1040/F, LS1045, LH1040/F	122472-0

Sub fence complete



Model No.	Part No.
LS1013/F/L/FL, LS1214/F/L/FL	194002-7

Holder assembly

Use 2 Rod 12 (256812-1) and Holder assembly for supporting long stock. See below.
A : Rod 12 (Length 2.1 m), B: Holder assembly



Model No.	Part No.
LS1030N, LS1040/F, LS1045, LH1040/F	122446-1

Guide rule



(Rip fence)

Model No.	Part No.
5005BA, 5007F/FA/NB/NH/NL/MG/MGA, 5057KB, 5600NB, 5606B, 5604R, 5008B/F/FA/NBA/MG/MGA, 5704R, 5740NB, 5800NB, 5806B/NH, HS7100, HS7000, HS7601, HS7601, HS7101, HS6100, HS6101	164095-8
5900B, 5901B, 5902B	164021-7
N5900B, 5901B, 5902B, HS0600	164367-1
5103N, 5201N/NA, 5401N, 5402/NA	164019-4
SP6000	165447-6

Rip fence assembly



Model No.	Part No.
2702, 2703	122556-4

Angle rule assembly (Miter gauge)

*Sliding guide



Model No.	Part No.
2702, 2703	122555-6

Stand: A



Model No.	Part No.
MLT100, 2702, 2703	JM27000300

Stand: B



Model No.	Part No.
All Slide Compound saw, Miter saw	194043-3

Miscellaneous

Stand: C

194943-7



WST06



Model No.	Part No.
All Slide Compound saw, Miter saw	194943-7
All Slide Compound saw, Miter saw and Table Top Miter Saw	WST06

Sub table & Stand set

A: Sub table L, B: Stand set, C: Sub table R



Model No.	Material	Part No.
2702, 2703	Stand set	193920-6

Guide rail



Overall Length (mm)	Part No.
1.0	199140-0
1.4	194368-5
1.9	194925-9
1.5	199141-8
3	194367-7



Guide rail Connector

Part No.
P-45777



Guide rail bag

For 1.4m, 1.5m Guide rail



Part No.
B-57613



Clamp set

(Use with Guide rail)

Part No.
194385-5



Ratchet clamp complete

Part No.
199826-6



Bevel guide set

Adjustable angle of Guide Rail

Part No.
196664-7



Guide rail adapter

(Use with Guide rail)
*Rule bar

Part No.
196664-7



Model No.	Part No.
4350T/CT/FCT, 4351T/CT/FCT, DJV140, DJV180	193517-1
HS7100, HS7101, HS6100, HS6101, 4350T/CT/FCT, 4351T/CT/FCT, DJV140, DJV180, DJV141, DJV142, DJV181, DJV182	197252-3
DHS680	196953-0

Miscellaneous

Guide rule

(Rip fence)

A:Guide rule & circular guide set, B:Circular guide assembly

Guide rule

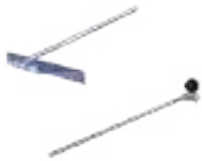

Circular guide assembly



Model No.	Type	Part No.
4300BA, 4300BV	-	164113-2
4326/M, 4327/M, 4328, 4329, JV0600, JV100D, JV102D, JV103D, JV143D, JV183D	A	192732-4
4350T/CT/FCT, 4351T/CT/FCT, DJV140, DJV180, DJV141, DJV181, DJV142, DJV182,	A	193516-3
4300BA, 4300BV, 4301SB	B	123030-5

Blade clamp assembly

(For use of 6.35mm universal shank blades)



Model No.	Part No.
4300BA, 4300BV	132276-260

Dust nozzle

(Vacuum head)

Please see Suction system chart.



Model No.	Part No.
4350T/CT/FCT, 4351T/CT/FCT, DJV140, DJV180	417853-4
DJV141, DJV181, DJV142, DJV182	126331-0

Protector

(Transparent cover in front of blade)



Model No.	Part No.
4331D, 4333D, 4334D	415887-1

Anti-splintering device

(For cleaner cuts)



Model No.	Part No.
DJV140, DJV180, DJV141, DJV181, DJV142, DJV182, 4331D, 4333D, 4334D, 4328, 4329, 4350T/CT/FCT, 4351T/CT/FCT, JV0600, JV100D, JV413D, JV183D	192557-6
4326, 4327, 4328	192733-2

Cover plate



Model No.	Part No.
4331D, 4333D, 4334D	413068-1
4326, 4327, 4329, 4350T/CT/FCT, 4351T/CT/FCT, DJV140, DJV180, DJV141, DJV181, DJV142, DJV182, JV0600, JV100D, JV143D, JV183D	417852-6

Belt sanding attachment set

Use a sanding belt that is 2240 mm long and 20 mm wide or less.



Model No.	Part No.
LB1200F	JM21000330

Set plate



*2 per pkg.

Model No.	Part No.
1100/N, N1900B, 1902, N1923B, 1923H, KP0810/C, KP0800, DKP180, DKP140	*193540-6
	A-86175

Sharpening holder assembly



Model No.	Part No.
1100/N, N1900B, 1902, N1923B, 1923H, KP0810/C, KP0800, DKP180, DKP140	123004-6
1600	123007-0
1804N, 1805N, 1806B	123006-2
1002BA, 1911B	123055-9

Miscellaneous

Dressing stone

For HSS planer blade



Size (mm)	Grit	Part No.
150	WA1200	794061-7
150	GC1200	D-17756
180	WA1200	794060-9

Blade gauge assembly



Model No.	Part No.
1804N,1805N	123009-6
1100/N, 1911B, N1900B, KP0810/C, N1923B, 1923H, 1902, 1002BA, KP0800, DKP180, DKP140	123062-2
2012NB	762016-0

Extension guide set



Model No.	Part No.
1911B, N1900B, N1923B, KP0800, DKP180, DKP140	191725-8

Edge fence

(Guide rule)

* Destination : Europe

**with screw



Model No.	Part No.
1100	161046-2
1100N	**193617-7
1804N,1805N	**191454-3
N1900B, N1923B, 1911B	**191455-1
N1900B, N1923B, KP0800, DKP180, DKP140	*195055-9
KP0810/C	122785-9
1600	123032-1
N1900B, N1923B, KP0800, DKP180, DKP140	123060-6



Chamfering rule assembly



Model No.	Part No.
KP0810/C	122791-4

Depth guide



Model No.	Part No.
KP0810/C, N1923B, 1923H	342390-8

Nozzle assembly

(Non-clogging chip deflection in desired direction)

*Elbow (use with Nozzle)

**Nozzle



Model No.	Part No.
1804N	STEX122198
N1900B,N1923B	JPA122194
KP0810/C, KP0800, DKP180, DKP140	*416368-8
KP0800, DKP180, DKP140	**451329-1

Hood set

Outer dia. 76 mm



Model No.	Part No.
2012NB	193036-7

Triangular rule



Model No.	Part No.
1600,1806B,1923H, KP312/S	762001-3

Miscellaneous

Magnetic holder



Model No.	Part No.
2012NB	762014-4

Socket wrench 9



Model No.	Part No.
1002BA, 1100/N, 1600, N1900B, 1902, 1911B, KP0800, KP0810/C, KP312, N1923B/H, 1804N, 1805N, 1806B, DKP180, DKP140	782209-3
2012NB	782203-5

Guide rule

For Model: 3501N



Type	Part No.
A	164443-1
B	161025-0

Flange

*For cutter blade with 2.4mm - 7.5mm thickness.
For Model: 3501N



Type	Part No.
Flange 35	*224051-1
Outer flange 56	224003-2
Inner flange 56	224106-2

Shiplapping scale assembly



Model No.	Part No.
3501N	133473-3

Dressing stone



Model No.	Part No.
3501N	794063-3

Wrench



Model No.	Size (mm)	Part No.
3501N	19	781206-6
	21	781029-2

Angle guide



Model No.	Part No.
3901, PJ7000, DPJ180, DPJ140	415579-2

Set plate

To center joiner blade on 12mm stock while using pivoting fence



Model No.	Part No.
3901, PJ7000, DPJ180, DPJ140	415579-2

Biscuit (100 pcs. in set)

• Premium quality, Select cut size, High strength, Finely ground edges
Compressed beachwood



Size	Type	Per pkg.	Part No.
3901, PJ7000, DPJ180, DPJ140	#0	47 x 15	A-16922
	#10	53 x 19.5	A-16938
	#20	60 x 23.5	A-16944

Lock nut wrench



Model No.	Part No.
3901, PJ7000, DPJ180, DPJ140	782401-1

Oil supply 100 mL



Model No.	Part No.
7104L	182229-1

Miscellaneous

Straight guide assembly

(Straight guide)

A: Straight guide with micro adjustment



* Use with Plunge base assembly

Model No.	Type	Material	Part No.
3709, 3710	-	-	122704-5
3600H, 3601B	-	-	123029-0
3705	-	-	341947-2
3612BR, RP1800/F, RP1801/F, RP2300FC, RP2301FC	-	-	342428-9
RP0900, RP0910, RP1110C, *RT0700C	-	-	164834-6
3612BR, RP0900, RP0910, RP1110C, RF1100, RF1101, RD1100, RD110, RP1100, RP1101, RP1800/F, RP1801/F, RP2300FC, RP2301FC, *RT0700C	A	Steel	193312-9
RP1800/F, RP181/F, RP2300FC, RP2301FC, RP0900, RP0910, RP1110C, *RT0700C, *DRT50	A	Alumi w/o mark of origin	195136-9

Guide holder assembly



Model No.	Part No.
3612BR	122256-6
RP1800/F, RP1801/F, RP2300FC, RP2301FC	122700-3

Trimmer guide assembly

* Use with Plunge base assembly



Model No.	Part No.
3707/F/FC, 3708/F/FC, 3709, 3710, N3701, RT0700C	122703-7
3600H, 3601B	122343-1
3612BR, RP1800/F, RP1801/F, RP2300FC, RP2301FC	123022-4
RP0900, *RT0700C, *DRT50	STEX122385

Sash router base assembly

Model No.	Part No.
N3701, 4402, 4403	JPA122201



Guide rail adapter set



1. Guide rail adapter set



2. Guide rail



3. Clamp set



3. Ratchet clamp complete



* Use with Plunge base assembly

Type	For Model	Part No.
1	3612BR, RP0900, RP0910, RP1110C, RP1800/F, RP1801/F, RP2300FC, RP2301FC, *RT0700C	194579-2
2	Guide rail 1.0m	199140-0
	Guide rail 1.4m	194368-5
	Guide rail 1.5m	199141-8
	Guide rail 1.9m	194925-9
	Guide rail 3.0m	194367-7
3	Clamp set	194385-5
4	Ratchet clamp complete	199826-6

Trimmer base assembly

A: Transparent base

B: For chamfering

C: Fine depth adjustment



Type	For Model	Part No.
-	3700B, N3701, 3703, 3704, 4403	122202-9
A		122238-8
B		STEX122390
A,C	3709, 3710	194267-1
A		194268-9
B,C		194269-7
B		194270-2

Miscellaneous

Collet cone / Collet nut

Trimmer



Model No.	Wrench size	Collet cone		Collet nut
		Size	Part No.	Part No.
3700B 3701, 3703, 3707/F/FC, 3708/F/FC,	10mm 17mm	6mm	763607-0	763606-2
		1/4"	763608-8	
3703, 3709, 3710, 4403	10mm/17mm	1/4"	763663-0	763661-4
RT0700C	13mm 22mm	6mm	763636-3	763615-1
		8mm	763618-5	
		1/4"	763637-1	
		3/8"	763619-3	

Router



*with header & poly bag

Model No.	Wrench size	Collet cone		Collet nut
		Size	Part No.	Part No.
3600H, 3612 3612BR, 3612C	13mm 24mm	12mm	763628-2	763629-0
		1/2"	763622-4	
RP0900	13mm 22mm	6mm	763636-3	763615-1
		8mm	763618-5	
		1/4"	763637-1	
		3/8"	763619-3	
RP1800, P1800F, RP1801, P1801F, RP230FC, RP231FC	24mm	12mm	763628-2	-
		1/2"	763622-4	

Sash router



Model No.	Wrench size	Collet cone		Collet nut
		Size	Part No.	Part No.
4403	10mm/17mm	1/4"	763663-0	763661-4

Cut-out tool



Model No.	Wrench size	Collet cone		Collet nut
		Size	Part No.	Part No.
3706	17mm	6mm	763607-0	763606-2
		1/4"	763608-8	

DC Trimmer



Model No.	Wrench size	Collet cone		Collet nut
		Size	Part No.	Part No.
DRT50	13mm/ 22mm	6mm	763636-3	763615-1
		8mm	763618-5	
		1/4"	763637-1	
		3/8"	763619-3	

DC Cut-out tool



*With HEADER & POLY BAG

Model No.	Wrench size	Collet cone		Collet nut
		Size	Part No.	Part No.
DCO180	17mm	1/8"	763677-9	763675-3

Collet sleeve



Model No.	Collet size	Bit size	Part No.
RP1800, RP1800F, RP180, RP1801F, RP230FC, RP231FC, 3600H, 3601B, 3612, 3612BR, 3612C	1/2"	1/4"	763803-0
	1/2"	3/8"	763805-6
	1/2"	10mm	763806-4
	12mm	6mm	763801-4
	12mm	8mm	763804-8
	12mm	10mm	763807-2
	12mm	1/4"	763808-0

Templet guide

(For fast production of complicated shapes by using templet.)

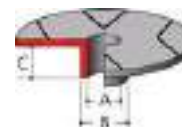

A: For North America

Model No.	A (mm)	B (mm)	C (mm)	Type	Part No.
3707/F/FC, 3708/F/FC, 3709, 3710, N3701, RT0700C, DRT50	8	10	9.5	-	343577-5



RT0700C, DRT50 : Use with Plunge base assembly

3612BR, RP0900, RP1800/F, RP1801/F, RP2300FC, RP2301FC, RT0700C, DRT50	7.7	9.5	11.5	-	164379-4
	9	11	13	-	164775-6
	10	12	9	-	164388-3
	11	12.7	13	-	164776-4
	14	17	20	-	165366-6
	14.5	16	13	-	344364-5
	18	20	13	-	164393-0
	22	24	13	-	165364-0
	24	27	13	-	164470-8
	25	29	15	-	163080-8
	27	30	13	-	164471-6
	37	40	13	-	165046-4
37	40	13	-	164472-4	



3600H, 3601B	7.7	9.5	8	-	323448-2
	9	11	5	-	323023-4
	11.1	12.7	14.3	-	321472-9
	10.9	12.7	8	-	323449-0
	14	16	8	-	323018-7
	14	16	14.5	-	321308-2

Miscellaneous

Templet guide adapter 30

(For B & D, Porter-Cable two-piece templet guide)

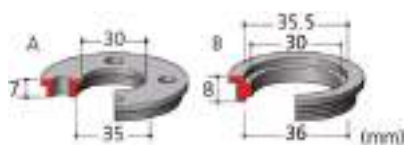

Nut M30
Part No. 252627-4

Templet guide adapter 30
Type A or Type B

Templet guide 25
Part No. 321812-1



RT0700C, DRT50: Use with Plunge base assembly

Model No.	Voltage	Part No.
3612BR, RP0900, RP1800/F, RP1801/F, RP2300FC, RP2301FC, RT0700C, DRT50	A	321492-3
3600H, 3601B	B	321493-1

Knob 55 complete



Model No.	Part No.
3612BR, RP1800/F, RP1801/F, RP2300FC, RP2301FC	158980-5

Trimmer shoe

(Enables accurate chamfering and other edge works)



Model No.	Part No.
3707/F/FC, 3708/F/FC, N3701, 4403	155263-4

Base assembly

Able to meet a wide range of needs with the Motor unit and the following various attachments

This versatile system enables user to easily customize Model RT0700C.
For Model:
RT0700C, DRT50

Plunge base assembly

Optional Fine adjusting straight guide can be used.



Per pkg.	Part No.
1	195563-0

Tilt base assembly

Tilting capacity: -30° to 45°



Per pkg.	Part No.
1	195561-4

Offset base assembly

Able to trim close to wall and tight corners with a bit set in offset position.
Distance 18.5mm from the edge to the center of bit



Part No. (EU)
195562-2

Grip attachment

Use with countersunk head screw M4x10



Part No.
318685-1

Miscellaneous

Base plate

(base protector)

For Model: RT0700C, DRT50

Trimmer base plate

Part No.
413149-1



Plunge base plate

Part No.
450819-1



Joint

(For Festo type Hose)



Model No.	Part No.
BO4900/V, BO4901, BO6040	417408-5

Dust box assembly

*use with Paper dust bag 194746-9

**use with Filter set 195133-5



Model No.	Part No.
DBO140, DBO180, BO4555, BO4556, BO4557, BO4558, BO4565, BO4566, BO5030, BO5031, BO5040, BO5041	*135246-0
DBO140, DBO180, BO4555, BO4556, BO4557, BO4558, BO4565, BO4566, BO5030, BO3710, BO3711, BO5031, BO5040, BO5041	**135246-0

Paper dust bag holder



Model No.	Part No.
BO4900/V, BO5020, BO5021, BO6030, 9046	193294-5
BO4553, BO4554, BO4561, BO4563, BO5010, BO5021	193932-9

Paper dust bag and Filter set

(5pcs./set)

*w/o mark of origin



Model No.	Part No.
Paper dust bag	
BO4900/V, BO5020, BO5021, BO6030, 9046	193293-7
DBO140, DBO180, BO4555, BO4556, BO4565, BO4566, BO4557, BO4558, BO5030, BO5031, BO5040, BO5041	194746-9
Filter set	
DBO140, DBO180, BO4555, BO4556, BO4565, BO4566, BO4557, BO4558, BO3710, BO3711, BO5030, BO5031, BO5040, BO5041	*195133-5

Dust Bag



Model No.	Part No.
UB1100, UB1101	122321-1
DUB142, DUB182	122814-8
DVC340, DVC350	122918-6
4100KB	126738-0
9401, 9402	122297-2
9924DB	122296-4
9901	122329-5
9902, 9903, 9404, 9920	122591-2
9921, 9403, SP6000	122562-9
9910, 9911	122548-3
PC5000C, PC5001C	122853-8
9046	152456-4
BO3710, BO3711	140115-2
DLS110, DLS111, DLS112, LS1216/F/FL/L, LS1019/L, LH1040/F	122852-0
LS1017L, LS1018L	JM23100501
1100/N	STEX122312
1911B	122402-1
1902, N1900B, N1923B	122230-4
KP0810/C, KP0800, DKP180, DKP140	122793-0
3901	122474-6
PJ7000, DPJ180, DPJ140	123150-5
PC1100	122193-4
MT 940	135132-5

ACCESSORIES

▣ Blue Collection



Blue Collection

P-80977 - Tool Bag

- Rigid gate-mouth opening
- Spacious main compartment
- Adjustable shoulder strap with pad

	metric
height:	300 mm
length:	500 mm
width:	300 mm
weight:	1,93 kg



P-80949 - Tool Case Wing Tote

- Case's covers with two-sided wide 'wing' opening
- Covers protect tools from dirt and water
- A large number of internal pockets provides great organization

	metric
height:	400 mm
length:	510 mm
width:	290 mm
weight:	2,44 kg



P-80896 - Smart Phone Holder

- Universal size fits most most smart phones
- Soft internal lining to protect you phones screen
- Fits any MAKITA Tool Belt

	metric
height:	150 mm
length:	100 mm
width:	25 mm
weight:	0.09 kg



P-80999 - Pencil Driver Holster

- Designed to hold cordless power tool models
- Hook-and-loop security strap ensures safe climbing ladders and scaffolding

	metric
height:	320 mm
length:	80 mm
width:	50 mm
weight:	0.12 kg



P-67810 - Protective Guide Rail Holder

- Padded holder fits perfectly 2 guide rails & 2 clamps
- High quality hook and loop straps keep the rails secure

	metric
height:	230 mm
length:	1500 mm
width:	35 mm
weight:	1.23 kg



P-71722 - Drill Holster and Pouch

- Unique design complete interchangeability between left and right users
- Fits cordless or main-powered drill

	metric
height:	280 mm
length:	255 mm
width:	160 mm
weight:	0.58 kg



P-71738 - Electricians' Pouch

- The pouch sits comfortably on Makita tool belt
- Able to carry a full range of specialized electrician tools

	metric
height:	315 mm
length:	250 mm
width:	140 mm
weight:	0.50 kg



P-71744 - General Purpose Pouch

- Open design provides quick tool recognition
- Universal tool loop holds bigger tools
- Rubber handle provides simple adjustments

	metric
height:	320 mm
length:	350 mm
width:	170 mm
weight:	0.72 kg



P-71750 - 2 Pocket Fixings Pouch

- Strong construction with riveted reinforcement
- The pouch sits comfortably on Makita tool belt

	metric
height:	265 mm
length:	260 mm
width:	135 mm
weight:	0.53 kg



P-71794 - Drill Holster Universal L/R Handed

- Designed to hold mains powered or cordless drills.
- Elasticated drill bit loops provide convenient storage

	metric
height:	290 mm
length:	170 mm
width:	85 mm
weight:	0.26 kg



Blue Collection

P-71803 - "Heavyweight" Leather Belt

- Hard wearing premium leather belt
- Featuring a twin pin buckle for extra strength and security.

	metric
height:	48 mm
length:	1380 mm
width:	-
weight:	0.29 kg



P-72017 - Tool Rucksack with Organizer

- Backpack, great alternative to the classic tool bag
- Rubber carry handle provides simple adjustments

	metric
height:	410 mm
length:	295 mm
width:	240 mm
weight:	1.73 kg



P-71819 - "Super-Heavyweight" Belt

- The ultimate tool retention system is made from a combination of tough nylon, soft mesh material and riveted reinforcement.

	metric
height:	140 mm
length:	865 mm
width:	-
weight:	0.62 kg



P-71825 - Quick Release Belt

- Polyethylene strap inside to keep a vertical shape of the belt without danger of twist after some time of use
- Nice looking belt loop with HI-VIS trimming

	metric
height:	50 mm
length:	1340 mm
width:	-
weight:	0.23 kg



P-71881 - Electricians' Mate

- Multi-purpose versatile tool holder - includes 5 pockets
- Can be worn either on a belt or clip onto pockets.

	metric
height:	160 mm
length:	155 mm
width:	50 mm
weight:	0.26 kg



P-71897 - "Super-Heavyweight" Champion Belt

- The ultimate tool belt system is made from a combination of tough nylon and high grade
- Fully padded by 3D mesh breathable material for extra comfort

	metric
height:	340 mm
length:	865 mm
width:	-
weight:	1.58 kg



P-71978 - Gel Knee Pads Heavy Duty

- One size fits all
- Heavy Duty Makita knee pads are designed to put maximum protection where it is needed most.

	metric
height:	315 mm
length:	250 mm
width:	140 mm
weight:	0.50 kg



P-71984 - Knee Pads Light Duty

- One size fits all
- Maximum comfort when kneeling.
- Flexible lightweight knee pad

	metric
height:	210 mm
length:	175 mm
width:	50 mm
weight:	0.18 kg



P-72001 - Tool Case Open Tote

- Reinforced sides to give maximum tool protection
- Open design for quick tool location
- Heavy-duty steel handle

	metric
height:	335 mm
length:	450 mm
width:	285 mm
weight:	2.30 kg



P-72095 - Bucket Tote

- HI-VIS trimming makes the tote eye-catching
- Open design for quick tool location
- Made of soft polyester 600D material

	metric
height:	320 mm
length:	470 mm
width:	-
weight:	0.38 kg



Combination / Rotary Hammer Drill Capability Chart

Series	Model	EPTA Weight (kg)	EPTA Weight (kg)																Material for drilling				Drilling/ chiselling ratio							
			0	10	20	30	40	50	60	70	80	90	100	110	120	130	140	150	160	Highly reinforced concrete	Concrete, granite, stone, brick	Metal/ wood		Working direction						
16mm series	DHR165	2.2	Yellow			Red		Blue		Diamond core 32 (dry type)																✓	✓✓✓	✓	↔	Green
	SDS-plus		Yellow			Red		Blue		Diamond core 32 (dry type)																✓	✓✓✓	✓	↔	Green
18mm series	HR1830	1.9	Yellow			Red		Blue		Diamond core 32 ~ 65 (dry type)																✓	✓✓✓	✓	↔	Green
	SDS-plus		Yellow			Red		Blue		Diamond core 32 ~ 65 (dry type)																✓	✓✓✓	✓	↔	Green
20mm series	HR2020	2.6	Yellow			Red		Blue		Diamond core 32 ~ 65 (dry type)																✓	✓✓✓	✓	↔	Green
	SDS-plus		Yellow			Red		Blue		Diamond core 32 ~ 65 (dry type)																✓	✓✓✓	✓	↔	Green
	DHR202	3.5	Yellow			Red		Blue		Diamond core 32 (dry type)																✓	✓✓✓	✓	↔	Green
	SDS-plus		Yellow			Red		Blue		Diamond core 32 (dry type)																✓	✓✓✓	✓	↔	Green
22mm series	HR2230	2.6	Yellow			Red		Blue		Diamond core 32 ~ 65 (dry type)																✓	✓✓✓	✓	↔	Green
	SDS-plus		Yellow			Red		Blue		Diamond core 32 ~ 65 (dry type)																✓	✓✓✓	✓	↔	Green
23mm series	HR2300	2.7	Yellow			Red		Blue		Diamond core 32 ~ 70 (dry type)																✓	✓✓✓	✓	↔	Green
	SDS-plus		Yellow			Red		Blue		Diamond core 32 ~ 70 (dry type)																✓	✓✓✓	✓	↔	Green
	HR2310T	2.9	Yellow			Red		Blue		Diamond core 32 ~ 70 (dry type)																✓	✓✓✓	✓	↔	Green
	SDS-plus		Yellow			Red		Blue		Diamond core 32 ~ 70 (dry type)																✓	✓✓✓	✓	↔	Green
24mm series	HR2460	2.8	Yellow			Red		Blue		Diamond core 32 ~ 65 (dry type)																✓	✓✓✓	✓	↔	Green
	SDS-plus		Yellow			Red		Blue		Diamond core 32 ~ 65 (dry type)																✓	✓✓✓	✓	↔	Green
	HR2470	2.9	Yellow			Red		Blue		Diamond core 32 ~ 65 (dry type)																✓	✓✓✓	✓	↔	Green
	SDS-plus		Yellow			Red		Blue		Diamond core 32 ~ 65 (dry type)																✓	✓✓✓	✓	↔	Green
26mm series	DHR241	3.5	Yellow			Red		Blue		Diamond core 32 (dry type)																✓	✓✓✓	✓	↔	Green
	SDS-plus		Yellow			Red		Blue		Diamond core 32 (dry type)																✓	✓✓✓	✓	↔	Green
	DHR242	3.3	Yellow			Red		Blue		Diamond core 32 ~ 65 (dry type)																✓	✓✓✓	✓	↔	Green
	SDS-plus		Yellow			Red		Blue		Diamond core 32 ~ 65 (dry type)																✓	✓✓✓	✓	↔	Green
28mm series	DHR262	4.5	Yellow			Red		Blue		Diamond core 32 ~ 65 (dry type)																✓	✓✓✓	✓	↔	Green
	SDS-plus		Yellow			Red		Blue		Diamond core 32 ~ 65 (dry type)																✓	✓✓✓	✓	↔	Green
	DHR263	4.7	Yellow			Red		Blue		Diamond core 32 ~ 65 (dry type)																✓	✓✓✓	✓	↔	Green
	SDS-plus		Yellow			Red		Blue		Diamond core 32 ~ 65 (dry type)																✓	✓✓✓	✓	↔	Green
	HR2600 Series	2.8 ~ 2.9	Yellow			Red		Blue		Diamond core 32 ~ 80 (dry type)																✓	✓✓✓	✓	↔	Green
	SDS-plus		Yellow			Red		Blue		Diamond core 32 ~ 80 (dry type)																✓	✓✓✓	✓	↔	Green
30mm series	HR3200 Series	4.8 ~ 5.4	Yellow			Red		Blue		Diamond core 32 ~ 90 (dry type)																✓✓✓	✓✓✓	✓	↔	Green
	SDS-plus		Yellow			Red		Blue		Diamond core 32 ~ 90 (dry type)																✓✓✓	✓✓✓	✓	↔	Green
40mm series	HR4002 / HR4003C	6.6	Yellow			Red		Blue		Diamond core 32 ~ 105																✓✓✓	✓✓✓		↔	Green
	SDS-max		Yellow			Red		Blue		Diamond core 32 ~ 105																✓✓✓	✓✓✓		↔	Green
	HR4013C Series	6.2 ~ 6.8	Yellow			Red		Blue		Diamond core 32 ~ 105																✓✓✓	✓✓✓		↔	Green
	SDS-max		Yellow			Red		Blue		Diamond core 32 ~ 105																✓✓✓	✓✓✓		↔	Green
45mm series	HR4030C	6.9	Yellow			Red		Blue		Diamond core 32 ~ 118																✓✓✓	✓✓✓		↔	Green
	17 HEX		Yellow			Red		Blue		Diamond core 32 ~ 118																✓✓✓	✓✓✓		↔	Green
50mm series	HR4501C Series	8.2 ~ 9.0	Yellow			Red		Blue		Diamond core 32 ~ 125																✓✓✓	✓✓✓		↔	Green
	SDS-max		Yellow			Red		Blue		Diamond core 32 ~ 125																✓✓✓	✓✓✓		↔	Green
50mm series	HR5201C	11.3 ~ 12.2	Yellow			Red		Blue		Diamond core 32 ~ 160																✓✓✓	✓✓✓		↔	Green
	HR5202C Series		Yellow			Red		Blue		Diamond core 32 ~ 160																✓✓✓	✓✓✓		↔	Green
	SDS-max	Yellow			Red		Blue		Diamond core 32 ~ 160																✓✓✓	✓✓✓		↔	Green	
50mm series	HR5212C Series	10.9 ~ 11.9	Yellow			Red		Blue		Diamond core 32 ~ 160																✓✓✓	✓✓✓		↔	Green
	SDS-max		Yellow			Red		Blue		Diamond core 32 ~ 160																✓✓✓	✓✓✓		↔	Green

approx: 50% drilling, 50% chiselling

- Tungsten Carbide-tipped usable range
- Recommended range
- Core bits

- Optimal
- Possible

Carbon Brush List

Carbon Brush	Part Number	Model								
CB-1	181019-9	903								
CB-51	181021-2	1902	3700B	4300BV	6013BR	6016	6300NB			
CB-55 CB-55A	181026-2 B-80248	8416	JR3000V							
CB-64 CB-64A	191627-8 B-80254	6412 GV6010	6413 JV0600K	6510LVR	9035	906	BO3710	BO4540	DP4700	GD0603
CB-65 CB-65A	191628-6 A-81309	6905B	906H	JS1600	JS1670					
CB-70 CB-70A	191914-5 A-81212	6501								
CB-85 CB-85A	191998-3 B-80282	HP1630								
CB-100 CB-100A	181030-1 B-80298	1100	6906	9045B	9215SB	9218SB	9924DB	JN3200	JS3200	PC1100
CB-106 CB-106A	181410-1 A-81290	1911B	3620	RP0900	UT1301					
CB-132	191972-1	UC3520A	UC4020A	UC3541A	UC4041A					
CB-153 CB-153A	181044-0 B-80329	1804N 5008B 9401 LS1216	1805N 5008MG HS0600 LS1219L	2012NB 5016B LF1000 LS1440	2416S 5103N LS1013 N5900B	3501N 5201N LS1016 TW1000	3600H 5401N LS1019L UC3530A	3601B 5402 LS1040 UC3531A	3612BR 6910 LS1212 UC4030A	4107R 9105 LS1214 UC4051A
CB-173	195483-8	VC2510L	VC3210L							
CB-203 CB-203A CB-253	191953-5 B-80341 194547-5	2414NB PC5000C	3612C	HW1200	HW1300	LC1230	LW1400	LW1400	RP1801	
CB-303 CB-303A	191963-2 B-80379	2107F 9227C JN3201J UB1102	4100NH 9237C JR3050T UB1103	4100NH3Z CA5000 JR3060T UT1305	4131 DA4000LR JR3070CT UT2204	5606B GA5010 JS3201J	5740NB GA5020 LS0714	5806B GA6010 PV7000C	9015B HS7010 UB1100	9016B HS7600 UB1101
CB-325	194074-2	9553NB GD0601 HR2601	9556NBG GD0602 HR2610	9556PBG HR2230 HR2611FT	9556HBG HR2300 HR2630	9556HP HR2310T HR2631FT	9557NBG HR2320T HR2800	9563H HR2460 HR2810	GA4040 HR2470	GD0600 HR2600
CB-411 CB-411A CB-415 CB-415A	191940-4 B-80391 191950-1 B-80400	3709 KP0800 6904VH	3901 RT0700C	4403 TD0101F	6922NB TW0200	9031 TW0350	9500NB	9523NB	DS4011	JN1601
CB-419 CB-419A	191962-4 B-80422	4304 FS2700 JS1300	4350CT FS4300 TD0100	9035H HP1620 UH4570X	BO4510H HP2030 UH5570X	BO4556 HP2050 UH6570X	BO5031 HP2070 UH7580X	DA3010F HR1830	FS2300 HR2020	FS2500 HR2440
CB-459	194722-3	GA4030 JS1602	GA4031 PJ7000	GA4034 TM3000C	GA54530 TM3010C	GA4534	GA5030	GA5034	JS1000	JS1601
	3641000	HW111								
	3641160	HW102								
	375009-001	SJ401								
	EIB106C	HB500								
	JM23000123	LH1201FL	LS1018L	MLT100						

Auto Cut - Out Carbon Brush										
CB-105 CB-105A	181038-5 B-80307	HM0810A	HM0810TA	HR2010	HR3520					
CB-155 CB-155A	181048-2 B-80335	HM1201								
CB-204 CB204A	191957-7 B-80357	4112HS GA9010C HM1306	4114S GA9012C HM1810	9617 GA9030 SA7000C	GA7010C GA9030R	GA7012C GA9040S	GA7020 GA9050	GA7030 GS5000	GA7040R HM1302	GA7040S HM1305
CB-218	197129-2	GA7060	GA7060R	GA7061R	GA7062	GA7063R	GA9060	HM1812		
CB-318	191978-9	9563C	GA4040C	GA4041C	GD0800C	PK5001C	PO6000C	PW5001C	SG1250	SG1251J
CB-327	194285-9	HR3000C								
CB-350	194160-9	HK1820	HM0870C	HM0871C	HR3200C	HR4001C	HR4002	HR4003C	HR4003C	HR4030C

Carbon Brush for Cordless Tools										
CB-430	191971-3	8414D DJS101 DUB361	DCS550 DJS161	DCO180 DJV180	BGA450 DPB180	DGA402 DPJ180	DGA452 DSS501	DGD800 BUB360	BHR240 DUC122	DJN161 DHR165
CB-434	193466-2	6932FD	6935FD	BTW121						
CB-440	194427-5	DDA351 DFS450 DHP458 TD091D	DDF442 DFS451 DHP482	DDF444 BHP442 DJS130	BDF450 DHP444 BTD142	BDF452 DHP444 DTD146	DDF456 BHP450 DTP140	DDF458 BHP452 DTW152	DDF482 BHP454 DTW251	DFR550 DHP456 DBN500
CB-441	194435-6	DHR202 DTW450	DHR241	DHS630	DJR181	DJR182	DJR186	DKP180	DLS713	DSS610
CB-442	194928-3	BHR261 DUH651	BHR262	BUC250	BUH550	BUH650	DHR263	DHS710	DUC252	DUC302
CB-448	196854-2	DTW152	DTW251							

Safety Precautions

When using electric tools, basic safety precautions should always be followed to reduce the risk of fire, electric shock, and personal injury, including the following.

/// KEEP WORK AREA CLEAN.

Cluttered areas and benches invite injuries.

/// CONSIDER WORK AREA ENVIRONMENT.

Don't use power tools in damp or wet locations. Keep work area well lit. Don't expose power tools to rain. Don't use power tool in presence of flammable liquids or gases.

/// KEEP CHILDREN AWAY.

All visitors should be kept away from work area. Don't let visitors touch the tool or extension cord.

/// STORE IDLE TOOLS.

When not in use, tools should be stored in a dry, high of locked up place, out of reach of children.

/// DON'T FORCE THE TOOL.

It will do the job better and safer at the rate for which it was intended.

/// USE THE RIGHT TOOL.

Don't force small tools or attachments to do the job of a heavy-duty tool. Don't use tools for purposes not intended.

/// DRESS PROPERLY.

Don't wear loose clothing or jewelry. They can be caught in moving parts. Rubber gloves and non-skid footwear are recommended when working outdoors. Wear protective hair covering to contain long hair.

/// USE SAFETY GLASSES.

Also use face or dust mask if the cutting operation is dusty.

/// DON'T ABUSE THE CORD.

Never carry the tool by the cord or yank it to disconnect it from the socket. Keep the cord away from heat, oil, and sharp edges.

/// SECURE WORK.

Use clamps or a vise to hold the work. It's safer than using your hand and it frees both hands to operate the tool.

/// DON'T OVERREACH.

Keep proper footing and balance at all times.

/// MAINTAIN TOOLS WITH CARE.

Keep cutting tools sharp and clean for better and safer performance. Follow instructions for lubrication and changing accessories. Inspect tool cord periodically and if damaged, have it repaired by an authorized service facility. Inspect extension cords periodically and replace, if damaged. Keep handles dry, clean and free from oil and grease.

/// DISCONNECT TOOLS.

When not in use, before servicing and when changing accessories such as blades, bits and cutters.

/// REMOVE ADJUSTING KEYS AND WRENCHES.

Form the habit of checking to see that keys and adjusting wrenches are removed from the tool before turning it on.

/// AVOID UNINTENTIONAL STARTING.

Don't carry a plugged-in tool with a finger on the switch. Ensure switch is OFF when plugging in.

/// USE OUTDOOR EXTENSION CORDS.

When tool is used outdoors, use only extension cords intended for outdoor use.

/// STAY ALERT.

Watch what you are doing. Use common sense. Don't operate tool when you are tired.

/// CHECK DAMAGED PARTS.

Before further use of the tool, a guard or other part that is damaged should be carefully checked to determine that it will operate properly and perform its intended function. Check for alignment of moving parts, free running of moving parts, breakage of parts, mounting and any other conditions that may affect its operation. A guard or other part that is damaged should be properly repaired or replaced by an authorized service center unless otherwise indicated in this instruction manual. Have defective switches replaced by an authorized service facility. Don't use the tool if the switch does not turn it on and off.

/// GUARD AGAINST ELECTRIC SHOCK.

Avoid body contact with earthed or grounded surfaces (e.g. pipes, radiators, ranges, refrigerators).

/// REPLACEMENT PARTS.

When servicing a tool, use only identical replacement parts.

/// VOLTAGE WARNING:

Before connecting the tool to a power source (receptacle, outlet, etc.) Be sure the voltage supplied is the same as that specified on the nameplate of the tool. A power source with voltage greater than that specified for the tool can result in SERIOUS INJURY to the user V as well as damage to the tool. If in doubt, DO NOT PLUG IN THE TOOL. Using a power source with voltage less than the nameplate rating is harmful to the motor.

Note

- Makita reserves the right to change specifications of parts and accessories without notice.
- Items of standard equipment and specifications may vary by country or area.
- Net weight and dimensions may differ by the type of battery.
- Standard export color for motor housing is Makita industrial green (blue).
- Please state required voltage when ordering. These offers are subject to availability in each country. Actual product color may differ slightly from color reproduced here.
- Weight data in this catalogue is the value measured by us according to EPTA Procedure.

Guarantee

Every Makita tool is thoroughly inspected and tested before leaving the factory. It is guaranteed against defective workmanship and materials. Should any trouble develop, return the COMPLETE tool prepaid to Makita or point of purchase. If inspection shows trouble is caused by defective workmanship of material, all repairs will be made without charge. The guarantee does not apply where repairs have been made or attempted by others; repairs are due to normal wear; the tool has been abused or in an accident; misuse is evident – caused by overloading the tool beyond its capacity, use of the tool after partial failure or use with improper accessories.



TRADEMARKS



Makita Corporation and its affiliates (collectively referred to as "Makita") are the registered owners of the above trademarks and own the exclusive rights to these trademarks. A party who manufactures, advertises, offers for sale, sells, distributes, imports or exports power tools, batteries and/or related accessories using a trademark which is identical or similar to our trademarks may have infringed our trademarks. Makita take a serious view of trademark infringement and will not hesitate to take any legal action against any party who infringes our trademark rights.

Makita Singapore Pte Ltd
7, Changi South Street 3, Singapore 486348
Phone : +65-6546-8700 Fax : +65-6546-8711
Email : msgproductteam@makita.com.sg
Website : www.makita.com.sg
Facebook : www.facebook.com/MakitaSG



RoHS REACH

PRINTED IN SINGAPORE